

TECHNICAL RESEARCH REPORT

Joint Optimal Power Control and Beamforming in Wireless Networks Using Antenna Arrays

by F. Rashid-Farrokhi, L. Tassiulas, K.J.R. Liu

CSHCN T.R. 97-33
(ISR T.R. 97-24)



The Center for Satellite and Hybrid Communication Networks is a NASA-sponsored Commercial Space Center also supported by the Department of Defense (DOD), industry, the State of Maryland, the University of Maryland and the Institute for Systems Research. This document is a technical report in the CSHCN series originating at the University of Maryland.

Web site <http://www.isr.umd.edu/CSHCN/>

Joint Optimal Power Control, and Beamforming in Wireless Networks Using Antenna Arrays

F. Rashid-Farrokhi, L. Tassiulas, and K. J. R. Liu

Electrical Engineering Department and Institute for Systems Research

University of Maryland

College Park, MD 20742, USA

June 18, 1996

ABSTRACT

The interference reduction capability of antenna arrays and the power control algorithms have been considered separately as means to increase the capacity in wireless communication networks. The MVDR (Minimum Variance Distortionless Response) beamformer maximizes the Carrier to Interference Ratio (CIR) when it is employed in the receiver of a wireless link. In a system with omnidirectional antennas, power control algorithms are used to maximize CIR as well. In this paper we consider a system with beamforming capabilities in the receiver, and power control. An iterative algorithm is proposed to jointly update the transmission powers and the beamformer weights so that they converge to the jointly optimal beamforming and transmission power vector. The algorithm is distributed and uses only local interference measurements. In an uplink transmission scenario it is shown how base assignment can be incorporated in addition to beamforming and power control such that a globally optimum solution is obtained. The network capacity increase and the saving in mobile power achieved by beamforming are evaluated through numerical study.

Keywords: Adaptive Beamforming, Power Control, Space Division Multiple Access (SDMA).

This work is supported in part by the NSF grant MIP9457397, NSF grant NCR-9406415, CAREER award NCR-9502614, and AFOSR 95-1-0061.

I. Introduction

Cochannel interference is one of the main impairments that degrades the performance of a wireless link. Power control and antenna beamforming are two approaches for improving the performance in wireless networks by appropriately controlling the cochannel interference.

In power control, the transmitter powers are constantly adjusted by increasing if the Signal to Noise Ratio (SNR) is low and decreasing if the SNR is high, so that the quality of weak links is improved. Receivers employing antenna arrays may adjust their beam patterns such that they have maximum gain towards the directions of their transmitters and minimum gain towards the other directions so that the aggregate interference power is minimized.

Previous work, discussed later in more detail, addressed separately the problems of power control for optimal interference balancing and beamforming to maximize the SNR. In this paper we consider the joint problem. We consider a set of cochannel links, the receivers of which employ antenna arrays, e.g., a set of cochannel uplinks in a cellular network. An algorithm is provided for computing the transmission powers and the beamforming weight vectors, such that a target SNR is achieved for each link (if it is achievable) with minimal total transmission power. The algorithm is decentralized and amenable to a distributed implementation. It operates as follows. For a fixed power allocation, each base station maximizes the CIR using MVDR beamformer. For this fixed beamforming pattern, the mobile powers are updated to reduce the cochannel interference. This operation is done iteratively until both the vector of transmitter powers and the weight coefficients of the beamformers converge to the jointly optimal value. In the case that each transmitter has multiple options regarding which receiver to engage, e.g. each mobile may select its base station among a set of possible options, the algorithm easily extends to find the joint optimum power, base station and beamforming.

The application of antenna arrays has been proposed in [1] to increase network capacity in CDMA systems. This work was based on equal received power from all users in base stations.

In [2]-[5] centralized power control schemes have been proposed to balance the Carrier to Interference Ratio (CIR) or maximize the minimum CIR in all links. These algorithms need global information about all link gains and powers. The distributed power control algorithm which uses only local measurements of CIR was presented in [6]-[9]. In [10] and [11] the combined base station assignment and power allocation was used to increase uplink capacity in wireless communication networks. In those works it was shown that if there exists at least one feasible base station assignment, the proposed algorithms will converge to the optimal base station assignment and power allocation in the sense that it minimizes the interference. Zander has noted [4] in some situations the minimum protection ratio is not achievable by all links. In other words, there is no feasible solution to the power control problem. In [4] he suggested removing a minimum number of links to enable the other links to establish acceptable connections.

The paper is organized as follows. In Section , we describe the system model and existing power control algorithms. Section considers the beamforming problem in a network of users. In Section , we consider power allocation and beamforming as a joint problem. An iterative algorithm for the joint problem is presented which converges to the optimal solution, i.e., the allocated powers are minimum among all sets of feasible power allocations. In Section , we consider an uplink scenario where in addition to power control and beamforming base station assignment is performed as well.

In Section a simulation study is done. We will show that our method increases the capacity in cases when users are uniformly dispersed around the network, and when the users are added in a locally congested area in the network. The simulation results show that using antenna arrays with four elements, the speed of convergence is increased up to three times and the capacity is increased up to five times compared to the case of joint power control and base station assignment with omnidirectional antennas.

II. System Model and Power Control Problem

A set of M transmitter-receiver pairs which share the same channel is considered. The shared channel could be a frequency band in FDMA, a time slot in TDMA, or even CDMA spreading codes. The link gain between transmitter i and receiver j is denoted by G_{ij} , and the i th transmitter power by P_i . For an isotropic antenna with unity gain in all directions, the signal power received at receiver j from transmitter i is $G_{ij}P_i$, as illustrated in Fig. 1. It is assumed that transmitter i communicates with receiver i . Hence the desired signal at receiver i is equal to $G_{ii}P_i$, while the interfering signal power from other transmitters to receiver i is $I = \sum_{j \neq i} G_{ji}P_j$. The CIR at the i th receiver is given by

$$\Gamma_i = \frac{G_{ii}P_i}{\sum_{j \neq i} G_{ji}P_j}.$$

If we neglect thermal noise, the quality of the transmission link from transmitter i to receiver j depends solely on Γ_i . The quality is acceptable if Γ_i is above a certain threshold γ_0 , the *system protection ratio*, which is determined based on the signaling scheme and the link quality requirements (target bit error rate). Hence for acceptable link quality,

$$\frac{G_{ii}P_i}{\sum_{j \neq i} G_{ji}P_j} \geq \gamma_0. \quad (1)$$

In matrix form, (1) can be written as follows,

$$\frac{1}{\gamma_0} \mathbf{P} \geq F \mathbf{P}, \quad (2)$$

where $\mathbf{P} = [P_1, P_2, \dots, P_M]^T$, is the power vector, and F is a non-negative matrix defined as

$$F_{ij} = \begin{cases} 0 & \text{if } j = i \\ \frac{G_{ji}}{G_{ii}} > 0 & \text{if } j \neq i \end{cases}.$$

The objective of a power control scheme is to maintain the link quality by keeping the CIR above the threshold γ_0 , that is, to adjust the power vector \mathbf{P} such that (2) is satisfied. This problem has been studied extensively recently [2]-[11]. Given that F is irreducible, it is

known by Perron-Frobenius theorem, that the maximum value of γ_0 for which there exists a positive \mathbf{P} such that (2) is satisfied is $\frac{1}{\rho(F)}$, where $\rho(F)$ is the spectral radius of F [12]. According to this theorem, the power vector that satisfies (2) is the eigenvector corresponding to $\rho(F)$ and is positive. Considering the thermal noise at the receivers, the CIR at the i th receiver is modified as

$$\Gamma_i = \frac{G_{ii}P_i}{\sum_{j \neq i} G_{ji}P_j + N_i},$$

where N_i is noise power at the i th receiver. The requirement for acceptable link quality is again

$$\Gamma_i \geq \gamma_0, \quad 1 \leq i \leq M,$$

or in matrix form

$$[I - \gamma_0 F] \mathbf{P} \geq \mathbf{u}, \quad (3)$$

where I is an $M \times M$ identity matrix, and \mathbf{u} is an element-wise positive vector with elements u_i defined as

$$u_i = \frac{\gamma_0 N_i}{G_{ii}}, \quad 1 \leq i \leq M.$$

The CIR threshold γ_0 is achievable if there exists at least one solution vector \mathbf{P} that satisfies (3). The power control problem now is as follows:

$$\begin{aligned} & \text{minimize} && \sum P_i, \\ & \text{subject to} && [I - \gamma_0 F] \mathbf{P} \geq \mathbf{u}. \end{aligned}$$

It can be shown that if the spectral radius of F is less than $\frac{1}{\gamma_0}$, the matrix $I - \gamma_0 F$ is invertible and positive [12]. In this case the power vector

$$\hat{\mathbf{P}} = [I - \gamma_0 F]^{-1} \mathbf{u} \quad (4)$$

solves the optimization problem.

A centralized power control algorithm ([4]-[5]) solves (4) by requiring all link gains in the network and noise levels at receivers. In [6]-[8] a decentralized solution to the power control problem is proposed that solves (4) by performing the iterations

$$\mathbf{P}^{n+1} = \gamma_0 F \mathbf{P}^n + \mathbf{u}. \quad (5)$$

The right hand side of (5) is a function of the interference at the i th receiver, and the link gain between each receiver and its transmitter. That is, there is no need to know all the existing path gains and transmitter powers in order to update the powers. At each iteration, transmitters update their powers based on the interference measured at the receivers and the link gain between each transmitter and its own receiver, which can be measured from the information sent in the control channel. It has been shown in [6]-[8] that starting from any arbitrary power vector, this solution converges to the optimal solution $\hat{\mathbf{P}}$.

III. Antenna Array and Beamforming

An antenna array consists of a set of antennas, designed to receive signals radiating from some specific directions and attenuate signals radiating from other directions of no interest. The outputs of array elements are weighted and added by a beamformer as shown in Fig. 2 to produce a directed main beam and adjustable nulls. In order to reject the interferences, the beamformer has to place its nulls in the directions of sources of interference, and steer to the direction of the target signal by maintaining constant gain at this direction. A sample antenna array pattern, which is depicted in Fig. 3 shows this effect.

Assume the array consists of $K + 1$ elements, and its response at the direction of arrival θ is $\mathbf{a}(\theta) = [a_0(\theta), a_1(\theta), \dots, a_K(\theta)]$, where $a_k(\theta)$ is the response of the k th antenna element to the signal $s(t)$ from direction θ . The signal vector received due to $s(t)$ can be written as

$$\mathbf{x}(t) = \mathbf{a}(\theta) \sqrt{P} s(t),$$

where P is the received power of the source. The $(K + 1) \times 1$ vector $\mathbf{a}(\theta)$ is called the *spatial signature* or *array response* for the source at direction θ .

Now consider a cochannel set consisting of M transmitter and receiver pairs. Denote the i th array response to the j th source by \mathbf{a}_{ji} . The received signal at the i th receiver can be written as follows

$$\mathbf{x}_i(t) = \sum_{j=1}^M \sqrt{P_j} s_j(t) \mathbf{a}_{ji} + \mathbf{n}_i(t),$$

where $\mathbf{n}_i(t)$ is the thermal noise vector at the input of antenna array at the i th receiver, and P_j is the power of the j th transmitter. Consider the problem of beamforming as to maximize CIR for a specific link, which is equivalent to minimizing the interference at the receiver of that link. In order to minimize the interference, we minimize the variance or average power at the output of the beamformer subject to maintaining unity gain at the direction of the desired signal. We can write the output of the beamformer at the i th receiver as

$$\mathbf{e}_i = \mathbf{w}_i^H \mathbf{x}_i,$$

where \mathbf{w}_i and \mathbf{x}_i are the beamforming weight vector and the received signal vector at the i th receiver, respectively. The average output power is given by

$$\mathcal{E}_i = \mathbb{E}\{\mathbf{w}_i^H \mathbf{x}_i \mathbf{x}_i^H \mathbf{w}_i\} = \mathbf{w}_i^H \mathbb{E}\{\mathbf{x}_i \mathbf{x}_i^H\} \mathbf{w}_i = \mathbf{w}_i^H \Phi_i \mathbf{w}_i, \quad (6)$$

where Φ_i is the correlation matrix of the received vector \mathbf{x}_i . If the message signals $s_j(t)$ are orthogonal to each other, the correlation matrix Φ_i is given by [13]

$$\begin{aligned} \Phi_i &= \sum_{j \neq i} P_j G_{ji} \mathbf{a}_{ji} \mathbf{a}_{ji}^H + N_i I + P_i G_{ii} \mathbf{a}_{ii} \mathbf{a}_{ii}^H \\ &= \Phi_{in} + P_i G_{ii} \mathbf{a}_{ii} \mathbf{a}_{ii}^H, \end{aligned} \quad (7)$$

where

$$\Phi_{in} = \sum_{j \neq i} P_j G_{ji} \mathbf{a}_{ji} \mathbf{a}_{ji}^H + N_i I$$

is the correlation matrix of unwanted signals, and N_i is the noise power at the input of each array element. Combining (6) and (7), we obtain the received signal plus interference power as a function of weight vector \mathbf{w}_i :

$$\mathcal{E}_i = P_i G_{ii} + N_i \mathbf{w}_i^H \mathbf{w}_i + \sum_{j \neq i} P_j G_{ji} \mathbf{w}_i^H \mathbf{a}_{ji} \mathbf{a}_{ji}^H \mathbf{w}_i. \quad (8)$$

Here we use the fact that the gain at the direction of interest is unity, i.e., $\mathbf{w}_i^H \mathbf{a}_{ii} = 1$. The first term in (8) is the received power from the signal of interest, while the other terms are related to the interference and noise. Therefore the total interference is given by

$$I_i = \sum_{j \neq i} G_{ji} \mathbf{w}_i^H \mathbf{a}_{ji} \mathbf{a}_{ji}^H \mathbf{w}_i P_j + N_i \mathbf{w}_i^H \mathbf{w}_i.$$

The goal of beamforming is to find a weight vector $\hat{\mathbf{w}}_i$ that minimizes the interference I_i subject to $\hat{\mathbf{w}}_i^H \mathbf{a}_{ii} = 1$. It can be shown that the solution is [14]

$$\hat{\mathbf{w}}_i = \frac{\Phi_i^{-1} \mathbf{a}_{ii}}{\mathbf{a}_{ii}^H \Phi_i^{-1} \mathbf{a}_{ii}}. \quad (9)$$

The antenna gain at the direction of interest is unity, that is, the received desired signal is unaffected by beamforming. Therefore, the CIR at the i th receiver is given by

$$\Gamma_i = P_i G_{ii} \mathbf{a}_{ii}^H \Phi_{in}^{-1} \mathbf{a}_{ii}.$$

In order to calculate the received power for transmitter j , we have to multiply the transmitter power by the antenna power gain in addition to the propagation path gain, i.e.,

$$G_{ji} G_{a_i}(\mathbf{w}_i, \mathbf{a}_{ji}),$$

where $G_{a_i}(\mathbf{w}_i, \mathbf{a}_{ji}) = \mathbf{w}_i^H \mathbf{a}_{ji} \mathbf{a}_{ji}^H \mathbf{w}_i$. Then the maximum CIR at the i th receiver can be written as

$$\Gamma_i = \frac{P_i G_{ii}}{\sum_{j \neq i} G_{ji} G_{a_i}(\hat{\mathbf{w}}_i, \mathbf{a}_{ji}) P_j + N_i \hat{\mathbf{w}}_i^H \hat{\mathbf{w}}_i}. \quad (10)$$

Here we assumed that the array response to the source of interest is known. The array response is obtained by the estimation of the *direction of arrival* (DOA). But in wireless networks usually the number of cochannels is much larger than the number of array elements. Therefore, conventional DOA estimation methods like ESPRIT and MUSIC are not applicable. However, there exist several schemes that can be used to estimate the array response in TDMA ([15]), FDMA ([16]), and CDMA networks ([13]), without estimating the DOA.

IV. Jointly Optimal Power Control and Beamforming

In the joint power control and beamforming problem the objective is to find the optimal weight vector and power allocations such that the CIR threshold is achieved by all links, while each transmitter keeps the transmission power at the minimum required level to reduce the interference to other users. The CIR at the i th receiver is given by

$$\Gamma_i = \frac{P_i G_{ii}}{\sum_{j \neq i} G_{ji} G_{a_i}(\mathbf{w}_i, \mathbf{a}_{ji}) P_j + N_i \mathbf{w}_i^H \mathbf{w}_i}.$$

The optimization problem now is defined as

$$\begin{aligned} \min_{\mathbf{w}, \mathbf{P}} \quad & \sum_{i=1}^M P_i \\ \text{subject to} \quad & \Gamma_i \geq \gamma_0, \quad (i = 1, 2, \dots, M). \end{aligned} \quad (11)$$

This constraint can be presented in matrix form as:

$$[I - \gamma_0 F^W] \mathbf{P} \geq \mathbf{u},$$

where

$$[F^W]_{ij} = \begin{cases} 0 & \text{if } j = i \\ \frac{G_{ji} G_{a_i}(\mathbf{w}_i, \mathbf{a}_{ji})}{G_{ii}} > 0 & \text{otherwise} \end{cases},$$

and \mathbf{u} is an element-wise positive vector with elements u_i defined as

$$u_i = \frac{N_i \mathbf{w}_i^H \mathbf{w}_i}{G_{ii}}, \quad (i = 1, 2, \dots, M).$$

Assume that there is a set of weight vectors $\mathbf{W} = \{\mathbf{w}_1, \mathbf{w}_2, \dots, \mathbf{w}_M\}$, for which $\rho(F^W) < \frac{1}{\gamma_0}$. The matrix $I - \gamma_0 F^W$ is then invertible and $\mathbf{P}_w = [I - \gamma_0 F^W]^{-1} \mathbf{u}$ minimizes the objective function in the optimization problem for the fixed weight vector set \mathbf{W} . For any feasible pair $(\mathbf{W}, \mathbf{P}_w)$, the vector \mathbf{P}_w , can be computed as the limit of the following iteration

$$P_i^{n+1} = \gamma_0 \sum_{k \neq i} \frac{G_{ki} G_{a_i}(\mathbf{w}_i, \mathbf{a}_{ki})}{G_{ii}} P_k^n + \frac{\gamma_0 N_i \mathbf{w}_i^H \mathbf{w}_i}{G_{ii}}, \quad (i = 1, 2, \dots, M). \quad (12)$$

The above iteration is the same as the distributed power control algorithm (see [6]-[9]), in which the path gain G_{ki} is replaced by the multiplication of the path gain and antenna gain, and the noise power is replaced by the weighted sum of the noise powers at the input of each antenna array. Denote the iteration in (12) as

$$\mathbf{P}^n = m^w(\mathbf{P}^{n-1}).$$

Starting from any initial power vector \mathbf{P}^0 , the mapping m^w will converge to the optimal power vector \mathbf{P}_w which is the fixed point of the mapping, i.e., $\lim_{n \rightarrow \infty} \mathbf{P}^n = \mathbf{P}_w$, $\mathbf{P}_w = m^w(\mathbf{P}_w)$. The objective in joint optimal beamforming and power control problem is to find the beamforming set W among all feasible beamforming sets, in such a way that \mathbf{P}_w is minimal.

The level of cochannel interference depends both on the gain between interfering transmitters and receivers, as well as on the level of transmitter powers, i.e., the optimal beamforming vector may vary for different powers. Hence, beamforming and power control should be considered jointly.

Let $(\hat{\mathbf{W}}, \hat{\mathbf{P}})$ be the weight vector and power vector pair which achieves the minimum in (11). In the sequel, we present an iterative algorithm for adjusting \mathbf{P} and \mathbf{W} simultaneously, and we will show that, starting from any arbitrary power vector, it converges to the optimal solution $(\hat{\mathbf{W}}, \hat{\mathbf{P}})$. The iteration step for obtaining $(\mathbf{P}^{n+1}, \mathbf{W}^{n+1})$ given $(\mathbf{P}^n, \mathbf{W}^n)$ is as follows:

Algorithm A:

1. \mathbf{w}_i^{n+1} is computed at each receiver i such that the cochannel interference is minimized

under the condition of constant gain for the direction of interest, i.e.,

$$\mathbf{w}_i^{n+1} = \arg \min_{\mathbf{w}_i} \left\{ \sum_{j \neq i} G_{ji} G_{a_i}(\mathbf{w}_i, \mathbf{a}_{ji}) P_j^n + N_i \mathbf{w}_i^H \mathbf{w}_i \right\}, \quad (i = 1, 2, \dots, M),$$

$$\text{subject to} \quad \mathbf{w}_i^H \mathbf{a}_{ii} = 1,$$

where \mathbf{P}^n is the power vector updated at step n .

2. The updated power vector, \mathbf{P}^{n+1} , is then obtained by

$$P_i^{n+1} = \gamma_0 \sum_{k \neq i} \frac{G_{ki} G_{a_i}(\mathbf{w}_i^{n+1}, \mathbf{a}_{ki})}{G_{ii}} P_k^n + \frac{\gamma_0 N_i (\mathbf{w}_i^{n+1})^H \mathbf{w}_i^{n+1}}{G_{ii}},$$

that is, by performing one iteration with the mapping $m^{\mathbf{w}_i^{n+1}}$ on the power vector \mathbf{P}^n .

Combining two iteration steps in the algorithm, we obtain the power vector update in a single step:

$$P_i^{n+1} = \min_{\mathbf{w}_i} \left\{ \gamma_0 \sum_{k \neq i} \frac{G_{ki} G_{a_i}(\mathbf{w}_i, \mathbf{a}_{ki})}{G_{ii}} P_k^n + \frac{\gamma_0 N_i \mathbf{w}_i^H \mathbf{w}_i}{G_{ii}} \right\},$$

$$\text{subject to} \quad \mathbf{w}_i^H \mathbf{a}_{ii} = 1. \quad (13)$$

We denote the iteration in (13) as

$$\mathbf{P}^{n+1} = m(\mathbf{P}^n).$$

Theorem 1: The sequence $(\mathbf{P}^n, \mathbf{W}^n)$, $(n = 1, 2, \dots)$ produced by the iteration (13), starting from an arbitrary pair $(\mathbf{P}^0, \mathbf{W}^0)$, converges to the optimal pair $(\hat{\mathbf{P}}, \hat{\mathbf{W}})$.

In order to prove theorem 1, it is shown first that the theorem holds when the iteration starts from the power vector $\mathbf{P}^0 = 0$.

Lemma 1: For any two power vectors \mathbf{P}_A and \mathbf{P}_B such that $\mathbf{P}_A \leq \mathbf{P}_B$ the following holds:

- (a) $m(\mathbf{P}_A) \leq m^w(\mathbf{P}_A), \quad \forall \mathbf{w}$
- (b) $m^w(\mathbf{P}_A) \leq m^w(\mathbf{P}_B), \quad \forall \mathbf{w}$
- (c) $m(\mathbf{P}_A) \leq m(\mathbf{P}_B)$

Proof: (b) and (c) can be concluded immediately from the fact that the coefficients in the mappings m and $m^{\hat{w}}$ are positive. (a) holds since in the mapping m , we are minimizing the power vector \mathbf{P} over all possible weight vectors \mathbf{w} .

□

Theorem 2: The sequence \mathbf{P}^n by iteration (13) and initial condition $\mathbf{P}^0 = 0$, converges to the fixed point of the mapping m , $\hat{\mathbf{P}}$.

Proof: We define two power vector sequences \mathbf{P}^n and $\mathbf{P}_{\hat{w}}^n$ produced by the mappings m and $m^{\hat{w}}$, respectively, with zero initial condition. That is,

$$\mathbf{P}^{n+1} = m(\mathbf{P}^n), \quad \mathbf{P}^0 = 0,$$

and

$$\mathbf{P}_{\hat{w}}^{n+1} = m^{\hat{w}}(\mathbf{P}_{\hat{w}}^n), \quad \mathbf{P}_{\hat{w}}^0 = 0.$$

The power vector sequence \mathbf{P}^n is non-decreasing. In order to show this we observe that $\mathbf{P}^1 = m(\mathbf{P}^0) = \mathbf{u} \geq 0$, i.e., $\mathbf{P}^0 \leq \mathbf{P}^1$, and if $\mathbf{P}^{n-1} \leq \mathbf{P}^n$ lemma 1(c) implies $m(\mathbf{P}^{n-1}) \leq m(\mathbf{P}^n)$ or $\mathbf{P}^n \leq \mathbf{P}^{n+1}$. By induction we conclude that \mathbf{P}^n is a non-decreasing sequence. We can follow the same steps to prove that the sequence $\mathbf{P}_{\hat{w}}^n$ is also non-decreasing.

We start the mappings m and $m^{\hat{w}}$ from the same starting vector $\mathbf{P}^0 = \mathbf{P}_{\hat{w}}^0 = 0$. By lemma 1(a) $m(\mathbf{P}^0) \leq m^{\hat{w}}(\mathbf{P}_{\hat{w}}^0)$ or $\mathbf{P}^1 \leq \mathbf{P}_{\hat{w}}^1$, and if $\mathbf{P}^n \leq \mathbf{P}_{\hat{w}}^n$, by lemma 1(a),(b) $m(\mathbf{P}^n) \leq m^{\hat{w}}(\mathbf{P}_{\hat{w}}^n)$ or $\mathbf{P}^{n+1} \leq \mathbf{P}_{\hat{w}}^{n+1}$ for all n . That is, by induction we may write $\mathbf{P}^n \leq \mathbf{P}_{\hat{w}}^n$, (for $n = 1, 2, \dots$). Since \hat{W} is the optimal beamforming set, the sequence $\mathbf{P}_{\hat{w}}^n$ will converge to the optimal power vector $\hat{\mathbf{P}}$, i.e.,

$$\lim_{n \rightarrow \infty} \mathbf{P}_{\hat{w}}^n = \hat{\mathbf{P}}.$$

Hence \mathbf{P}^n is a non-decreasing sequence and it is bounded from above by $\hat{\mathbf{P}}$, so it has a limit denoted by \mathbf{P}^* . It is shown in the following that $\mathbf{P}^* = \hat{\mathbf{P}}$. Since \mathbf{P}^n approaches \mathbf{P}^* from below we can write $\mathbf{P}^n = \mathbf{P}^* + \epsilon^n$, where $\epsilon^n = \mathbf{P}^n - \mathbf{P}^*$ is non-positive and approaches zero. Now we show \mathbf{P}^* is the fixed point of the mapping m . Since $\epsilon < 0$, $\mathbf{P}^{n+1} = m(\mathbf{P}^n)$ implies:

$$\begin{aligned}
P_i^{n+1} &= \min_{\mathbf{w}_i} \left\{ \gamma_0 \sum_{k \neq i} \frac{G_{ki} G_{a_i}(\mathbf{w}_i, \mathbf{a}_{ki})}{G_{ii}} (P_k^* + \epsilon_k^n) + \frac{\gamma_0 N_i \mathbf{w}_i^H \mathbf{w}_i}{G_{ii}} \right\} \\
&= \min_{\mathbf{w}_i} \left\{ \gamma_0 \sum_{k \neq i} \frac{G_{ki} G_{a_i}(\mathbf{w}_i, \mathbf{a}_{ki})}{G_{ii}} P_k^* + \frac{\gamma_0 N_i \mathbf{w}_i^H \mathbf{w}_i}{G_{ii}} + \gamma_0 \sum_{k \neq i} \frac{G_{ki} G_{a_i}(\mathbf{w}_i, \mathbf{a}_{ki})}{G_{ii}} \epsilon_k^n \right\} \\
&\leq \min_{\mathbf{w}_i} \left\{ \gamma_0 \sum_{k \neq i} \frac{G_{ki} G_{a_i}(\mathbf{w}_i, \mathbf{a}_{ki})}{G_{ii}} P_k^* + \frac{\gamma_0 N_i \mathbf{w}_i^H \mathbf{w}_i}{G_{ii}} \right\}
\end{aligned} \tag{14}$$

Also $\mathbf{P}^{n+1} = \mathbf{P}^* + \epsilon^{n+1}$, concludes that $\mathbf{P}^* + \epsilon^{n+1} \leq m(\mathbf{P}^*)$.

Since ϵ^{n+1} approaches zero,

$$\mathbf{P}^* \leq m(\mathbf{P}^*). \tag{15}$$

Again from $\mathbf{P}^{n+1} = m(\mathbf{P}^n)$, we conclude:

$$\begin{aligned}
P_i^{n+1} &= \min_{\mathbf{w}_i} \left\{ \gamma_0 \sum_{k \neq i} \frac{G_{ki} G_{a_i}(\mathbf{w}_i, \mathbf{a}_{ki})}{G_{ii}} (P_k^* + \epsilon_i^n) + \frac{\gamma_0 N_i \mathbf{w}_i^H \mathbf{w}_i}{G_{ii}} \right\} \\
&\geq \min_{\mathbf{w}_i} \left\{ \gamma_0 \sum_{k \neq i} \frac{G_{ki} G_{a_i}(\mathbf{w}_i, \mathbf{a}_{ki})}{G_{ii}} P_k^* + \frac{\gamma_0 N_i \mathbf{w}_i^H \mathbf{w}_i}{G_{ii}} \right\} + \min_{\mathbf{w}_i} \left\{ \gamma_0 \sum_{k \neq i} \frac{G_{ki} G_{a_i}(\mathbf{w}_i, \mathbf{a}_{ki})}{G_{ii}} \epsilon_k^n \right\} \\
&\geq m_i(\mathbf{P}^*) + \hat{m}_i(\epsilon^n),
\end{aligned} \tag{16}$$

where

$$\hat{m}_i(\epsilon^n) = \min_{\mathbf{w}_i} \left\{ \gamma_0 \sum_{k \neq i} \frac{G_{ki} G_{a_i}(\mathbf{w}_i, \mathbf{a}_{ki})}{G_{ii}} \epsilon_k^n \right\}.$$

Consequently,

$$\mathbf{P}^* + \epsilon^{n+1} \geq m(\mathbf{P}^*) + \hat{m}(\epsilon^n).$$

$\hat{m}(\epsilon^n)$ and ϵ^n both approach zero, therefore

$$\mathbf{P}^* \geq m(\mathbf{P}^*). \tag{17}$$

Finally from (15) and (17), $\mathbf{P}^* = m(\mathbf{P}^*)$.

Let

$$\check{\mathbf{w}}_i^n = \arg \min_{\mathbf{w}_i} \left\{ \sum_{j \neq i} G_{ji} G_{a_i}(\mathbf{w}_i, \mathbf{a}_{ji}) P_j^* + N_i \mathbf{w}_i^H \mathbf{w}_i \right\}, \quad (i = 1, 2, \dots, M),$$

subject to $\mathbf{w}_i^H \mathbf{a}_{ii} = 1$,

and

$$P_i^* = \left\{ \gamma_0 \sum_{k \neq i} \frac{G_{ki} G_{a_i}(\check{\mathbf{w}}_i, \mathbf{a}_{ki})}{G_{ii}} P_k^* + \frac{\gamma_0 N_i (\check{\mathbf{w}}_i)^H \check{\mathbf{w}}_i}{G_{ii}} \right\}.$$

By definition $\check{\mathbf{w}}_i = \hat{\mathbf{w}}_i$ and consequently $\mathbf{P}^* = \hat{\mathbf{P}}$. That is, the sequence \mathbf{P}^n converges to the optimal power vector $\hat{\mathbf{P}}$. Furthermore, the weight vectors converge to the optimal beamforming.

□

Proof of theorem 1: Now we will show that a power vector sequence starting from any initial power vector converges to the optimal power vector $\hat{\mathbf{P}}$. We consider the sequence $\tilde{\mathbf{P}}^{n+1} = m(\tilde{\mathbf{P}}^n)$ with the arbitrary initial power vector $\tilde{\mathbf{P}}^0$.

Assume there exists a feasible pair $(\hat{\mathbf{P}}, \hat{\mathbf{W}})$. The power vector iteration for this pair is given by

$$\mathbf{P}_{\hat{\mathbf{w}}}^{n+1} = m^{\hat{\mathbf{w}}}(\mathbf{P}_{\hat{\mathbf{w}}}^n), \quad (n = 0, 1, \dots). \quad (18)$$

The optimality of $\hat{\mathbf{W}}$ implies that $\lim_{n \rightarrow \infty} \mathbf{P}_{\hat{\mathbf{w}}}^n = \hat{\mathbf{P}}$, where $\hat{\mathbf{P}}$ is the fixed point of the mapping defined in (18). Assume that both sequences start from the same point, i.e., $\tilde{\mathbf{P}}^0 = \mathbf{P}_{\hat{\mathbf{w}}}^0$. Lemma 1(c) implies $m(\tilde{\mathbf{P}}^0) \leq m^{\hat{\mathbf{w}}}(\mathbf{P}_{\hat{\mathbf{w}}}^0)$ or $\tilde{\mathbf{P}}^1 \leq \mathbf{P}_{\hat{\mathbf{w}}}^1$. If $\tilde{\mathbf{P}}^n \leq \mathbf{P}_{\hat{\mathbf{w}}}^n$, then $m(\tilde{\mathbf{P}}^n) \leq m^{\hat{\mathbf{w}}}(\mathbf{P}_{\hat{\mathbf{w}}}^n)$ or $\tilde{\mathbf{P}}^{n+1} \leq \mathbf{P}_{\hat{\mathbf{w}}}^{n+1}$. Hence by induction we have

$$\tilde{\mathbf{P}}^n \leq \mathbf{P}_{\hat{\mathbf{w}}}^n, \quad (n = 0, 1, \dots).$$

and since $\lim_{n \rightarrow \infty} \mathbf{P}_{\hat{w}}^n = \hat{\mathbf{P}}$, we have $\tilde{\mathbf{P}}^n \leq \hat{\mathbf{P}}$, ($n = 0, 1, \dots$). That is, the sequence $\tilde{\mathbf{P}}^n$ is bounded, therefore it has accumulation points. For any accumulation point $\tilde{\mathbf{P}}^*$ the following inequality holds:

$$\tilde{\mathbf{P}}^* \leq \hat{\mathbf{P}}. \quad (19)$$

Let the sequence $\check{\mathbf{P}}^n$ defined by the iteration $\check{\mathbf{P}}^n = m(\check{\mathbf{P}}^{n-1})$ start from $\check{\mathbf{P}}^0 = 0$. Lemma 1(c) implies $m(\check{\mathbf{P}}^0) \leq m(\tilde{\mathbf{P}}^0)$, that is $\check{\mathbf{P}}^1 \leq \tilde{\mathbf{P}}^1$. If $\check{\mathbf{P}}^n \leq \tilde{\mathbf{P}}^n$, then $m(\check{\mathbf{P}}^n) \leq m(\tilde{\mathbf{P}}^n)$ or $\check{\mathbf{P}}^{n+1} \leq \tilde{\mathbf{P}}^{n+1}$. By induction we may write

$$\check{\mathbf{P}}^n \leq \tilde{\mathbf{P}}^n, \quad (n = 0, 1, \dots).$$

The sequence $\check{\mathbf{P}}$ converges to $\hat{\mathbf{P}}$, therefore for the accumulation points we have

$$\check{\mathbf{P}}^* = \hat{\mathbf{P}} \leq \tilde{\mathbf{P}}^* \quad (20)$$

The inequalities (19) and (20) imply that $\tilde{\mathbf{P}}^* = \hat{\mathbf{P}}$.

□

V. Joint Power Control, Base Station Assignment, and Beamforming

So far we have considered the power control problem for a number of transmitter-receiver pairs with fixed assignment, which can be used in uplink or downlink in mobile communication systems. In the uplink power control problem without beamforming, the power allocation and base station assignment can be integrated to attain higher capacity, while achieving smaller power allocated to each mobile as it has been demonstrated in previous studies, [10], [11].

In the joint power control and base station assignment, a number of base stations are potential receivers of a mobile transmitter. In the optimal power control and base station assignment, the objective is to determine the assignment of users to base stations which

minimizes the allocated mobile powers, and the corresponding transmission powers. Iterative algorithms that compute the optimal joint base station and power assignment were proposed in [10], [11].

In an uplink scenario where mobiles access base stations equipped with array antennas, the problem of joint power control and beamforming as well as base station assignment naturally arises. A modification of the iterative algorithm we proposed for the joint power control and beamforming problem can perform base assignment as well. The iterative step of the algorithm is as follows:

Algorithm B

1. Each base station in the allowable set of a mobile i minimizes the total interference subject to maintaining unity gain towards the direction of this mobile:

$$\mathbf{w}_{im}^{n+1} = \arg \min_{\mathbf{w}_i} \left\{ \sum_{j \neq m} G_{jm} G_{a_i}(\mathbf{w}_i, \mathbf{a}_{jm}) P_j^n + N_m \mathbf{w}_i^H \mathbf{w}_i \right\}, \quad (i = 1, 2, \dots, M),$$

$m \in B_i,$

subject to $\mathbf{w}_i^H \mathbf{a}_{im} = 1,$

where \mathbf{w}_{im}^{n+1} is the optimal beamforming weight vector at the m th base station for the i th mobile, and B_i is the set of allowable base stations for the i th mobile.

2. Each mobile finds the optimal base station such that the allocated power for the next iteration is minimized:

$$b_i = \arg \min_{m \in B_i} \left\{ \gamma_0 \sum_{k \neq i} \frac{G_{km} G_{a_i}(\mathbf{w}_{im}^{n+1}, \mathbf{a}_{km})}{G_{im}} P_k^n + \frac{\gamma_0 N_m \mathbf{w}_{im}^{n+1 H} \mathbf{w}_{im}^{n+1}}{G_{im}} \right\}, \quad (i = 1, 2, \dots, M),$$

where b_i is the optimal assignment for mobile i .

3. The mobile i updates the power based on the optimum beamforming and base station assignment:

$$P_i^{n+1} = \gamma_0 \sum_{k \neq i} \frac{G_{kb_i} G_{a_i}(\mathbf{w}_{ib_i}^{n+1}, \mathbf{a}_{kb_i})}{G_{ib_i}} P_k^n + \frac{\gamma_0 N_{b_i} \mathbf{w}_{ib_i}^{n+1 H} \mathbf{w}_{ib_i}^{n+1}}{G_{ib_i}}, \quad (i = 1, 2, \dots).$$

The above steps are combined in one iteration as

$$P_i^{n+1} = \min_{\mathbf{w}_{im}, m \in B_i} \left\{ \gamma_0 \sum_{k \neq i} \frac{G_{km} G_{a_i}(\mathbf{w}_{im}, \mathbf{a}_{km})}{G_{im}} P_k^n + \frac{\gamma_0 N_m \mathbf{w}_{im}^H \mathbf{w}_{im}}{G_{im}} \right\}, \quad (i = 1, 2, \dots, M),$$

subject to $G_{a_i}(\mathbf{w}_{im}, \mathbf{a}_{im}) = 1$.

The convergence and optimality of this algorithm can also be proved following the same steps as in Section . The only difference is that the minimization is done over all beamforming vectors and base station assignments instead of over the beamforming vectors only. The proof is omitted here for brevity.

VI. Simulation Results and Comparisons

We evaluate the performance of our algorithm by simulating the same system as in [11]. The quality constraint is considered to be 0.0304, which is equivalent to CIR of -14 dB. This threshold results in acceptable bit error rate only in CDMA systems where there is a processing gain of the order of 128 or more. However, the same methodology can be applied to any wireless network such as TDMA and FDMA. In the latter cases the interference rejection capability of antenna arrays can be utilized to decrease the reuse distance, or support more than one user with the same time slot or frequency in each cell. Both of these effects will increase the capacity significantly.

Fig. 4 shows a network with 36 base stations with 400 users randomly distributed in the area $[0.5, 6.5] \times [0.5, 6.5]$ with uniform distribution. The link gain is modeled as $G_{ij} = 1/d_{ij}^4$, where d_{ij} is the distance between base i and mobile j . The shadow fading is ignored in these simulations. Throughout the simulations, we consider two system setups: in system setup I we use omnidirectional antennas; in system setup II we use antenna array with 4 elements.

Fig. 4(a), illustrates the use of system setup I. Traditionally, the mobiles are assigned to the base stations with the largest path gains, and the mobile powers are obtained by iterative fixed assignment power control algorithm as given by (5). In Fig. 5(a), the dashdot

curve shows the total mobile power at each iteration. This algorithm converges in about 16 iterations. In Fig. 4(b), using the same system setup, the base station assignment is done by the jointly optimal base station assignment and power control algorithm, and mobiles have the option to select among four closest base stations [11]. The total mobile power is depicted in Fig. 5(a). The dashed curves shows that the total power is slightly less than that of the first algorithm considered in Fig. 4(a). This algorithm converges in about 15 iterations. In Fig. 4(c) we use the system setup II, i.e., the base stations are equipped with 4-element antenna arrays. We apply our joint power control, base station assignment, and beamforming algorithm to the same configuration of users as in Fig. 4(a) and (b). The solid curve in Fig. 5(a) shows that the total mobile power is an order of magnitude smaller than the previous algorithms. Furthermore, the convergence of this algorithm is much faster; it converges in about 5 iterations in our simulation study.

The capacity of the system is defined as the maximum number of users for which there exists a feasible power vector. As the number of users is increased the maximum eigenvalue of the gain matrix $\rho(F)$ approaches unity and the total sum of mobile power is increased. At the same time the number of iterations in order to achieve the convergence is increased. Therefore, in our simulations, instead of setting a maximum value for the power elements, we set a maximum of 100 for the number of iterations required for convergence. That is, if the power vector does not converge in 100 iterations, we consider the network as an infeasible system.

Using an antenna array with four elements and our algorithm, we can increase the capacity of the network significantly. In Fig. 5(b) the total mobile power versus the number of users is depicted. Using omnidirectional antenna and power control algorithm with fixed base assignment, we can tolerate at most 660 users. In the same configuration, using the base station assignment and power control algorithm [11], we can increase the capacity to 800 users. If we use antenna array with four elements, using our algorithm, the network can tolerate 2800 users. Fig. 6 illustrates the base station assignments for the above three cases.

Fig. 5(b) shows that for a fixed number of users in our system, the total mobile power is an order of magnitude less than the other methods.

It has been observed in [11] that integration of both base station assignment and power control significantly increases the local capacity, i.e., handling more users when we have a hot-spot in the network. In order to demonstrate the effectiveness of our proposed approach, in Fig. 7, 400 users are dispersed randomly around the network. We then added users randomly in the local area of $[3.5, 4.5] \times [3.5, 4.5]$. When we add 22 users to the system with setup I, the traditional fixed base station assignment reaches its limit. Using the power allocation and base station assignment [11] and the same system setup, when we add 57 users we get overload. Using system setup II and our method, we can add 150 users prior to overload.

In summary, when we have the same configuration of users, the use of 4-element antenna arrays in the base stations and our algorithm significantly reduce the mobile power by almost an order of magnitude, which is very critical in terms of battery life in mobile sets. It also provides faster convergence compared to the existing power control algorithms. Furthermore, it can increase the capacity of systems significantly.

VII. Conclusion

We have introduced the consideration of joint optimal beamforming and power control. We provided an iterative algorithm amenable to distributed implementation which converges to the optimal beamforming and base station assignment if there exists at least one solution to the joint problem. An enhancement of the algorithm that makes it appropriate for joint power and base assignment as well as beamforming was considered as well.

For performance evaluation of our algorithm a notion of capacity was considered to be the maximum number of transmitters for which there exists a feasible power vector. It was shown that using antenna array at the base stations, the algorithm can improve the capacity

of networks significantly in terms of the number of users that can be supported. On the other hand, it speeds up the convergence and saves the total mobile powers, compared to the best known power control algorithms.

References

- [1] A. F. Naguib, A. Paulraj, and T. Kailath, "Capacity improvement with base-station antenna arrays in cellular CDMA," *IEEE Trans. Vehicular Technol.*, vol. 43, No. 3, Aug. 1994.
- [2] J. M. Aein, "Power balancing in system employing frequency reuse," *COMSAT Tech. Rev.*, vol. 3, Fall 1973.
- [3] R. W. Nettleton and H. Alavi, "Power control for spread spectrum cellular mobile radio system," in *Proc. IEEE Vehicular Technol. Conf., VTC-83*, 1983.
- [4] J. Zander, "Performance of optimum transmitter power control in cellular radio systems," *IEEE Trans. Vehicular Technol.*, vol. 41, pp. 57-62, February 1992.
- [5] S. Grandhi, R. Vijayan, D.J. Goodman, and J. Zander, "Centralized power control for cellular radio systems," *IEEE Trans. Vehicular Technol.*, vol. 42, Nov. 1993.
- [6] J. Zander, "Distributed cochannel interference control in cellular radio systems," *IEEE Trans. Vehicular Technol.*, vol. 41, Aug. 1992.
- [7] S. A. Grandhi, R. Vijayan, and D. J. Goodman, "A distributed algorithm for power control in cellular radio systems," in *Proc. 30th Allerton Conf. Commun. Control and Computing*, Moticello, IL. Sept. 1992.
- [8] G. J. Foschini, "A simple distributed autonomous power control algorithm and its convergence," *IEEE Trans. Vehicular Technol.*, vol. 42, No. 4, Nov. 1993.
- [9] D. Mitra, "An asynchronous distributed algorithm for power control in cellular radio systems," in *Fourth WIN-LAB Workshop on Third Generation Wireless Information Networks*, 1993.
- [10] R. Yates and C. Y. Huang, "Integrated power control and base station assignment," *IEEE Trans. Vehicular Technol.*, vol. 44, No. 3, Aug. 1995.
- [11] S. V. Hanly, "An algorithm for combined cell-site selection and power control to maximize cellular spread spectrum capacity," *IEEE J. Select. Areas Commun.*, Vol. 13, No. 7, Sept. 1995.
- [12] F. R. Gantmacher, "The Theory of Matrices," vol. 2, Chelsea, New York, 1990.
- [13] B. Suard, A. Naguib, G. Xu, and A. Paulraj, "Performance analysis of CDMA mobile communication systems using antenna array," in *Proc. ICASSP' 93*, vol. IV, Minneapolis, MN, pp. 153-156, April 1993.
- [14] S. S. Haykin, "Adaptive Filter Theory," *Prentice Hall, Inc.*, Englewood Cliffs, NJ, 1991.
- [15] G. Xu, Y. Cho, A. Paulraj, T. Kailath, "Maximum likelihood detection of co-channel communication signals via exploitation of spatial diversity," In *Proc. of the 26th Asilomar Conference on Signals, Systems, and Computers*, Pacific Grove, CA, Oct. 1992.

- [16] B. Ottersten, R. Roy, and T. Kailath, "Signal waveform estimation in sensor array processing," In *Proc. of the 23rd Asilomar Conference on Signals, Systems, and Computers*, Pacific Grove, CA, Nov. 1989.

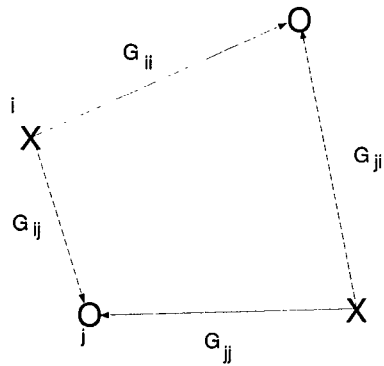

Fig. 1. A pair of cochannel links i and j is depicted.

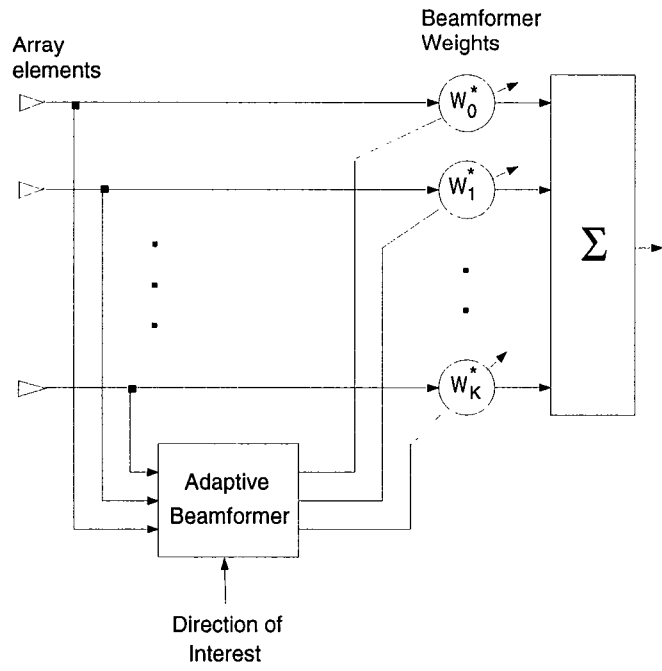

Fig. 2. Antenna array and beamformer.

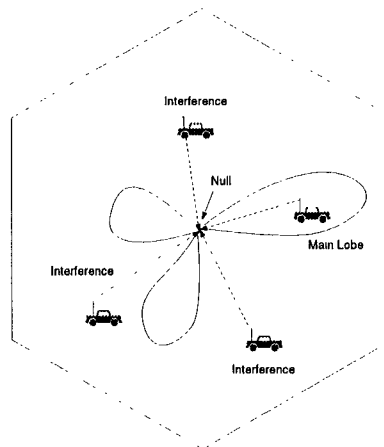

Fig. 3. Sample antenna array pattern

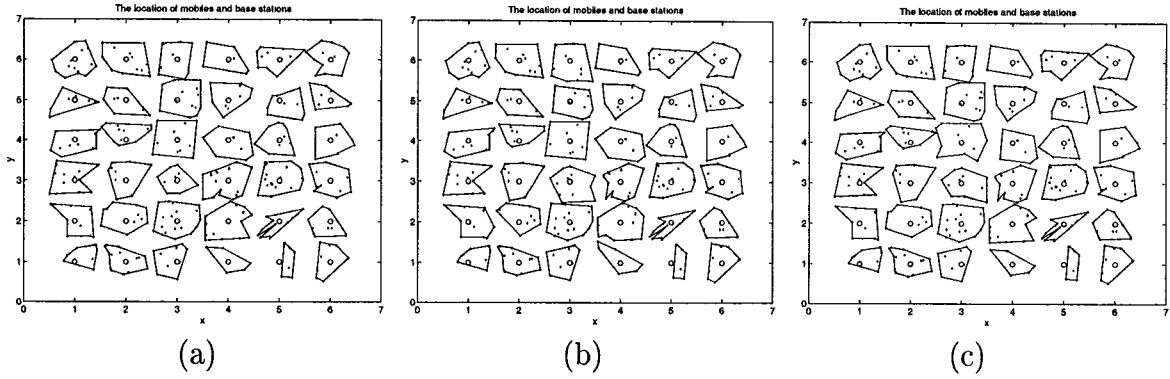

Fig. 4. Mobile and base stations locations for 400 users; (a) traditional assignment; (b) optimal base station and power control; (c) optimal base station, beamforming and power control.

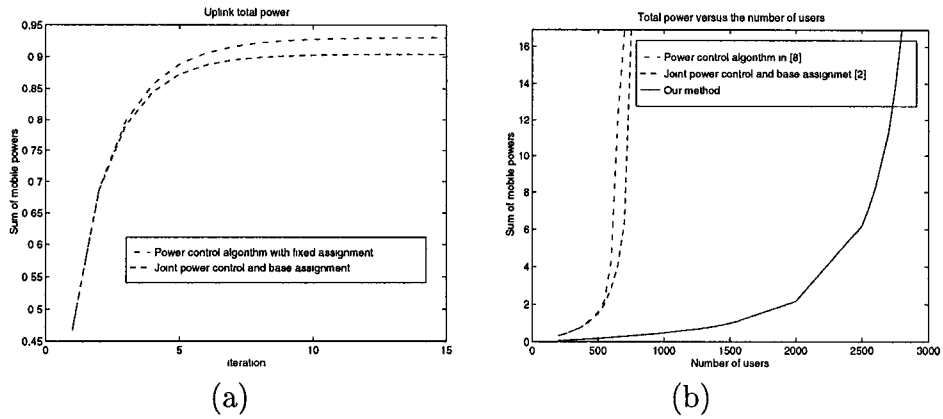

Fig. 5. (a) The total mobile powers versus the iteration number; (b) the total mobile powers versus the number of users.

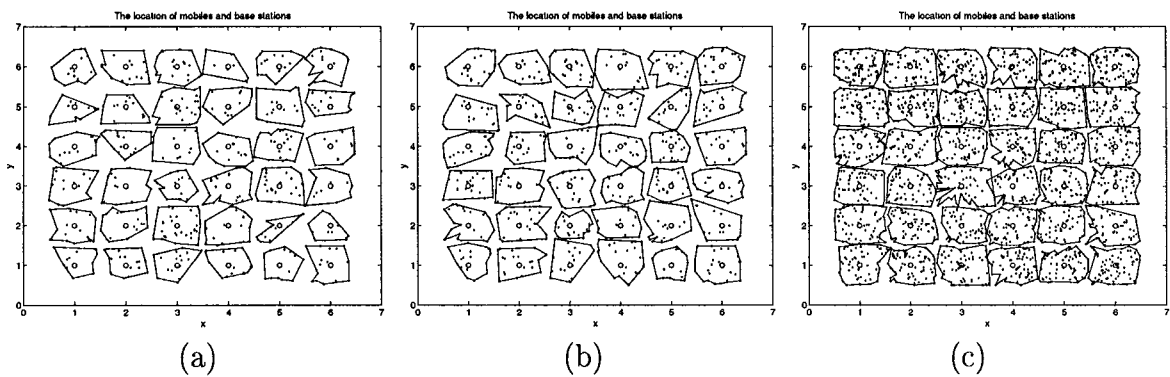

Fig. 6. Mobile and base stations locations; (a) traditional assignment with 660; (b) optimal base station and power control with 800; (c) optimal base station, beamforming and power control with 2800 users.

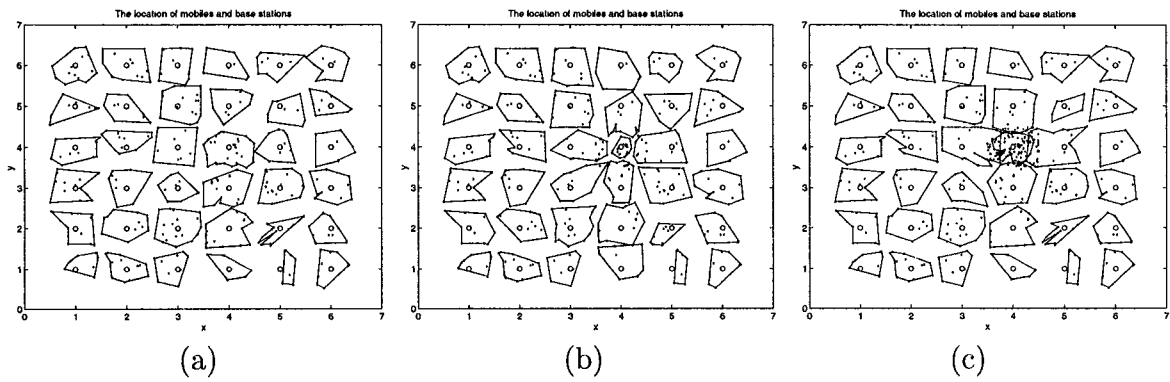

Fig. 7. Mobile and base stations locations with local congested area; (a) traditional assignment with 22 additional users; (b) optimal base station and power control with 57 additional users; (c) optimal base station, beamforming and power control with 150 additional users.

