

ABSTRACT

Title of dissertation: BIT OF NOSTALGIA... FOR ONE OR TWO
PERCUSSIONISTS AND LIVE ELECTRONICS
PERFORMER

Michael Boyd, Doctor of Musical Arts, 2006

Dissertation directed by: Professor Thomas DeLio
School of Music

Bit of nostalgia... is a work for one or two percussionists and a live electronics performer that explores performer creativity through a graphic score and investigates the ways that the objects performers interact with (instruments) shape their actions/performances. The percussionist(s) take an active role in designing the stage set-up for each performance by superimposing a grid on the performance space, and filling at least half of the sectors with combinations of instrument-types listed in the piece's instructions (including objects made of metal, wood, glass, paper, plastic, and stone). Each sector that contains groups of instruments also contains a music stand holding three of eighteen closely related score pages. The similarities inherent in the various score pages requires that performers frequently reinterpret quasi-redundant visual materials with greatly varying groups of instruments (and objects), emphasizing the differences between each instrument group.

While the performance proceeds, another performer interprets the same score using Cycling 74's MAX/MSP (software that accomplishes real-time sound synthesis and processing) to process and playback sound segments from recordings of previous rehearsals and/or performances. To accomplish this, the computer performer utilizes some or all of nine MAX/MSP patches (single windows containing a user designed graphical interface) of my design that incorporate differently controlled ring modulation, filtering, and delay in isolation or various combinations. The percussionists directly respond to these sounds as well as each other while interpreting certain pages of the score that contain the letters I, O, and T (signifying imitate, oppose, and transform respectively). These letters direct the performers to address sounds/actions produced by the other performer, themselves, or the electronics through their interpretations. Through these interactions, I hope to bring a sense of self-history into the piece and create an interesting notion of depth which reflects a broader perspective of what constitutes a "work." Whereas one typically thinks of an artwork as a fixed entity such as a score, I am trying to overtly link and interconnect otherwise marginalized and disparate aspects that contribute to the totality of this piece such as rehearsals and performances.

BIT OF NOSTALGIA... FOR ONE OR TWO PERCUSSIONISTS AND LIVE
ELECTRONICS PERFORMER

by

Michael Boyd

Dissertation submitted to the Faculty of the Graduate School of the
University of Maryland, College Park in partial fulfillment
of the requirements for the degree of
Doctor of Musical Arts
2006

Advisory Committee:

Professor Thomas DeLio, Chair
Professor Thomas Goldstein
Professor Richard King
Professor Merriam Rosen
Professor Mark Wilson

©Copyright by

Michael Boyd

2006

TABLE OF CONTENTS

| | |
|---|----|
| Performance Instructions | 1 |
| Performance Space Segmentation | 1 |
| Instrument configurations | 2 |
| Score Notation/Basic Performance Method | 3 |
| Timing | 3 |
| Duo versus Trio Versions | 4 |
| Electronics | 5 |
| Basic Interfaces | 6 |
| Accessing Sound Files | 7 |
| Recording | 9 |
| Ring Modulation | 10 |
| Single Filter | 12 |
| Single Delay | 14 |
| Multiple Filters | 16 |
| Multiple Delays | 18 |
| Filter-Delay Combination | 20 |
| Ring Modulation-Filter Combination | 22 |
| Ring Modulation-Delay Combination | 24 |
| Ring Modulation-Filter-Delay Combination | 26 |
| Performance Score | 28 |
| Appendix | 47 |

Performance Instructions

This piece is for one or two percussionists and a second/third performer manipulating live electronics.

Performance Space Segmentation

The performance space is conceptually divided into a number of equal-sized sectors – nine for a duo (single percussionist) performance (3x3, see Grid 1), and sixteen for a trio (4x4, see Grid 2). Each sector will either remain empty or contain a music stand and instrument(s); each music stand should hold one packet of three score pages (some performances may not use all score packets depending on how many sectors are filled). At least two, but no more than half of the sectors should be empty.

Grid 1 (duo)

| | | |
|--|--|--|
| | | |
| | | |
| | | |

Grid 2 (trio)

| | | | |
|--|--|--|--|
| | | | |
| | | | |
| | | | |
| | | | |

The remaining sectors (those not left empty) can be filled by using the list of instrument configurations provided (see the chart below); note that all non-empty sectors should be adjacent with at least one other non-empty sector (connection by corner is acceptable). The instrumental configurations are arranged into categories, and at least one configuration from each should be used in every performance. The configuration designations simply indicate the material that comprises the majority of each instrument (metal, wood, plastic, paper, stone, or glass); these instruments can be traditional percussion instruments, non-percussion instruments, or objects not typically associated with musical performance (some of each type should be used). The actual arrangement of instruments/objects in each sector is left to the performer's discretion, though the score should be visible when interacting with all instruments. The electronics performer should be positioned with on the periphery of or just beyond the performance space with a computer, mixer, and so forth. Two speakers should be interspersed in the space at the performers' discretion.

Instrument configurations

| Category 1 | Category 2 | Category 3 | Category 4 | Category 5 |
|--------------------------------------|-------------------|-------------------|--------------------|--------------------------------|
| Music stand alone (no other objects) | Multiple metal | 1 wood | 1 glass, 1 stone | Multiple metal, plastic, paper |
| | Multiple plastic | 1 paper | 1 wood, 1 paper | Multiple stone, wood, plastic |
| | Multiple glass | 1 stone | 1 metal, 1 glass | Multiple paper, glass, plastic |
| | Multiple paper | 1 metal | 1 plastic, 1 stone | Multiple metal, stone, glass |

Sample Performance Space Arrangement (duo)

| | | |
|------------------------------------|---|--|
| 1 metal (ex: vibraphone) | 1 glass, 1 stone (ex: water glass, large stone) | 1 metal, 1 plastic (ex: brake drum, plastic drop cloth) |
| (empty) | Music stand alone | (empty) |
| Multiple paper (ex: several books) | (empty) | Multiple paper, glass, plastic (ex: ream of paper, glass chimes, plastic “granite” blocks, etc.) |

Score Notation/Basic Performance Method

The score contains a variety of graphic images that are interpreted by the performer(s); these interpretations should not only account for the types of graphics used, but also how they relate to each other (their arrangement on the page). The graphics are not specific with regard to performance output. Over the course of the piece, players should attempt to express each the “essence” of each graphic image through varied interpretations of each, though repetition may be utilized as part of specific interpretations. Performers should not limit themselves to traditional performance practice; graphics might suggest sounds, visual gestures, or other actions. In sectors that contain instruments, the performer(s) should attempt to incorporate all instruments in their interpretation, though if a sector contains only a music stand, the performer(s) should use their body, voice, music stand, and/or any performance space features that are present in that sector. *Player(s) are encouraged to be creative and explore!* Some pages contain transformation indicators that appear as three different gray letters: I, T, and/or O (standing for “imitate,” “transform,” and “oppose” respectively). These indicate how one should react to external stimuli such as present or past actions and/or sounds presented by the other player, yourself, and/or the electronics. The placement of these letters with respect to the score graphics should become part of one’s interpretation. Each score page has a numeric and alphabetic label in the upper left corner that will be addressed shortly.

Timing

The timing of each interpretation is determined by individual performers. This typically, though not always, spans the amount of time necessary to articulate the essential character of each page. In some cases, it may be desirable to focus one’s

interpretation on a single aspect of the score, and gradually integrate other aspects, with the interpretation of the total page as a goal; other times one may choose to interpret the whole page at once; other temporal possibilities for interpretations exist (shifting focus for example). Once a page interpretation has been completed, that performer must travel to an adjacent sector containing a music stand. Upon reaching the new music stand, the performer must choose a score page that shares either a number or letter label with the previously performed page. For example, if one has just finished a page labeled “3A,” the next page to be performed should have a “3” or an “A” (or both) as part of its label. Two performers may not occupy the same sector simultaneously. The total length of the performance is left to the discretion of the performers.

Duo versus Trio Versions

The duo and trio versions use the same score packets (groups of three pages), and performance instructions outlined above. As discussed in the “Performance Space Segmentation” section, the two versions differ in the type of grid used, and therefore the possible number of full/empty sectors. Additionally, the duo/trio performances will offer different stimuli for the performer(s) to respond to when addressing the transformation indicators (I, T, O) in the score. In the duo version, the performer must address either his/her previous actions/sounds and/or the sounds presented by the electronics; in the trio, the performers also can respond actions/sounds created by each other.

Electronics

The electronics performer will use MAX/MSP, a software package with a graphical interface that facilitates real-time synthesis and processing. Nine MAX/MSP patches (discrete panels designed by the user/composer to enable specific synthesis and/or processing tasks) and a copy of MAX/MSP Runtime 4.5 (a freeware program that allows one to perform with but not edit MAX/MSP patches) are included on a CD-ROM that is provided with this piece's performance materials. Each patch is designed to allow the performer to manipulate one or more predetermined sound files (see below) in various ways during a performance. The electronics performer should use one patch at a time (a tenth patch is provided that facilitates recording; this patch may be used throughout entire rehearsals and performances while another patch is in use).

Each patch should be treated in the same way as the percussionist(s) treat each sector of the performance space. Individual patches are associated with a packet of three score pages, and the manipulation of a patch (described below) should result from the electronics operator's interpretation of a single score page. For example, when faced with a patch featuring a single band-pass filter and a score page containing a large oscillating line and a small stream of numbers, the electronics operator might manually oscillate the total volume output of the signal while randomizing the central frequency of the filter. The movement from one patch to the next should imitate the percussionist(s) movement between sectors in timing and choice of score pages. The electronics performer determines the length of use of a particular patch based on his/her interpretation of the given score page; upon accessing a new patch, the associated score page should be chosen to match either the number or letter designation of the previously used page. The electronics operator does not use score pages with transformation indicators (I, T, O), though the percussionist(s) can (and should) respond to the sounds produced by the electronics when addressing this facet of their score.

Rehearsals and performances should be recorded whenever possible (using the tenth patch that facilitates recording, or any other means); these recordings will serve as the source material for live processing by the electronics operator. The rehearsal/performance recordings may be shortened or volume-adjusted in any editing program prior to their usage in MAX/MSP.

Each patch requires a significant amount of customization (resulting from the operator's interpretation of the score) prior to the execution (sound playback) of that patch, as well as potentially during playback. For example, one might configure a random number generator, breakpoint file, and/or use a graphic slider to tailor the processes applied to the sound file(s) including filtering, delay, and ring modulation. The process of configuring each patch will take a small amount of time; this punctuation between electronics entrances is desirable and encouraged. All patches are explained below, and ample labels are present within each patch explaining what modes of interaction are available.

Basic Interfaces

There are a few interfaces that are used throughout this and many other pieces that utilize MAX/MSP. These will be addressed prior to explaining individual patches.

 **Toggle** – This box activates/deactivates an object that it is connected to (it might for example start a random number generator or play a sound file). Clicking a toggle once turns it on and makes an X appear in the box; clicking a second time turns it off and removes the X.

 **Button** – A button functions similarly to a toggle, except that it simply initiates a process when clicked, and cannot be turned off. In this work, buttons are used only to begin finite processes such as breakpoint functions.

 **Number box** – Number boxes are used in two ways in this piece. Primarily, they are used to provide the electronics performer with the numerical output of various objects or processes such as random number generators, sliders, breakpoint functions, and so forth. However, one can also type a numerical value into a number box (if the box contains a decimal point, it is considered a “float number box” and will accept non-integers; if the box does not contain a decimal point it is an “int number box” and will only accept integers). Hitting the enter key after entering a value in a number box will send that value to any object to which it is connected.



Message boxes – Message boxes (boxes which can contain text or numbers) are used throughout this piece’s MAX/MSP patches. Clicking on a message box sends its data to any object to which it is connected. The message boxes pictured to the left are frequently used in this piece’s patches to select sound files and output channels (in these cases, ample labels are provided to indicate what each message box selects). The boxes containing “clear,” “open,” “pause,” “resume,” and other messages will be discussed shortly.

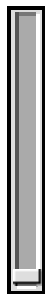

Slider – Sliders are manually controlled objects that output a range of numbers; they can be manipulated prior to the initiation of sound, or in real-time during playback. Clicking on the slider and dragging will smoothly transition between numerical values while clicking anywhere on the object with the mouse will immediately move the slider to that position.



Breakpoint function editor – Breakpoint function editors allow one to design the trajectory of a specific process over a given span of time (x axis = time; y axis = numerical values at each point in time). Clicking within these boxes will add points that are connected linearly; points can be moved by clicking on them and dragging. The “clear” message box that appears above each breakpoint function editor will clear all points. The range of each breakpoint function is predetermined depending on what process/facet is being designed. The domain (total time) is user determined. In this piece, all breakpoint functions within a single patch are temporally coordinated, so a single number box exists in each patch where one can enter (type) the domain for all breakpoints in seconds to three decimal points. Note that typing the domain and hitting the enter key will initiate all breakpoint functions; if this is not desired, simply type the domain value without hitting the enter key. Changing the breakpoint domain will not affect the shapes present in the breakpoint function editors, they will simply be output at different speeds. Adjacent to the number box that determines the breakpoint function domains is a button which will initiate all breakpoint functions (similar to hitting the enter key after entering the breakpoint domain); this causes the breakpoint functions to smoothly output all of the Y-axis values over the specified time.

Accessing Sound Files

All nine patches allow sound file processing and access these files in the same way. Learning how to open and use these files in one patch will allow you to do the same in all others.

- The “open” message box allows you to select the file that you wish to manipulate. Clicking on it facilitates navigation through the computer, similar to most other applications.
- To initiate playback from the beginning of the file, click the toggle on at the far left. Clicking it again will stop the file’s playback.
- The “pause” and “resume” message boxes are fairly intuitive; the former pauses playback and the latter resumes playback from the point where the file was paused.
- The number box located at the far right allows access to any point within a sound file. Simply click on the box, type the point in seconds (up to three decimal places) where you want the sound file to begin playback, and hit enter; the file will begin playback from the specified point.
- To change the selected sound file at any point, click open and locate a new file. To initiate its playback, it is necessary to deactivate and reactivate the toggle (click to remove the X, and then click again to reactivate).



Methods of Data Manipulation

This piece uses six methods for manipulating data that directly affect sonic output. Each will be discussed at length here and referenced briefly throughout the remaining instructions. Note that number boxes are adjacent to all data manipulations to provide the performer with output information.

- **Manual sliders** – Sliders are used frequently to directly manipulate data (such as volume, delay time, and so forth). These function exactly as described previously.
- **Breakpoint functions** – Breakpoint functions work as described above, and allow the user to determine the trajectory of a single piece of data (such as volume, delay time, and so forth). These functions are of finite length specified in a number box. Y-axis values at the beginning and end of each breakpoint function will automatically be inserted upon initiation of the function to ensure smooth playback and manipulation.
- **Random number generators (4)** – Random number generators are utilized in four different formats. A toggle labeled “Initiate random number generation” is present in all files, and globally starts and stops all random number generators. Since random number generation is a perpetual process (whose data can be used selectively through other means), it is advisable to initiate generation while preparing a patch and let the process continue throughout the use of that patch.
 - **Random/regular/smooth** – This format generates numbers at a regular interval specified by a slider, and smoothly transitions (glisses) from one value to the next. A number box adjacent to the slider indicates how often numbers will be generated, and a number box below the slider displays the random number generator’s output.
 - **Random/regular/abrupt** – This format generates numbers at a regular interval specified by a slider, and discretely transitions from one value to the next (this sometimes results in subtle clicking). A number box adjacent to the slider indicates how often numbers will be generated, and a number box below the slider displays the random number generator’s output.
 - **Random/random/smooth** – This format generates numbers at random intervals, and smoothly transitions (glisses) from one value to the next. A number box below the slider displays the random number generator’s output.
 - **Random/random/abrupt** – This format generates numbers at random intervals, and discretely transitions from one value to the next (this sometimes results in subtle clicking). A number box below the slider displays the random number generator’s output.

Recording

The file “Record.pat” can be used to record rehearsals and performances (any alternate method for accomplishing this task is also acceptable). This patch contains three interactive aspects, two toggles and an “open” message box.

- First click the uppermost toggle, initiating the program’s analog to digital converter which imports sound from the computer’s soundcard (some customized configuration may be necessary to route microphone input through the computer’s soundcard).
- Next, click the “open” message box. This will allow you to select a filename, destination, and file format (wav and aif are most common, the former for PC and the latter for Mac platforms) for the recorded sounds.
- Finally, click the lower toggle to initiate recording. When finished, click this toggle again to stop recording; the recording will be located and named as specified via the “open” message box.

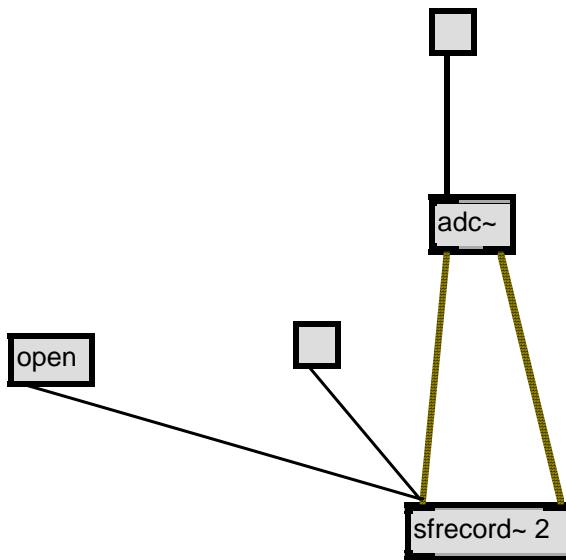

Ring Modulation

The file “Ring.pat” features ring modulation processing. The user can modulate one sound file against another, or against an oscillator whose frequency can be manipulated.

- Begin by opening Sound files 1-4 using the interface located in the lower left section of the screen.
- Using the message boxes containing numbers, select the initial original and modulating signals (these can be changed during performance). Selecting the “None” message box for one of these signals will result in the unaltered playback of the other signal. Selecting “None” for both signals will result in no sound output.
- If using the oscillator as the modulating signal, the right side of the screen provides methods for manipulating its frequency. Click the numbered message box that corresponds to the initial manipulation you wish to use (the manipulation processes are described previously in the “Methods of Data Manipulation” section). Make any necessary preparations to the sliders and breakpoint function editor, and initiate random number generation.
- Adjust the original signal volume, modulating signal volume, and total volume sliders; it is important to note that volume output is greater for non-modulated and oscillator-modulated sound files than when two sound files are modulated.
- Use the toggle in the upper left corner of the screen to turn audio output on.
- Use the sound file toggles to begin sound file playback (one can either start individual files or all).
- Once all of this has been accomplished, one can switch between signals, open and start new sound files, adjust how the oscillator frequency is manipulated, and adjust the volume of each signal and sound output.

Turn audio on and off (x = on)

Total volume Orig. sig. vol. Mod. sig. vol.

- Choose the original signal
- 1 Soundfile 1
 - 2 Soundfile 2
 - 3 None
- Choose the modulating signal
- 1 Soundfile 3
 - 2 Soundfile 4
 - 3 Oscillator
 - 4 None

- Choose how to manipulate oscillator frequency
- 1 Breakpoint
 - 2 Manual slider
 - 3 Random/ regular/smooth
 - 4 Random/ regular/abrupt
 - 5 Random/ random/smooth
 - 6 Random/ random/abrupt

- Initiate breakpoint execution
- Determine total length for breakpoint file
- Initiate random number generation

Start all soundfiles

Soundfile 1

open pause resume

Soundfile 2

open pause resume

Soundfile 3

open pause resume

Soundfile 4

open pause resume

clear

0. 1 - breakpoint

2 - slidr

0. output

3 - adjusts rand. # gen. rate

0. rate (sec) output

4 - adjusts rand. # gen. rate

0. rate (sec) output

5 - output

6 - output

Ring.pat

Single Filter

The file “Single Filter.pat” features processing by a single band-pass filter. The user can manipulate volume, center frequency, and bandwidth (Q-factor).

- Begin by opening Sound files 1 and 2 using the interface located in the upper left section of the screen. Use the message boxes below “Sound file 1” to select which file to filter initially.
- Use the message boxes containing the numbers 1 through 6 in the middle of the screen to initially determine how to manipulate the filter’s volume, center frequency, and bandwidth (the manipulation processes are described previously in the “Methods of Data Manipulation” section).
- Make any necessary preparations to the sliders and breakpoint function editor, and initiate random number generation.
- Use the toggle in the upper middle of the screen to turn audio output on.
- Use the sound file toggles to begin playback.
- Once all of this has been accomplished, one can switch between sound files, open and start new sound files, and adjust how the volume, center frequency, and bandwidth are manipulated.

Soundfile 1

open pause resume

Soundfile 2

open pause resume

Initiate breakpoint execution(s)

Determine total length for all breakpoint files

Initiate random number generation

Turn audio output on and off (x = on)

Choose the soundfile to be played back and processed

None

Soundfile 1

Soundfile 2

Choose how to manipulate volume

Breakpoint

Manual slider

Random/ regular/smooth

Random/ regular/abrupt

Random/ random/smooth

Random/ random/abrupt

Choose how to manipulate center frequency

Breakpoint

Manual slider

Random/ regular/smooth

Random/ regular/abrupt

Random/ random/smooth

Random/ random/abrupt

Choose how to manipulate bandwidth

Breakpoint

Manual slider

Random/ regular/smooth

Random/ regular/abrupt

Random/ random/smooth

Random/ random/abrupt

clear

clear

clear

1 - breakpoint

2 - sldr

3 - adjusts rand. # gen. rate

4 - adjusts rand. # gen. rate

5 - output

6 - output

output

output

output

1 - breakpoint

2 - sldr

3 - adjusts rand. # gen. rate

4 - adjusts rand. # gen. rate

5 - output

6 - output

output

output

output

1 - breakpoint

2 - sldr

3 - adjusts rand. # gen. rate

4 - adjusts rand. # gen. rate

5 - output

6 - output

output

output

output

Single filter.pat

Single Delay

The file “Single Delay.pat” features delay and feedback processing. The user can manipulate the volume of the un-delayed and delayed sound files (the former is heard in the left channel, the latter in the right), delay time, and feedback strength.

- Begin by opening Sound files 1 and 2 using the interface located in the upper left section of the screen. Use the message boxes below “Sound file 1” to select which file to delay initially.
- Use the message boxes containing the numbers 1 through 6 in the middle of the screen to initially determine how to manipulate the delayed and un-delayed volume, delay time, and feedback strength (the manipulation processes are described previously in the “Methods of Data Manipulation” section).
- Make any necessary preparations to the sliders and breakpoint function editor, and initiate random number generation.
- Use the toggle in the upper middle of the screen to turn audio output on.
- Use the sound file toggles to begin sound file playback.
- Once all of this has been accomplished, one can switch between sound files, open and start new sound files, and adjust how the volume, delay time, and feedback strength are manipulated.

Soundfile 1

open pause resume

Soundfile 2

open pause resume

Initiate breakpoint execution(s)

Determine total length for all breakpoint files

Initiate random number generation

Turn audio output on and off (x = on)

Choose the soundfile to be played back and processed

0 None

1 Soundfile 1

2 Soundfile 2

Choose how to manipulate the volume of the unprocessed soundfile

1 Breakpoint

2 Manual slider

3 Random/ regular/smooth

4 Random/ regular/abrupt

5 Random/ random/smooth

6 Random/ random/abrupt

clear

1 - breakpoint

2 - sldr

3 - adjusts rand. # gen. rate

4 - adjusts rand. # gen. rate

5 - output

6 - output

output

output

Choose how to manipulate the volume of the delayed soundfile

1 Breakpoint

2 Manual slider

3 Random/ regular/smooth

4 Random/ regular/abrupt

5 Random/ random/smooth

6 Random/ random/abrupt

clear

1 - breakpoint

2 - sldr

3 - adjusts rand. # gen. rate

4 - adjusts rand. # gen. rate

5 - output

6 - output

output

output

Choose how to manipulate the delay time

1 Breakpoint

2 Manual slider

3 Random/ regular/smooth

4 Random/ regular/abrupt

5 Random/ random/smooth

6 Random/ random/abrupt

clear

1 - breakpoint

2 - sldr

3 - adjusts rand. # gen. rate

4 - adjusts rand. # gen. rate

5 - output

6 - output

output

output

Choose how to manipulate the feedback strength

1 Breakpoint

2 Manual slider

3 Random/ regular/smooth

4 Random/ regular/abrupt

5 Random/ random/smooth

6 Random/ random/abrupt

clear

1 - breakpoint

2 - sldr

3 - adjusts rand. # gen. rate

4 - adjusts rand. # gen. rate

5 - output

6 - output

output

output

Single Delay.pat

Multiple Filters

The file “Multiple Filters.pat” features processing of one to six sound files by up to six band-pass filters. The user can manipulate volume, center frequency, and the bandwidth (Q-factor) for each filter.

- Begin by opening Sound files 1 through 7 using the interface located on the left section of the screen.
- The six filters are labeled. Use the message boxes containing the numbers 0 through 7 to select which file each filter will process (selecting 0 will negate the use of that filter). Note that it is possible to filter a single sound file six different ways, or to filter six sound files simultaneously..
- Using the message boxes containing the numbers 0, 1, and 2 to select which channel each filter will initially output to (1 = left, 2 = right).
- Make any necessary preparations to the sliders and breakpoint function editors, and initiate random number generation (note that each filter uses the same type of manipulation for all three of its variables; the manipulation processes are described previously in the “Methods of Data Manipulation” section).
- Use the toggle in the upper left of the screen to turn audio output on.
- Use the sound file toggles to begin playback.
- Once all of this has been accomplished, one can switch between sound files, filters, and output channels, open and start new sound files, and adjust how the volume, center frequency, and bandwidth are manipulated.

Initiate breakpoint execution(s)
 Determine total length for all breakpoint files
 Initiate random number generation
 Turn audio output on and off (x = on)
 Start/stop all soundfiles

Soundfile 1
 open pause resume

Soundfile 2
 open pause resume

Soundfile 3
 open pause resume

Soundfile 4
 open pause resume

Soundfile 5
 open pause resume

Soundfile 6
 open pause resume

Soundfile 7
 open pause resume

Determine max output, channel 1 (left)

Determine max output, channel 2 (right)

Filter 1 - Manual manipulation
 Choose a soundfile

Choose an output channel

Volume Ctr. freq. Bandwidth

Filter 2 - Random/regular/smooth
 Choose a soundfile

Choose an output channel

Adjusts rand. # gen. rate, volume rate (sec)
 Adjusts rand. # gen. rate, ctr. freq. rate (sec)

Filter 3 - Random/regular/abrupt
 Choose a soundfile

Choose an output channel

Adjusts rand. # gen. rate, bandwidth rate (sec)

Adjusts rand. # gen. rate, volume rate (sec)
 Adjusts rand. # gen. rate, ctr. freq. rate (sec)
 Adjusts rand. # gen. rate, bandwidth rate (sec)

Filter 4 - Random/random/smooth
 Choose a soundfile

Choose an output channel

output
 vol.
 delay
 fdbk.

Filter 6 - Breakpoint
 Choose a soundfile

Choose an output channel

Volume Center frequency Bandwidth

Filter 5 - Random/random/abrupt
 Choose a soundfile

Choose an output channel

output
 vol.
 delay
 fdbk.

Multiple Filters.pat

Multiple Delays

The file “Multiple Delays.pat” features processing of one to six sound files by up to six delays. The user can manipulate volume, delay time, and feedback strength for each delay.

- Begin by opening Sound files 1 through 7 using the interface located on the left section of the screen.
- The six delays are labeled. Use the message boxes containing the numbers 0 through 7 to select which file each filter will process (selecting 0 will negate the use of that delay). Note that it is possible to delay a single sound file six different ways, or to delay six sound files simultaneously.
- Using the message boxes containing the numbers 0, 1, and 2 to select which channel each delay will initially output to (1 = left, 2 = right).
- Make any necessary preparations to the sliders and breakpoint function editors, and initiate random number generation (note that each delay uses the same type of manipulation for all three of its variables; the manipulation processes are described previously in the “Methods of Data Manipulation” section).
- Use the toggle in the upper left of the screen to turn audio output on.
- Use the sound file toggles to begin playback.
- Once all of this has been accomplished, one can switch between sound files, delays, and output channels, open and start new sound files, and adjust how the volume, delay time, and feedback strength are manipulated.

Initiate breakpoint execution(s)
 Determine total length for all breakpoint files
 Initiate random number generation
 Turn audio output on and off (x = on)
 Start/stop all soundfiles
 Soundfile 1
 open pause resume
 Soundfile 2
 open pause resume
 Soundfile 3
 open pause resume
 Soundfile 4
 open pause resume
 Soundfile 5
 open pause resume
 Soundfile 6
 open pause resume
 Soundfile 7
 open pause resume

Determine max output, channel 1 (left)

 Determine max output, channel 2 (right)

Delay 1 - Manual manipulation
 Choose a soundfile

 Choose an output channel

 Volume
 Delay time
 Feedback

Delay 2 - Random/regular/smooth
 Choose a soundfile

 Choose an output channel

 Adjusts rand. # gen. rate, volume
 rate (sec)
 output

Adjusts rand. # gen. rate, delay
 rate (sec)
 output

Adjusts rand. # gen. rate, feedback
 rate (sec)
 output

Adjusts rand. # gen. rate, volume
 rate (sec)
 output

Adjusts rand. # gen. rate, delay
 rate (sec)
 output

Adjusts rand. # gen. rate, feedback
 rate (sec)
 output

Delay 4 - Random/random/smooth
 Choose a soundfile

 Choose an output channel

 output
 vol.
 delay
 fdbk.

Delay 6 - Breakpoint
 Choose a soundfile

 Choose an output channel

 Volume clear
 Delay clear
 Feedback clear

output

output

output

Multiple Delays.pat

Filter-Delay Combination

The file “Filter-Delay.pat” features processing of one sound file by a band-pass filter and delay. The user can manipulate volume, center frequency, bandwidth, delay time, and feedback strength.

- Begin by opening Sound files 1 and 2 using the interface located in the upper left section of the screen. Use the message boxes below “Sound file 1” to select which file to delay initially.
- Use the message boxes containing the numbers 1 through 6 in the middle and bottom of the screen to initially determine how to manipulate the filtered/un-delayed and filtered/delayed volumes (spatialization is similar to the Single Delay patch), delay time, and feedback strength Use the message boxes containing the numbers 1 through 6 in the middle of the screen to initially determine how to manipulate the delayed and un-delayed volume, delay time, and feedback strength (the manipulation processes are described previously in the “Methods of Data Manipulation” section).
- Make any necessary preparations to the sliders and breakpoint function editors, and initiate random number generation.
- Use the toggle in the upper middle of the screen to turn audio output on.
- Use the sound file toggles to begin sound file playback.
- Once all of this has been accomplished, one can switch between sound files, open and start new sound files, and adjust how the volume, center frequency, bandwidth, delay time, and feedback strength are manipulated.

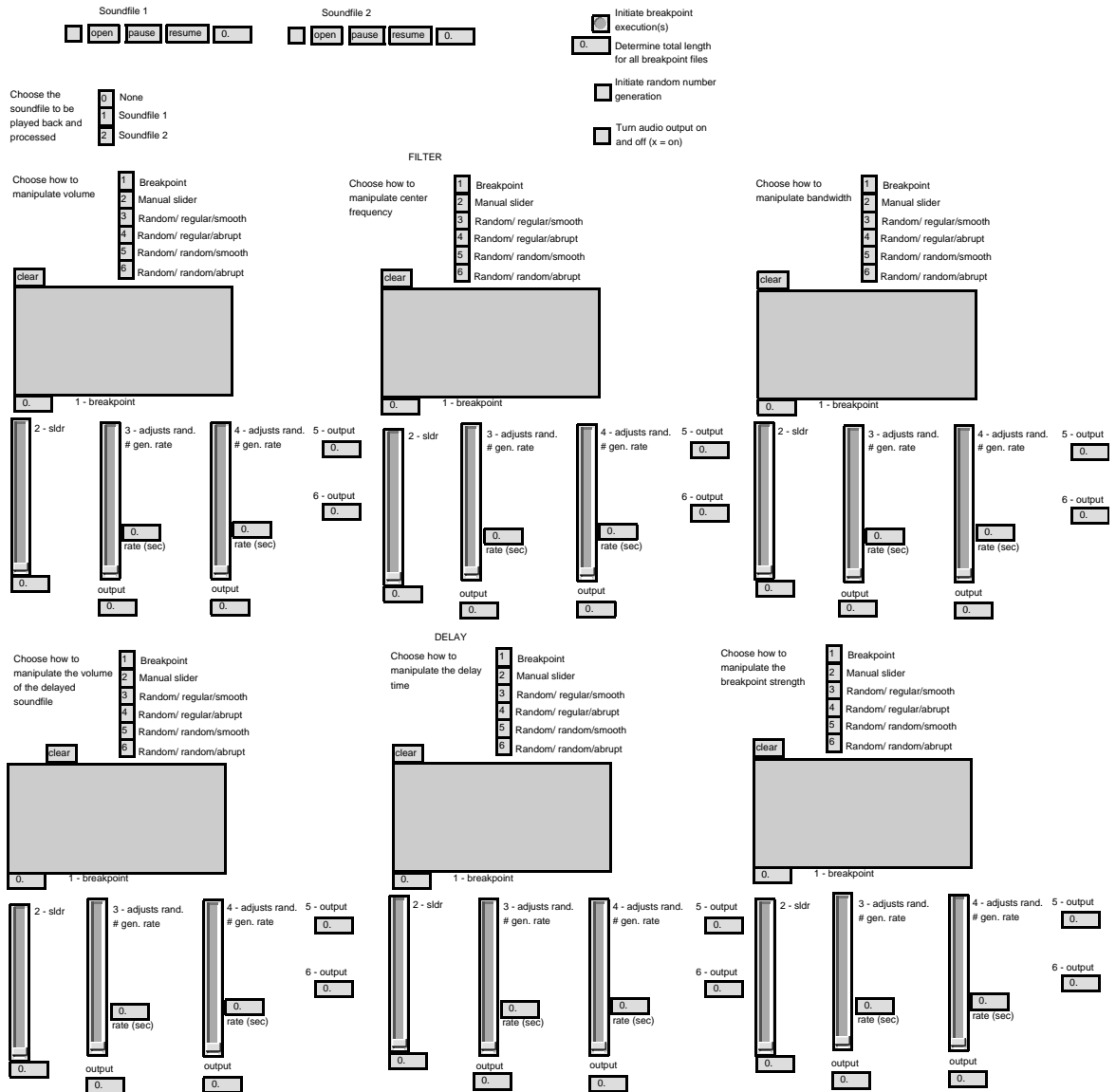

Filter-Delay.pat

Ring Modulation-Filter Combination

The file “Ring-Filter.pat” features ring modulation and band-pass filter processing. The user can modulate one sound file against another, or against an oscillator whose frequency can be controlled using several methods while manipulating the filter’s volume, center frequency, and bandwidth (Q-factor).

- Begin by opening Sound files 1-4 using the interface located in the lower left section of the screen.
- Using the message boxes containing numbers, select the initial original and modulating signals (these can be changed during performance). Selecting the “None” message box for one of these signals will result in the unaltered playback of the other signal. Selecting “None” for both signals will result in no sound output.
- If using the oscillator as the modulating signal, click the numbered message box that corresponds to the initial frequency manipulation you wish to use (the manipulation processes are described previously in the “Methods of Data Manipulation” section). Make any necessary preparations to the “Ring Modulation” sliders and breakpoint function editor, and initiate random number generation.
- Adjust original and modulating signal volumes; it is important to note that volume output is greater for non-modulated and oscillator-modulated sound files than when two sound files are modulated.
- In the “Filter” portion of the screen, use the message boxes containing the numbers 0, 1, and 2 to select which channel each filter will initially output to (1 = left, 2 = right).
- Make any necessary preparations to the “Filter” sliders and breakpoint function editors, and, if not previously completed, initiate random number generation (note that each filter uses the same type of manipulation for all three of its variables; the manipulation processes are described previously in the “Methods of Data Manipulation” section).
- Use the toggle in the upper middle of the screen to turn audio output on.
- Use the “Determine max output” sliders in the middle of the screen to set initial volume levels for each channel (1 is normal).
- Use the sound file toggles to begin sound file playback (one can either start individual files or all).
- Once all of this has been accomplished, one can switch between signals, open and start new sound files, adjust how the oscillator frequency is manipulated, adjust the volume of each signal and sound output, switch between filters and output channels, and adjust how the filter volume, center frequency, and bandwidth are manipulated.

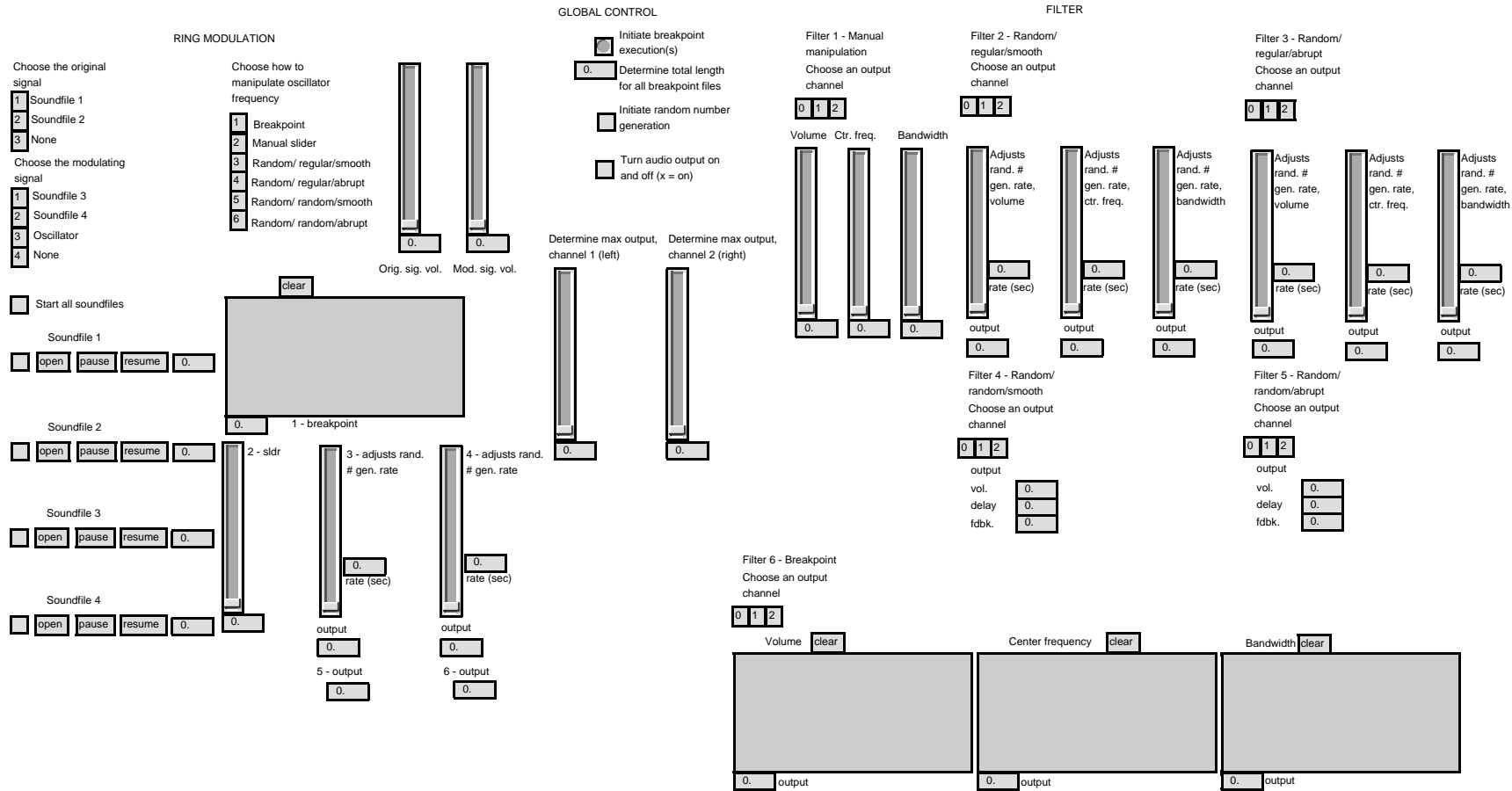

Ring-Filter.pat

Ring Modulation-Delay Combination

The file “Ring-Delay.pat” features ring modulation and delay processing. The user can modulate one sound file against another, or against an oscillator whose frequency can be controlled using several methods while manipulating volume, delay time, and feedback strength.

- Begin by opening Sound files 1-4 using the interface located in the lower left section of the screen.
- Using the message boxes containing numbers, select the initial original and modulating signals (these can be changed during performance). Selecting the “None” message box for one of these signals will result in the unaltered playback of the other signal. Selecting “None” for both signals will result in no sound output.
- If using the oscillator as the modulating signal, click the numbered message box that corresponds to the initial frequency manipulation you wish to use (the manipulation processes are described previously in the “Methods of Data Manipulation” section). Make any necessary preparations to the “Ring Modulation” sliders and breakpoint function editor, and initiate random number generation.
- Adjust original and modulating signal volumes; it is important to note that volume output is greater for non-modulated and oscillator-modulated sound files than when two sound files are modulated.
- In the “Delay” portion of the screen, use the message boxes containing the numbers 0, 1, and 2 to select which channel each filter will initially output to (1 = left, 2 = right).
- Make any necessary preparations to the “Delay” sliders and breakpoint function editors, and, if not previously completed, initiate random number generation (note that each delay uses the same type of manipulation for all three of its variables; the manipulation processes are described previously in the “Methods of Data Manipulation” section).
- Use the toggle in the upper middle of the screen to turn audio output on.
- Use the “Determine max output” sliders in the middle of the screen to set initial volume levels for each channel (1 is normal).
- Use the sound file toggles to begin sound file playback (one can either start individual files or all).
- Once all of this has been accomplished, one can switch between signals, open and start new sound files, adjust how the oscillator frequency is manipulated, adjust the volume of each signal and sound output, switch between delays and output channels, and adjust how the volume, delay time, and feedback strength are manipulated.

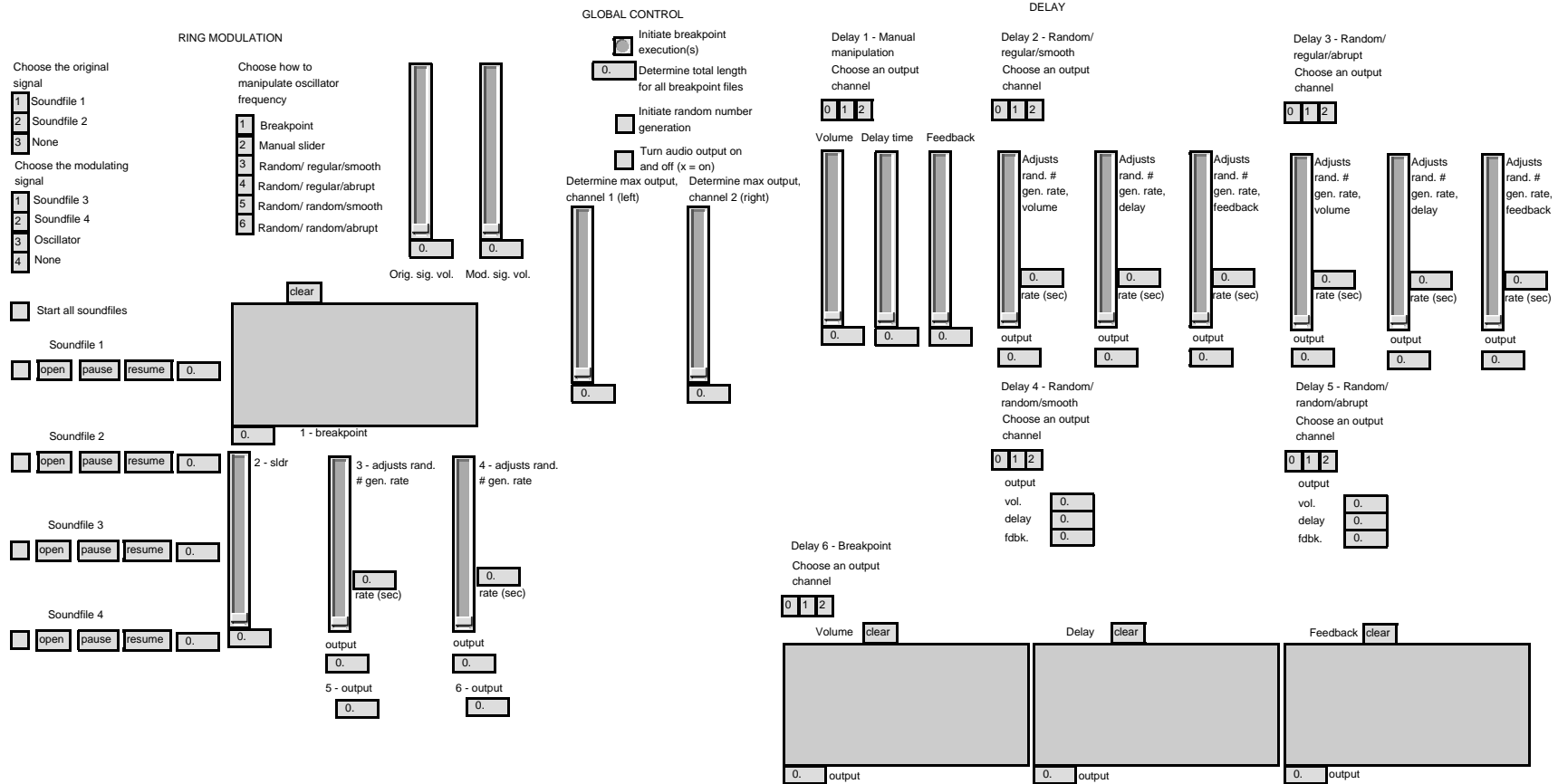

Ring-Delay.pat

Ring Modulation-Filter-Delay Combination

The file “Ring-Delay.pat” features ring modulation, band-pass filter, and delay processing. The user can modulate one sound file against another, or against an oscillator whose frequency can be controlled using several methods while manipulating volume, center frequency, bandwidth (Q-factor), delay time, and feedback strength.

- Begin by opening Sound files 1-4 using the interface located in the lower left section of the screen.
- Using the message boxes containing numbers, select the initial original and modulating signals (these can be changed during performance). Selecting the “None” message box for one of these signals will result in the unaltered playback of the other signal. Selecting “None” for both signals will result in no sound output.
- If using the oscillator as the modulating signal, click the numbered message box that corresponds to the initial frequency manipulation you wish to use (the manipulation processes are described previously in the “Methods of Data Manipulation” section). Make any necessary preparations to the “Ring Modulation” sliders and breakpoint function editor, and initiate random number generation.
- Adjust original and modulating signal volumes; it is important to note that volume output is greater for non-modulated and oscillator-modulated sound files than when two sound files are modulated.
- Use the message boxes containing the numbers 1 through 6 in the middle and bottom of the screen to initially determine how to manipulate the delayed and un-delayed volumes, center frequency, bandwidth, delay time, and feedback strength (the manipulation processes are described previously in the “Methods of Data Manipulation” section).
- Make any necessary preparations to the “Filter” and “Delay” sliders and breakpoint function editors, and, if not previously completed, initiate random number generation (note that each delay uses the same type of manipulation for all three of its variables).
- Use the toggle in the upper middle of the screen to turn audio output on.
- Use the sound file toggles to begin sound file playback (one can either start individual files or all).
- Once all of this has been accomplished, one can switch between signals, open and start new sound files, adjust how the oscillator frequency is manipulated, adjust the volume of each signal, and adjust how the volume, center frequency, bandwidth, delay time, and feedback strength are manipulated.

GLOBAL

- Turn audio on and off (x = on)
- Initiate breakpoint execution(s)
- Determine total length for all breakpoint files
- Initiate random number generation

RING MODULATION

Choose the original signal

- 1 Soundfile 1
- 2 Soundfile 2
- 3 None

Choose the modulating signal

- 1 Soundfile 3
- 2 Soundfile 4
- 3 Oscillator
- 4 None

Choose how to manipulate oscillator frequency

- 1 Breakpoint
- 2 Manual slider
- 3 Random/ regular/smooth
- 4 Random/ regular/abrupt
- 5 Random/ random/smooth
- 6 Random/ random/abrupt

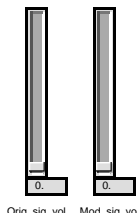

Start all soundfiles

Soundfile 1
 open pause resume

Soundfile 2
 open pause resume

Soundfile 3
 open pause resume

Soundfile 4
 open pause resume

clear
 1 - breakpoint

2 - slidr
 rate (sec)

3 - adjusts rand. # gen. rate
 rate (sec)

4 - adjusts rand. # gen. rate
 rate (sec)

output

5 - output

6 - output

Choose how to manipulate volume

- 1 Breakpoint
- 2 Manual slider
- 3 Random/ regular/smooth
- 4 Random/ regular/abrupt
- 5 Random/ random/smooth
- 6 Random/ random/abrupt

clear
 1 - breakpoint

2 - slidr
 rate (sec)

3 - adjusts rand. # gen. rate
 rate (sec)

4 - adjusts rand. # gen. rate
 rate (sec)

5 - output

6 - output

output

output

FILTER

Choose how to manipulate center frequency

- 1 Breakpoint
- 2 Manual slider
- 3 Random/ regular/smooth
- 4 Random/ regular/abrupt
- 5 Random/ random/smooth
- 6 Random/ random/abrupt

clear
 1 - breakpoint

2 - slidr
 rate (sec)

3 - adjusts rand. # gen. rate
 rate (sec)

4 - adjusts rand. # gen. rate
 rate (sec)

5 - output

6 - output

output

output

Choose how to manipulate bandwidth

- 1 Breakpoint
- 2 Manual slider
- 3 Random/ regular/smooth
- 4 Random/ regular/abrupt
- 5 Random/ random/smooth
- 6 Random/ random/abrupt

clear
 1 - breakpoint

2 - slidr
 rate (sec)

3 - adjusts rand. # gen. rate
 rate (sec)

4 - adjusts rand. # gen. rate
 rate (sec)

5 - output

6 - output

output

output

DELAY

Choose how to manipulate the delay time

- 1 Breakpoint
- 2 Manual slider
- 3 Random/ regular/smooth
- 4 Random/ regular/abrupt
- 5 Random/ random/smooth
- 6 Random/ random/abrupt

clear
 1 - breakpoint

2 - slidr
 rate (sec)

3 - adjusts rand. # gen. rate
 rate (sec)

4 - adjusts rand. # gen. rate
 rate (sec)

5 - output

6 - output

output

output

Choose how to manipulate the breakpoint strength

- 1 Breakpoint
- 2 Manual slider
- 3 Random/ regular/smooth
- 4 Random/ regular/abrupt
- 5 Random/ random/smooth
- 6 Random/ random/abrupt

clear
 1 - breakpoint

2 - slidr
 rate (sec)

3 - adjusts rand. # gen. rate
 rate (sec)

4 - adjusts rand. # gen. rate
 rate (sec)

5 - output

6 - output

output

output

Ring-Filter-Delay.pat

Performance Score

1A

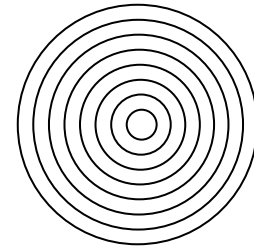

78126045

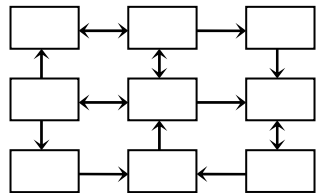

1B

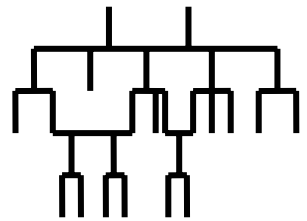
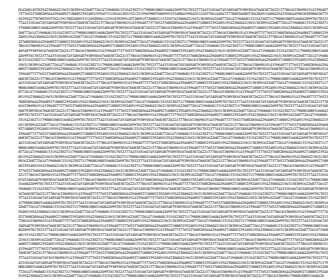
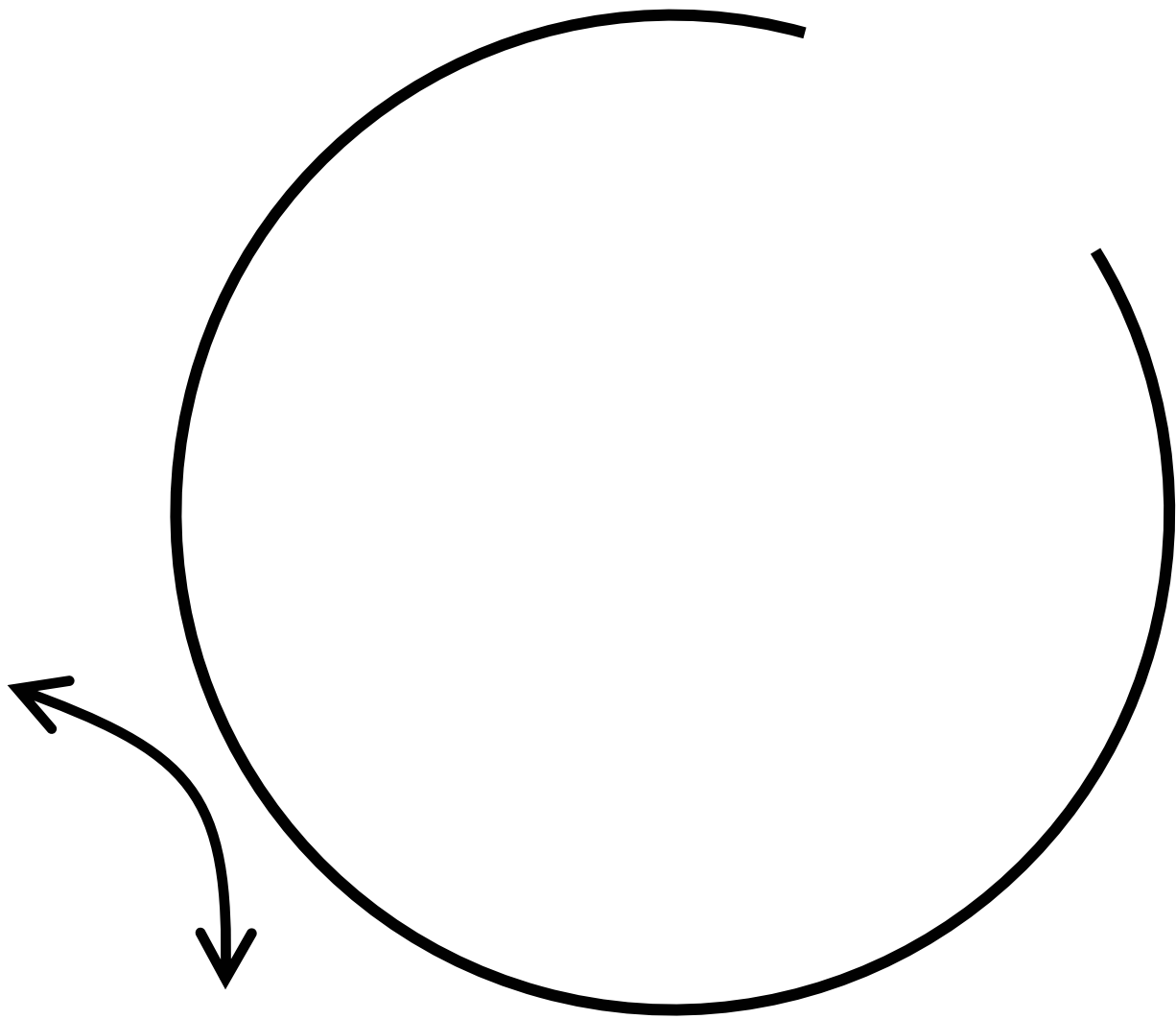

1C

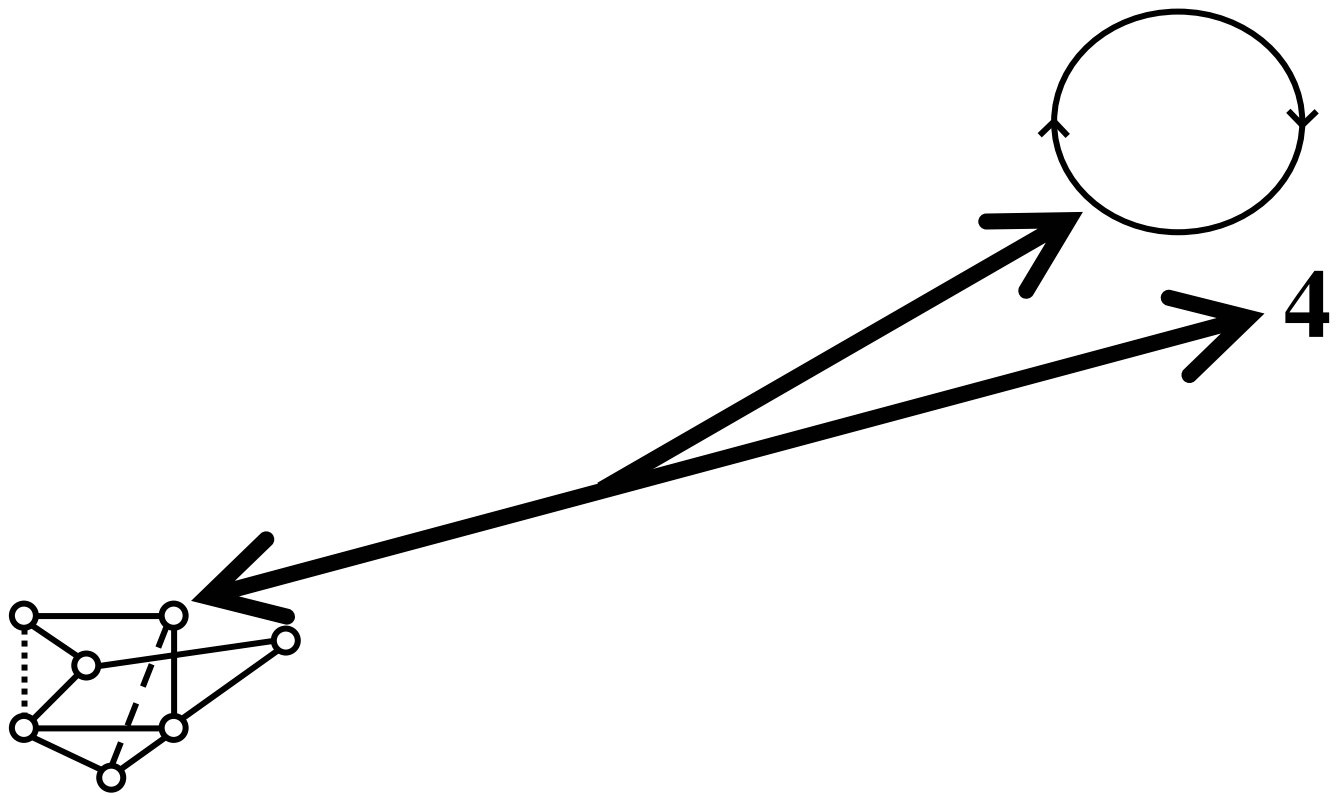

2A

78126045

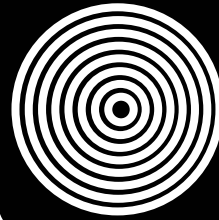
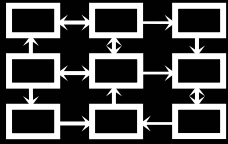

2C

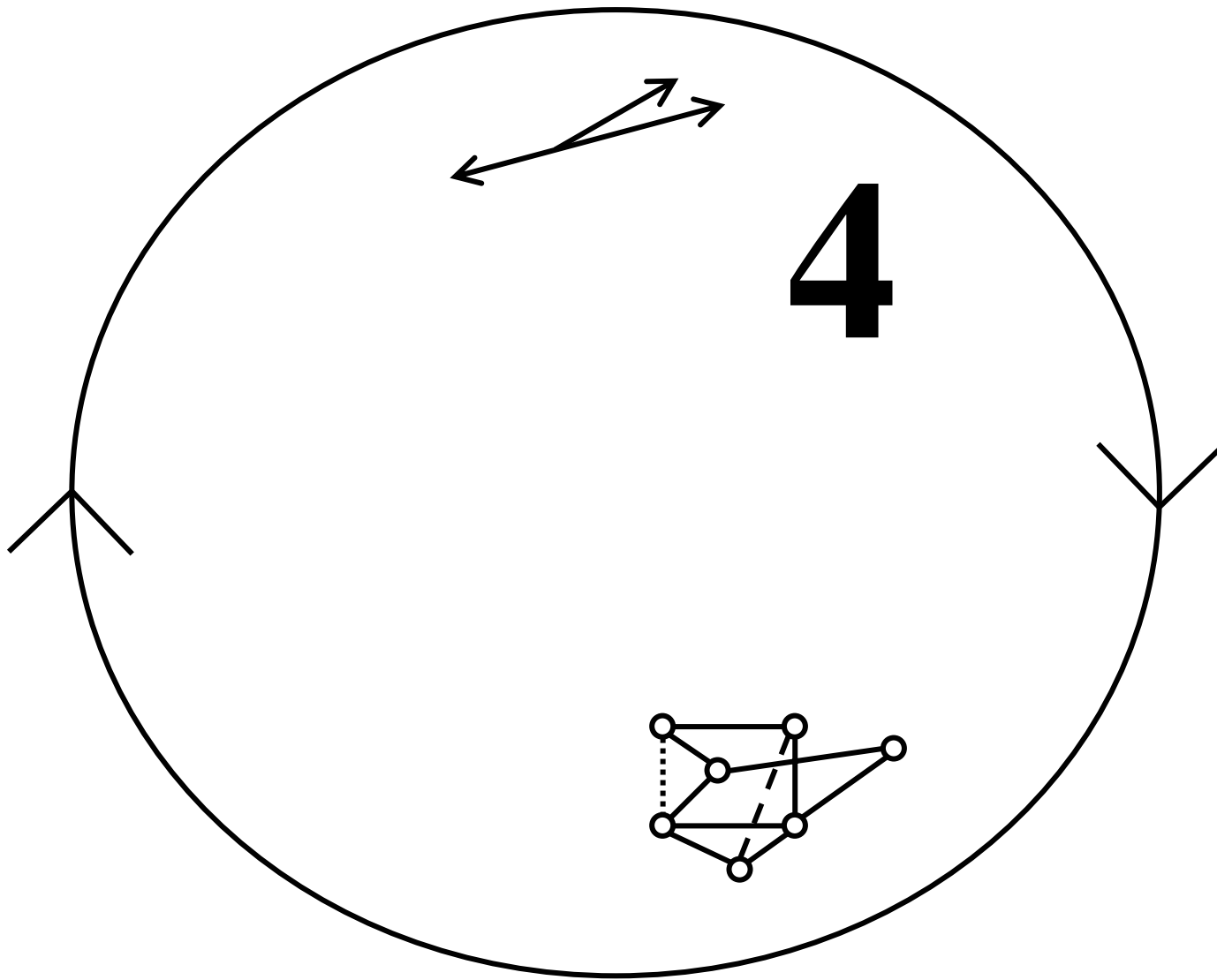

3C

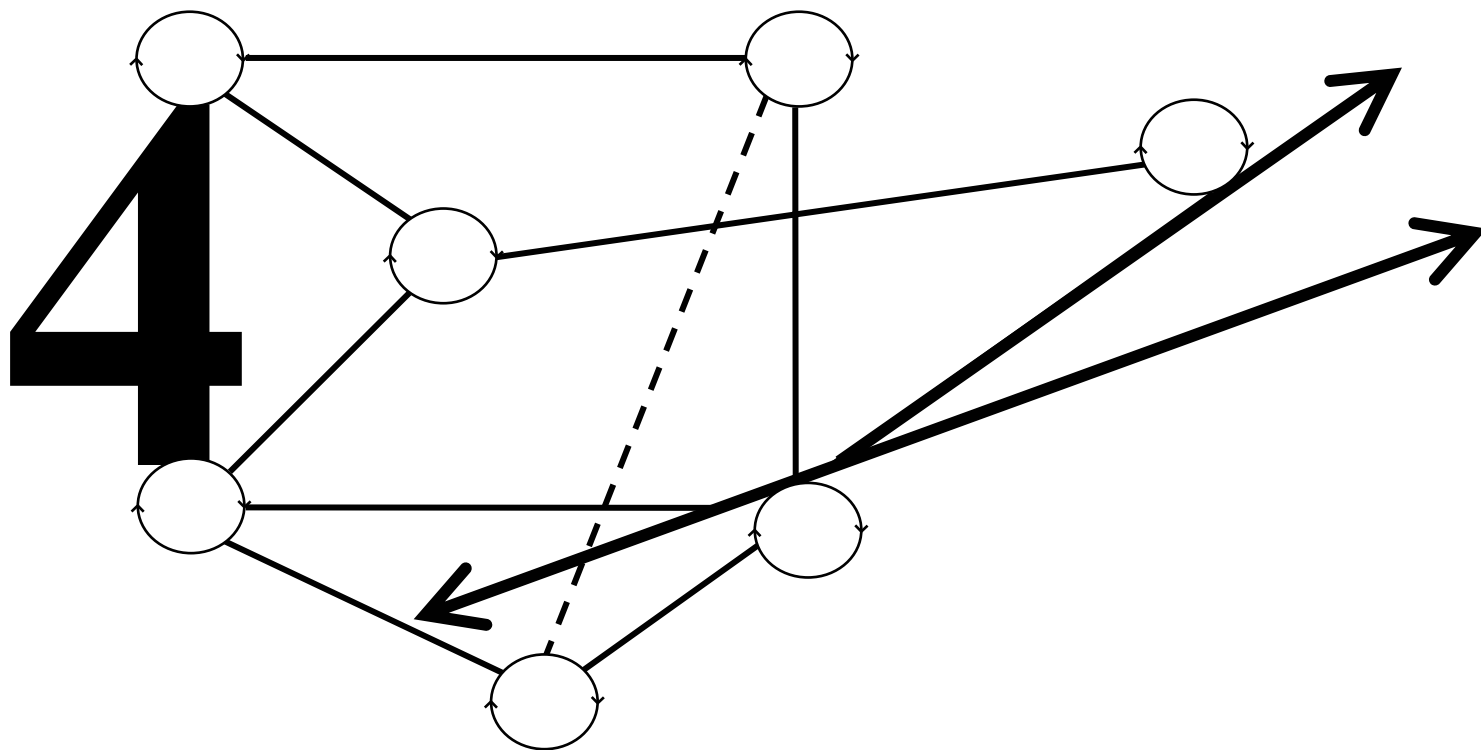

1A

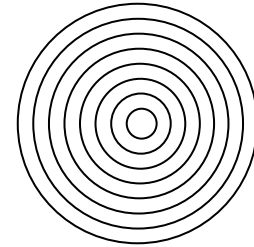
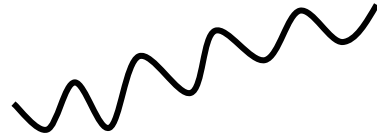

I 781 0 260 4 T 5

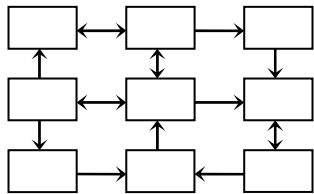

1B

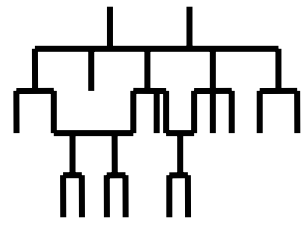
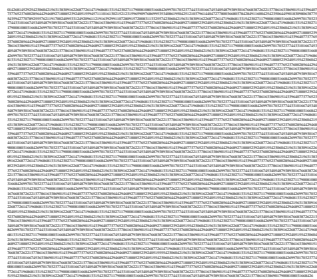
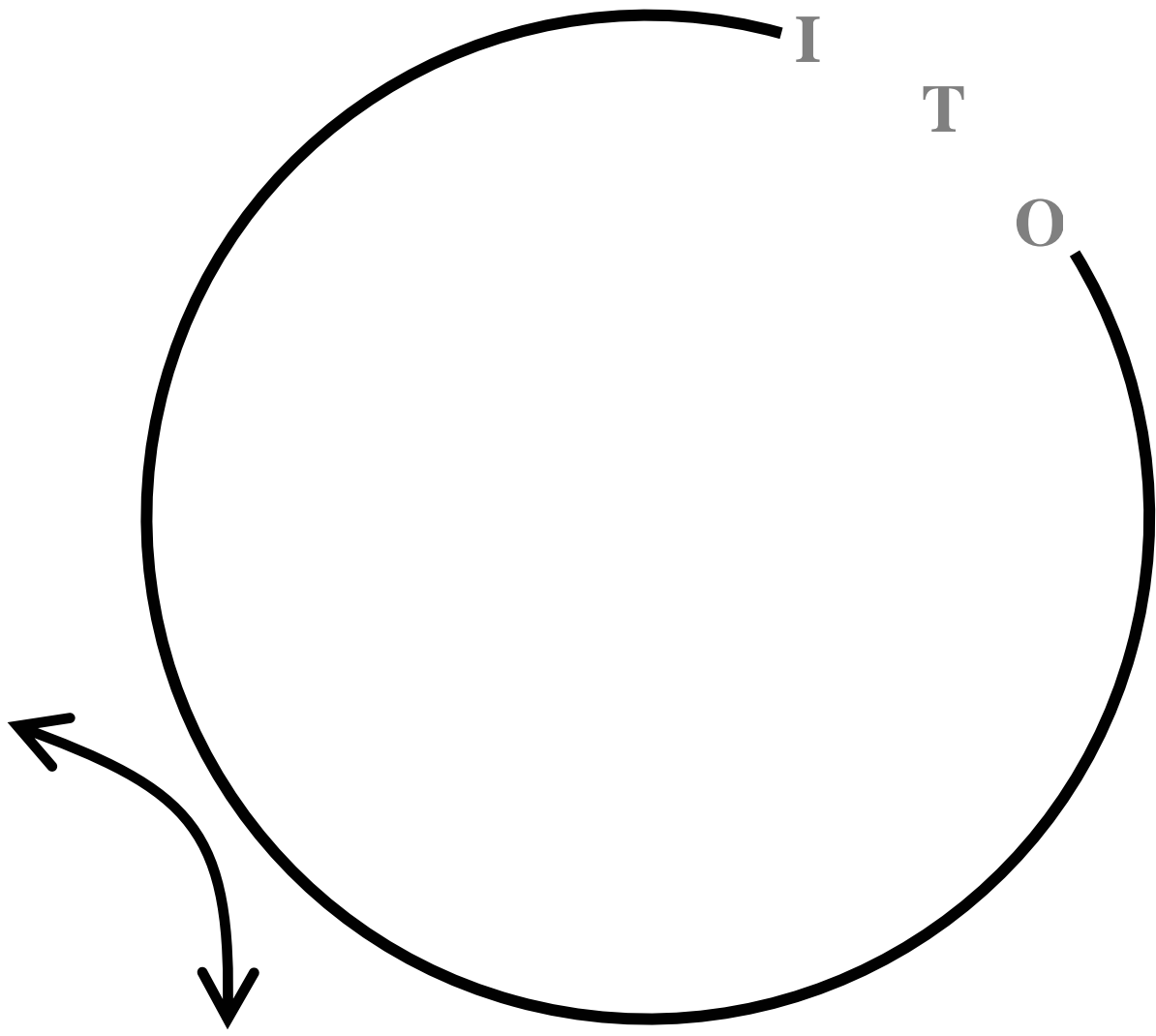

1C

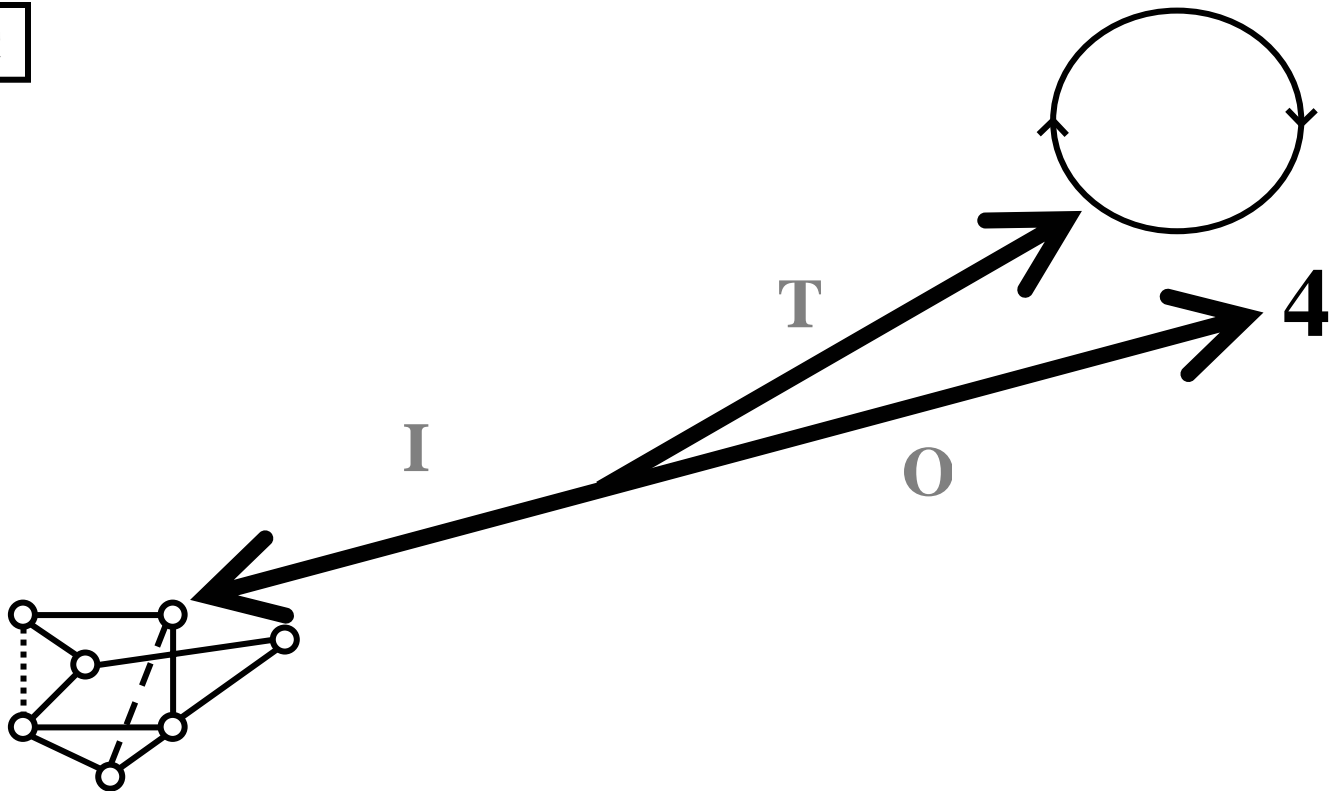

2A

T

78126045

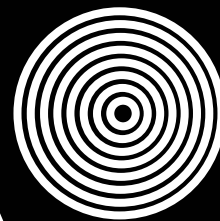
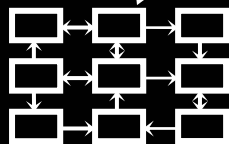

I

2C

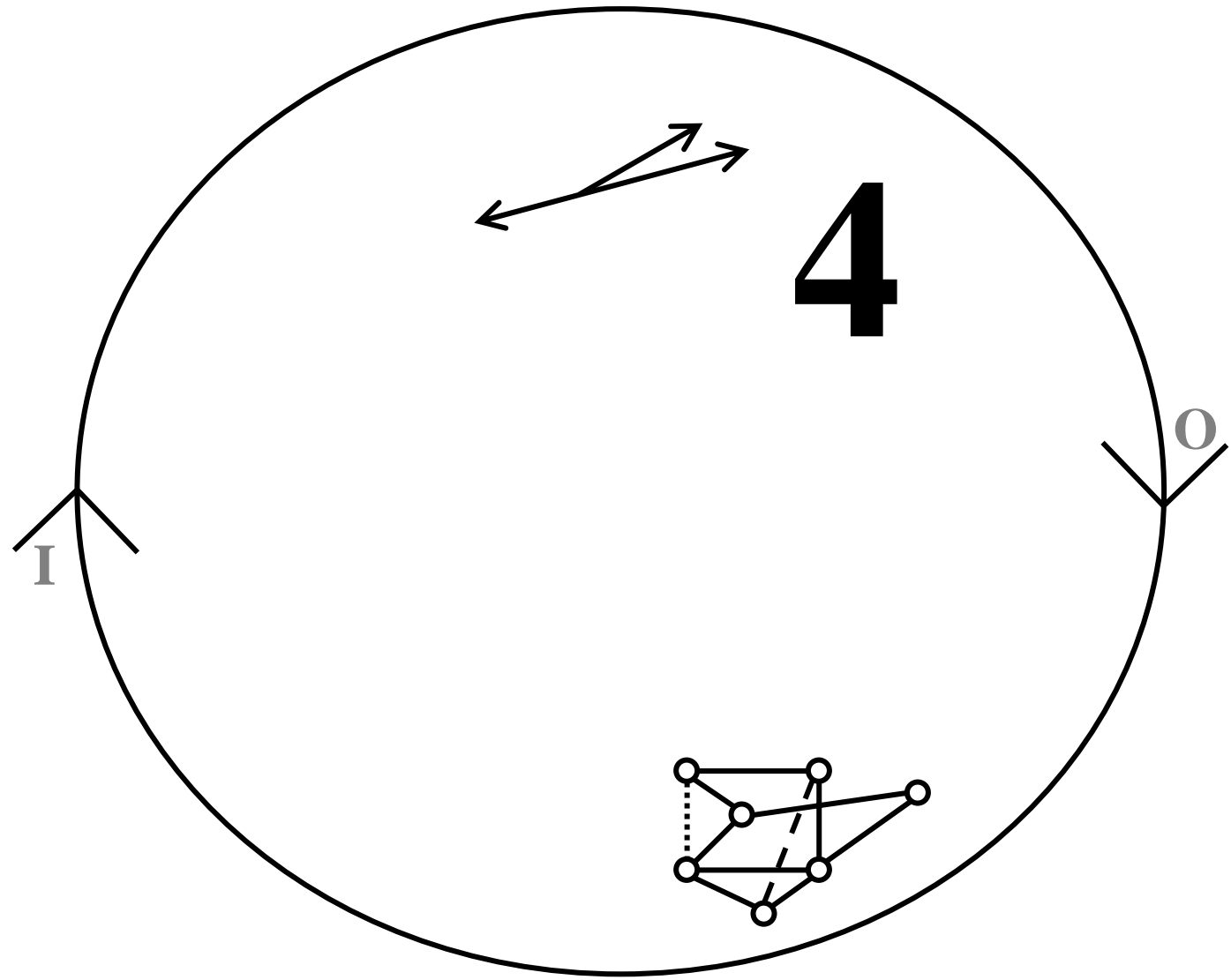

3A

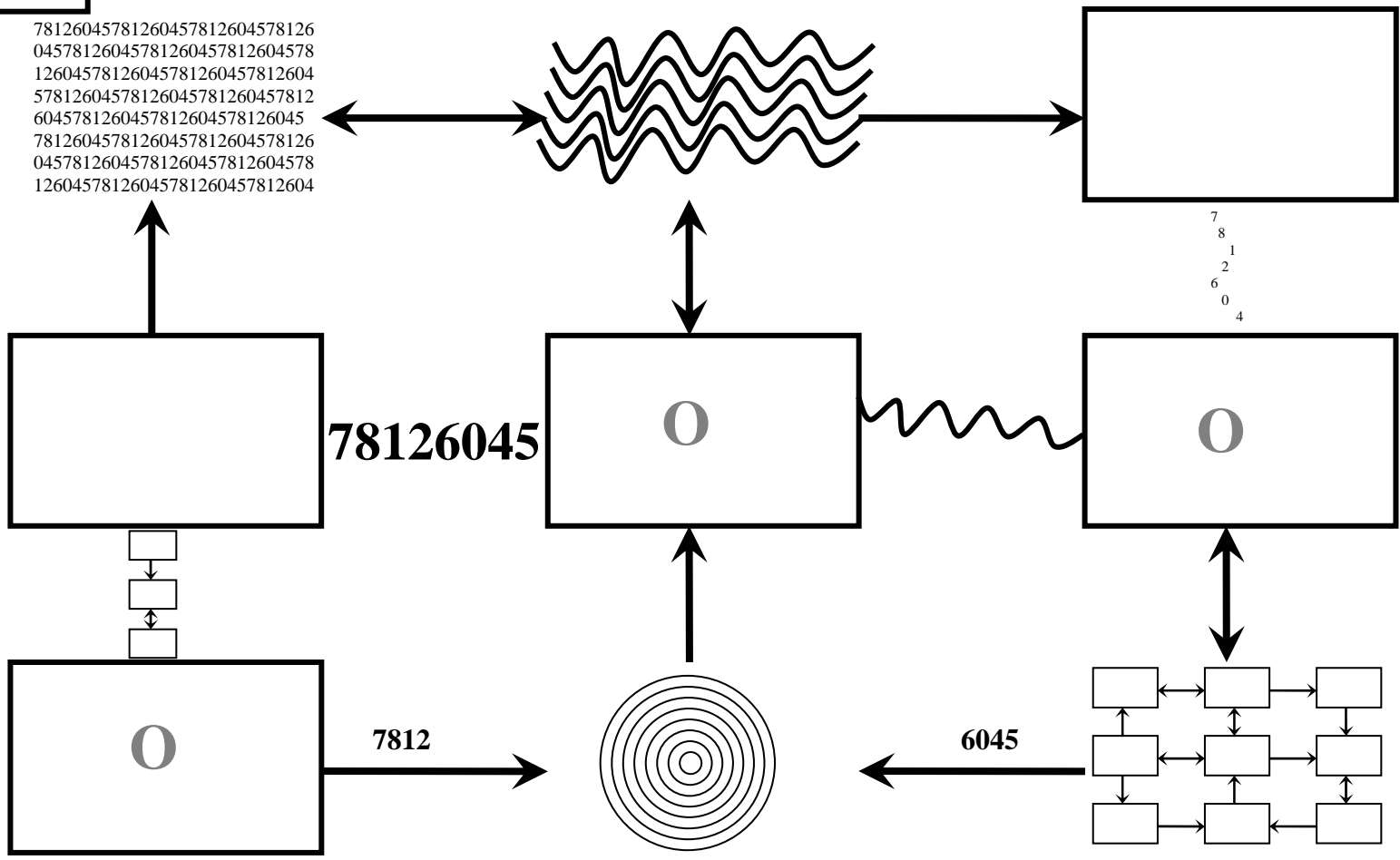

3C

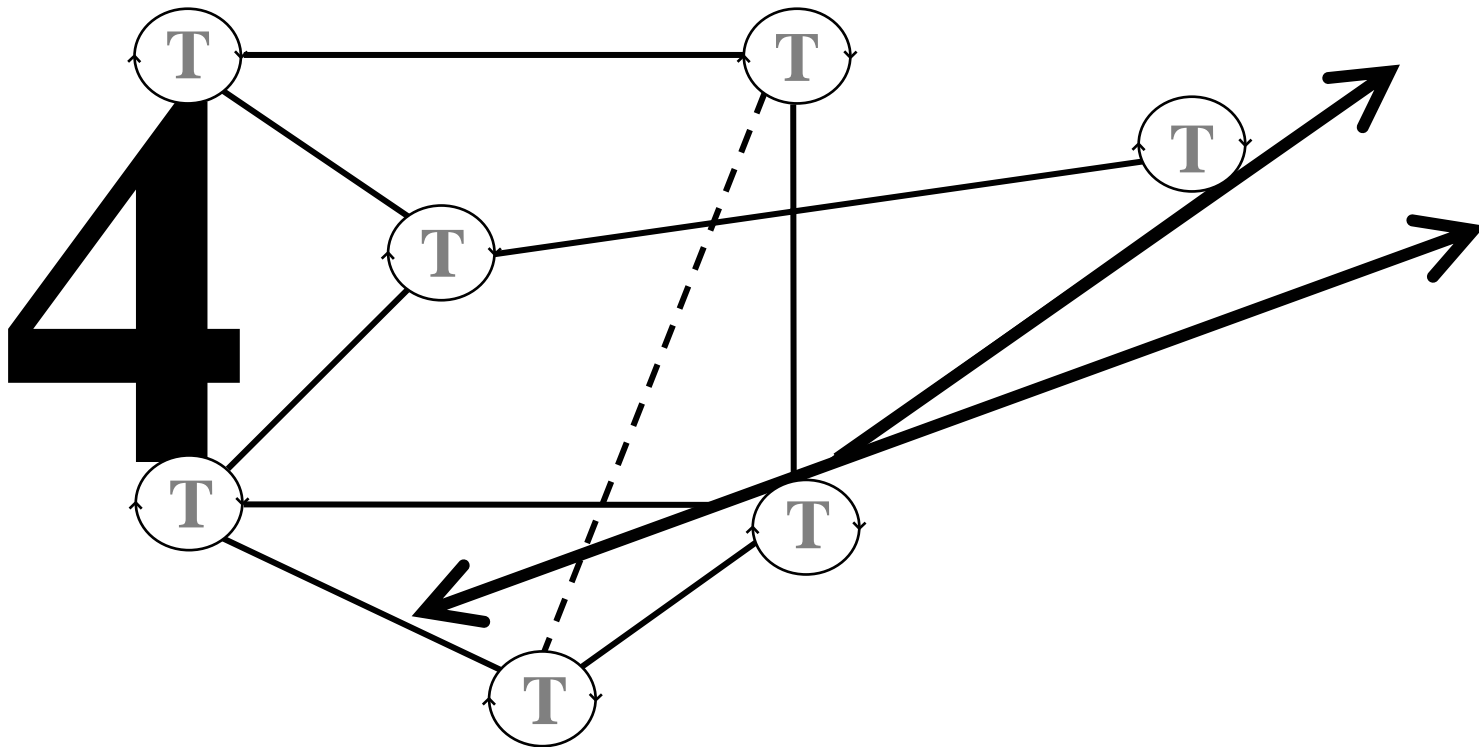

Appendix

MAX/MSP Patch Backgrounds and Subpatches

Ring.pat background

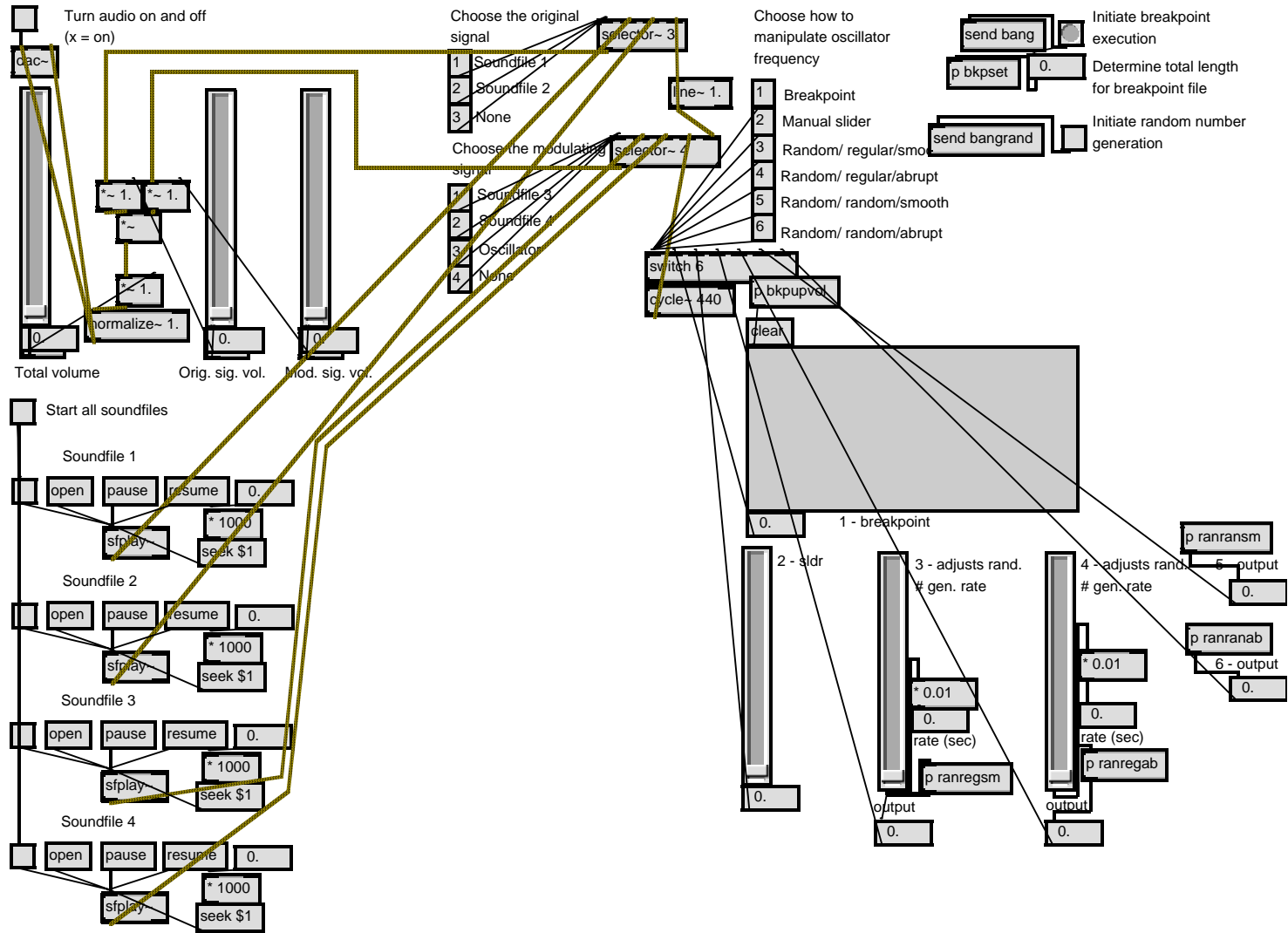

Ring.pat subpatches

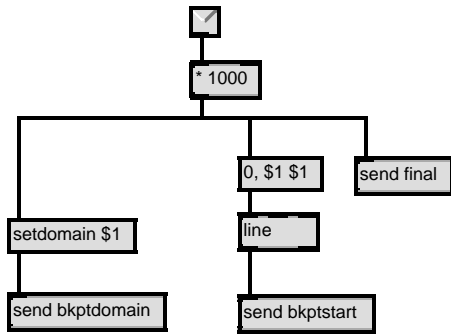

bkpset

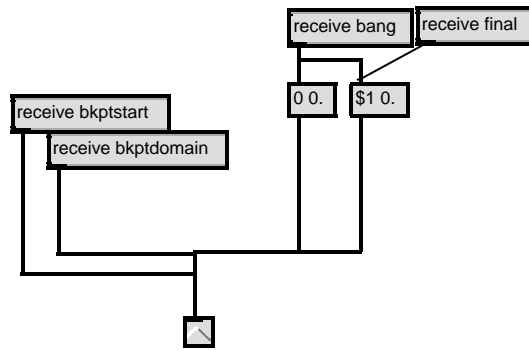

pkpupvol

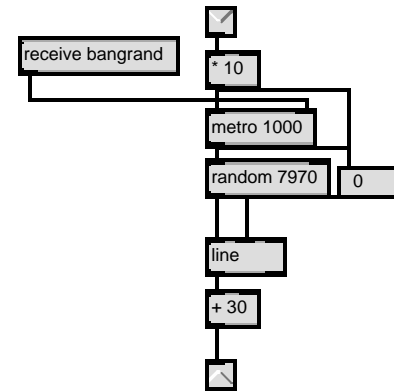

ranregsm

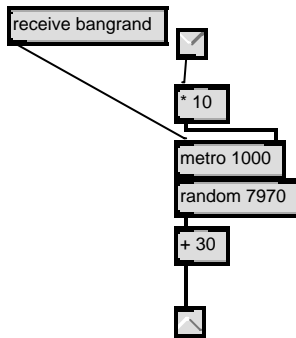

ranregab

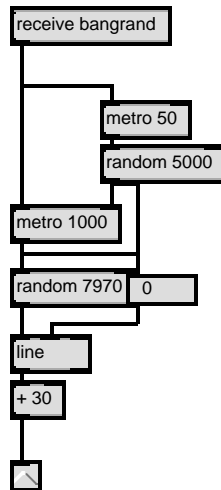

ranransm

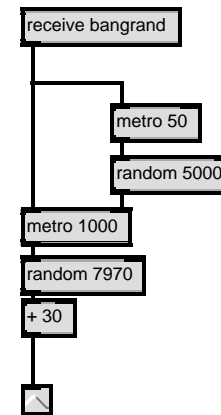

ranranab

Single Filter.pat subpatches

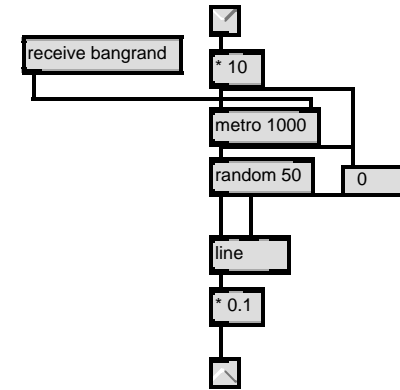
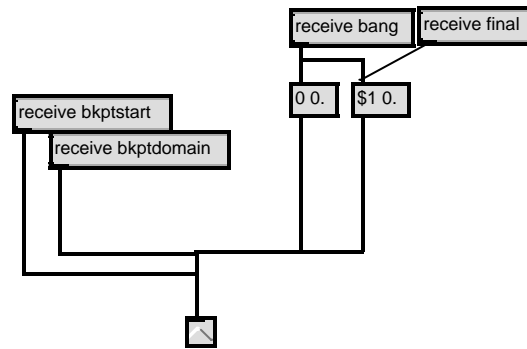
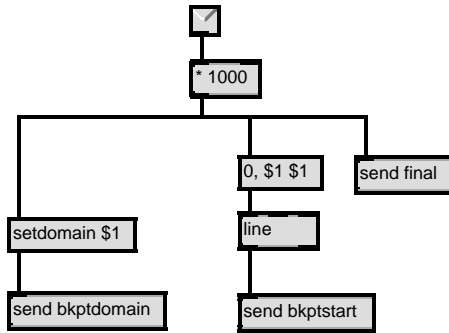

bkset

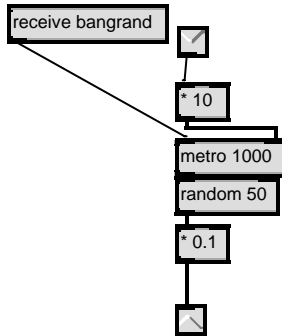

bkpupvol

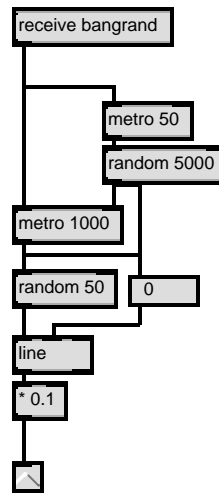

ranregsm

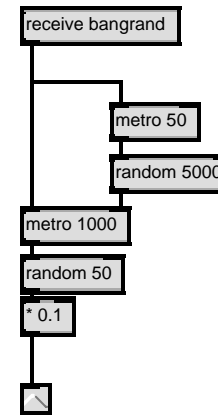

ranregab

ranransm

ranranab

Single Filter.pat subpatches continued

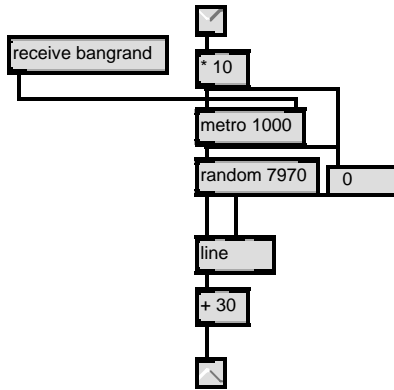

ranregsm2

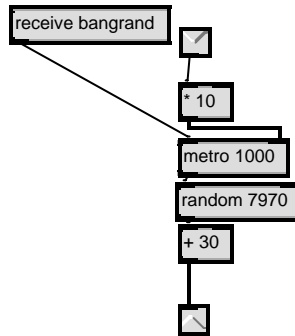

ranregab2

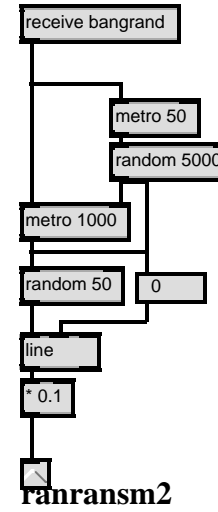

ranransm2

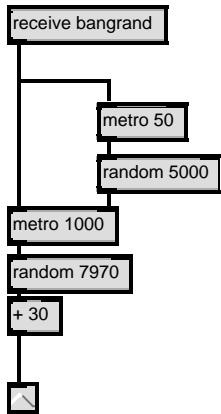

ranranab2

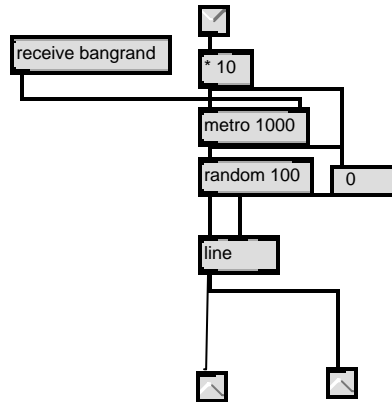

ranregsm3

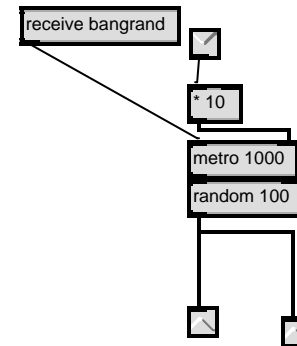

ranregab3

Single Filter.pat subpatches continued

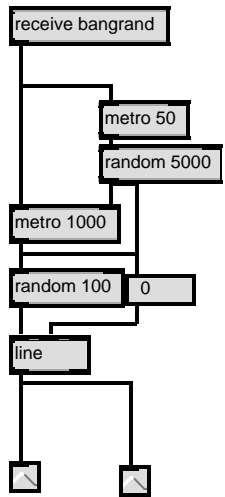

ranransm3

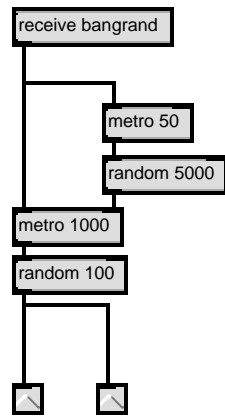

ranranab3

Single Delay.pat subpatches

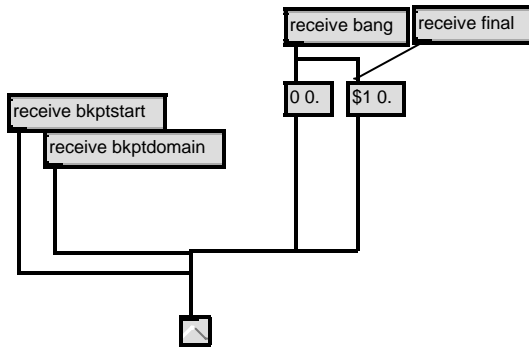

bkpupvol

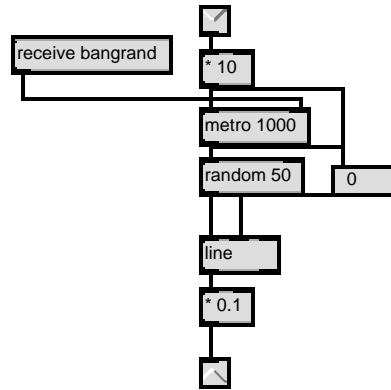

ranregsm

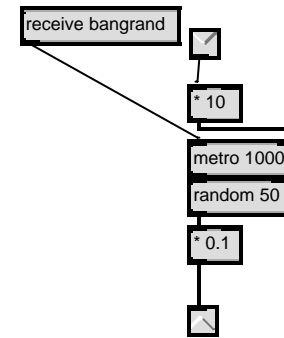

ranregab

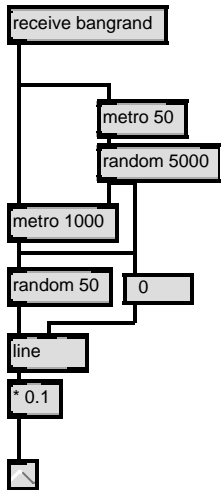

ranransm

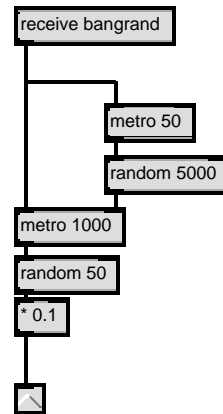

ranranab

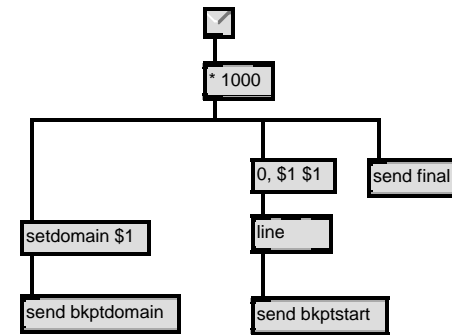

bkpset

Single Delay.pat subpatches continued

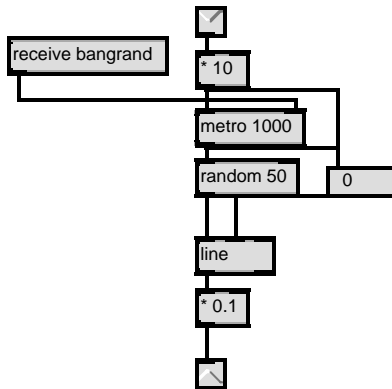

ranregsm2

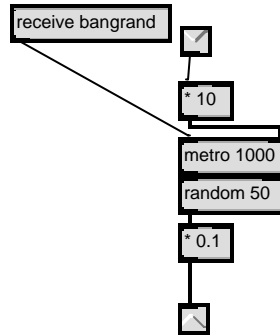

ranregab2

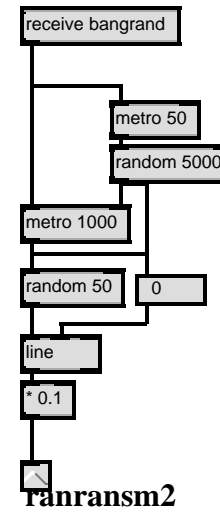

ranransm2

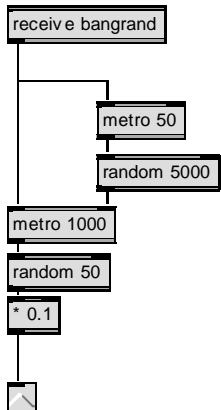

ranranab2

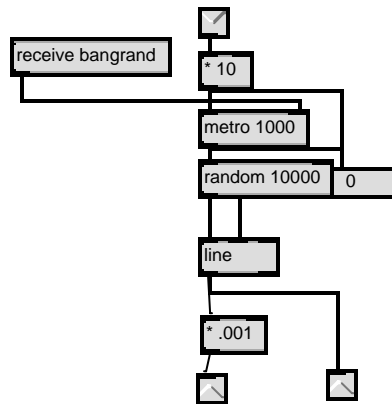

ranregsm3

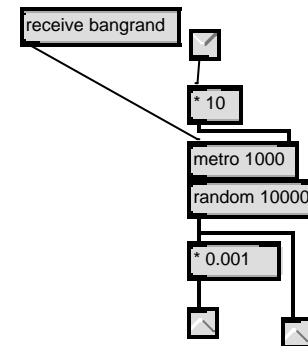

ranregab3

Single Delay.pat subpatches continued

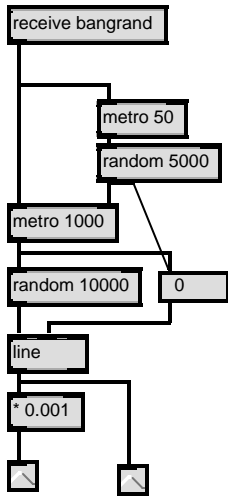

ranransm3

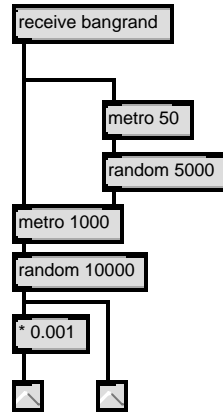

ranranab3

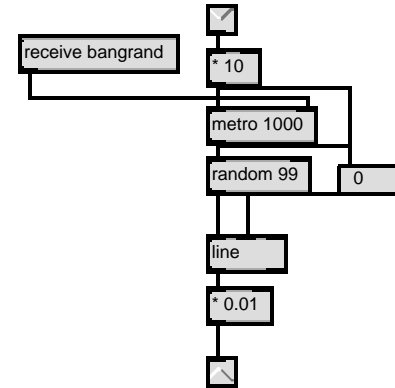

ranregsm4

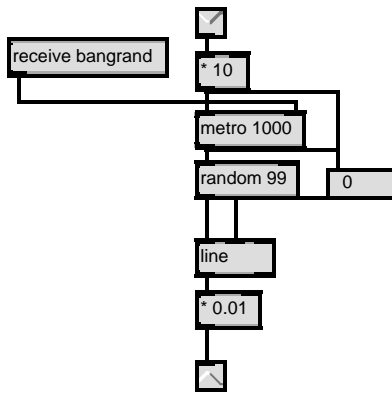

ranreab4

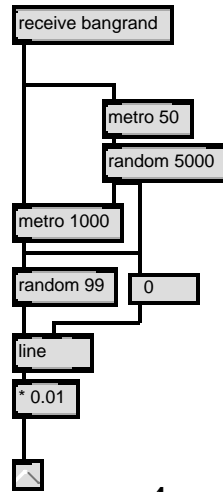

ranransm4

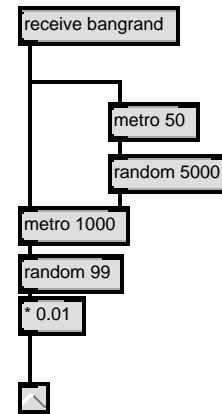

ranranab4

Multiple Filters.pat background

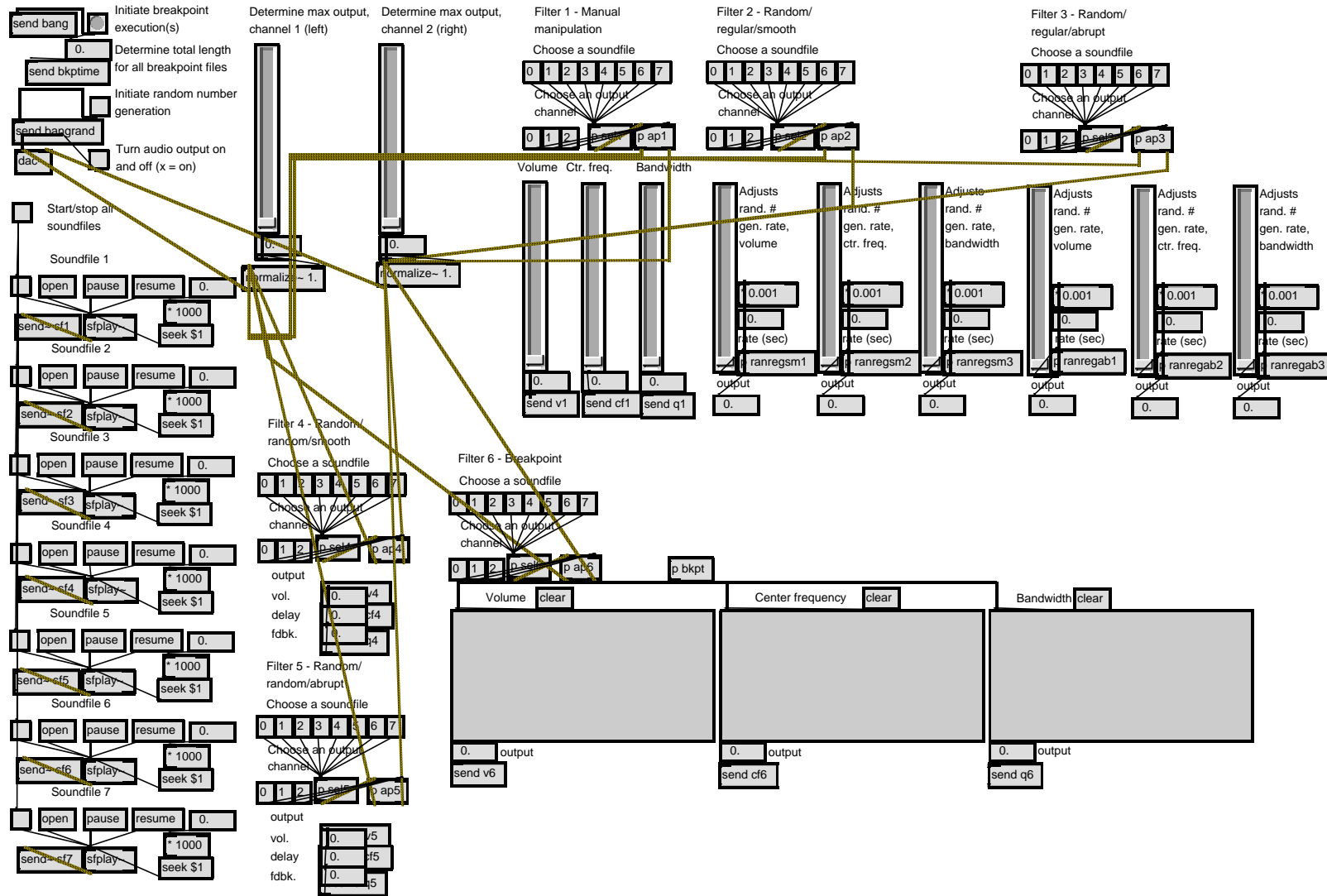

Multiple Filters.pat subpatches

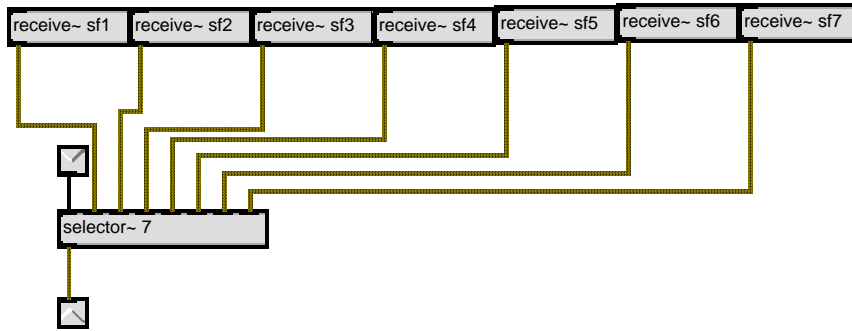

sel1

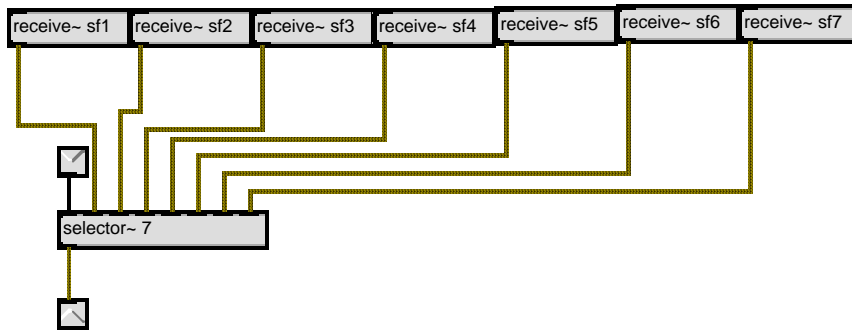

sel2

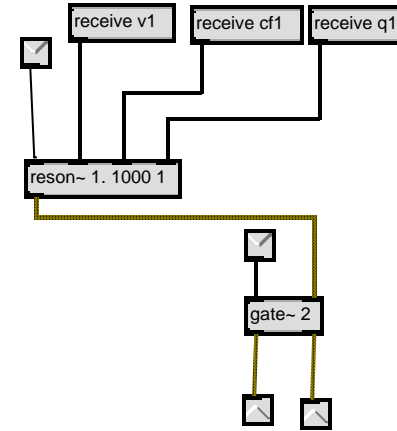

ap1

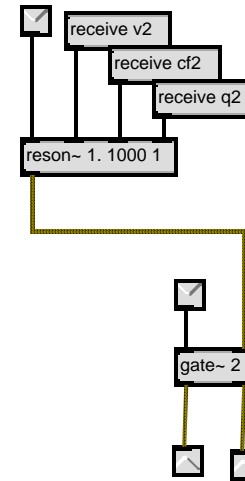

ap2

Multiple Filters.pat subpatches continued

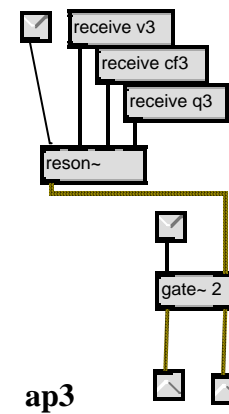
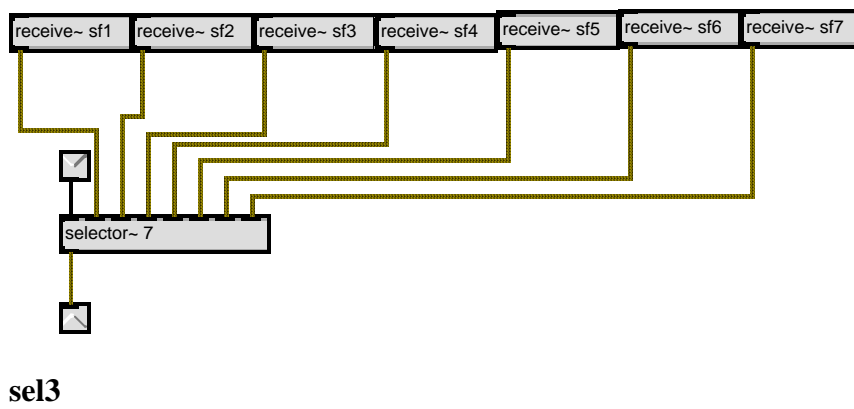
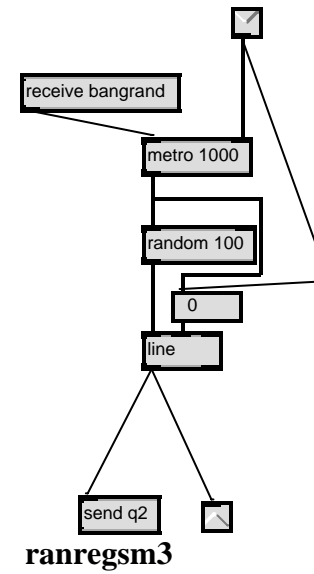
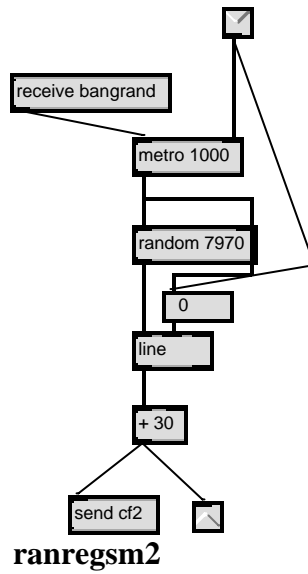
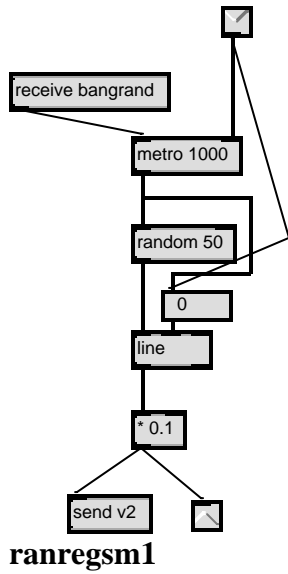

Multiple Filters.pat subpatches continued

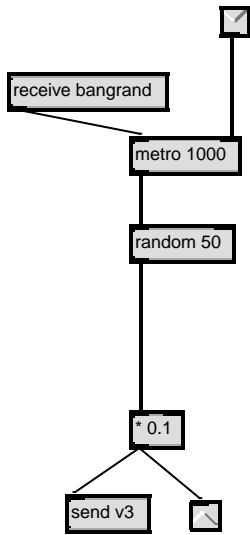

ranregab1

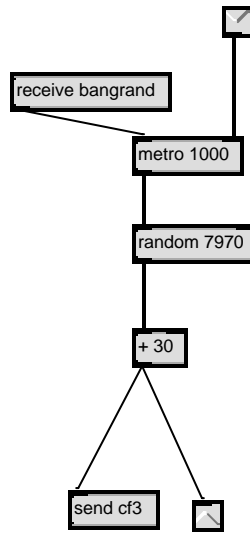

ranregab2

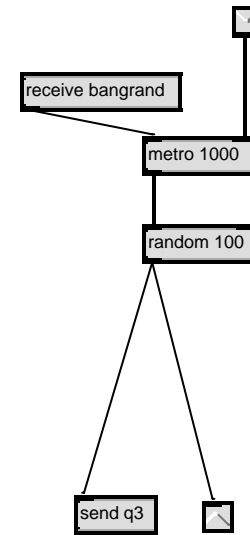

ranregab3

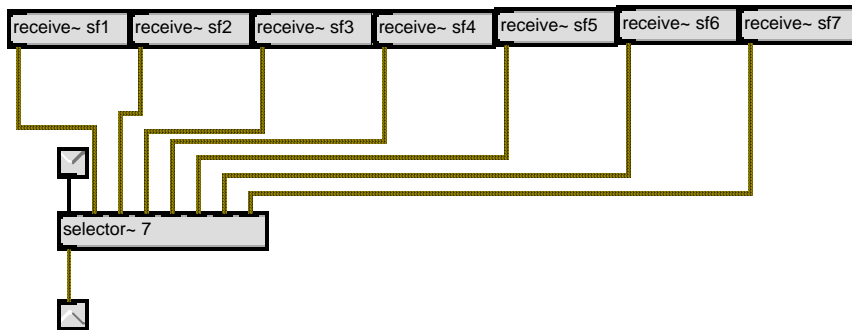

sel4

Multiple Filters.pat subpatches continued

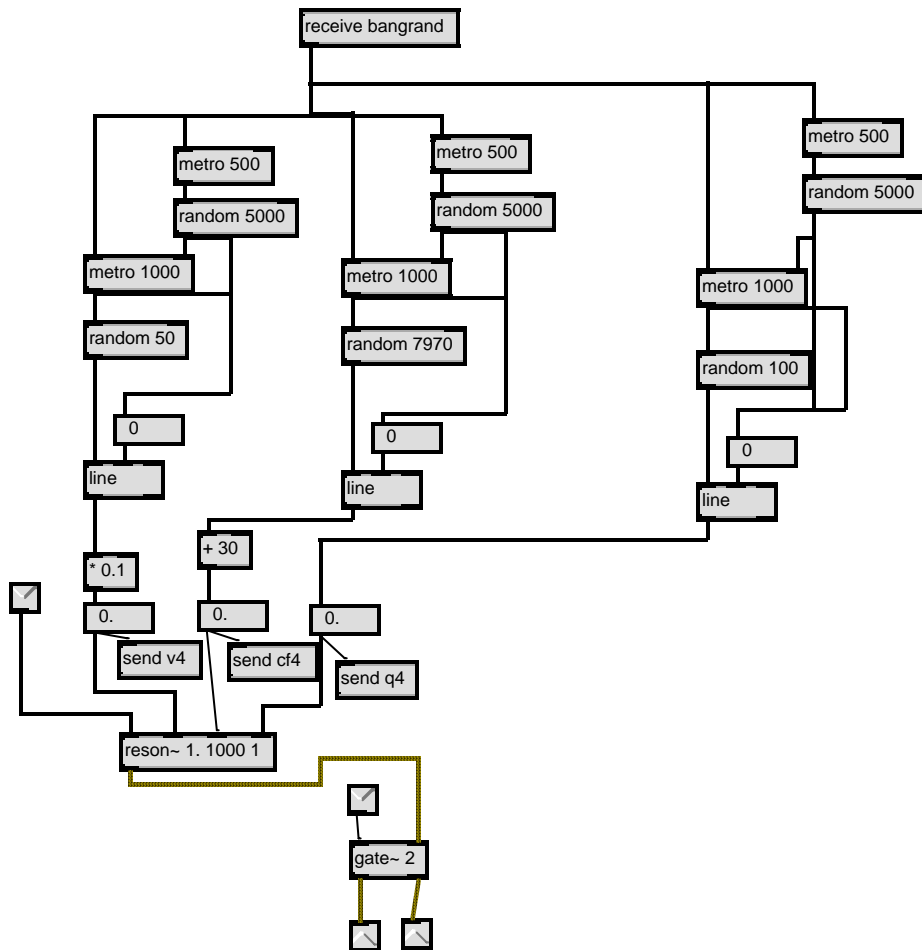

ap4

Multiple Filters.pat subpatches continued

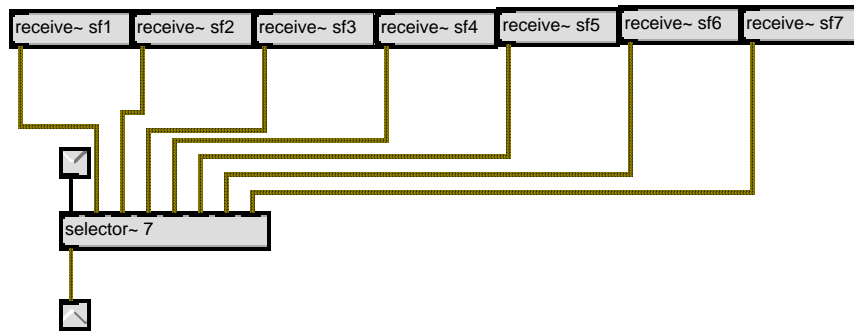

sel5

Multiple Filters.pat subpatches continued

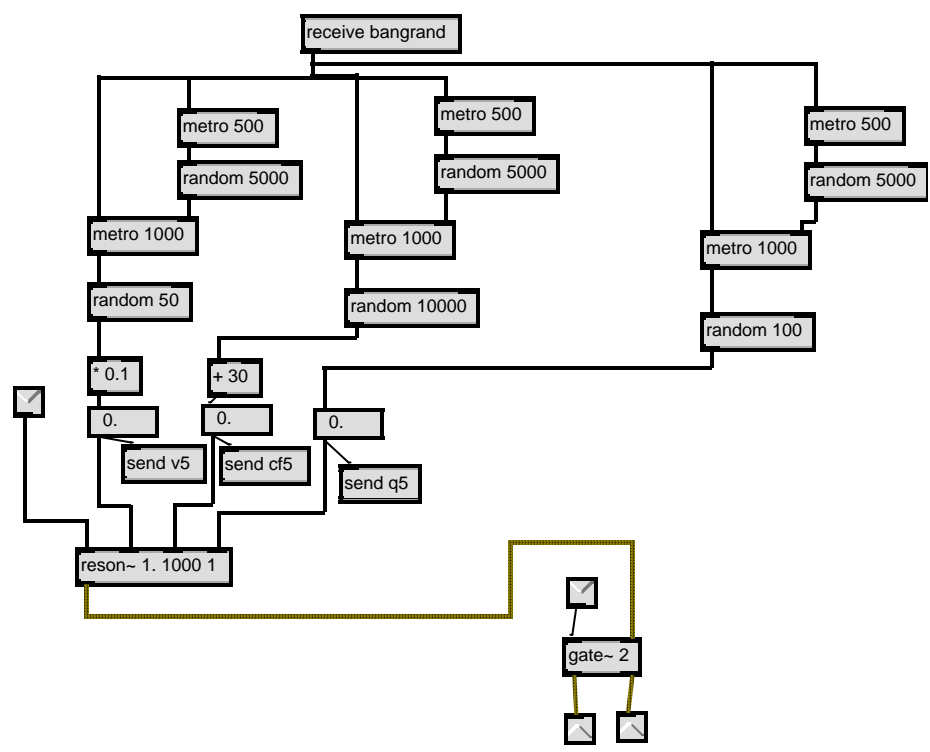

ap5

Multiple Filters.pat subpatches continued

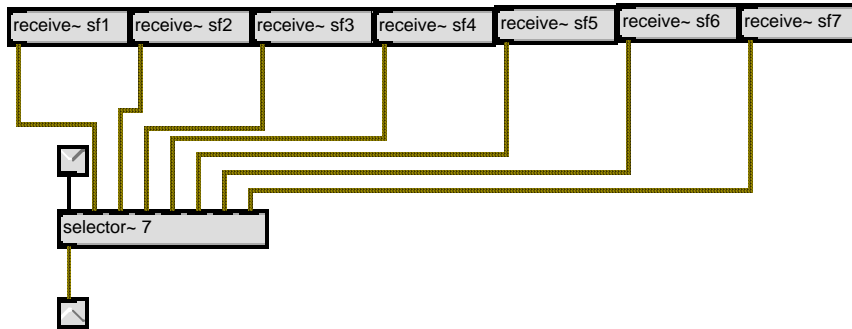

sel6

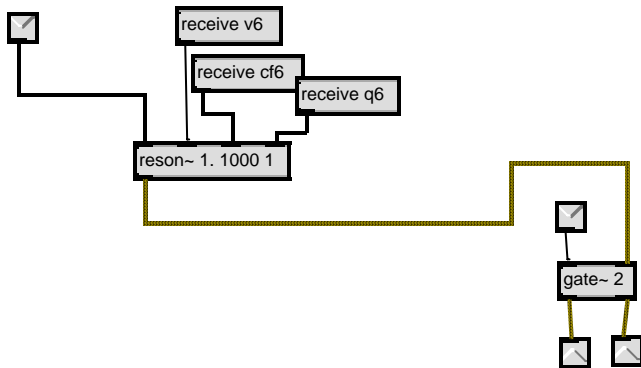

ap6

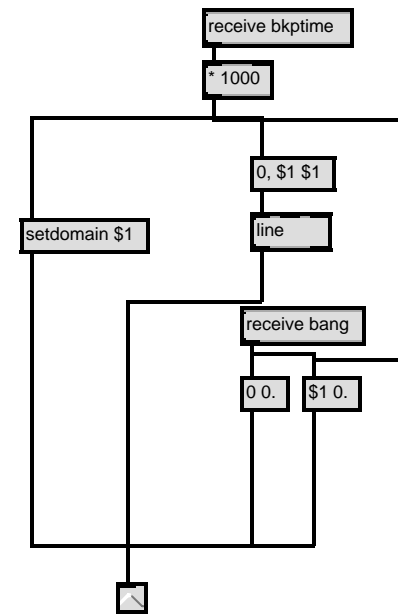

bkpt

Multiple Delays.pat background

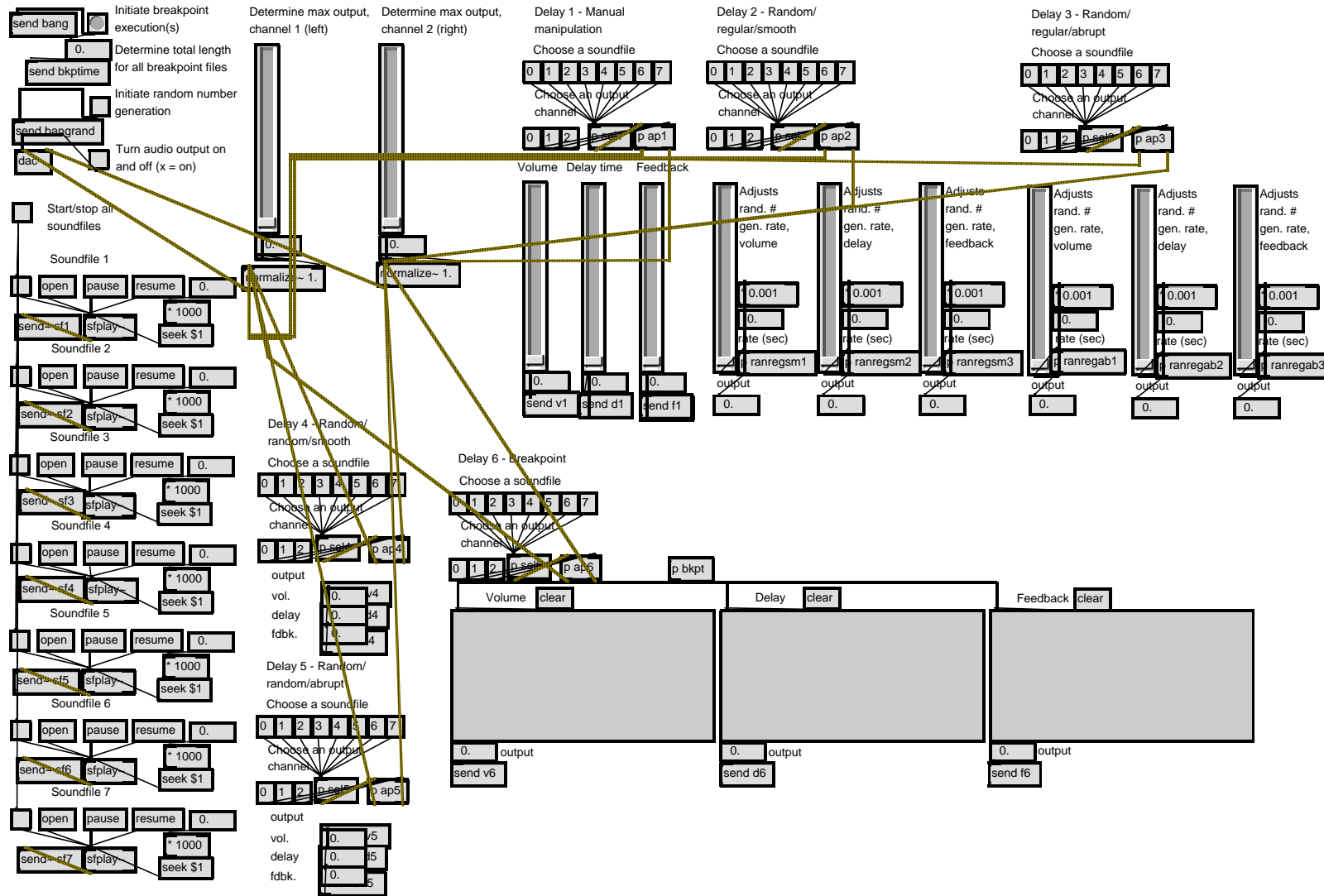

Multiple Delays.pat subpatches

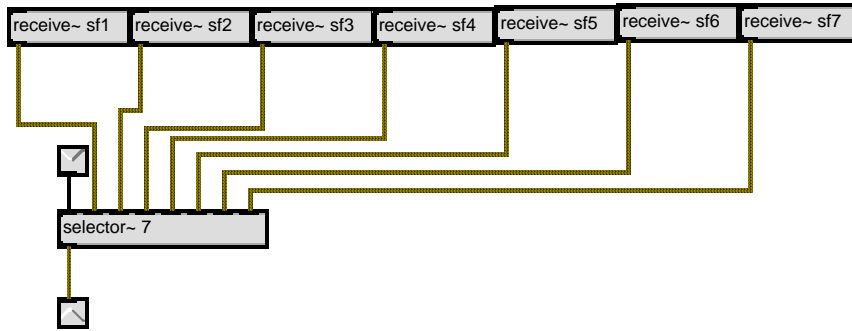

sel1

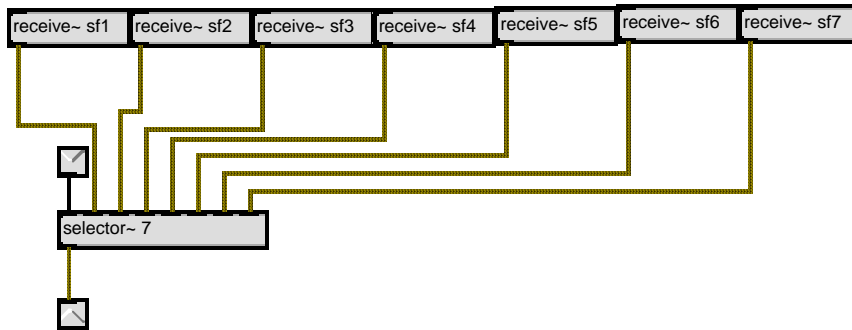

sel2

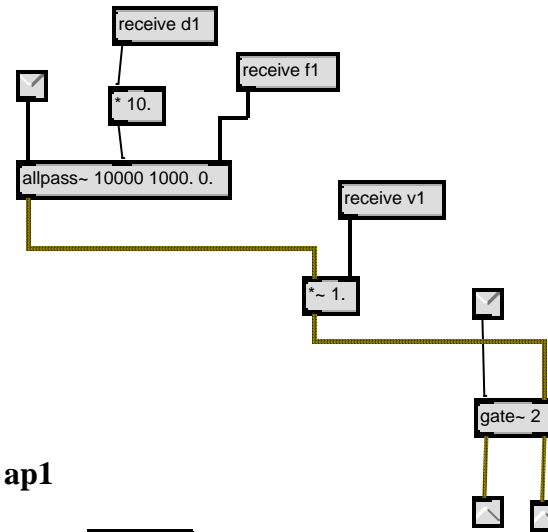

ap1

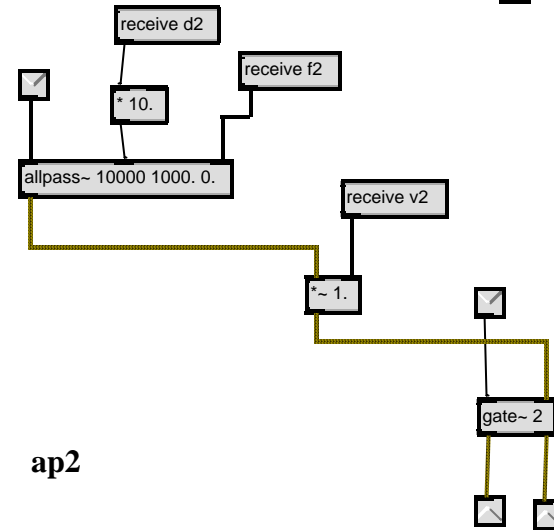

ap2

Multiple Delays.pat subpatches continued

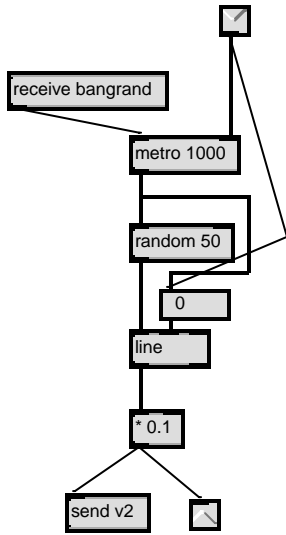

ranregsm1

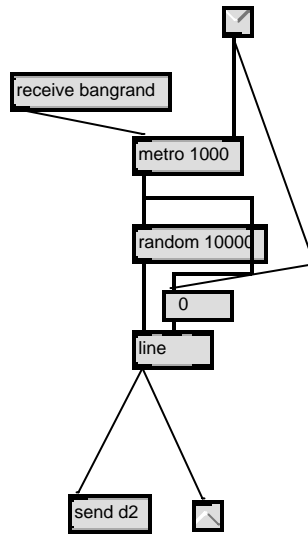

ranregsm2

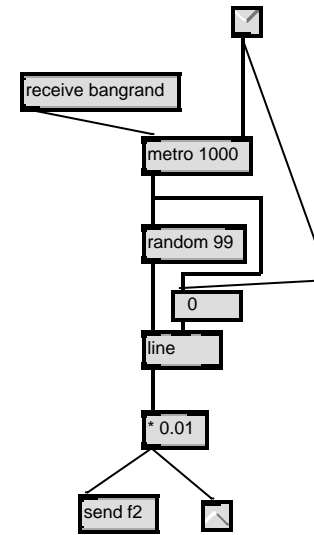

ranregsm3

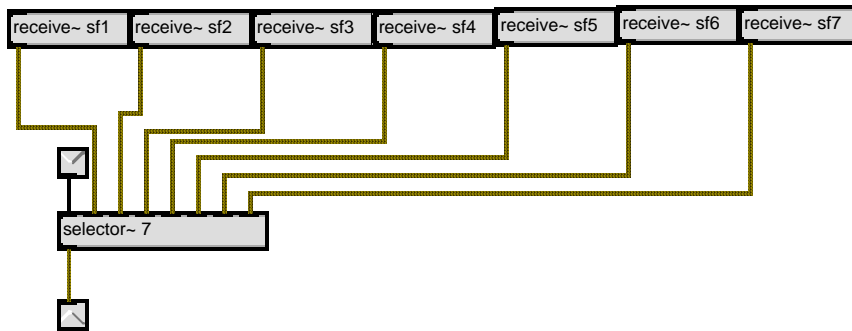

sel3

Multiple Delays.pat subpatches continued

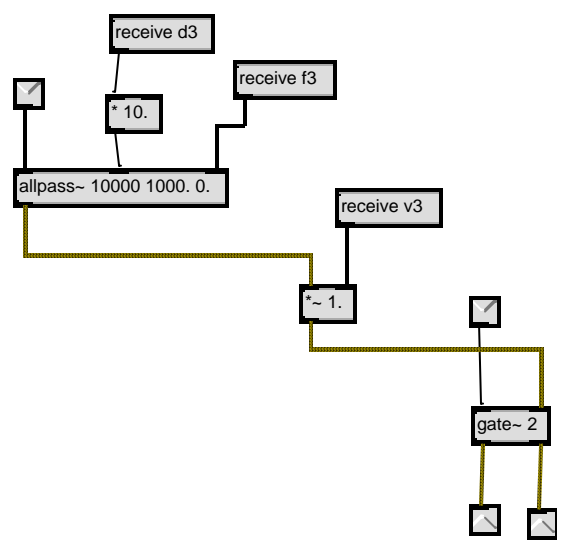

ap3

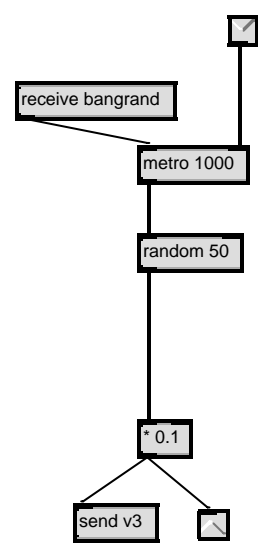

ranregab1

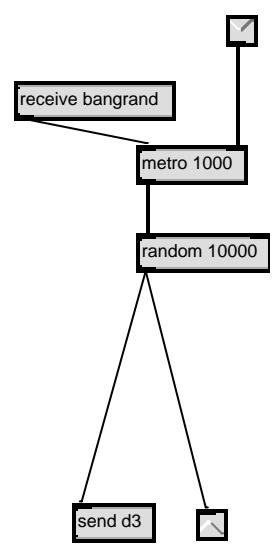

ranregab2

Multiple Delays.pat subpatches continued

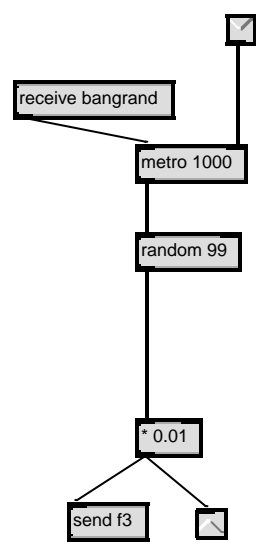

ranregab3

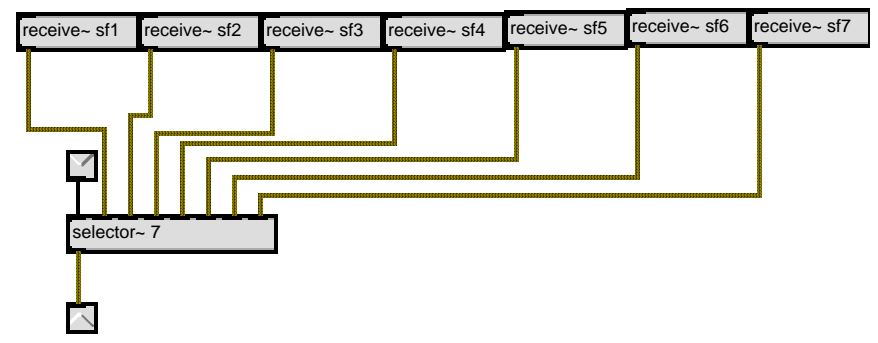

sel4

Multiple Delays.pat subpatches continued

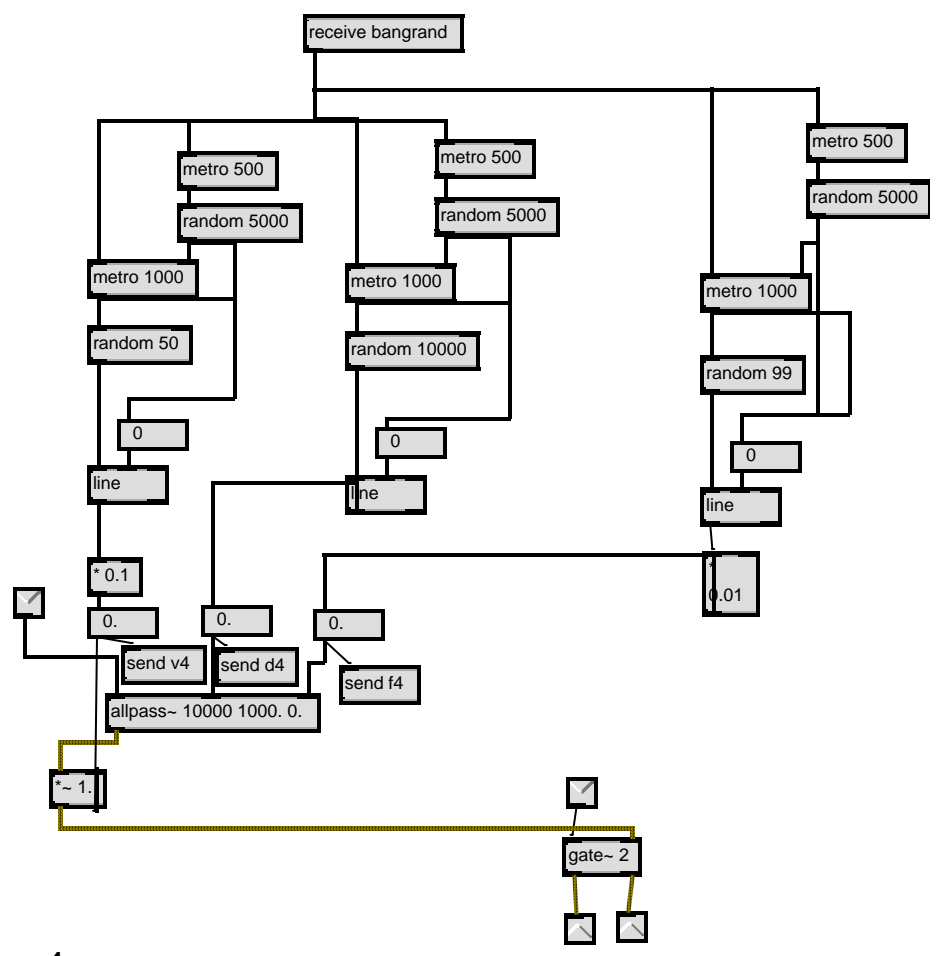

ap4

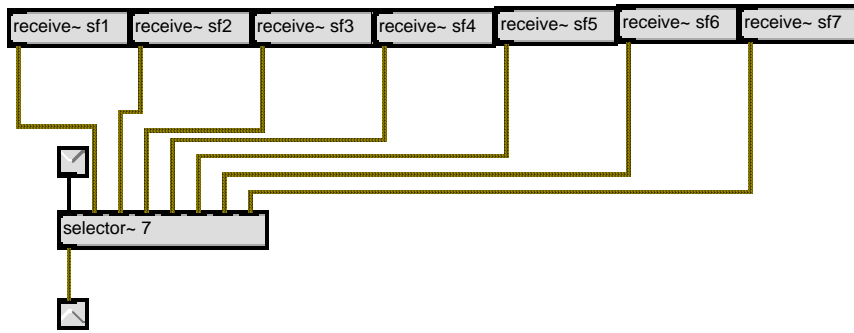

sel5

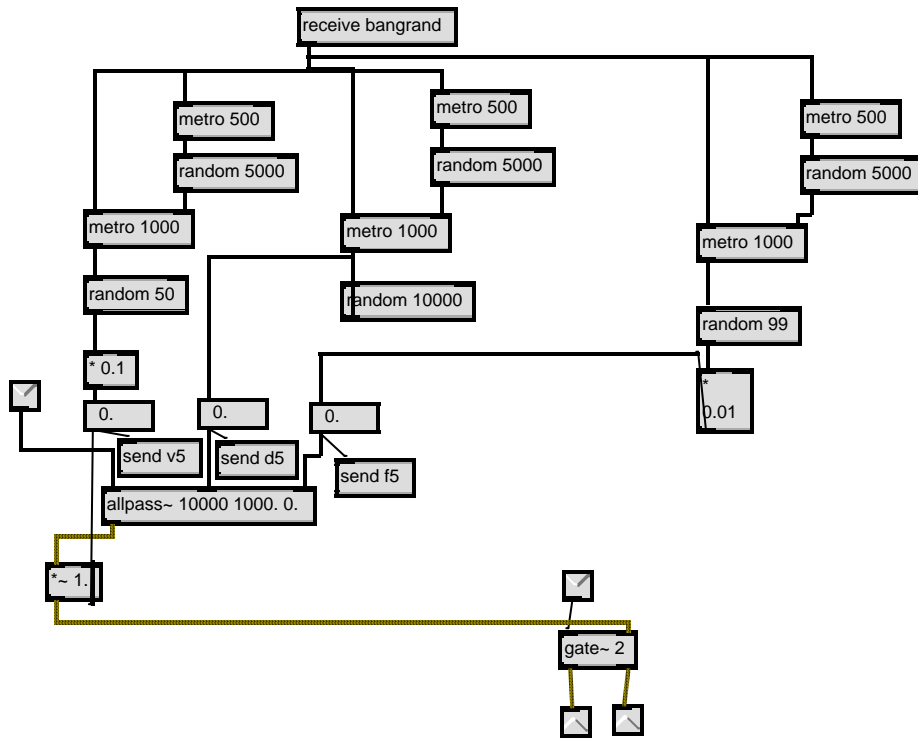

ap5

Multiple Delays.pat subpatches continued

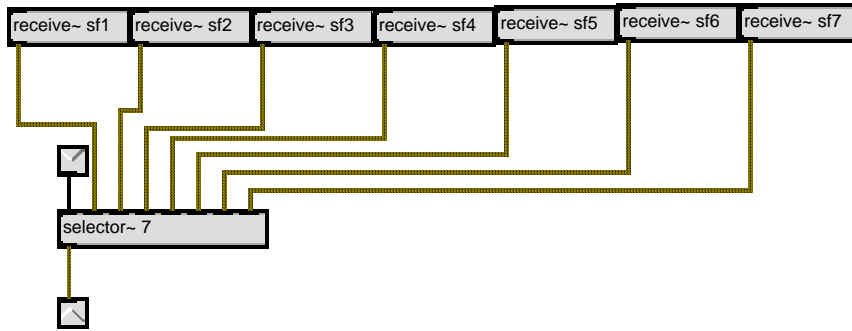

sel6

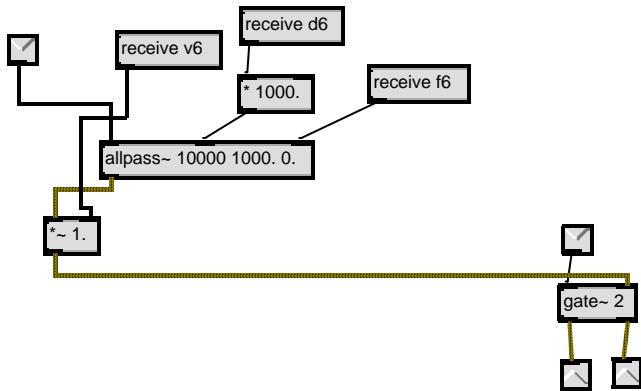

ap6

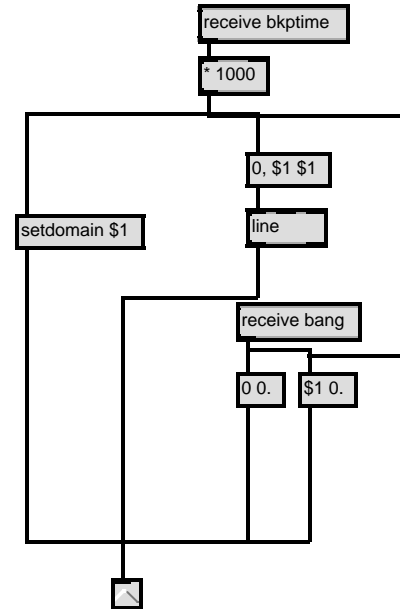

bkpt

Filter-Delay.pat subpatches

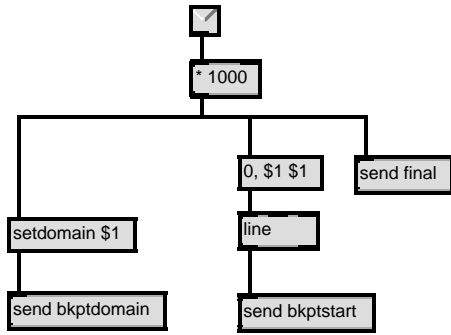

bkpset

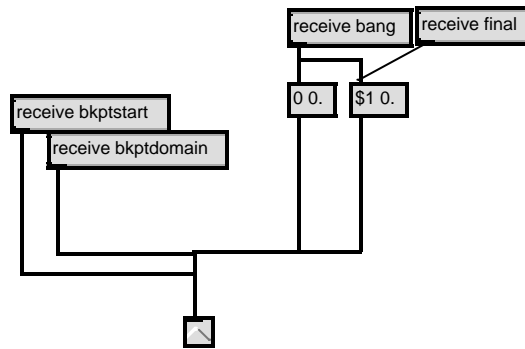

bkpupvol

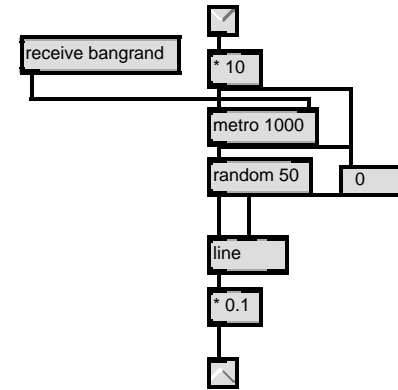

ranregsm

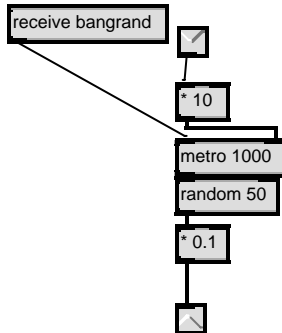

ranregab

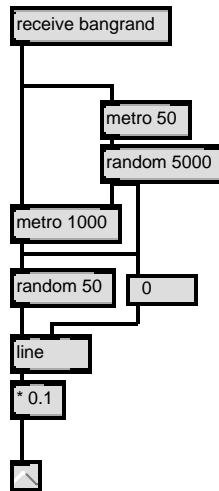

ranransm

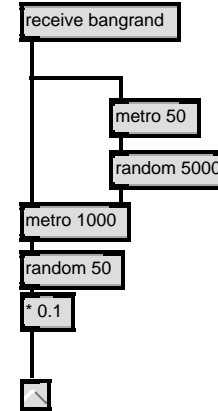

ranranab

Filter-Delay.pat subpatches continued

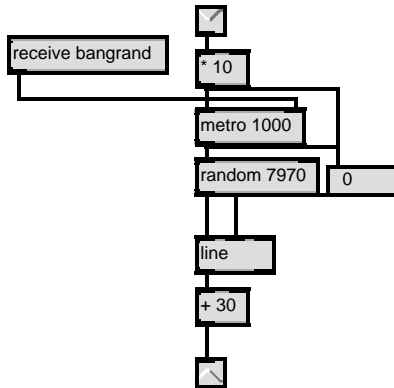

ranregsm2

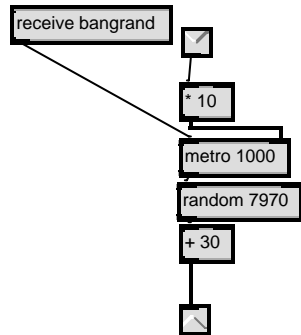

ranregab2

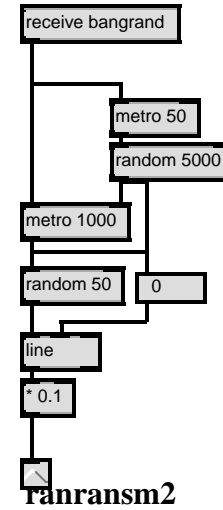

ranransm2

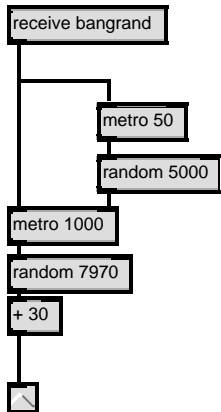

ranranab2

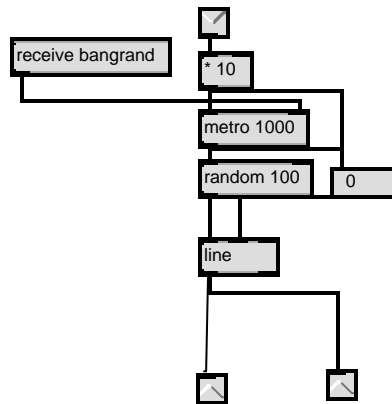

ranregsm3

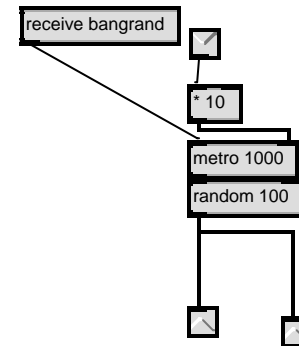

ranregab3

Filter-Delay.pat subpatches continued

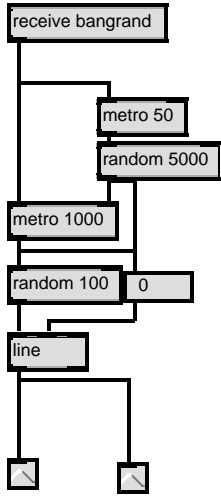

ranransm3

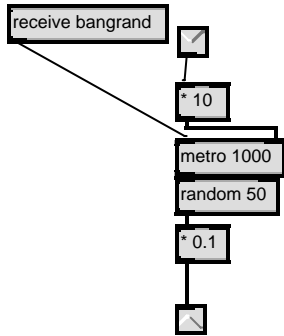

ranregab4

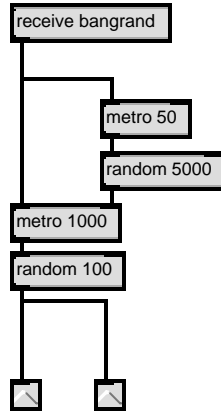

ranranab3

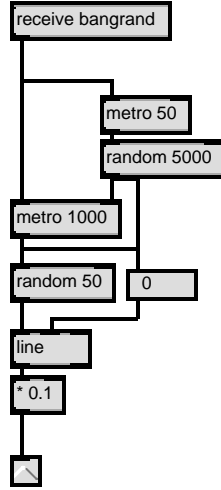

ranransm4

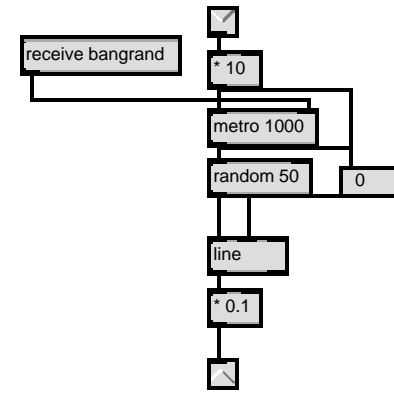

ranregsm4

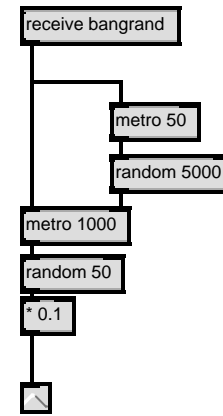

ranranab4

Filter-Delay.pat subpatches continued

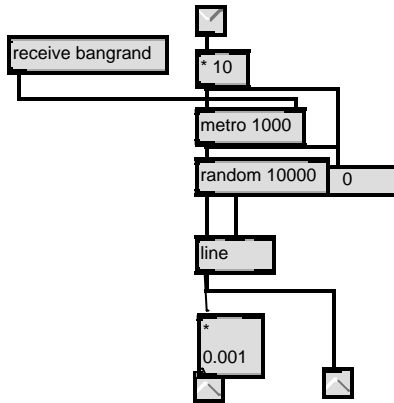

ranregsm5

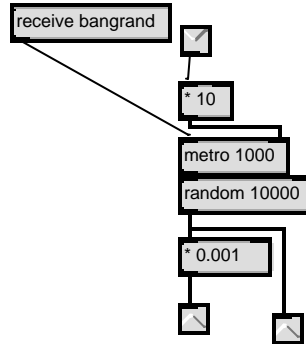

ranregab5

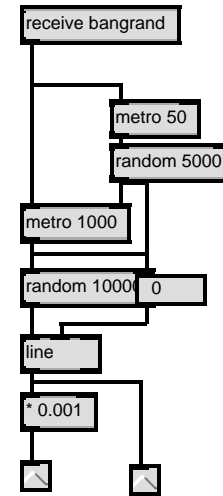

ranransm5

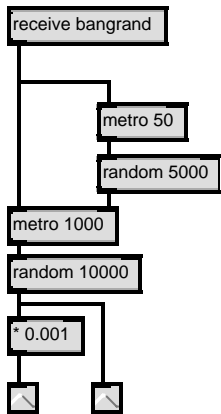

ranranab5

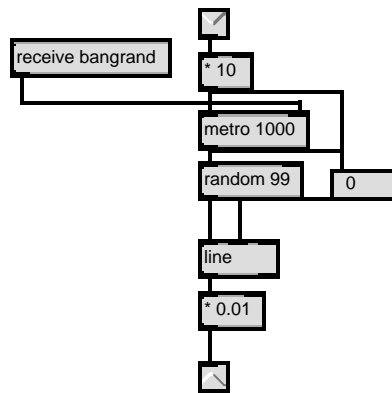

ranregsm6

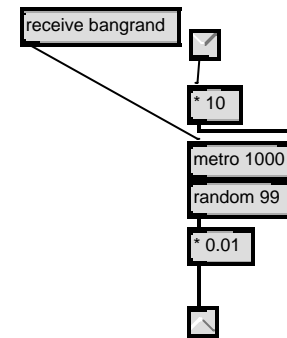

ranregab6

Filter-Delay.pat subpatches continued

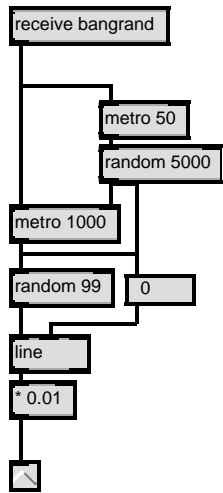

ranransm6

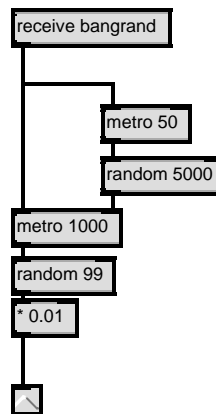

ranranab6

Ring-Filter.pat background

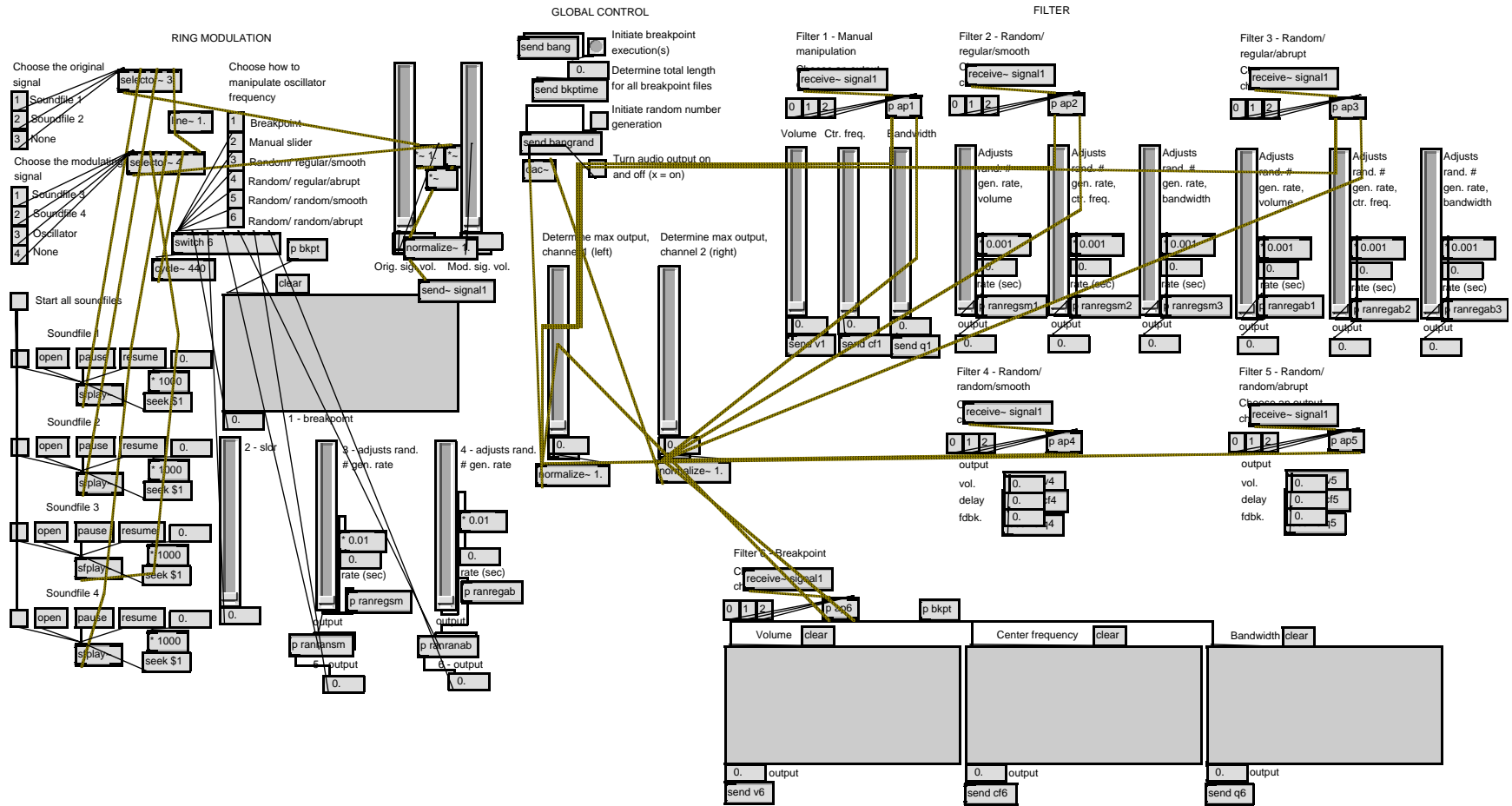

Ring-Filter.pat subpatches

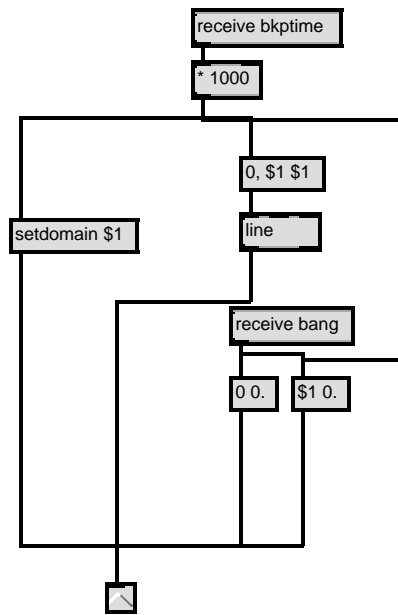

bkpt

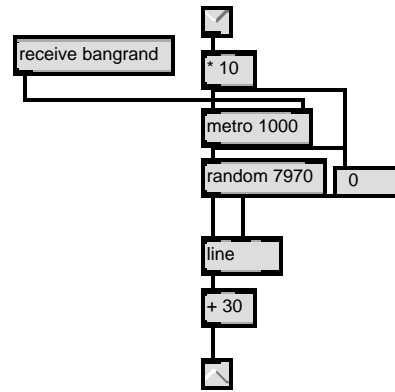

ranregsm

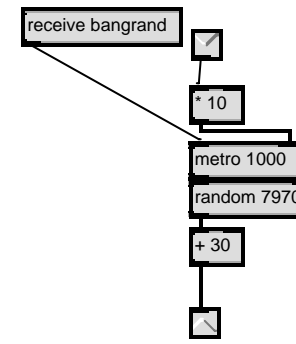

ranregab

Ring-Fitler.pat subpatches continued

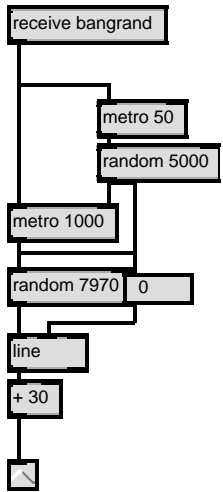

ranransm

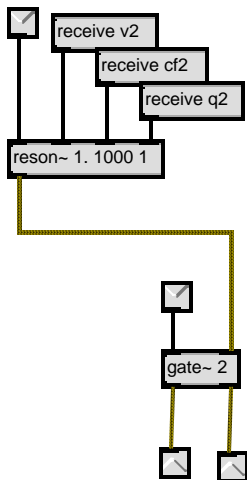

ap2

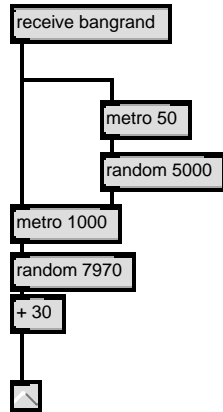

ranranab

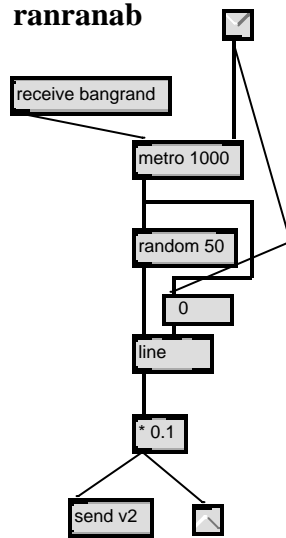

ranregsm1

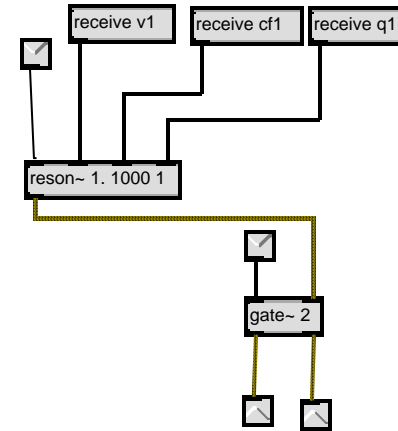

ap1

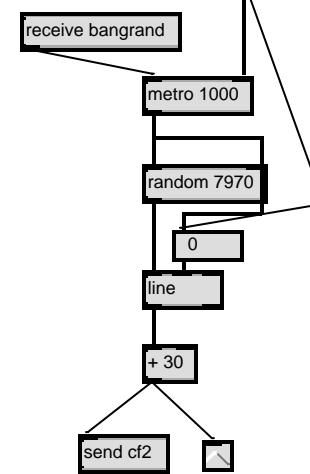

ranregsm2

Ring-Filter.pat subpatches continued

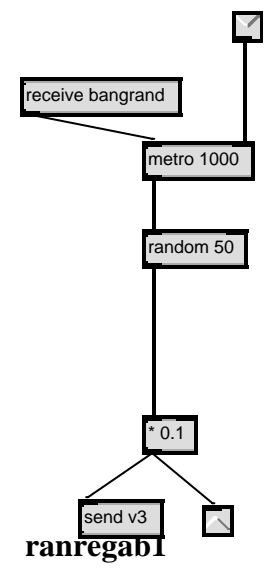
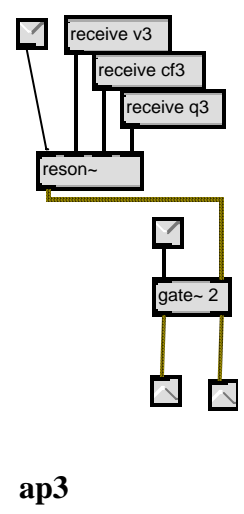
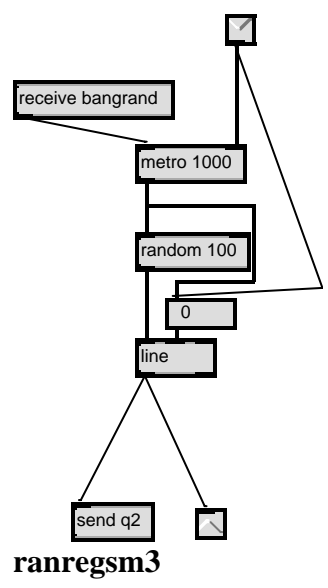

Ring-Filter.pat subpatches continued

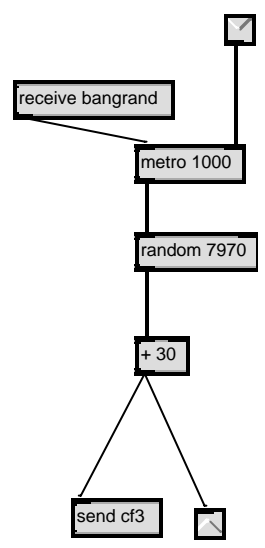

ranregab2

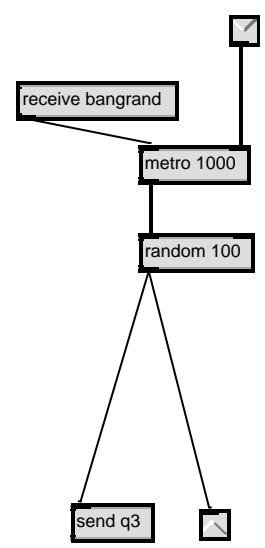

ranregab3

Ring-Filter.pat subpatches continued

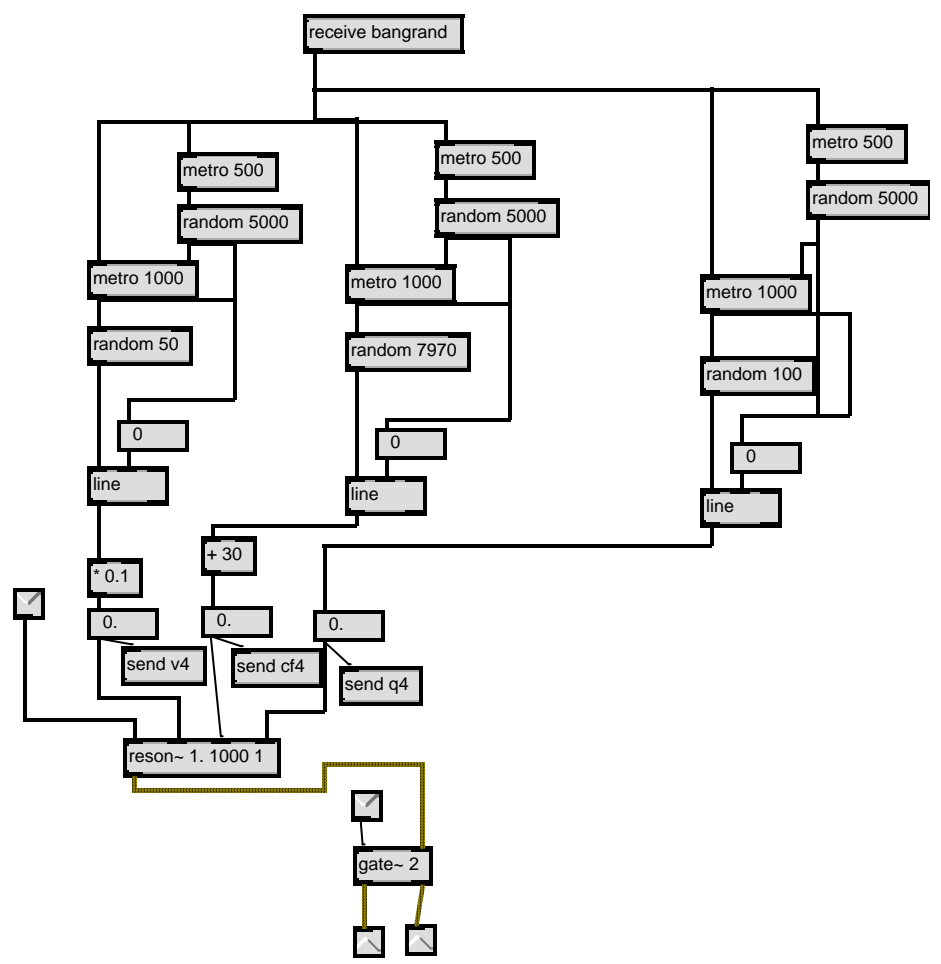

ap4

Ring-Filter.pat subpatches continued

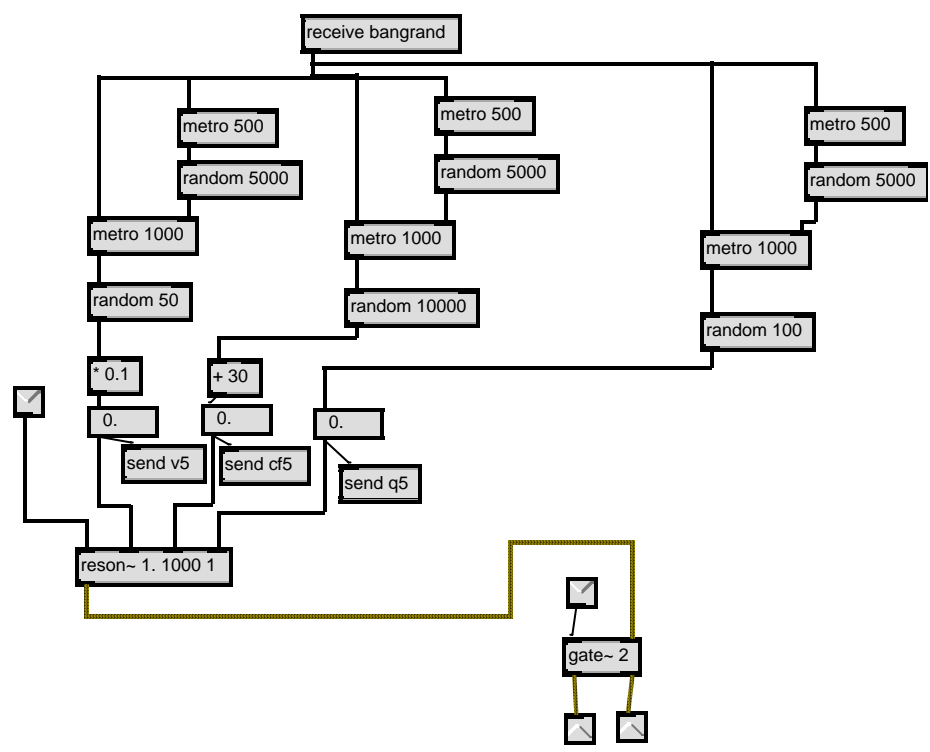

ap5

Ring-Filter.pat subpatches continued

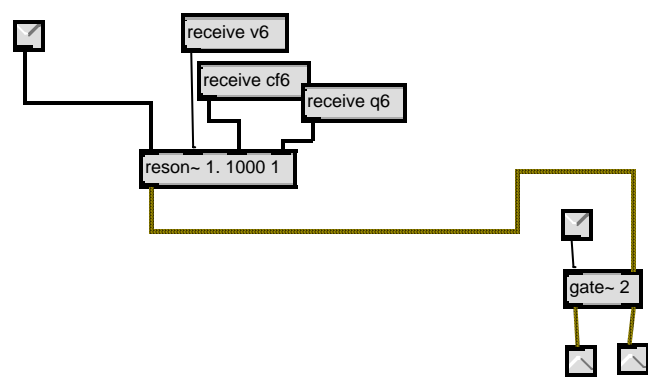

ap6

Ring-Delay.pat subpatches

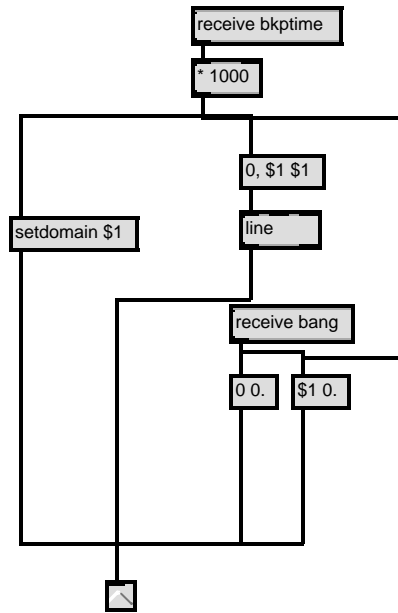

bkpt

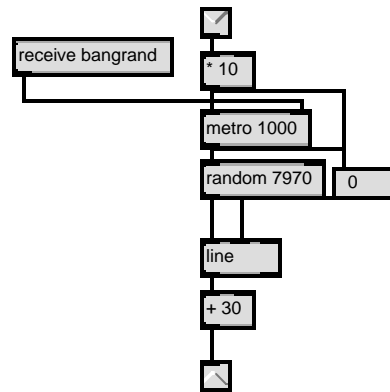

ranregsm

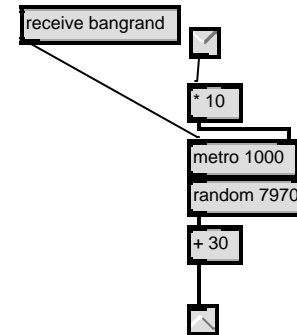

ranregab

Ring-Delay.pat subpatches continued

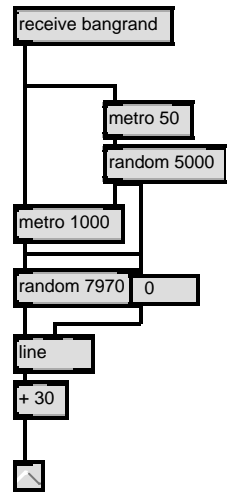

ranransm

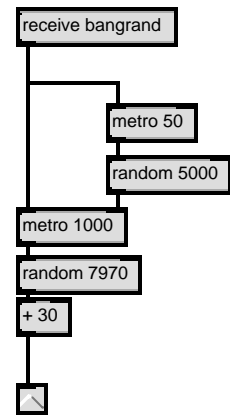

ranranab

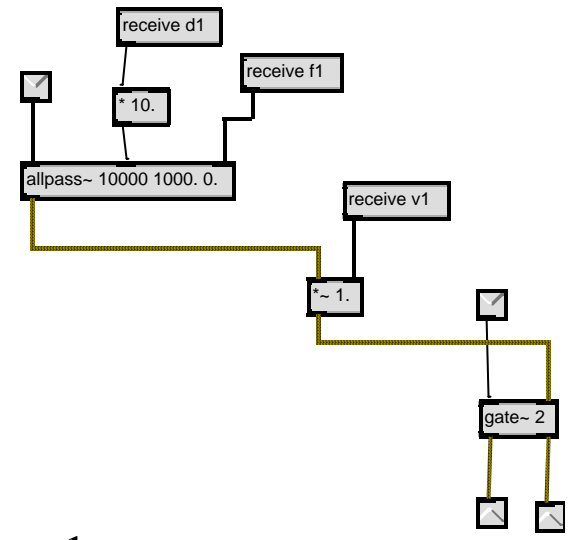

ap1

Ring-Delay.pat subpatches continued

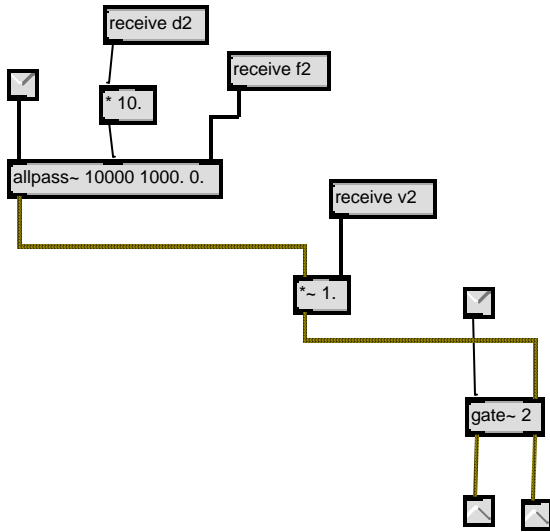

ap2

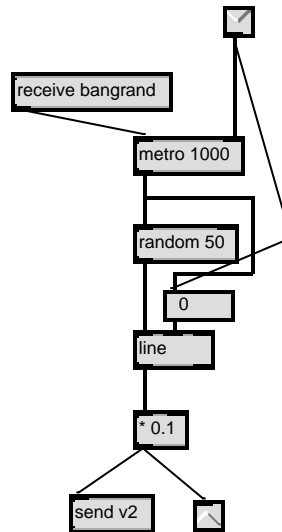

ranregsm1

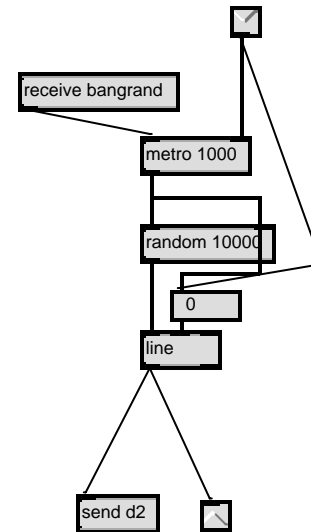

ranregsm2

Ring-Delay.pat subpatches continued

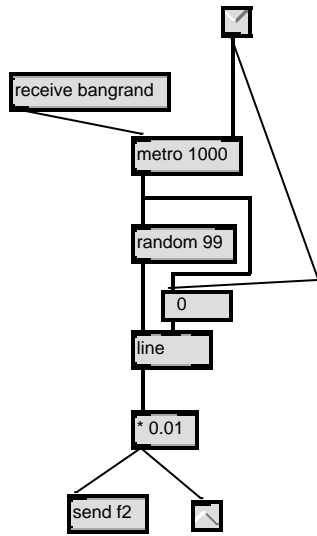

ranregsm3

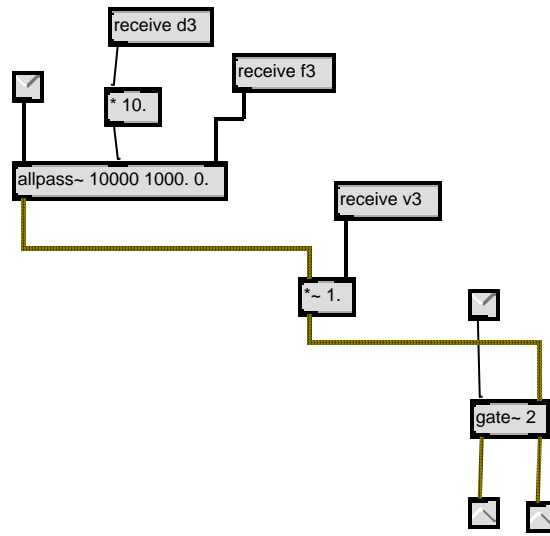

ap3

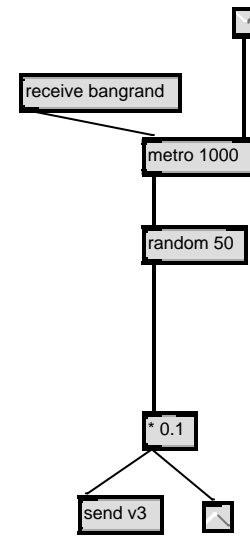

ranregab1

Ring-Delay.pat subpatches continued

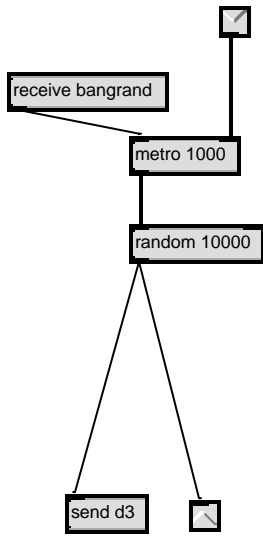

ranregab2

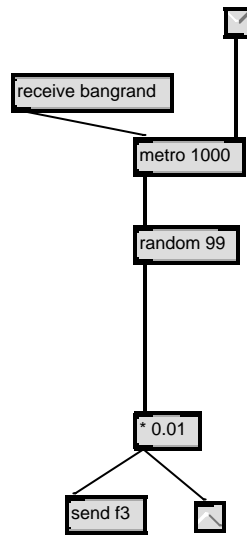

ranregab3

Ring-Delay.pat subpatches continued

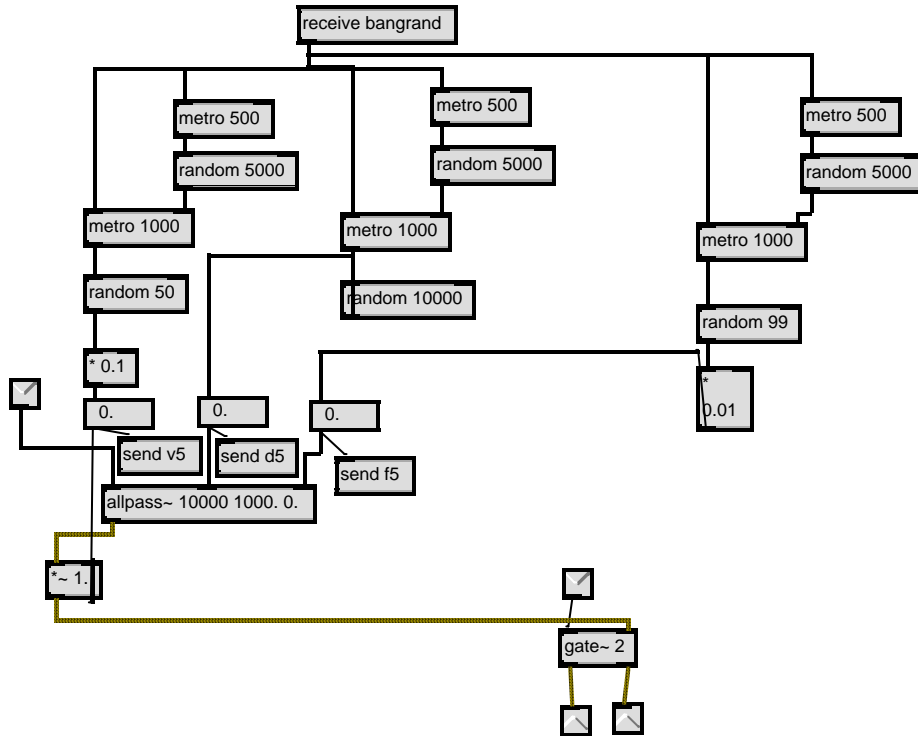

ap5

Ring-Delay.pat subpatches continued

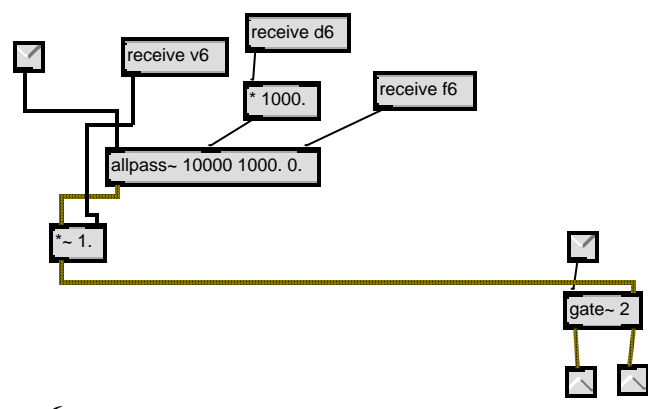

ap6

Ring-Filter-Delay.pat background

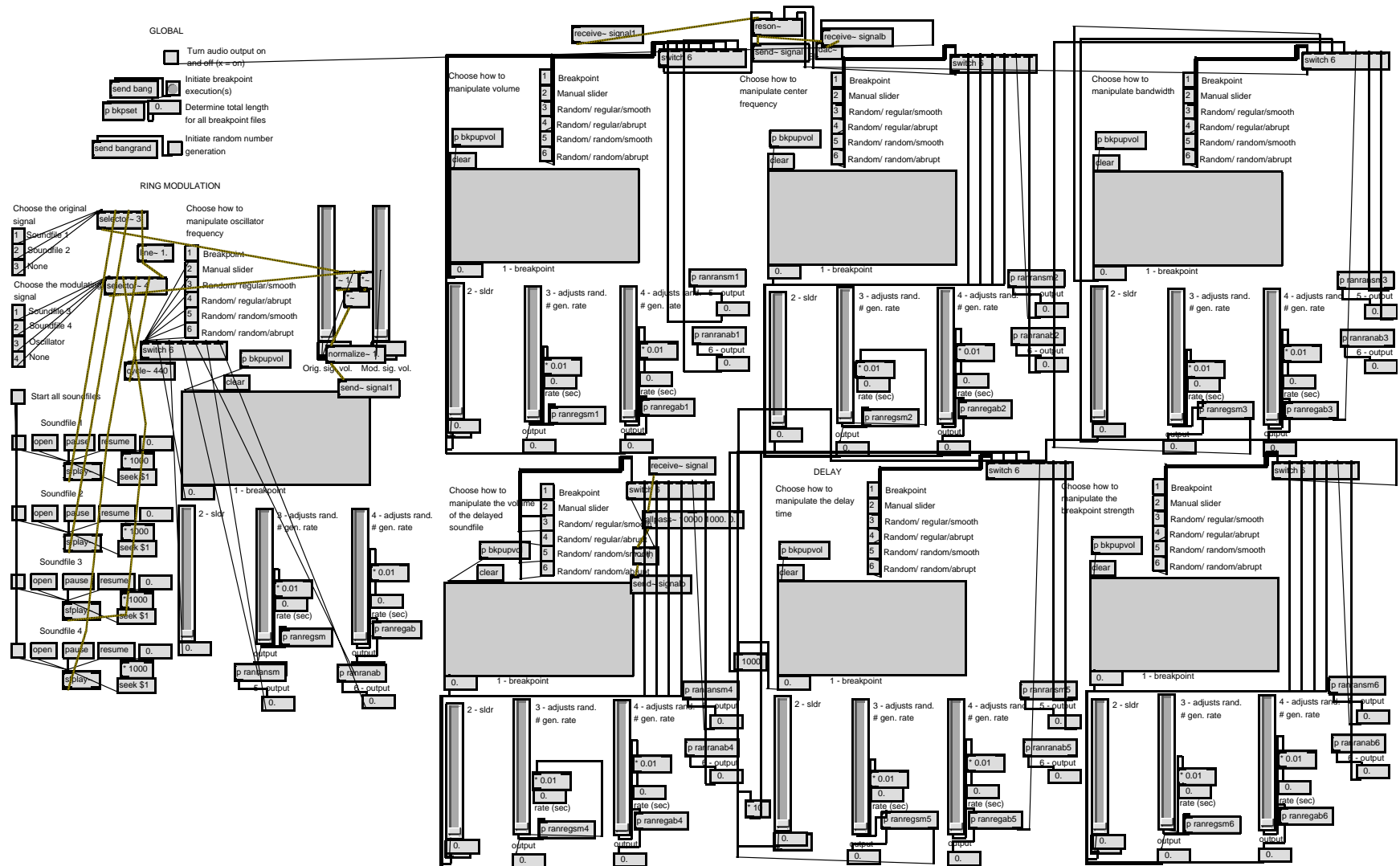

Ring-Filter-Delay.pat subpatches

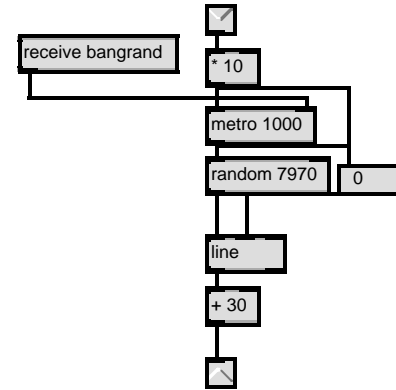
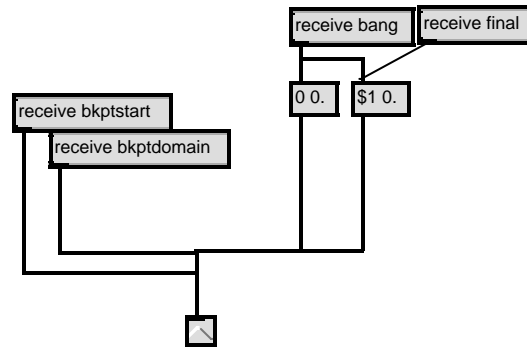
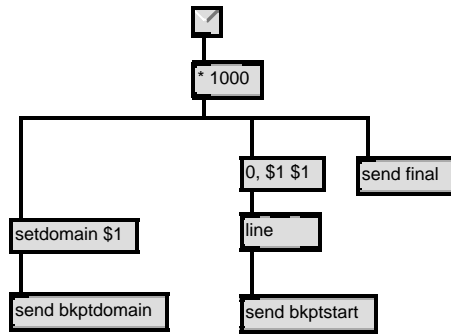

bkpset

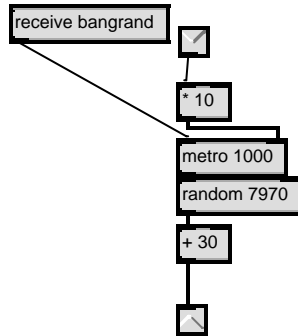

bkpupvol

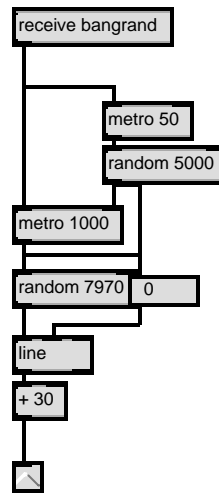

ranregsm

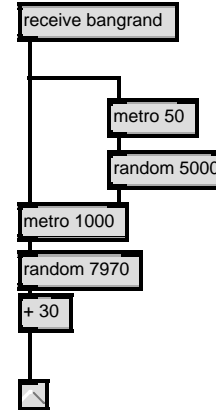

ranregab

ranransm

ranranab

Ring-Filter-Delay.pat subpatches continued

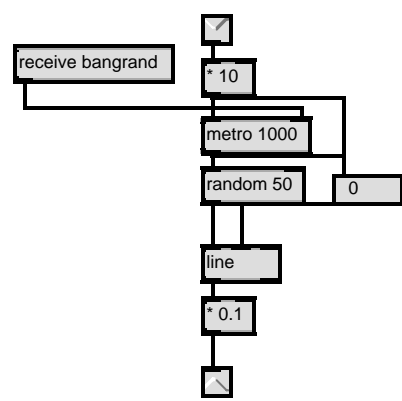

ranregsm1

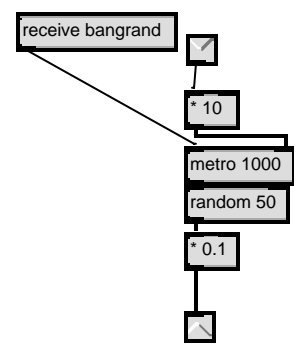

ranregab1

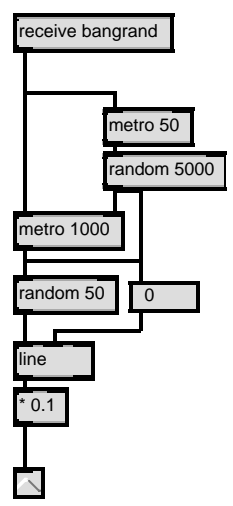

ranransm1

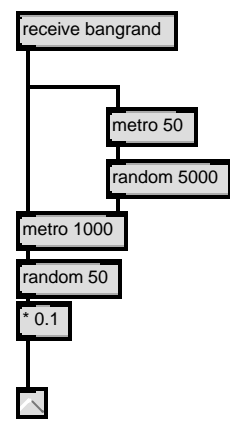

ranranab1

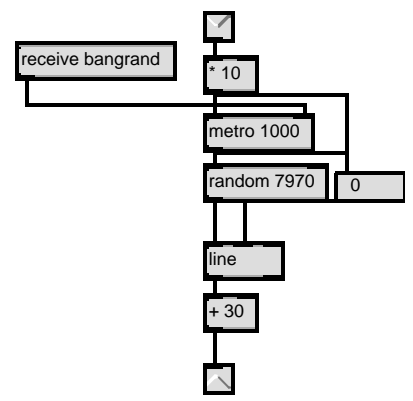

ranregsm2

Ring-Filter-Delay.pat subpatches continued

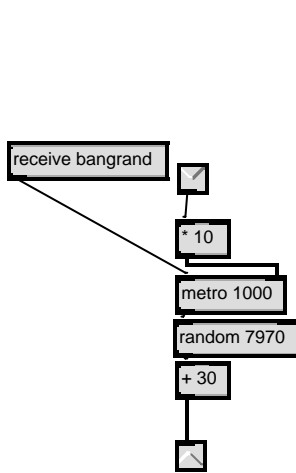

ranregab2

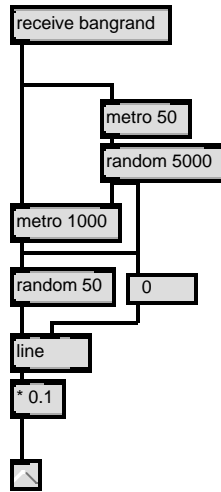

ranransm2

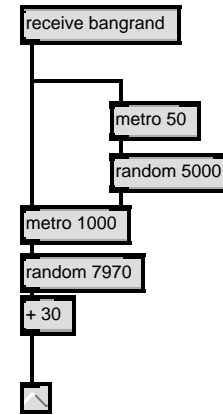

ranranab2

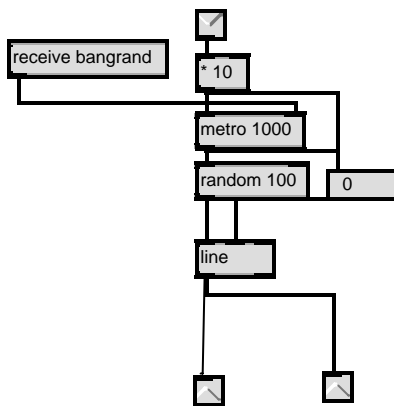

ranregsm3

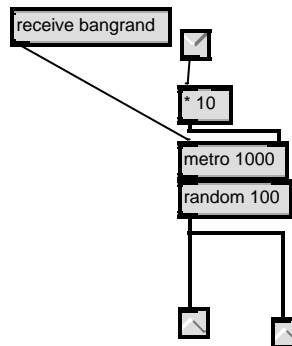

ranregab3

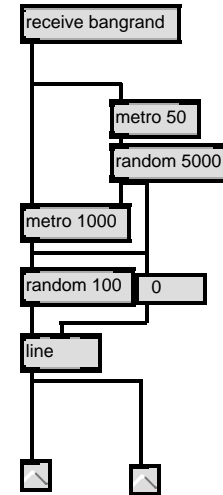

ranransm3

Ring-Filter-Delay.pat subpatches continued

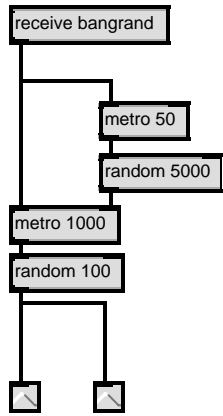

ranranab3

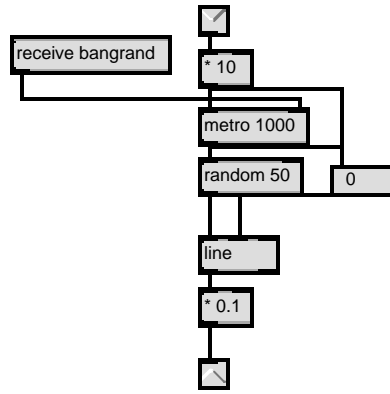

ranregsm4

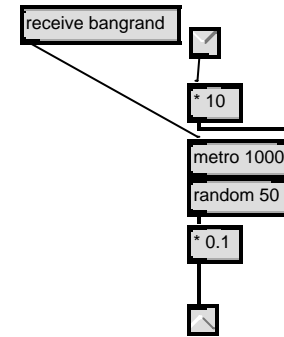

ranregab4

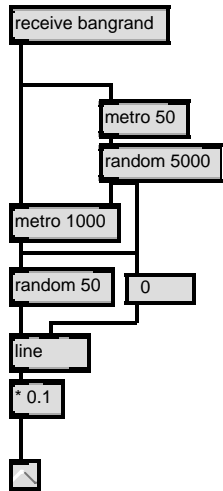

ranransm4

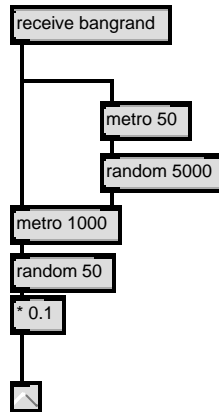

ranranab4

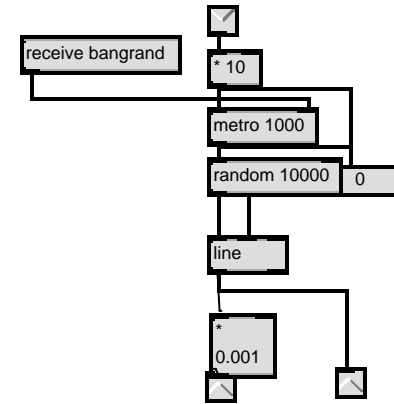

ranregsm5

Ring-Filter-Delay.pat subpatches continued

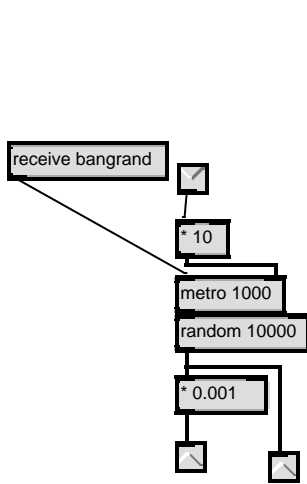

ranregab5

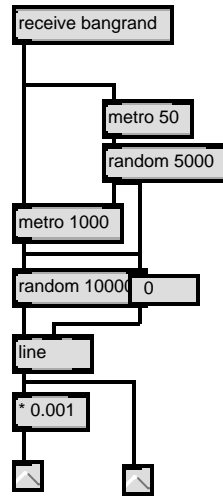

ranransm5

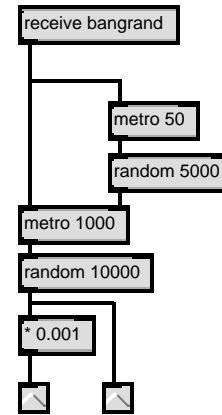

ranranab5

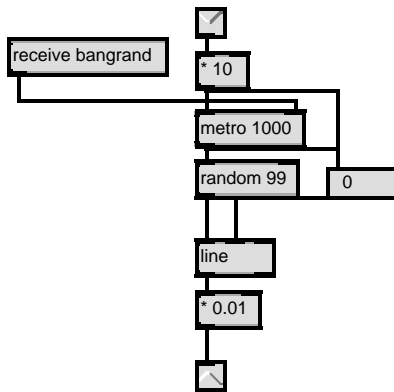

ranregsm6

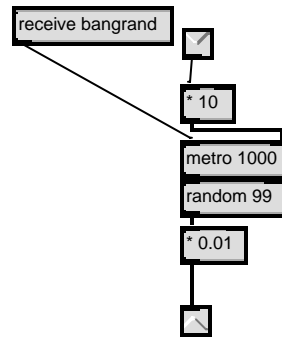

ranregab6

Ring-Filter-Delay.pat subpatches continued

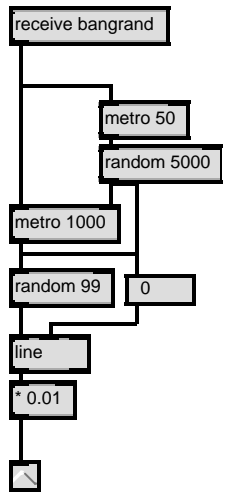

ranransm6

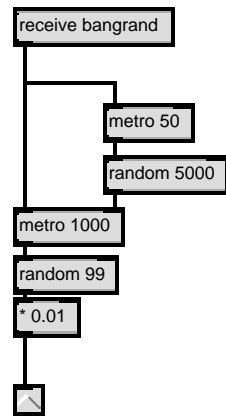

ranranab6