

ABSTRACT

Title of Dissertation: TECHNICAL AND ECONOMIC FEASIBILITY
OF TELEROBOTIC ON-ORBIT
SATELLITE SERVICING

Brook Rowland Sullivan,
Doctor of Philosophy, 2005

Dissertation directed by: Professor David L. Akin
Department of Aerospace Engineering
Space Systems Laboratory
University of Maryland

The aim of this research is to devise an improved method for evaluating the technical and economic feasibility of telerobotic on-orbit satellite servicing scenarios. Past, present, and future telerobotic on-orbit servicing systems and their key capabilities are examined. Previous technical and economic analyses of satellite servicing are reviewed and evaluated. The standard method employed by previous feasibility studies is extended, developing a new servicing decision approach incorporating operational uncertainties (launch, docking, et cetera). Comprehensive databases of satellite characteristics and on-orbit failures are developed to provide input to the expected value evaluation of the servicing versus no-servicing decision. Past satellite failures are reviewed and analyzed, including the economic impact of those satellite failures. Opportunities for spacecraft life extension are also determined. Servicing markets of various types are identified and detailed using the results of the database analysis and the

new, expected-value-based servicing feasibility method. This expected value market assessment provides a standard basis for satellite servicing decision-making for any proposed servicing architecture. Finally, the method is demonstrated by evaluating a proposed small, lightweight servicer providing retirement services for geosynchronous spacecraft. An additional benefit of the method is that it enables parametric analysis of the sensitivity of economic viability to the probability of docking success, thus establishing a threshold for that critical value. While based on a more economically conservative approach, the new method demonstrates the feasibility of the proposed server in the face of operational uncertainties.

TECHNICAL AND ECONOMIC FEASIBILITY
OF TELEROBOTIC ON-ORBIT
SATELLITE SERVICING

by

Brook Rowland Sullivan

Dissertation submitted to the Faculty of the Graduate School of the
University of Maryland, College Park in partial fulfillment
of the requirements for the degree of
Doctor of Philosophy
2005

Advisory Committee:

Professor David L. Akin, Chairman/Advisor
Professor Mark Austin
Dr. Craig R. Carignan
Professor Roberto Celi
Professor M. Robert Sanner

© Copyright by

University of Maryland Space Systems Laboratory

Brook Rowland Sullivan

2005

PREFACE

“Looks like your vehicle is out of gas. Would you like to buy a new one?”

There has got to be a better way.

DEDICATION

To Mom & Dad
and Eve,

This dissertation is built upon
your unwavering support,
unflagging encouragement,
and sustaining love.

And to Debbie, Sissy, and David,
Gone too soon. Dearly missed.

ACKNOWLEDGEMENTS

Many people contributed to the existence of this dissertation. Firstly, I owe thanks to Dr. Dave Akin and to David Lavery for the opportunity to work at one of the most interesting places on the planet. Thanks as well to my very patient committee members.

My time at the lab started with a suggestion from Joe Parrish - thanks, I think. I also received all manner of assistance and encouragement from my lab-mates (Craig, Russ, Maki, JM, Lisa, Robs, Steves, Corde, Debbie, Mikes, and Adam) and office-mates (Evie, Sarah, and Joe). Thanks also to Kiwi, Glen, Claudia, Julianne, Brian, Phil, and Gardell for inspiration along the way. Particular thanks to Jeff Smithanik and Jeff Braden for spending a few weeks asking, "What if?"

Late in the research process, Dr. Owen Brown, Dr. Albert Bosse, and Dr. Gordon Roesler asked some very good questions that led in useful directions. Thanks.

And a special thanks to Dr. Mary Bowden for keeping this on the administrative rails right up to the very end.

The final production of this document was ably abetted by Sarah Hall, Suneel Sheikh, Stephen Roderick, and my excellent wife, Eve.

TABLE OF CONTENTS

List of Tables	xii
List of Figures	xvii
List of Abbreviations	xxiii
1 Introduction	1
1.1 Motivations	1
1.1.1 On-Orbit Failures	2
1.1.2 Spacecraft Life Extension	3
1.1.3 Other Servicing Opportunities	4
1.1.4 Advancing Robotic Capabilities	4
1.1.5 New Launch Alternatives	6
1.2 Dissertation Overview	7
1.3 Contributions	8
2 Background	10
2.1 The Satellite Servicing Problem	10
2.1.1 Servicing Failures	13
2.1.2 Spacecraft Lifetime Extension	15
2.1.3 Other Services	16
2.2 A Brief History Of On-Orbit Servicing	17

2.2.1	Space Shuttle Based Satellite Servicing Missions	17
2.2.2	Satellite Self Rescues	20
2.2.3	Space Shuttle Based Servicing Technology Demonstrations	20
2.2.4	Other On-Orbit Servicing Technology Demonstrations	22
2.3	Future Servicing Technology Demonstrations	23
2.3.1	Future Servicing Technology Flight Missions	23
2.3.2	Dexterous Robotic Servicing Research Programs	27
2.4	Robotic Serviceability Of Satellites	28
2.4.1	Target Satellites	28
2.4.2	Servicers	29
3	Previous Satellite Servicing Economic Models	35
3.1	1981 - Manger	35
3.2	1981 - Vandekerckhove	41
3.3	1985 - Vandekerckhove	43
3.4	1989 - Yasaka	46
3.5	1992 - The INTEC Study	48
3.6	1994 - Newman	50
3.7	1996 - Hibbard	54
3.8	1998 - Davinic	56
3.9	1999 - Leisman	57
3.10	2001 - Lamassoure	59
3.11	2002 - McVey	59
3.12	2004 - Walton	60
3.13	Other Economic Studies	61
3.14	Cost Estimation Methods	62
3.15	Evaluation Of Previous Studies	64

3.15.1	Operational Uncertainty	64
3.15.2	Comprehensive Market Assessment	65
3.15.3	Decoupling Market Assessment From Servicer Design	65
4	A New Method To Evaluate Servicing Feasibility	66
4.1	Previous Servicing Decision Method	66
4.2	Expected Value Method	67
4.3	New Servicing Decision Method	69
4.4	Satellite Information Required For New Method	70
5	Database Development	71
5.1	Spacecraft Information Database	72
5.1.1	Spacecraft Identification Scheme	72
5.1.2	Sources	73
5.1.3	Fields	74
5.2	Database of On-Orbit Spacecraft Failures	79
5.2.1	Failures Identification Scheme	79
5.2.2	Sources	80
5.2.3	Fields	80
6	Satellite Trends	82
6.1	Commercial Geosynchronous Communications Satellites	82
6.2	Transponders Per Commercial Geosynchronous Communications Satellite	84
6.3	Total Commercial Geosynchronous Communications Satellite Transponders	85
6.4	Bandwidth Per Transponder	86
6.5	Stabilization Of Commercial Geosynchronous Communication Satellites	88

6.6	Geosynchronous Communication Satellite Buses	90
6.7	Commercial Geosynchronous Communications Satellite Design Life	92
6.8	Bandwidth-Design Life Trends	93
6.9	Failure Rate	96
7	On-Orbit Servicing Opportunities	99
7.1	Launches And Payloads	99
7.2	Economic Impact Of On-Orbit Satellite Failures	102
7.3	Spacecraft Failure Servicing Opportunities	105
7.3.1	Wrong Orbit	105
7.3.2	Deployment Problems	112
7.3.3	Component Failures	112
7.3.4	Fuel Depletion	116
7.3.5	Other Failures	116
7.3.6	Spacecraft Family Anomalies	119
7.3.7	Failed Spacecraft Relocation	122
7.3.8	Observations Concerning Serviceable Failures	126
7.4	Spacecraft Lifetime Extension	129
7.4.1	Relocation	129
7.4.2	Refueling	137
7.4.3	Consumables Replenishment	140
7.4.4	Preventative Maintenance	141
7.4.5	Spacecraft Upgrade	142
7.4.6	Optical Surface Maintenance	142
7.5	Other Services	144
7.5.1	Inspection	144
7.5.2	Debris And Failed Spacecraft Relocation	145

7.6	Summary Of Opportunities	149
8	Expected Value Of Servicing Market Segments	150
8.1	Chance Node Probabilities	152
8.1.1	Launch Outcomes	152
8.1.2	Orbital Transfer Outcomes	154
8.1.3	Graveyard Transfer Outcomes	154
8.1.4	Deployment Outcomes	155
8.1.5	Docking Outcomes	156
8.1.6	Undocking Outcomes	156
8.1.7	Refueling Outcomes	157
8.1.8	Dexterous Repair Outcomes	158
8.2	Servicing Mission Expected Values	159
8.2.1	Retirement Maneuver	159
8.2.2	LEO to GEO Transfer	167
8.2.3	Relocate In GEO	171
8.2.4	Refuel	174
8.2.5	ORU-Like Replacement	177
8.2.6	General Repair	180
8.2.7	Deployment Assistance	181
8.2.8	Deployment Monitoring	184
8.2.9	Remove Inactive	187
8.2.10	Health Monitoring	190
8.3	Summary Of Servicing Mission Expected Values	190
8.4	Robotic Complexity	192
9	Demonstration Of The New Method	196
9.1	Servicer Description	196

9.2	Servicer Operations Concept	199
9.3	Application Of The New Feasibility Methodology	204
10	Conclusion	215
10.1	Results	215
10.1.1	Assessment Of Previous Studies	216
10.1.2	Identification Of Servicing Opportunities	216
10.1.3	Determination Of Expected Value Outcomes And Probabilities	219
10.1.4	Assessment Of Servicing Markets	219
10.1.5	Evaluation Of A Proposed Servicer	219
10.1.6	Parametric Analysis Of The Required Docking Success Rate .	220
10.2	Contributions	220
10.2.1	Market Segment Selection	220
10.2.2	Operational Uncertainties	221
10.2.3	On-Orbit Failures By Type	221
10.2.4	Overall Servicing Market Characterization	221
10.2.5	Feasibility Demonstration	222
10.2.6	Determination Of Technology Performance Requirements . . .	222
10.3	Recommendations	222
10.4	Final Summary	223
A	Satellite Trends	224
A.1	Satellites By Market	224
A.2	Satellites By Orbit	230
A.3	Geosynchronous Satellite Lifetimes	235
B	Geosynchronous Communications Satellite Revenues	238
C	On-Orbit Satellite Failures	240

D	Spacecraft Self-Rescues	246
E	Satellite Orbital Information	253
E.1	NORAD Two-Line Element Set Format	253
E.2	Orbital Element Analysis Programs	255
E.2.1	ParseOIGdata	255
E.2.2	GEOLongs	256
E.2.3	MakePlotSpec	257
E.2.4	PlotMania	257
F	Launch Costs To GEO	261
G	Inflation Rates	262
H	Database Sample Record	263
	References	270

LIST OF TABLES

2.1	Shuttle Based Satellite Servicing Missions	18
2.2	Shuttle Based EVA Satellite Servicing Missions	19
2.3	GEO Spacecraft Which Utilized Onboard Fuel To Overcome Launch Anomalies	20
2.4	Shuttle Based Robotic Servicing Demonstrations	21
2.5	On-Orbit Robotic Servicing Technology Demonstrations	22
2.6	Upcoming Robotic Servicing Demonstration Missions	24
2.7	Ongoing Robotic Servicing Research Projects	27
2.8	ORS - Shuttle Based Refueling Demonstration	33
2.9	ORS - Shuttle Based Refueling Demonstration	34
3.1	Parameters for Manger Model	37
3.2	Parameters for the 1981 Vandekerckhove Model	42
3.3	Parameters for the 1985 Vandekerckhove Models	45
3.4	Yasaka Model Parameters	47
3.5	Net Present Value Variables	48
3.6	INTEC Satellite Replacement Scenario	49
3.7	INTEC Satellite Repair Scenario	49
3.8	Newman Servicing Parameters	52
3.9	Ranger TFX Images	53
3.10	Hibbard Parameters From Equation 3.25	55

3.11 Davinic Equation Parameters	56
3.12 Leisman Parameters	58
3.13 McVey Study (Black-Scholes) Equation Parameters	60
3.14 Walton Equation Parameters	61
3.15 Cost Estimation Models	63
4.1 Parameters From Equation 4.1	67
4.2 Expected Value Equation Parameters	68
5.1 Databases	72
5.2 Identification Scheme For Successful Launches	73
5.3 Identification Scheme For Missions That Failed To Orbit	73
5.4 Satellite Database Sources	74
5.5 Satellite Database Fields - ID Related Fields	75
5.6 Satellite Database Fields - Mission Related Fields	75
5.7 Satellite Database Fields - Launch Related Fields	76
5.8 Satellite Database Fields - Spacecraft Related Fields	76
5.9 Satellite Database Fields - Lifetime Related Fields	76
5.10 Satellite Database Fields - Financial Related Fields	77
5.11 Satellite Database Fields - Orbit Related Fields	77
5.12 Satellite Database Fields - GEO Related Fields	77
5.13 Satellite Database Fields - GEO Communications Related Fields	78
5.14 Identification Scheme For On-Orbit Failure Events	79
5.15 On-Orbit Failures Database Sources	80
5.16 Failures Database Fields	81
7.1 Launches And Launch Failures	101
7.2 Payloads Of Interest	101
7.3 Economic Impacts Of GEO Wrong Orbit Failures	108

7.4	Spacecraft Suffering Deployment Anomalies	113
7.5	On-Orbit Fuel Depletion Anomalies (1994 to 2003)	117
7.6	BSS-601 Spacecraft Susceptible To SCP Failure	120
7.7	BSS-702 Spacecraft Susceptible To Early Solar Array Degradation	122
7.8	FS-1300 Spacecraft Susceptible To Early Solar Array Degradation	123
7.9	Serviceable Failures By Orbit (1984 To 2003)	126
7.10	Failures By Required Service Type	128
7.11	Iridium Fuel Budget	139
7.12	Objects Which Pass Within 1 km Of GEO	146
7.13	Candidate Servicing Missions	149
8.1	Chance Nodes	152
8.2	Expected Value Probabilities - GEO Satellite Delivery To Orbit	153
8.3	Expected Value Probabilities - Orbital Transfer	154
8.4	Expected Value Probabilities - Graveyard Transfer	155
8.5	Expected Value Probabilities - Deploy	156
8.6	Expected Value Probabilities - Docking	156
8.7	Expected Value Probabilities - Undocking	157
8.8	Expected Value Probabilities - Refuel	158
8.9	Expected Value Probabilities - Dexterous Repair	159
8.10	Retirement Maneuver Expected Value Parameters	163
8.11	GTO Relocation Maneuver Expected Value Parameters	169
8.12	Docking And Undocking Parameter Sensitivity	170
8.13	Relocation In GEO Expected Value Parameters	173
8.14	Refueling Expected Value Parameters	176
8.15	ORU-Like Replacement Expected Value Parameters	179
8.16	Deployment Assistance Expected Value Parameters	183

8.17	Refueling Expected Value Parameters	186
8.18	Refueling Expected Value Parameters	189
8.19	Expected Value Break-Even Servicing Fees	191
8.20	Minimum Annual Servicing Market	192
8.21	Robotic Complexity By Mission	193
9.1	Mini-Class Servicer Mass Breakout	198
9.2	GasPod Mass Breakout	198
9.3	Description Of Columns In Fuel Load Accounting	200
9.4	Mini Operations Fuel Accounting	203
9.5	Mini Program Costs	204
9.6	Mini Scenario, Expected Value Accounting	212
9.7	Mini Scenario, Expected Value Accounting, Continued	213
9.8	Mini Scenario By Docking Failure Rate	214
B.1	Satellite Revenues For The Top 10 Satellite Operators For 2001 [33] .	238
B.2	Satellite Revenues For The Top 10 Satellite Operators For 2002 [33] .	239
B.3	Satellite Revenues For The Top 10 Satellite Operators For 2003 [33] .	239
B.4	Average Geosynchronous Communications Satellite Revenues	239
C.1	Insurance Payouts For On-Orbit Satellite Failures	242
C.2	Estimated Losses For Uninsured On-Orbit Satellite Failures	243
C.3	Additional Significant On-Orbit Satellite Failures	245
D.1	GEO Bound Spacecraft That Recovered From Incorrect Initial Orbits	247
E.1	NORAD Two-Line Element Set Format [64], [26] - Line 1	254
E.2	NORAD Two-Line Element Set Format [64], [26] - Line 2	254
E.3	Orbital Element Manipulating Programs	255

F.1	GEO Cost Per kg	261
G.1	Annual Inflation Rate [9]	262
H.1	Satellite Database Sample Record	268
H.2	On-Orbit Failure Database Sample Record	269

LIST OF FIGURES

1.1	Space Robot Matrix [41]	6
2.1	On-Orbit Servicing Robot Concept From 1969 [65]	12
2.2	On-Orbit Servicing Robot Ground Demonstration, 2004 (RTSX) [34]	12
2.3	The Life Paths Of An Unserviced Satellite	14
2.4	Satellite Servicing Opportunities	15
2.5	Ranger TSX Prepares To Dock With A Simulated Spacecraft [34] . .	30
2.6	ESA Crown Locking Mechanism [58]	30
2.7	Apparatus for Attaching Two Spacecraft Under Remote Control [86], [87]	31
3.1	Manger Model: Effects Of Basic Satellite Cost (Adapted from [72]) . .	39
3.2	Manger Model: Relative Effects Of Basic Satellite Cost (Adapted from [72])	40
3.3	Value Of Servicing Architecture Versus Cost (Adapted from [69]) . .	58
4.1	Expected Value Method	68
4.2	Expected Value Diagram For Servicing	69
6.1	Active Commercial GEO Spacecraft	83
6.2	Average Transponder Count On Active Geostationary Commercial Satel- lites	84
6.3	GEO Spacecraft Commercial Transponder Capacity	85

6.4	C-band Transponder Bandwidth By Year, 1994 To 2003	86
6.5	Ku-band Transponder Bandwidth By Year, 1994 To 2003	87
6.6	Stabilization Method Of Commercial Geosynchronous Communication Satellites, 1984 To 2003	89
6.7	Geosynchronous Communication Satellite Buses, Launched From 1984 To 2003	90
6.8	Active Geosynchronous Communication Satellites By Spacecraft Bus, 1984 To 2003	91
6.9	Average Design Life Of Active Geostationary Commercial Satellites .	92
6.10	Total Bandwidth-Design Life Launched, 1984 to 2003	93
6.11	Bandwidth-Design Life Per Satellite, 1984 To 2003	94
6.12	Five Year Moving Average, Bandwidth-Design Life Per Satellite . . .	95
6.13	Typical Failure-Rate Curve Relationship (adapted from [43])	96
6.14	Failure Rate For All Satellites Launched From 1984 to 2003	97
6.15	Failure Rate Over Design Life For All Satellites Launched From 1984 to 2003	98
7.1	Launch Attempts And Launch Failures	100
7.2	Insurance Claims For On-Orbit Satellite Failures	102
7.3	Estimated Value Of Uninsured On-Orbit Satellite Failures	103
7.4	Value Of Insured And Uninsured On-Orbit Satellite Failures	104
7.5	Results Of Launch Attempts To Geosynchronous Orbit	106
7.6	Results Of Launch Anomalies For Geosynchronous Payloads	107
7.7	GEO FTO And WO Five Year Moving Averages	109
7.8	GEO FTO And WO Five Year Moving Averages	110
7.9	Koreasat 1 Altitude History	111
7.10	ORU-Like Failures In GEO	114

7.11	ORU-Like Failures In LEO	115
7.12	Additional Servicing Opportunities	118
7.13	SCP Vulnerable BSS-601s Remaining In Service	121
7.14	Perigees And Apogees For Active And Inactive GPS Satellites	124
7.15	Perigees And Apogees For Active And Inactive Iridium Satellites	125
7.16	Total Investments And Active Satellites By Orbit - 2003	127
7.17	Annual GEO Relocations	132
7.18	Annual GEO Relocations Degrees	133
7.19	Geosynchronous Communication Spacecraft Retirements From 1984 To 2003	135
7.20	Geosynchronous Communication Spacecraft To Retire From 2004 To 2015	136
7.21	Commercial Geosynchronous Communication Spacecraft Operating Be- yond Design Life In 2004	137
7.22	Civilian And Military Geosynchronous Communication Spacecraft Op- erating Beyond Design Life In 2004	138
7.23	Years Actual Life Exceeded Design Life For Retired Geosynchronous Communications Satellites Launched Since 1980	140
7.24	Ratio Of Active Life Beyond Design Life To Design Life For Retired Geosynchronous Communications Satellites Launched Since 1980	141
7.25	Actual And Design Life For Retired Geosynchronous Communications Satellites Launched Since 1980 That Functioned Inclined While Active	142
7.26	Objects Which Pass Within 5 km Of GEO	147
7.27	Objects Which Pass Within 50 km Of GEO	147
7.28	Objects Which Pass Within 500 km Of GEO	148
7.29	Annual New Inactive Objects Passing Within 200 km Of GEO	148

8.1	Expected Value Diagram For Retirement Mission	160
8.2	Expected Value Diagram For Retirement Mission	161
8.3	<i>vSvcFee</i> Sensitivity To Changes In <i>pDockFail</i>	164
8.4	<i>vSvcFee</i> Sensitivity To Changes In <i>pDockFail</i> (No Hazard Penalty)	166
8.5	Expected Value Diagram For GTO Relocation Mission	168
8.6	Expected Value Diagram For Relocation Mission	172
8.7	Expected Value Diagram For Refueling Mission	174
8.8	Expected Value Diagram For ORU-Like Replacement Mission	177
8.9	Expected Value Diagram For General Repair Mission	180
8.10	Expected Value Diagram For Deployment Assistance Mission	181
8.11	Expected Value Diagram For Deployment Monitoring Mission	185
8.12	Expected Value Diagram For Removal Of Inactive Mission	187
9.1	MODSS Servicer [40]	197
9.2	Mini-Class First Fuel Load	201
9.3	Mini-Class n^{th} Fuel Load	202
9.4	Expected Values By Target Serviced, First Mini	206
9.5	Expected Values By Target Serviced, First Mini, First GasPod Added	207
9.6	Expected Values Versus Costs For First Mini And First GasPod Scenario	208
9.7	Expected Values By Target Serviced, n^{th} Mini, n^{th} GasPod Added	209
9.8	Expected Values Versus Costs For n^{th} Mini And n^{th} GasPod Scenario	210
9.9	Expected Values By Target Serviced, n^{th} Mini, n^{th} GasPod Added, <i>pDockFail</i> is 10%	211
A.1	Payloads By Market	225
A.2	Military Payloads By Country	225
A.3	Russian Military Payloads By Orbit	226
A.4	United States Military Payloads By Orbit	226

A.5	Military Payloads By Orbit	227
A.6	Civilian Payloads By Country	227
A.7	Commercial Payloads By Country	228
A.8	Civilian Payloads By Orbit	228
A.9	Commercial Payloads By Orbit	229
A.10	Payloads By Orbit	230
A.11	Commercial Payloads - IGO Breakout	231
A.12	Commercial Payloads Minus IGOs	231
A.13	Orbital Location Of All Spacecraft Near Earth	232
A.14	Orbital Location Of Active Spacecraft In LEO	233
A.15	Orbital Location Of Active Spacecraft In MEO	233
A.16	Orbital Location Of Active Spacecraft In GEO	234
A.17	Orbital Location Of Active Spacecraft In Molniya Orbits	234
A.18	Lifetimes Of Inclined Commercial Communications Satellites Launched Between 1980 And 1985	236
A.19	Lifetimes Of Inclined Commercial Communications Satellites Launched From 1986 Onwards	237
D.1	GSTAR 3 Altitude History	247
D.2	GSTAR 3 Inclination History	248
D.3	UFO 1 Altitude History	248
D.4	UFO 1 Inclination History	249
D.5	Koreasat 1 Altitude History	249
D.6	Koreasat 1 Inclination History	250
D.7	Agila 2 Altitude History	250
D.8	Agila 2 Inclination History	251
D.9	ARTEMIS Altitude History, First 2 Weeks	251

D.10 ARTEMIS Inclination History, First 2 Years	252
E.1 Sample Satellite Geosynchronous Altitude History Plot	258
E.2 Sample Satellite Inclination History Plot	258
E.3 Sample Satellite Geosynchronous Longitude History Plot	259
E.4 Sample Satellite Geosynchronous Longitude History Plot, Active Life	259
E.5 Sample Satellite Period History Plot	260
E.6 Sample Satellite Geosynchronous Period History Plot	260
H.1 Astra 1K [36]	263

LIST OF ABBREVIATIONS

AERCam	Autonomous EVA Robotic Camera
AFIT	Air Force Institute of Techology
AIAA	American Institute of Aeronautics and Astronautics
AKM	Apogee Kick Motor
ASAT	Anti-Satellite
AWST	Aviation Week and Space Technology magazine
BEO	Beyond Earth Orbit
BLS	Bureau of Labor Statistics
BOL	Beginning Of Life
BSS	Boeing Satellite Systems
BW-DL	Bandwidth-Design Life
CER	Cost Estimating Relationship
CIV	Civilian (Satellite Market)
CML	Commercial (Satellite Market)
COSPAR	Committee On Space and Atmospheric Research
DEC	Decayed (from orbit)
DOF	Degrees Of Freedom
EOL	End Of Life
EOR	Earth Orbit
ESA	European Space Agency
ETS	Engineering Test Satellite
EVA	Extra Vehicular Activity
EVR	Extra Vehicular Robotics
FCC	Federal Communications Commission
FOBS	Fractional Orbital Bombardment System
FTO	Failed To Orbit
FTS	Flight Telerobotic Servicer

GEO	Geosynchronous Orbit
GPS	Global Positioning System
GTO	Geosynchronous Transfer Orbit
GSV	Geostationary Servicing Vehicle
HST	Hubble Space Telescope
IGO	Iridium, Globalstar, and OrbComm
INTEC	International Technology Underwriters
ISRO	Indian Space Research Organization
ISS	International Space Station
IUS	Inertial Upper Stage
IVA	Intra Vehicular Activity
JAXA	Japan Aerospace Exploration Agency
JEM	Japanese Experiment Module
JPL	Jet Propulsion Laboratory
JSC	Johnson Space Center
kg	Kilogram
km	Kilometer
LEO	Low Earth Orbit
MAU	Millions of Accounting Units
MBS	Mobile Base System
MEO	Medium Earth Orbit
MFD	Manipulator Flight Demonstration
MHz	Megahertz
MIL	Military (Satellite Market)
MODSS	Miniature Orbital Dexterous Servicing System
MSS	Mobile Servicing System
MMU	Manned Maneuvering Unit
MTBF	Mean Time Between Failures
NAFCOM	NASA / Air Force Costing Model
NASA	National Aeronautics and Space Administration
NASDA	Japanese Space Agency
NBRF	Neutral Buoyancy Research Facility
NBV	Neutral Buoyancy Vehicle
NGO	Non-Governmental Organization

NORAD	North American Air Defense Command
NPV	Net Present Value
NRE	Non-Recurring Engineering
NRL	Naval Research Laboratory
NSSDC	National Space Science Data Center
NTT	Nippon Telegraph And Telephone Corporation
OMV	Orbital Maneuvering Vehicle
OOR	On-Orbit Refueler
ORU	Orbital Replaceable Unit
ORS	Orbital Refueling System
PAS	PanAmSat
PKM	Perigee Kick Motor
RMS	Remote Manipulator System
ROTEX	Robotic Technology Experiment
RTFX	Ranger Telerobotic Flight Experiment
RTSX	Ranger Telerobotic Shuttle Experiment
SAIC	Science Applications International Corporation
Sat DB	Satellite Information Database
SMAD	Space Mission Analysis and Design
SRMS	Shuttle Remote Manipulator System
SSL	Space Systems Laboratory
SSRMS	Space Station Remote Manipulator System
SUMO	Spacecraft for the Universal Modification of Orbits
TLE	Two Line Element
TPAD	Trunnion Pin Attachment Device
TWTA	Traveling Wave Tube Amplifier
USAF	United States Air Force
UMD	University of Maryland
USVCM	Unmanned Space Vehicle Cost Model
WIRE	Wide-Field Infrared Explorer
WO	Wrong Orbit
XIPS	Xenon Ion Propulsion System

Chapter 1

Introduction

Once launched, spacecraft are, with few exceptions, not readily accessible for rescue, repair, re-supply, or refurbishment. The idea of using robots for on-orbit servicing has been around since the beginning of space flight. Since then, a variety of assessments of the technical and economic feasibility of on-orbit servicing have been conducted. While a number of these studies have been insightful, they have suffered from various limitations, such as a lack of detailed spacecraft information and reliance on decision models based on uncontrollable, unknowable, or unpredictable parameters such as the discount rate. A more comprehensive, systematic approach with extensive spacecraft information is needed to provide a uniform basis for the assessment of proposed servicing scenarios. It is the goal of this thesis to identify an improved servicing decision method and then to utilize this method to characterize the various satellite servicing markets based on a comprehensive real world data set.

1.1 Motivations

There are a number of compelling reasons for examining the viability of telerobotic on-orbit servicing. Factors on the demand side include the economic opportunity provided by the continuing occurrence of significant on-orbit failures, the possibility of extending the useful life of high value spacecraft, and other servicing opportuni-

ties. Supply side considerations include the increasing capabilities of developmental space robots, the decreasing size and mass requirements for these robots, and new, potentially cheaper, alternatives for access to space.

1.1.1 On-Orbit Failures

To illustrate the economic opportunity of one type of on-orbit failure, consider the Orion 3 geostationary commercial communications satellite. On May 4th, 1999, the satellite was placed in an incorrect orbit due to a Delta III upper stage anomaly [11]. The second burn of the second stage (Centaur RL10B-2) was prematurely terminated after only 3 seconds of an intended 3 minutes of firing. This left the spacecraft very low in a 153 km by 1,380 km orbit versus an intended geosynchronous transfer orbit of 185 km by 25,956 km. Other than the low orbit, the spacecraft appears to have been operating nominally. In order to keep salvage options open, onboard fuel was used to place it into a 421 km by 1,294 km parking orbit.

The reported costs included the \$150M Hughes HS-601HP spacecraft and the \$80M Delta III launch. The satellite was declared a total loss with an eventual insurance payout of \$265M [13]. Orion 3 had 10 C-band and 33 Ku-band transponders and was intended to provide voice, data and internet service to Hawaii and the Asia-Pacific region. The spacecraft had a design life of 15 years and an estimated revenue per transponder of \$1M per year [33] (some sources go as high as \$2M per year). These characteristics imply that Orion 3 could have been generating \$43M or more per year. By abandoning the satellite, a potential revenue stream of \$645M over 15 years was also forgone. Clearly, providing a framework for evaluation of this type of scenario is of high interest.

Analyses of previous launches show that high value, wrong orbit type failures have occurred on average about once per year over the last 20 years. A summary of these failures is presented in Section 7.3. Other types of failures have different rates

of occurrence and are shown in the same section. Analysis of on-orbit failures and their occurrence rates will provide a basis for estimating the size of the market for servicing on-orbit failures.

1.1.2 Spacecraft Life Extension

The vast majority of costs involved in the geostationary telecommunications satellite business occur up front. After paying for satellite manufacture and launch costs, the ongoing operations costs are orders of magnitude lower. Given that most geosynchronous spacecraft reach the end of their station-keeping fuel before other major systems start to fail [57], a method for continuing the revenue stream of such a high value asset seems desirable.

An illustrative metric is the value of a kilogram of hydrazine in geosynchronous orbit. For instance, Superbird 4, a HS-601HP geosynchronous telecommunications spacecraft launched in February of 2000, cost an estimated \$150M to manufacture and \$100M to launch on an Ariane 44LP [14]. Its mass at the start of on-orbit operations was 2,460 kg. Its dry mass was reported at 1,657 kg, implying it had 803 kg of lifetime fuel. With a design life of 13 years that would result in about 62 kg of station-keeping fuel required per year. These calculations ignore the retirement burn, but that will be examined in detail in Section 7.4.1.3.

The satellite has 29 transponders (6 Ka-band and 23 Ku-band). These transponders can generate between \$1M and \$2M per year [33], therefore, a conservative estimate for its revenue stream is \$29 million per year. Dividing the annual revenue by the annual fuel requirement yields a value of \$468,000 per kilogram of fuel. From calculations in Appendix F, we find a typical delivery cost of about \$40,000 per kilogram to geosynchronous orbit. This in turn yields a value to cost ratio of over 10. Given a cost of only tens of dollars per kilogram [103] for hydrazine on the ground, there is clearly a rationale to further explore the market for on-orbit refueling or other

methods of extending the life of high value geostationary spacecraft.

1.1.3 Other Servicing Opportunities

In addition to mitigation of on-orbit failures and lifetime extension, other potential servicing scenarios include inspection, component upgrades, on-orbit assembly, and debris clearing. These opportunities are addressed in Chapter 7.

1.1.4 Advancing Robotic Capabilities

A number of organizations are continuing to advance the capabilities of space ratable dexterous robots. A review of servicing related robotic projects is included in Chapter 2. Of particular note are the efforts of the University of Maryland Space Systems Laboratory (SSL) and the NASA JSC Automation, Robotics, and Simulation Division.

The SSL Ranger Telerobotic Shuttle Experiment (RTSX) cleared the NASA Level 2 Shuttle Flight Safety Review and progressed to the point of assembling flight hardware before the program was terminated in June 2002. The Ranger prototype continues to make progress with demonstrations of servicing tasks. RTSX has the same reach envelope as an astronaut in an EVA suit [81]. It can exert the same force and torques as an astronaut as well. The RTSX dexterity approach is to use highly capable arms in combination with a number of interchangeable end effectors (some task specific, others suitable to a variety of operations). It is equipped with two dexterous 8 DOF arms with interchangeable end effector mechanism wrists. A grapple arm provides firm connection to a work target and a video arm provides situational awareness and other essential views during operations. In laboratory and neutral buoyancy simulation, RTSX and other SSL prototype arms have demonstrated key dexterous tasks needed for on-orbit servicing activities. A smaller, lighter, modular,

and reconfigurable version of the RTSX technology is currently under development.

Another advanced dexterous effort is the JSC Robonaut anthropomorphic robot [42]. Using mechatronic hands, it can utilize the same tools as EVA astronauts. It has been under development for a number of years, and has also successfully demonstrated servicing related dexterous capabilities. While its arms currently operate at lower tip speeds than RTSX, its anthropomorphic design enables intuitive teleoperation.

Both of these projects are in the process of demonstrating robots capable of fulfilling the dexterous requirements of many satellite servicing scenarios. Figure 1.1 shows how Robonaut is able to utilize any human compatible tool or interface. Ranger, on the other hand, is able to interact with any EVA or EVR interface. Because it has time delay mitigation built in, Ranger is also controllable via all major control approaches. These advancing dexterous robotic capabilities will enable the completion of complex on-orbit satellite servicing tasks.

How the Operator Interacts with the Robot

	Locally Teleoperated (Flight Crew)	Remote Teleoperated (Ground)	Supervisory/ Autonomous Control
How the Robot Interacts with the Workspace	Specialized Robotic Interfaces	SSRMS MFD MSS/SPDM	Charlotte IVA
	EVA Compatible Interfaces	←	←
	Human Compatible Interfaces	Robonaut	

	Ranger TSX	
--	-------------------	--

	ROTEX ETS-VII	
--	--------------------------	--

Figure 1.1: Space Robot Matrix [41]

1.1.5 New Launch Alternatives

A number of new launchers are coming on line in the near term. Lower launch costs will influence any servicing mission decisions. Upcoming small launchers include RASCAL [37] and FALCON [32]. These two launchers are of interest for LEO satellite servicing scenarios. Both are aiming for lower cost per kg to orbit, and RASCAL also will be able to plan and launch a mission much more rapidly than any current launch vehicle. This capability will enable a rapid response to a troubled LEO satellite that would otherwise re-enter before a rescue mission could be mounted by a conventional launch system.

Other new launch opportunities include auxiliary payload locations on new heavy launchers such as the Atlas V [24] and possibly the Delta IV [21]. In the case of a servicing vehicle with a much lower mass than a typical satellite, the option to launch to GEO at a fraction (\$6M to \$10M) of the cost of a typical (\$50M to

\$80M) GEO payload launch would be a substantial benefit. See Appendix F for more information on current launch costs.

1.2 Dissertation Overview

Previous efforts to determine the criteria for deciding when on-orbit servicing is appropriate have been limited by simplifying assumptions, lack of detailed satellite information including costs and benefits, and failure to address operational uncertainties. The aim of this research is to devise an improved method for evaluating the feasibility of telerobotic on-orbit satellite servicing scenarios. In order to reach this aim, a number of steps have been taken.

- Chapter 2 is a review of **background** material on satellites, space robots, and on-orbit servicing.
- Chapter 3 is an analysis of **previous** economic studies. The limitations and strengths of these studies are identified.
- Based on the limitations of the previous studies, a new, expected-value based **methodology** is developed in Chapter 4.
- Chapter 5 describes the development of the detailed spacecraft and on-orbit failure **databases** at the core of this analysis.
- Based on these databases, Chapter 6 presents **trends** over time for key spacecraft characteristics.
- Chapter 7 includes identification and analysis of on-orbit servicing **opportunities** derived from the databases.

- Based on analysis of these opportunities, Chapter 8 utilizes the new servicing feasibility evaluation method to characterize the markets for various servicing **missions**.
- Chapter 9 demonstrates an **example** satellite servicing feasibility assessment based on the market characterizations. A small, light dexterous servicer is evaluated against the geosynchronous retirement mission.
- Finally, the **conclusion** in Chapter 10 includes discussion of results and recommendations for further research.

1.3 Contributions

The original contributions of this work include a consistent method for evaluating the feasibility of satellite servicing, a detailed catalog of on-orbit satellite failures, and a survey of lifetime extension opportunities for currently active satellites. A new method of evaluating servicing feasibility is developed in Chapter 4 and Chapter 8, and it is demonstrated in Chapter 9. The analysis of the catalog of on-orbit failures is shown in Chapter 7. Catalog information includes event data, spacecraft health, and prospects for servicing. Event analysis includes frequency of events by type and costs incurred. Such information and analysis is not available in any other open source form. The survey of lifetime extension opportunities is also shown in Chapter 7. It includes a range of options to extend the life of current spacecraft based on historical lifetime information.

A key feature of this analysis is that it is not predicated on the redesign of spacecraft. It identifies servicing opportunities against existing, operational spacecraft rather than making a case, as seen in a number of previous studies in Chapter 3, to modify the design of future spacecraft.

By incorporating the best aspects of previous models, addressing unaccounted for operational uncertainties, and including actual, detailed spacecraft data, this new servicing feasibility method enables better understanding of future servicing applications, requirements for on-orbit servicing operations, effects of servicing on spacecraft mission assurance, and the overall question of the economic viability of on-orbit servicing.

Chapter 2

Background

This chapter provides background information on satellite servicing, previous satellite servicing efforts, and upcoming satellite servicing technology demonstrations.

2.1 The Satellite Servicing Problem

The phrase “satellite servicing” means many things to many people. For this study, it is used in a broad sense. Servicing is defined as being any service provided on-orbit by one spacecraft to another. An example would be for one spacecraft to refuel another spacecraft. The intervention of human crew to provide such services has been amply demonstrated in vehicles such as Skylab, Shuttle, Mir, and ISS. Because of the high cost of human spaceflight activities, hazard to crew during EVA, and current limit of crew to LEO operations, this study will focus on investigating robotic approaches instead.

The continuing advances in robotic capabilities suggest that servicing systems are becoming viable candidates when responding to on-orbit spacecraft needs. As seen in Figure 2.1, the concept of robotic satellite servicing has been around since the beginnings of space flight. The ground prototype shown in Figure 2.2 and other robotic systems have demonstrated that key satellite servicing capabilities are achievable today.

Spacecraft services can range from a simple inspection mission to a complex dexterous servicing task, such as refueling a spacecraft not designed for robotic access. All types of servicing missions are made up of a number of phases. These phases are shown below and are essentially chronological. For our purposes, the spacecraft providing services is called the servicer and the spacecraft receiving services is called the target.

- **Launch** - The first step is to get the servicer into orbit.
- **Rendezvous** - From some initial orbit, the servicer needs to maneuver to the target spacecraft.
- **Inspection** - An initial inspection is usually required. For some missions, inspection is the only service required.
- **Docking** - For any repair or refueling mission, the servicer must connect to the target to begin operations.
- **Relocation** - In some cases the servicer will relocate the target to a new orbital location.
- **Dexterous** - For a number of servicing scenarios, the servicer must perform dexterous operations to repair or resupply the target.
- **Departure** - At the conclusion of servicing, the servicer will undock and depart from the area of the target spacecraft. This phase could also include final inspection.

While a variety of spacecraft services can be envisioned, they can all be identified as belonging to one of three general categories, which include failure mitigation, lifetime extension, and other services. Each of these services are described in the following sections.

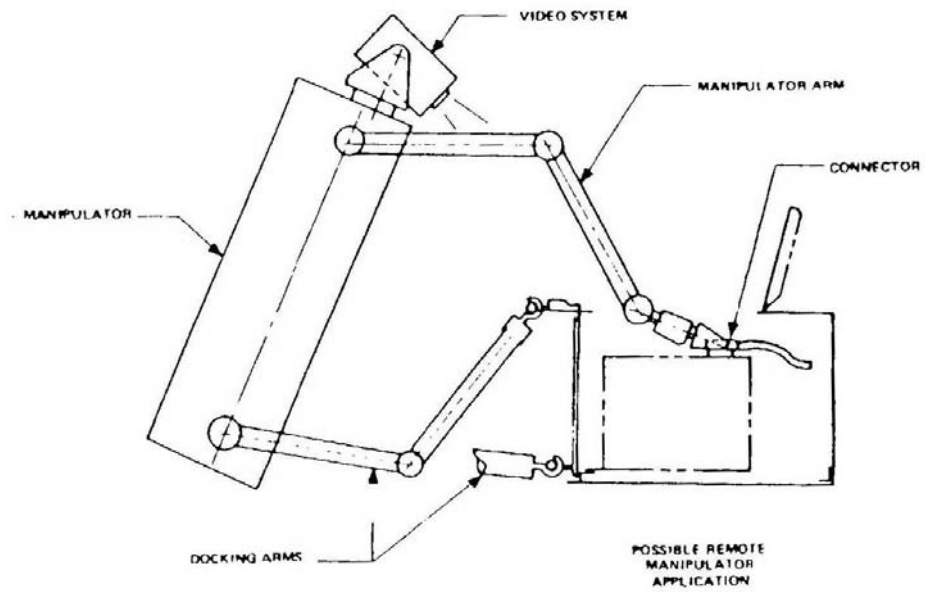

Figure 2.1: On-Orbit Servicing Robot Concept From 1969 [65]

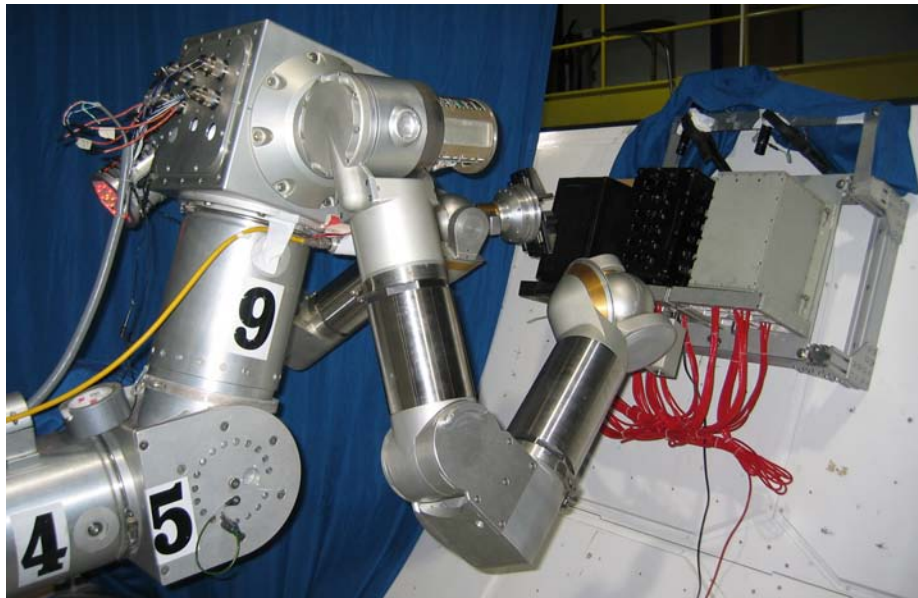

Figure 2.2: On-Orbit Servicing Robot Ground Demonstration, 2004 (RTSX) [34]

2.1.1 Servicing Failures

A primary motivator for this analysis is the regular occurrence of on-orbit failures. A variety of anomalies can occur during a satellite's journey from the launch pad to its on-orbit operational location. During the launch phase, catastrophic launch vehicle failure or premature launch vehicle engine shutdown both result in launch vehicle loss with no chance of satellite rescue.

Even after a successful launch, other hazards await. Once on-orbit, the satellite can be placed in an incorrect orbit, fail to separate correctly from an upper stage, fail to correctly deploy stowed appendages (such as solar arrays or antennas), or suffer some other malfunction that prevents initial operations.

During its subsequent operational lifetime, the satellite may prematurely deplete its fuel supply. Components may fail completely or suffer degraded capabilities due to the space environment. There are a number of other problems that can degrade or terminate operations as well. The historic occurrence of on-orbit failures and opportunities to mediate them are examined in Chapter 7. On-orbit failure mitigation services include:

- **Orbit correction** - Relocation of the target spacecraft from an incorrect initial launch delivery location.
- **Deployment assistance** - Assistance with deployment of solar arrays, antennas, or other deployable appendages.
- **Component repair** - Repair or replacement of failed components.
- **Consumables resupply** - Resupply of fuel, coolant, or other depleted consumables.
- **Removal** - Transfer of the failed target spacecraft from a working orbit (such as geostationary) to a retirement location. Retirement can be either relocation

to a “graveyard” orbit or de-orbit into the atmosphere.

Figure 2.3 illustrates the many possible paths for a satellite from launch to end of life, any number of which lead to mission failure or degrade operational capability. In response, Figure 2.4 shows the many opportunities for servicing intervention to mediate failures or extend the life of operational satellites.

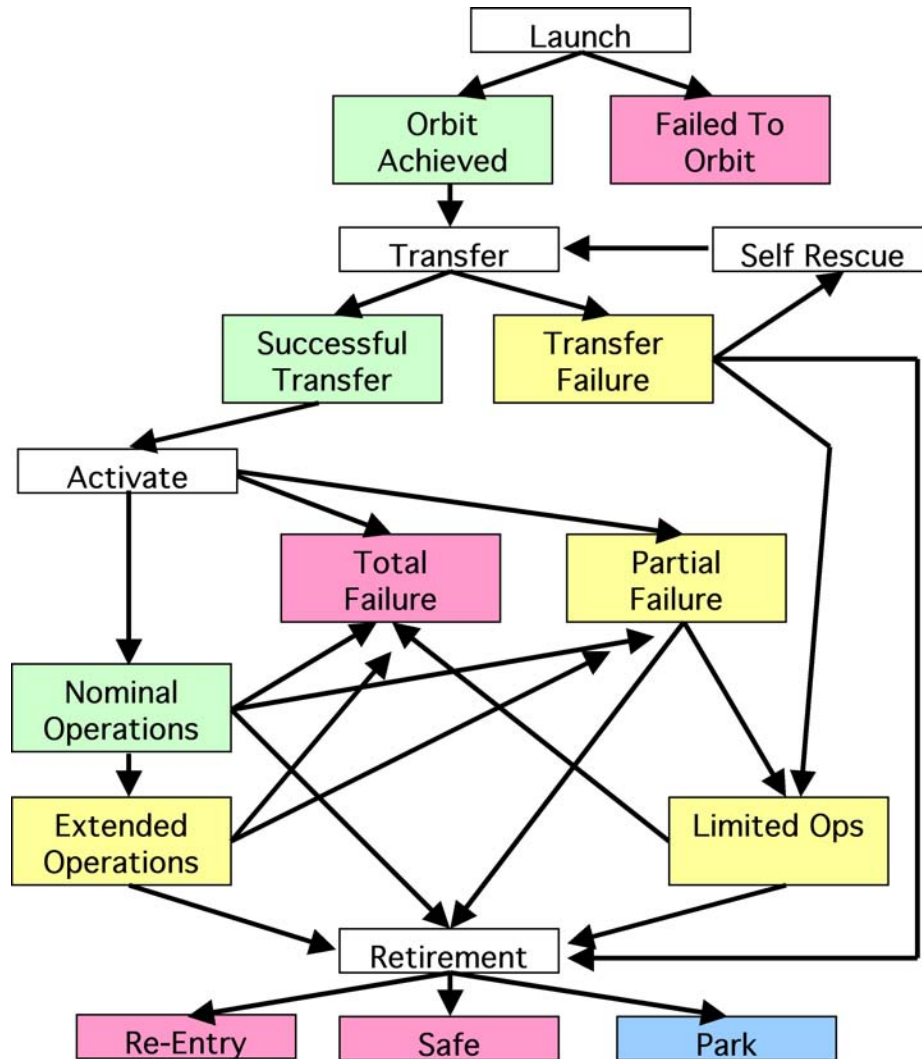

Figure 2.3: The Life Paths Of An Unserviced Satellite

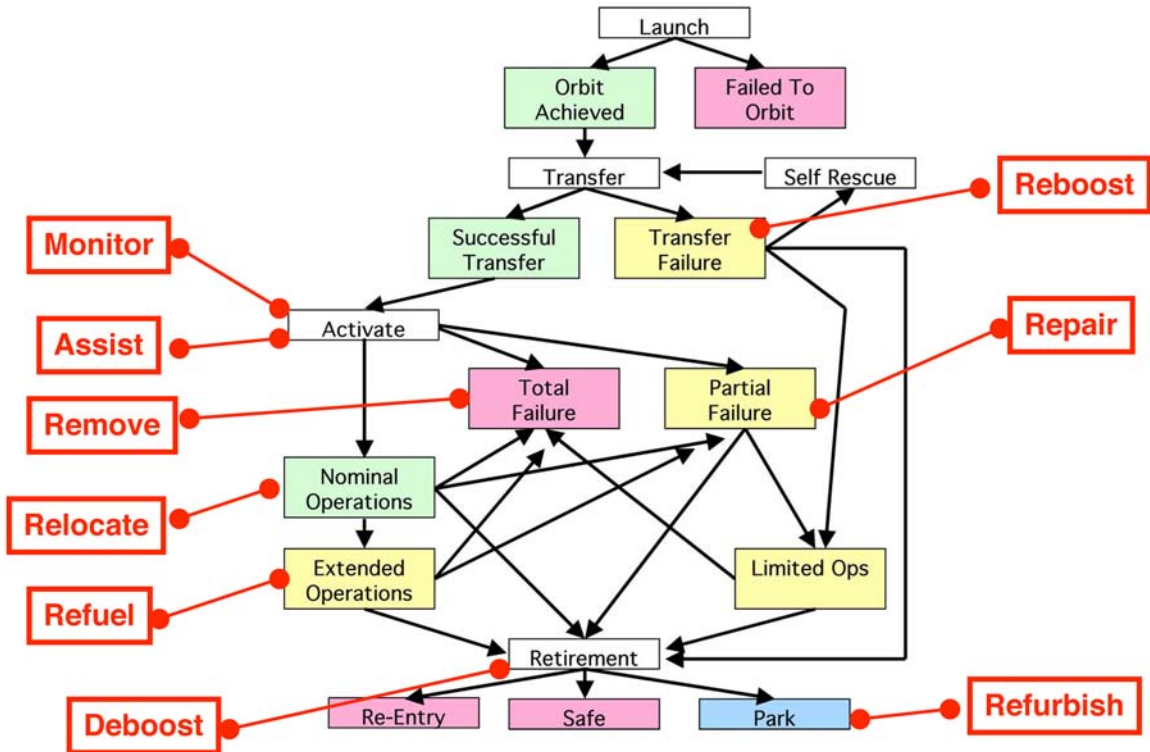

Figure 2.4: Satellite Servicing Opportunities

2.1.2 Spacecraft Lifetime Extension

A number of mostly healthy spacecraft are retired because of some limiting factor. For instance, the lifetime of commercial geostationary communications spacecraft are often constrained by their lifetime fuel supply [57]. Spacecraft lifetime extension services include:

- **Relocation** - Transfer of the target spacecraft to a new operating orbit. This could even include initial orbit delivery, converting that maneuvering fuel into lifetime fuel.
- **Consumables resupply** - Resupply of fuel, coolant, or other depleted consumables.
- **Component replacement** - Replacement of degraded components. Also

upgrade, where addition of more capable components increase the satellite's utility.

- **Removal** - Transfer of the target spacecraft from a working orbit (such as geostationary) to a retirement location. In this case the relocation by a servicer allows the target to expend its retirement maneuver fuel as lifetime station-keeping fuel thus extending its non-refueled duration.

Examples of lifetime extension scenarios are explored in detail in Chapter 7.

2.1.3 Other Services

Beyond servicing failures or providing lifetime extension, other services are also conceivable, including:

- **Inspection** - Close inspection of a target spacecraft for deployment assurance, health monitoring, insurance claim verification, or other purposes.
- **Removal** - Transfer of debris (typically upper stage components or inactive, tumbling satellites) from a working orbit (such as geostationary) to a disposal location. This would be an indirect service that reduces the collision hazard to operational spacecraft.
- **Assembly** - A servicer could be used to construct spacecraft requiring multiple launches.
- **Scavenging** - Functional components retrieved from a retiring spacecraft could be used to repair degraded spacecraft.

Examples of other services are explored in detail in Chapter 7.

2.2 A Brief History Of On-Orbit Servicing

A number of the services described in the preceding sections have already occurred on orbit. The following sections describe various satellite servicing missions and technology demonstrations that have been accomplished. While there have been some robotic servicing demonstrations on-orbit, most of the actual servicing missions have been Shuttle based missions. The exception is satellite self-rescues which are also described.

2.2.1 Space Shuttle Based Satellite Servicing Missions

There have been a number of Space Shuttle based satellite servicing missions, which are shown below in Table 2.1. During the early missions, target spacecraft were retrieved by EVA astronauts. In this case, after the Shuttle maneuvered to a point near the satellite, a free-flying EVA astronaut on Manned Maneuvering Unit (MMU) used a specially designed capture mechanism to take control of the satellite. For the Hubble Space Telescope (HST), the Shuttle's Remote Manipulator System (RMS) was used to directly grasp a grapple fixture and placed HST into a work fixture. Repair work was then performed by EVA astronauts in the payload bay of the orbiter. Not all of these spacecraft listed were serviced on-orbit. On the STS-51A mission, two satellites were retrieved and returned to the earth for refurbishment and relaunch. Images of these servicing missions are shown in Table 2.2.

HST and Solar Max are NASA LEO science platforms. All of the other spacecraft are commercial geostationary telecommunications spacecraft.

Year	Flight	Mission	Cap- ture	Capability Demonstrated
1984	STS-41C	Solar Maximum Repair	EVA	Component replacement
1984	STS-51A	Palapa B2 & Westar 6	EVA	Spacecraft return to Earth
1985	STS-51I	Leasat 3	EVA	Spacecraft repair
1992	STS-49	Intelsat 603 Repair	EVA	Upper Stage replacement
1993	STS-61	Hubble Space Telescope	RMS	Spacecraft upgrade
1997	STS-82	Hubble Space Telescope	RMS	Spacecraft upgrade
1999	STS-103	Hubble Space Telescope	RMS	Spacecraft upgrade
2002	STS-109	Hubble Space Telescope	RMS	Spacecraft upgrade

Table 2.1: Shuttle Based Satellite Servicing Missions





 <p>A satellite with two large rectangular solar panel arrays is shown in space against a black background.</p>	 <p>A satellite with a cylindrical body and a large antenna is being retrieved by a shuttle arm, with the Earth's horizon visible in the background.</p>
<p>Solar Max Retrieval [31]</p>	<p>Westar 6 Retrieval [31]</p>
 <p>Astronauts are working on the exterior of a shuttle, with a large satellite component being moved or stowed.</p>	 <p>Astronauts are performing a repair on a satellite using a shuttle's robotic arm.</p>
<p>Stowing Palapa B2[31]</p>	<p>Leasat 3 Repair [31]</p>
 <p>A large satellite is being rescued or moved by a shuttle arm, with the Earth's horizon visible.</p>	 <p>The Hubble Space Telescope is being serviced by a shuttle arm, showing its distinctive yellow solar panels.</p>
<p>Intelsat 603 Rescue [31]</p>	<p>HST Servicing [31]</p>

Table 2.2: Shuttle Based EVA Satellite Servicing Missions

2.2.2 Satellite Self Rescues

As shown in Table 2.3, a number of satellites that were delivered to incorrect initial orbits utilized onboard lifetime fuel to achieve proper orbit. These events are explored in more detail in Section 7.3. Notably, Asiasat 3, now named HGS-1, recovered from an incorrect orbital insertion by performing 2 lunar flybys to achieve geosynchronous orbit. Information for this table is from the Satellite Information Database. Its sources are identified in Section 5.1.2.

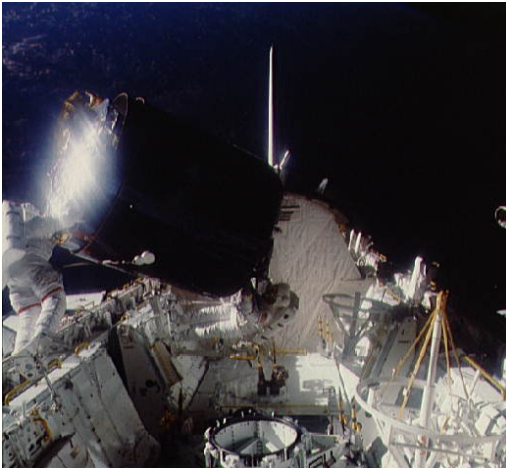
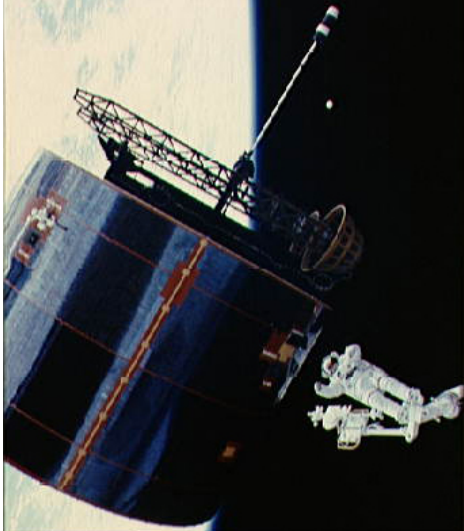
#	Year	Satellite	Method To Reach GEO	Value (\$M)	Basis
1	1988	GStar 3	Used onboard fuel	65	Insurance Claim
2	1993	UFO 1	Used onboard fuel	188	Insurance Claim
3	1995	Koreasat 1	Used onboard fuel	64	Insurance Claim
4	1997	Agila 2	Used onboard fuel	290	Spacecraft Value
5	1997	HGS-1	Used lunar flyby	215	Insurance Claim
6	2001	GSAT 1	Used onboard fuel		Unpublished
7	2001	Artemis	Used onboard fuel	75	Insurance Claim

Table 2.3: GEO Spacecraft Which Utilized Onboard Fuel To Overcome Launch Anomalies

2.2.3 Space Shuttle Based Servicing Technology Demonstrations

A number of servicing technology demonstrations have occurred on Shuttle and Station missions. As mentioned previously, satellite capture has been made by both EVA and RMS. The basic capability to change out ORUs has been shown on numerous occasions by EVA astronauts, particularly on HST servicing missions. An on-orbit fuel transfer demonstration on a Landsat type of fuel port was successfully accomplished on STS-51G by EVA in the Orbital Refueling System (ORS) experiment.

Robot capabilities have been demonstrated as well. The SRMS and SSRMS have performed ably as cranes. ROTEX on STS-55 was an enclosed dexterous robotic

experiment. A larger dexterous demonstration was performed by the Japanese MFD experiment on STS-85. This hardware is a precursor to JAXA's Small Fine Arm (SFA) for external ISS robotic operations. Among the tasks demonstrated was robotic ORU change out and opening and closing a door. Free flying robotic inspection capability was achieved on STS-87 with the flight of AERCam. Images of these demonstrations are shown in Table 2.4.

	
<p>AERCam [23]</p>	<p>MFD [23]</p>
	
<p>ROTEX [22]</p>	

Table 2.4: Shuttle Based Robotic Servicing Demonstrations

2.2.4 Other On-Orbit Servicing Technology Demonstrations

A number of non-Shuttle-based servicing technology demonstration missions have also occurred. These included Inspector, ETS-VII, and XSS-10. Images of these vehicles are shown in Table 2.5.

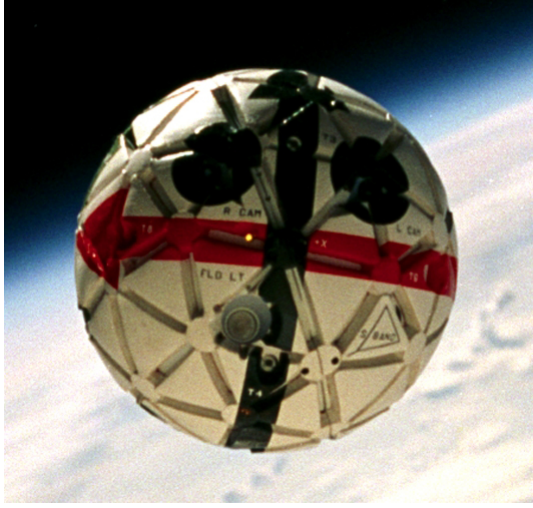
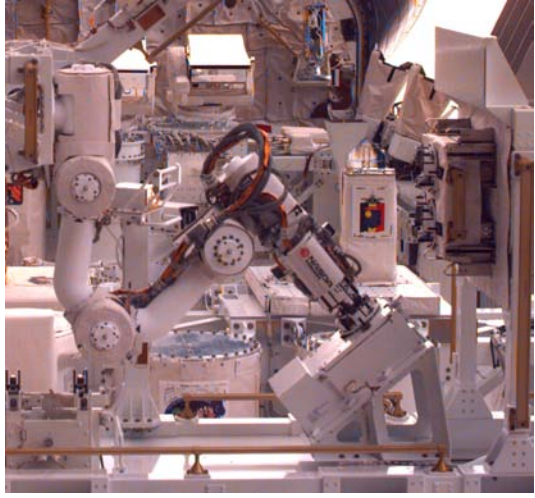
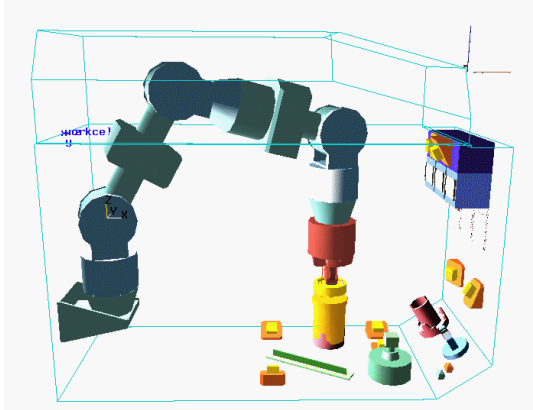

 <p>ETS-VII [38]</p>	 <p>Mir-Inspector [66]</p>
 <p>XSS-10 [16]</p>	

Table 2.5: On-Orbit Robotic Servicing Technology Demonstrations

The German built Inspector mission was a partially successful demonstration near Mir in 1997. It was intended to perform an external survey of the station. After deployment from a Progress spacecraft, ground controllers lost contact with the vehicle. Control was eventually recovered, but Inspector was then too far from Mir to return. Inspector relied on ground commands to get into correct position for imaging operations.

The 1997 Japanese ETS-VII mission successfully executed autonomous rendezvous and docking via a latching mechanism; ground controlled rendezvous and docking; autonomous capture of a target satellite with a robot arm; inspection; and

various manipulator operations. The target half of the docking mechanism was substantial in size and mass. With the exception of refueling, ETS-VII demonstrated almost all phases of satellite servicing. All of the interfaces were explicitly designed for robotic operations.

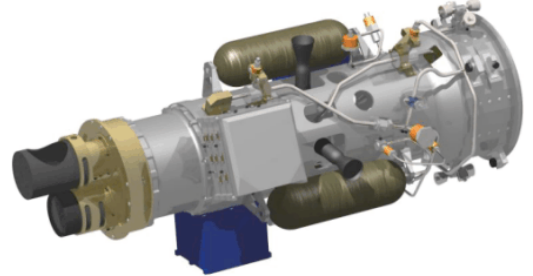
In 2003 the AFRL XSS-10 microsatellite flew as an auxiliary payload attached to a Delta II upper stage. XSS-10 massed 28 kg and was battery powered. It successfully performed close-in proximity maneuvering and close inspection of the upper stage.

2.3 Future Servicing Technology Demonstrations

A number of flight programs are in progress that will advance the extent of robotic servicing capabilities demonstrated in space. There are also a number of continuing research programs advancing the level of robotic dexterity in hopes of future flight opportunities. The following sections describe some of these programs.

2.3.1 Future Servicing Technology Flight Missions

A number of capable servicing missions are on the near horizon. They are shown in Table 2.6 and described briefly below.

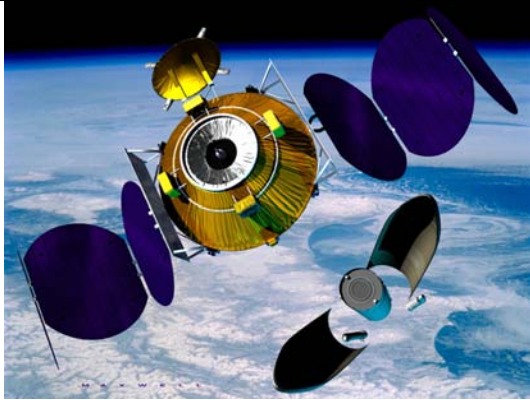

Cone Express [27]

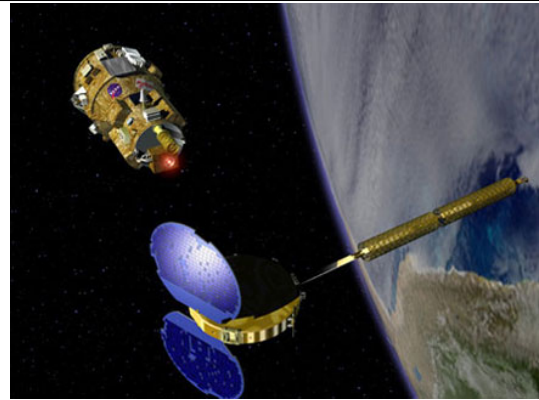

DART [28]



miniAERCam [25]

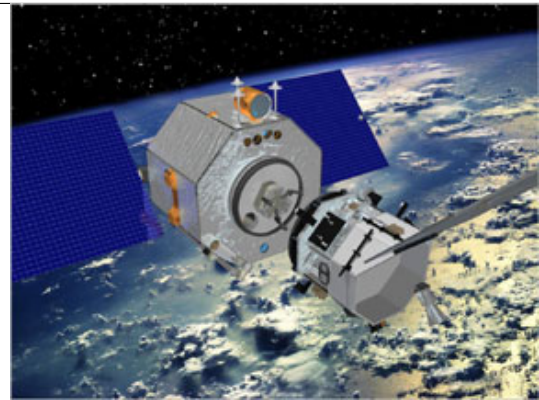

Orbital Express [37]



SPDM [20]

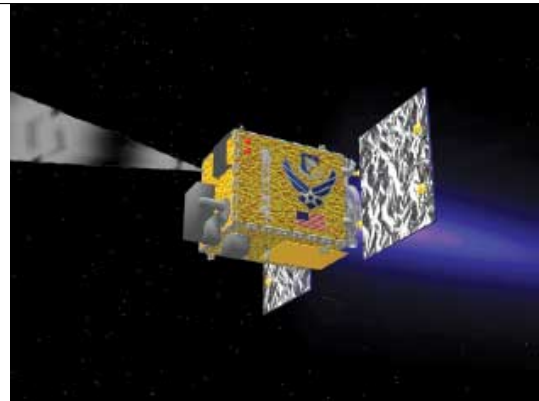

XSS-11 [18]

Table 2.6: Upcoming Robotic Servicing Demonstration Missions

2.3.1.1 Cone Express

Orbital Recovery Corporation is developing a vehicle to extend the life of a geosynchronous spacecraft [27]. Their approach is to fly an additional spacecraft bus up to an existing spacecraft that is low on fuel. After docking via the apogee kick motor, Cone Express will provide North-South and other station keeping maneuvers to extend the useful life of the target spacecraft. A novel approach in the design is that Cone Express serves as the interstage connector on a launch of other geostationary spacecraft.

2.3.1.2 DART

The Demonstration of Autonomous Rendezvous Technology (DART) project will demonstrate autonomous capability to locate and rendezvous with another spacecraft [28]. The DART vehicle will be launched by a Pegasus rocket and inserted into a circular low earth orbit. DART will then maneuver to a point near a target satellite using GPS. Using its Advanced Video Guidance Sensor (AVGS), DART will perform a series of proximity operations including station keeping, docking approaches, and circumnavigation. Finally, the vehicle will demonstrate a collision avoidance maneuver and then transit to its final orbit. All operations will be performed autonomously. DART is sponsored by NASA and is being constructed by Orbital Sciences Corporation.

2.3.1.3 Mini AERCam

NASA is developing a next generation of the Autonomous Extravehicular Robotic Camera (AERCam) [25]. Mini-AERCam is a small, free flying inspection vehicle, and it will be capable of performing close imaging duties for both the International Space Station (ISS) and the Shuttle. For ISS operations, AERCam would function in both teleoperated and autonomous modes. For an autonomous mission, the free-flyer

would deploy, maneuver to a target area while avoiding obstacles, acquire the needed views, return to home base, dock, and recharge.

2.3.1.4 Orbital Express

DARPA is conducting a program named Orbital Express to demonstrate autonomous spacecraft servicing capabilities [37]. The flight experiment consists of two vehicles. Boeing is building the servicer called ASTRO, and Ball Aerospace is building the target called NextSat. Launch is slated for 2005. Purpose built interface mechanisms and fluid couplers are part of the hardware suite.

2.3.1.5 SPDM

To complete the Mobile Servicing System (MSS) on ISS, the SPDM will be delivered to work in concert with the SSMRS and Mobile Base System (MBS) [20]. The MBS will provide transport along the rails on the front face of the truss; the SSRMS will provide crane capabilities to move large payloads around; and the SPDM will provide the end point dexterous capability to replace robot compatible ORUs such as MDMs, DDCUs, and IEA batteries. SPDM has been completed and is awaiting a spot on the Shuttle manifest for a flight to the ISS.

2.3.1.6 XSS11

The USAF's AFRL is constructing XSS-11 as a follow-on to the XSS-10 mission [18]. This solar powered micro-satellite will have a much longer life than the battery powered XSS-10. It is intended to extend the understanding of autonomous proximity operations, and will use US-owned derelict rocket bodies as rendezvous targets. An additional goal is to demonstrate technologies needed to enable NASA to use spacecraft to autonomously return Mars samples to Earth for analysis. XSS-11 is scheduled for launch in late 2004.

2.3.2 Dexterous Robotic Servicing Research Programs

A number of capable robotic servicing research programs are in development and are shown in Table 2.7. Ranger and Robonaut are described briefly in Section 1.1.4. SUMO (Spacecraft for the Universal Modification of Orbits) is a DARPA program under development at the Naval Research Laboratory. The program is intended to explore the space tug mission for target spacecraft relocation.



 A photograph of the Ranger TSX robotic arm, a silver, multi-jointed mechanical structure with joints labeled with the numbers 4, 5, and 9. It is positioned against a blue background.	 A photograph of the Robonaut, a humanoid robot with a white, muscular body and a gold-colored helmet. It is wearing a NASA logo and a BARPA logo on its chest. The robot is standing on a platform and holding a small object in its right hand.
Ranger TSX [34]	Robonaut [42]
 A diagram of the SUMO spacecraft, a yellow and white satellite with blue solar panels. The diagram is annotated with labels and arrows pointing to various components: Robot Arms, Machine Vision, Tool Box, Payload Module, and Propulsion Module.	
SUMO [44]	

Table 2.7: Ongoing Robotic Servicing Research Projects

2.4 Robotic Serviceability Of Satellites

2.4.1 Target Satellites

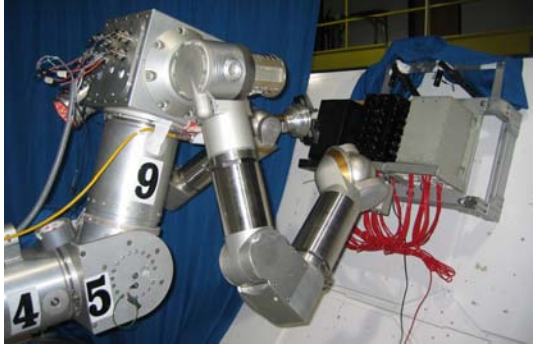
Currently, the only on-orbit spacecraft designed for servicing are HST and ISS. The chicken-and-egg of servicing is as follows. Because there are no servicers, satellites are not designed for servicing, and because satellites are not designed for servicing, there is no requirement for servicers. Designing serviceability into spacecraft costs launch mass. Any such mass must be carved out of either payload mass or spacecraft fuel. These both affect satellite revenue directly. While a number of previous studies, as seen in Chapter 3, make the case to include serviceability into the design of future spacecraft, current satellites present many opportunities. Because current spacecraft are not designed for servicing, the dexterity requirements for the first servicing missions are higher than they would be for new spacecraft designed with servicing in mind.

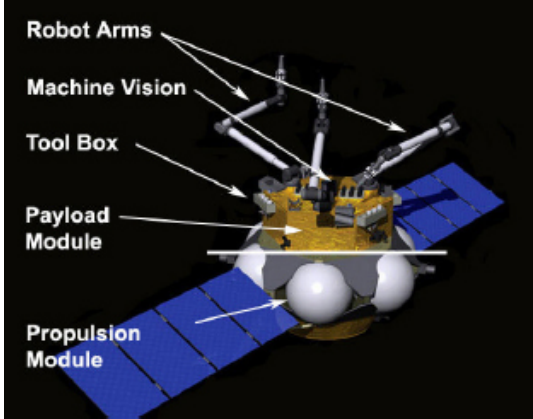
Quantifying the serviceability of current satellites is problematic. Ideally, target satellites would have beacons and radar targets for ease of rendezvous. A defined docking approach corridor, docking aids (such as visual targets), docking success indicators, and other items would facilitate docking. For dexterous servicing, fuel ports would have standard quick-connect interfaces, and replaceable units would be standardized, well marked, and readily accessible. Control of the combined stack would be handled seamlessly.

Early servicing missions will have exactly the opposite of the characteristics described above. Early servicing robots will have to be more capable than follow-on devices operating on next-generation serviceable satellites because they will be operating with hardware not designed specifically to enable robotic servicing.

2.4.2 Servicers

On the servicer side of the equation, a telerobotic servicer will include both a somewhat familiar spacecraft bus and a new robotic servicing payload. Challenges to telerobotic servicing encompass many areas, including remote operations with time delay (on the order of 2 seconds), visual and force feedback for 6 DOF dexterous tasks, an effective multi-manipulator control interface, joint vehicle control, safe configurations during loss of signal, and many more issues that are being addressed in laboratories (UMD, CMU, MIT, Stanford, etc.), government (NASA JSC), and industry today. Two of the key operational robotic capabilities, docking and refueling, are discussed in the following sections.

2.4.2.1 Robotic Docking

Rendezvous, proximity operations, and docking have been demonstrated by a wide variety of crewed and supervised robotic (i.e. Progress capsules) vehicles. Autonomous robotic docking was successfully demonstrated by ETS-VII in 1997 [80], [63], [53]. In this case the target vehicle had a built-in docking interface. A more generic approach likely will be required to enable servicing. For some targets, docking could be accomplished via the launch interface ring on the base of the satellite or the AKM nozzle. The Ranger technology development program has recently performed a simulated 6 DOF docking simulation at the NRL facilities as seen in Figure 2.5. The NRL SUMO [44] docking concept appears promising as well.

In addition to the launch adaptor ring, using the AKM nozzle has also been investigated as a docking location. In particular, there is the inflatable stinger concept from NASA JSC as seen in Figure 2.7. An ESA proposed AKM docking method is shown in Figure 2.6. Both appear feasible but have not yet been proven.

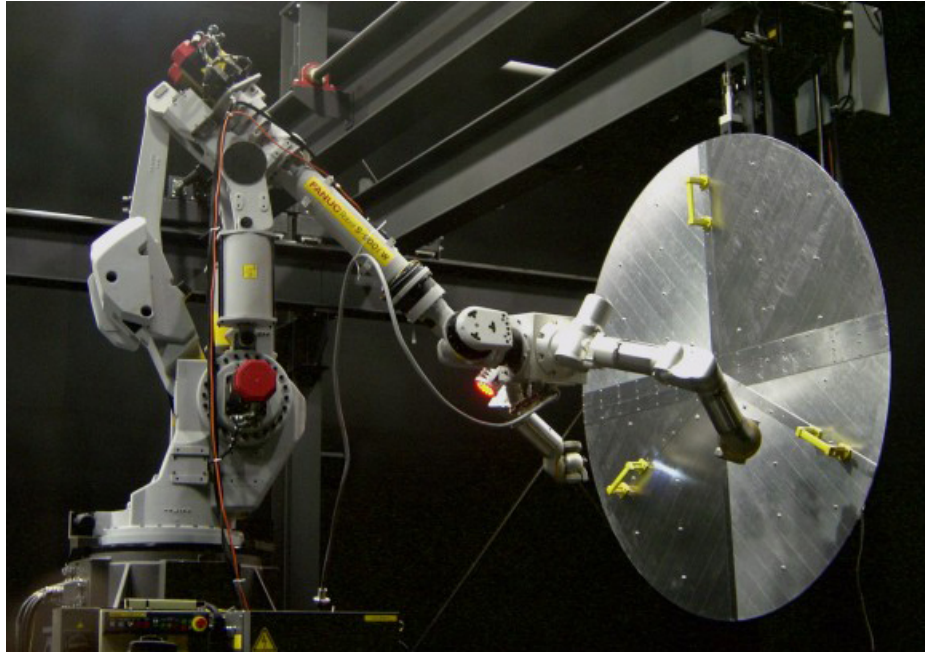

Figure 2.5: Ranger TSX Prepares To Dock With A Simulated Spacecraft [34]

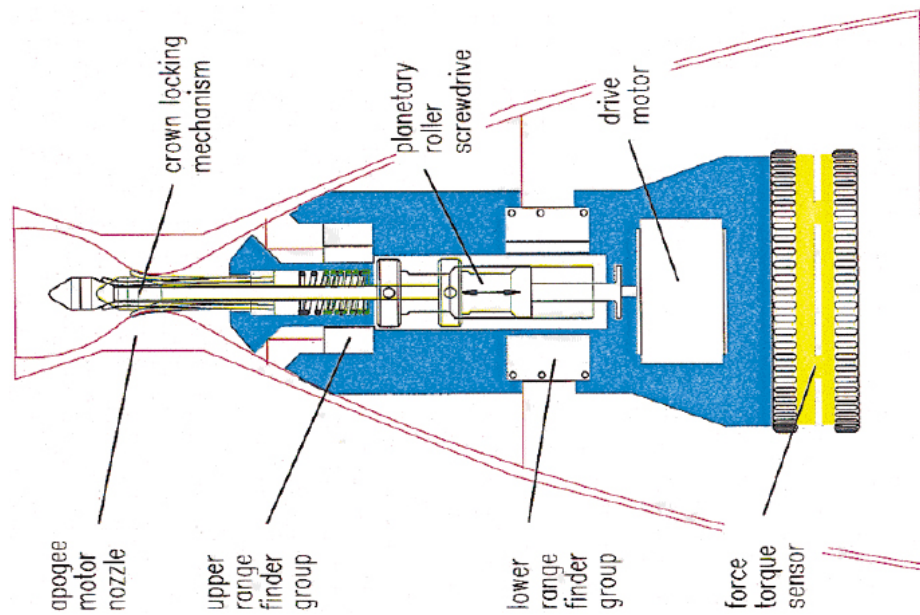

Figure 2.6: ESA Crown Locking Mechanism [58]

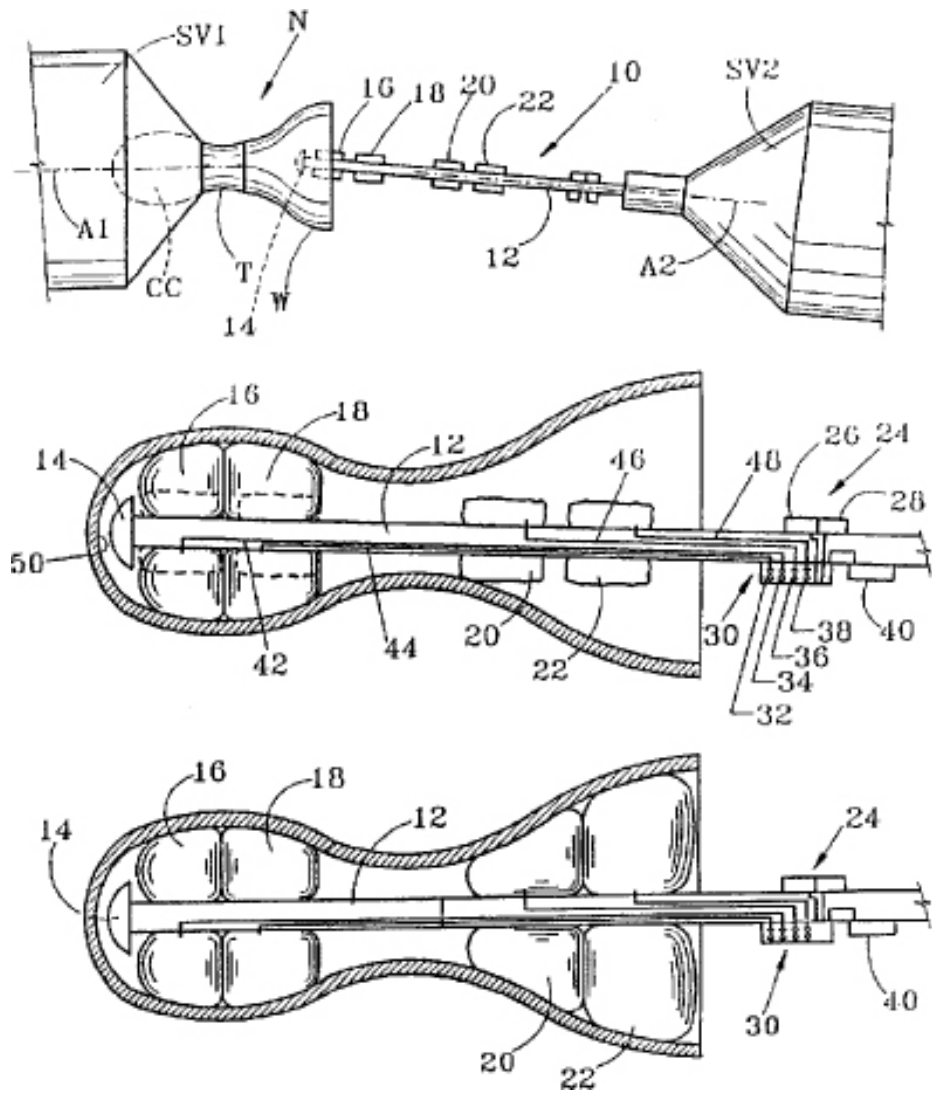

Figure 2.7: Apparatus for Attaching Two Spacecraft Under Remote Control [86], [87]

2.4.2.2 Robotic Refueling

In order to perform a refueling mission for a current satellite, a servicer needs the capability to access the ground fuel port on the target satellite and attach fueling lines. In 1985, Shuttle astronauts successfully demonstrated repeated on-orbit fuel transfer between a fuel supply and a Landsat satellite type of fuel port. Images from the demonstration are shown in Table 2.8 and Table 2.9. Examining the EVA timeline [46], tool list, and crew tasks, the Ranger TSX appears to have dexterous capability required to perform the refueling task. This observation is not intended to imply that Ranger is the only robot capable of tasks of such complexity, but that at least one such robot currently exists.

An alternative to the fuel transfer approach is to simply attach an additional propulsion module to a target satellite, as proposed by the Orbital Recovery Corporation [27]. While this approach reduces the use of dexterous robotics, it does include transporting and attaching the substantial mass of an additional propulsion system rather than transferring only fuel.



 <p>STS 41-G Cargo Configuration</p> <p>Labels: ORS, LFC-MPESS, ERBS, GAS (2), OSTA-3, GAS (2), IMAX, APE, TLD, CANEX, RME, GAS (4), RMS</p>	
 <p>Astronauts Performing ORS Demonstration [31]</p>	 <p>Labels: TRANSLATION STRAP, RETRACTING TETHERS, RELIEF VALVE VENT, GN2 CATALYTIC VENT, HANDHOLDS, TOOL CADDY MOUNTS</p> <p>ORS Worksite Drawing [46]</p>

Table 2.8: ORS - Shuttle Based Refueling Demonstration

 <p>ORS EVA Tool Box [46]</p>	 <p>DUST CAPS LOCKWIRE</p> <p>ORS Valve Dustcaps [46]</p>
 <p>ORS Valve Lockwire [46]</p>	 <p>ORS Valve [46]</p>

Table 2.9: ORS - Shuttle Based Refueling Demonstration

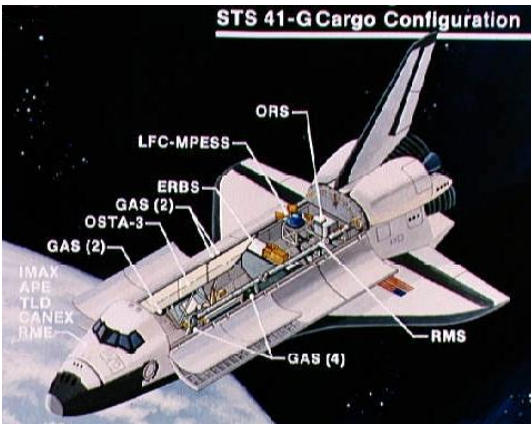
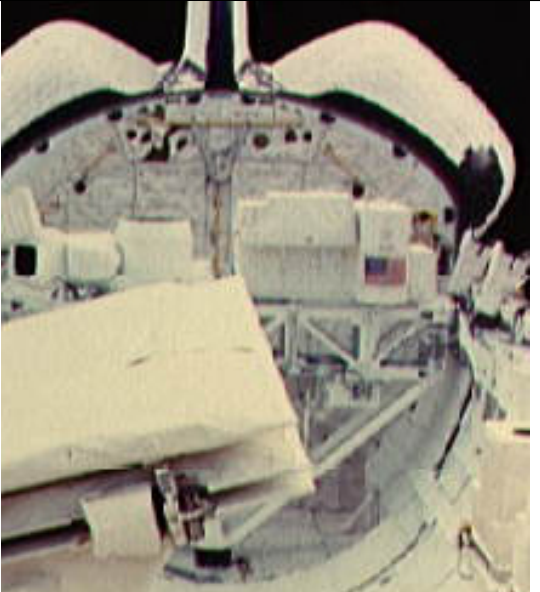
Chapter 3

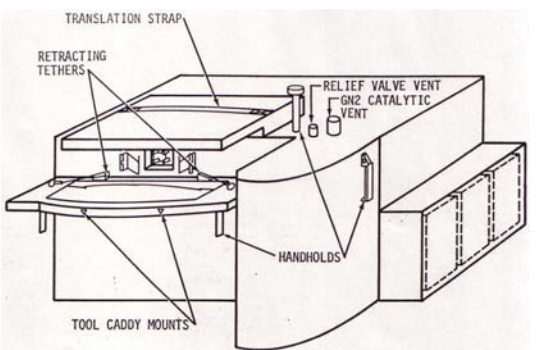
Previous Satellite Servicing Economic Models

The basic question here is the same as for any economic decision. Does the benefit of servicing outweigh the cost? A number of previous studies have addressed this question with a variety of economic evaluation methods, assumptions, and results. The following sections examine previous servicing economic analyses. The papers and reports reviewed include some level of detail in their economic models. The goal of this review is to identify the strengths and limitations of these models. An evaluation of the previous studies is included at the end of this chapter. This information will be used for adaptation or extension to a new satellite servicing decision analysis method in Chapter 4.

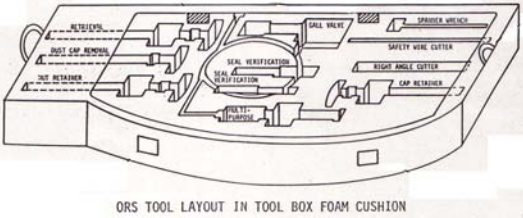
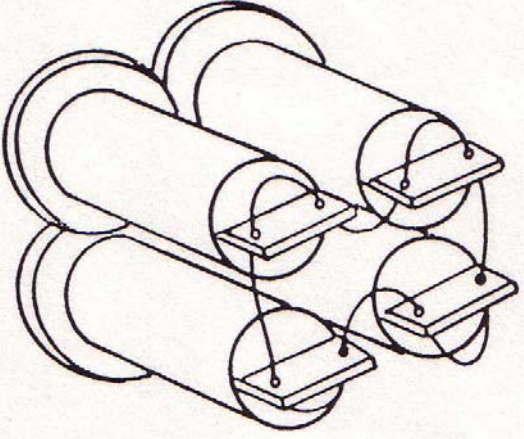
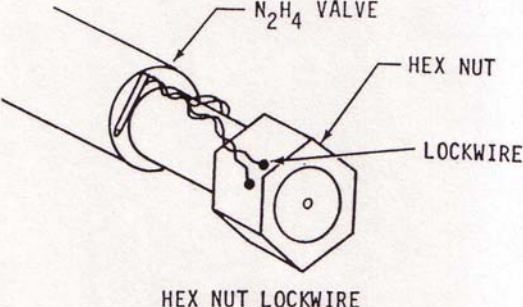
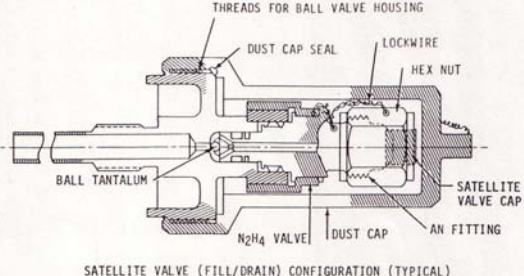
3.1 1981 - Manger

In 1981 Warren Manger and Harold Curtis [72] of RCA Astro-Electronics developed a model to examine the economic tradeoffs affecting the choice of design life and replacement strategy for a system of meteorological satellites. The purpose of the model was to explore the economic possibilities of using the Space Shuttle to retrieve or repair satellites, as opposed to simply replacing them.

The approach here was to find the total normalized cost for each of the options and then to compare them to find which was lower. The model parameters are

shown in Table 3.1. All costs in the study were normalized by dividing each cost by the cost of the launch of one spacecraft on the Shuttle. \$30M (\$1981) was the (optimistic) number used for this purpose. The baseline satellite design life was 2 years. Permutations off of this 2 year design were accommodated by the parameter α . The authors chose a constellation life (H) of 10 years and a constellation size (N) of 3 satellites to represent a planned meteorological satellite system. Operations costs and ground system costs were omitted. Chances of launch failure, deployment failure, docking failure and servicing failure were not addressed.

The normalized cost equation for the retrievable and repairable cases is shown in Equation 3.1. For expendable satellites, the normalized cost model reduces to Equation 3.2. Where the ratio of \bar{C} to \bar{C}_E was less than 1.0, the reuse strategy was deemed superior to the replacement.

$$\bar{C} = N[1 + \gamma(H/L - 1)] + [2.5 + \left\{ \begin{array}{c} \delta \\ 0 \end{array} \right\} + N + N(H/L - 1)(1 - \delta)]\beta\bar{C}_S(L/2)^\alpha \quad (3.1)$$

$$\bar{C}_E = N(H/L) + [2.5 + N(H/L)]\bar{C}_S(L/2)^\alpha \quad (3.2)$$

The behavior of the models were explored and "realistic" values of α, β, γ , and δ were sought. The realism of these parameters is arguable. Figure 3.1 shows a number of \bar{C} and \bar{C}_E plots versus satellite design life for a variety of satellite costs (C_S). This shows that some cost savings from servicing is possible for higher cost, longer life satellites. In Figure 3.2, cost ratio of \bar{C} to \bar{C}_E , repair costs to expendable costs, is plotted and shows that cost savings are possible for higher cost, shorter life satellites.

After exercising the model further, the study concluded that for a benefit to be derived, the spacecraft to be serviced must be "fairly expensive" and the retrieved

\bar{C}	Total normalized cost of launches and spacecraft required for the operational life of the retrievable and repairable systems.
\bar{C}_E	Total normalized cost of launches and spacecraft required for the operational life of the expendable system.
\bar{C}_S	Recurring cost for one of the satellites having a design life of 2 years.
H	Horizon, or lifetime of the overall constellation.
L	Spacecraft design life.
N	Constellation size. This is the number of identical spacecraft which must be in operation simultaneously.
α	Accounts for the cost difference when the design lives other than 2 years are considered.
β	Allows for the extra recurring costs associated with providing the satellite with the capability to be retrieved or repaired in orbit.
γ	Can account for the extra cost for a repair on-orbit operation. Can also reflect the extra costs associated with a launch in which not only is one satellite put into orbit, but one is retrieved.
δ	Fraction of the cost of a new spacecraft which is saved by recovery.

Table 3.1: Parameters for Manger Model

value must be high. Specific thresholds were not identified for either “fairly expensive” or “high.” The authors decided that, for a small constellation of moderately priced satellites, Shuttle based servicing would not present a significant economic benefit.

While this is a useful first order economic evaluation, this study has a number of limitations. Two of the major limits are that the decision model does not include any chance of failure and that a number of arbitrarily valued parameters are included - notably α (design life cost difference), β (recurring costs for retrievable or repairable satellite), γ (on-orbit repair costs or launch costs for the retrievable case), and δ (spacecraft cost saved by recovery). The values used in the study are acknowledged as estimates. Sensitivity analysis for these parameters is included but is not comprehensive.

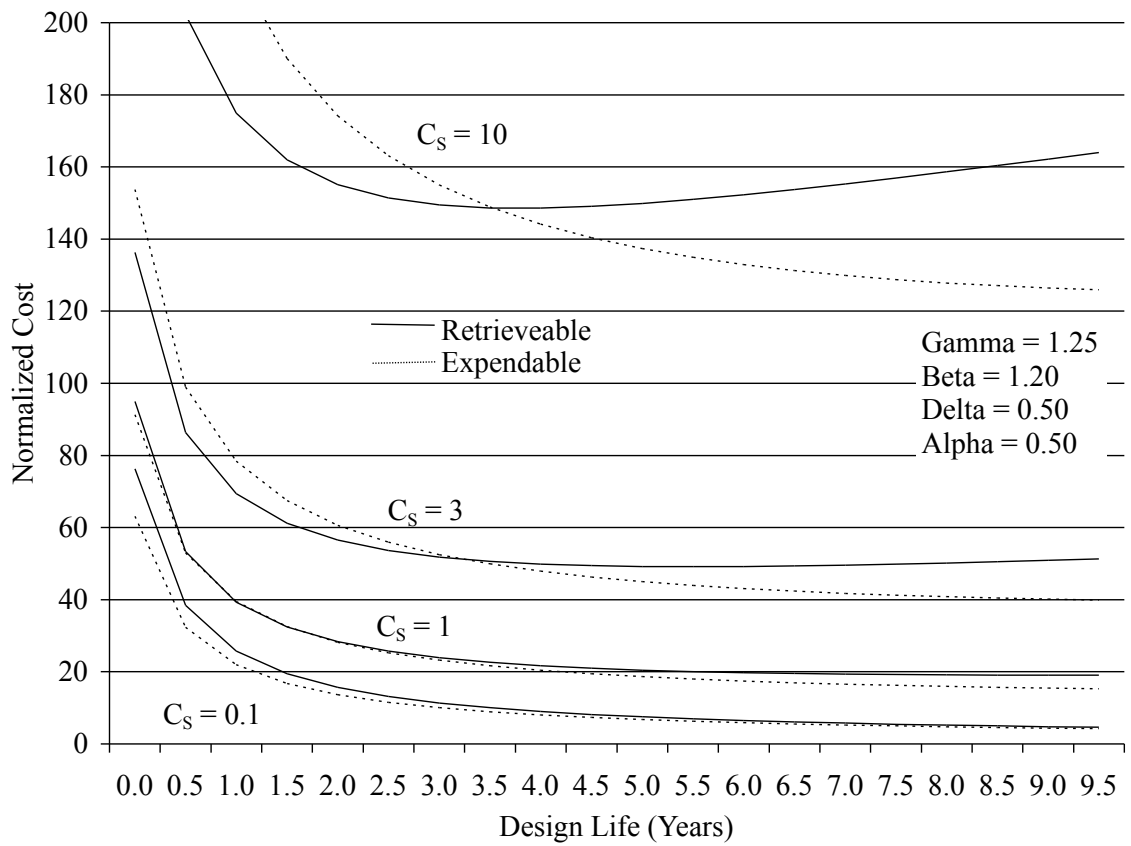

Figure 3.1: Manger Model: Effects Of Basic Satellite Cost (Adapted from [72])

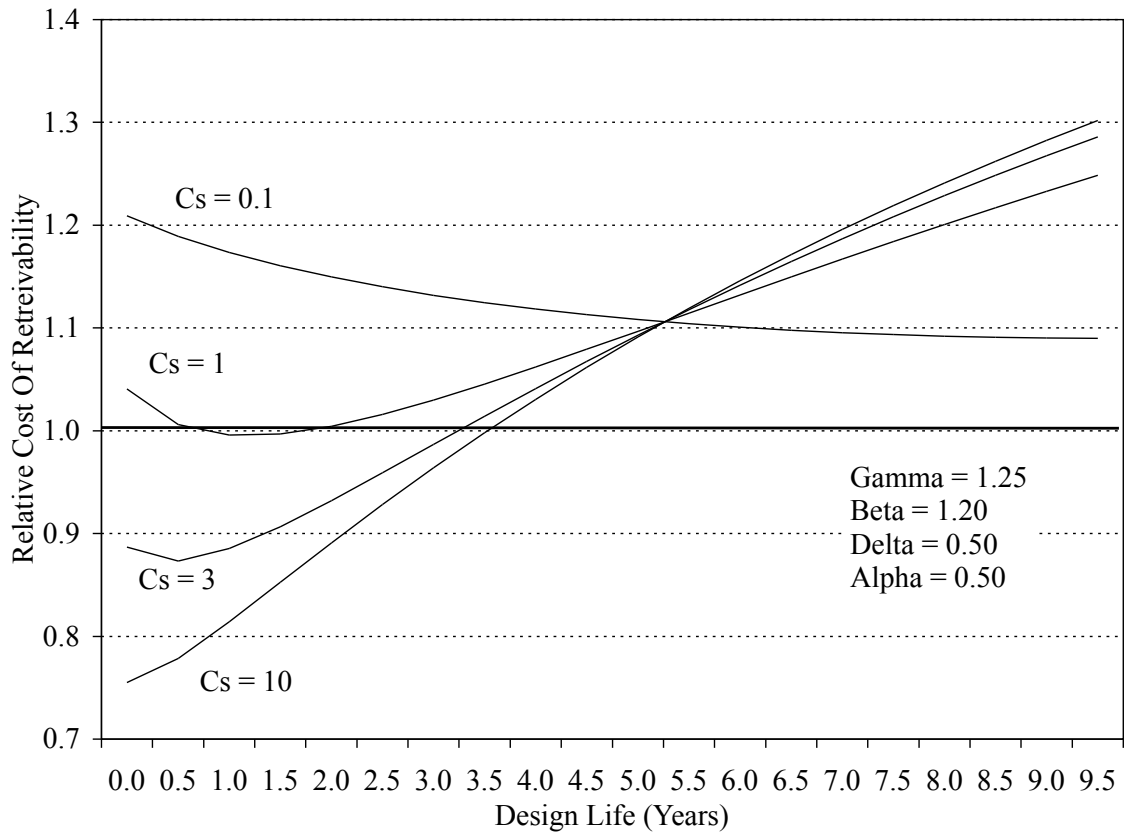

Figure 3.2: Manger Model: Relative Effects Of Basic Satellite Cost (Adapted from [72])

3.2 1981 - Vandenkerckhove

J. A. Vandenkerckhove of ESA published a series of satellite servicing papers in 1981 [100], 1982 [101], and 1985 [102]. They offer useful insights into the satellite servicing problem. The 1981 paper assesses the economics of geostationary satellite services including maintenance, repair, and refueling. The basic profitability equation is shown in Equation 3.3. The components of that equation are further defined in Equations 3.4 thru 3.7. Substituting the values from Table 3.2 into Equation 3.7 yields Equation 3.8, which is the total satellite program cost in terms of just launch and subsystem cost. Cost variables are in Millions of Accounting Units in 1980 prices or MAU(80). 1 MAU(80) is approximately US\$ 1.2M (1980).

$$P = nG - C'_{SER.TOT} \quad (3.3)$$

$$C'_{SER.TOT} = 1.859 \sum (C'_{SS} + C_R) + T' + 8 + C'_{LAUNCH} \quad (3.4)$$

$$G = (c_{REF} - c)M_{PAY.TOT}MTBF \quad (3.5)$$

$$c = \frac{C_{SAT.TOT}}{M_{PAY.TOT}MTBF} \quad (3.6)$$

$$C_{SAT.TOT} = C_{SAT} + C_{TEST} + C_{MANAG} + C_{OPS} + C_{LAUNCH} \quad (3.7)$$

$$C_{SAT.TOT} = 1.859 \sum C_{SS} + T + 8 + C_{LAUNCH} \quad (3.8)$$

This analysis is focused on comparing the costs of servicing versus not servicing (replacement). Actual geostationary communication satellite costs and masses were used as opposes to estimates. A number of servicer configurations (Tankersat, Servicesat, etc.) were evaluated against the model. Some top level conclusions from the 1981 paper:

c	Unit telecommunications cost. Cost of placing and maintaining 1 kg of communications payload in orbit for 1 year.
c_{REF}	Specific cost of reference satellite.
C_{LAUNCH}	Satellite launch cost. Either 39.6 MAU(80) for Ariane-3 or 45.0 MAU(80) for Ariane-4.
C_{MANAG}	Spacecraft management cost. Equals $0.15C_{SAT}$.
C_{OPS}	Spacecraft operations cost. Equals $8 + T$ MAU(80).
C_R	Cost of equipment brought by servicing satellite to serviced satellite.
C_{SAT}	Spacecraft procurement cost. Equals $1.43 \sum C_{SS}$.
$C_{SAT.TOT}$	Total cost of the satellite.
C_{SS}	Cost of all of the satellite subsystems.
C_{TEST}	Spacecraft test cost. Equals $0.15C_{SAT}$.
C'_{LAUNCH}	Launch cost of servicing satellite.
$C'_{SER.TOT}$	Total cost of servicing satellite.
C'_{SS}	Cost of all of the servicing satellite subsystems.
G	Gain per satellite serviced.
$M_{PAY.TOT}$	Total communications payload mass, including dedicated portions of the power and thermal subsystems. (Approx 63% of satellite total mass.)
$MBTF$	Mean Time Between Failures (for satellite)
n	Number of satellites serviced by one servicing satellite.
P	Profitability of servicing a group of satellites.
T'	Lifetime of servicing satellite.

Table 3.2: Parameters for the 1981 Vandenkerckhove Model

- Refueling alone is the most efficient of the possible intervention modes or combinations of modes (refuel, repair, preventive maintenance).
- Refueling appears to be profitable only for large servicing vehicles launched on the Ariane 4 class launch vehicles.
- Refueling appears to be profitable only for long lifetime satellites (about 10 years).
- Advantages from on-orbit refueling would be eliminated by the use of electric propulsion.

Again, chance of failure during either replacement or servicing is not accounted for in the model. Also, the empirical spacecraft costing coefficients have changed with time.

In 1982 Vandekerckhove [101] extended the model to include several factors including satellite mission failure insurance, servicer mission failure insurance, and an on-ground spare satellite factor. Again, the output was profitability with additional relative profitability comparisons. Further design details of a proposed Tankersat servicing vehicle are included.

The 1982 analysis focused entirely on refueling and concluded that the highest potential profitability occurs for a relatively light weight class of geostationary communication satellites with long lifetimes. The author also notes that refueling may be the optimal operational standard for satellites with lifetimes beyond the 10 year mark.

3.3 1985 - Vandekerckhove

Vandekerckhove's 1985 paper [102] lays out a method of comparing the cost-effectiveness of expendable, retrievable, and serviceable spacecraft. It includes a large number of

variables and is used to examine non-revenue generating earth observing systems, micro-gravity science satellites, and other science spacecraft. Equations 3.10, 3.11, and 3.12 show the costing equations for a scientific mission for the expendable, reusable, and serviceable cases respectively. The variables in these equations are defined in Table 3.3. Once again, the approach is to compare the total cost of the serviceable satellites to the expendable satellites and look for situations where servicing is less costly. While the structure of these models has depth and breadth, many of the parameter values are estimates. Launch and other risks are somewhat addressed with the α parameters, however, the values selected are arguable and include no sensitivity analysis.

$$C_{TOT}^{\circ} = (1 + m)(n + 1 + \alpha_L)NC_{SAT}^{\circ} + (1 + \alpha_L)N(C_L^{\circ} + C_l) + \quad (3.9)$$

$$NW + NwL$$

(Expendable Scientific Satellite)

$$C_{TOT}' = (1 + m)\{[n + F^{\lambda} + (N - F)r + N\alpha_L + \quad (3.10)$$

$$(N - F)(1 - r)\alpha_R]C_{PLAT}' + N(n + 1 + \alpha_L)C_{PAY}\} +$$

$$N(1 + \alpha_L)(C_L' + C_l) + (N - F)(C_R' + C_r) + NW + NwL$$

(Reuseable Scientific Satellite)

$$C_{TOT}'' = (1 + m)\{[n + F^{\lambda} + \alpha_L + \alpha_A + \quad (3.11)$$

$$(N - 1)\alpha_S](C_{PLAT}'' + C_{PAY}) + (N - 1)(n + 1)C_{PAY}\} +$$

$$[1 + \alpha_L + \alpha_A + (N - 1)\alpha_S](C_L'' + C_l) +$$

$$(1 + \alpha_A)C_A'' + (N - 1)(C_S'' + C_s) + W + NwL$$

(Serviceable Scientific Satellite)

α_A	In-orbit assembly risk
α_L	Launch risk
α_R	Retrieval risk
α_S	Servicing risk
C_l	Launch operations costs
C_L	Launch costs
C_{PAY}	Payload recurrent costs
C_{PLAT}	Platform recurrent costs
C_r	Retrieval operations costs
C_R	Retrieval costs
C_s	Servicing operations costs
C_S	Servicing costs
C_{TOT}	Total project costs
F	Number of retrievable / serviceable platforms
L	Lifetime or time between flights
λ	Learning curve exponent (nominally 0.926)
n	Non-recurrent to recurrent cost ratio (nominally 2.5)
N	Number of foreseen flights
m	Overhead of procuring agency (nominally 0.12)
r	Relative refurbishment costs
w	Variable operations costs
W	Fixed operations costs
\circ	Superscript for expendable spacecraft
'	Superscript for retrievable / reusable spacecraft
"	Superscript for serviceable spacecraft

Table 3.3: Parameters for the 1985 Vandekerckhove Models

3.4 1989 - Yasaka

Tetsuo Yasaka of NTT has published a number of papers [109], [110], [112], [111] related to satellite servicing and a proposed servicer called GSV (Geostationary Servicing Vehicle). The 1989 study [108] includes an exploration of the economic utility of a number of geostationary spacecraft services, including initial operational monitoring, malfunction recover, health check, and satellite disposal. The approach was to find a relationship between the ratio of the servicing system cost to the satellite cost (C_V/C_S) and the ratio of the servicing gain to the satellite cost (C_G/C_S). The author made a number of simplifying assumptions and derived the linear relationships shown in Equations 3.12 thru 3.15. The variables in these equations are defined in Table 3.4.

These equations include a number of embedded factors such as insurance rate (20%), BOL (beginning of life) failure rate (10%), technical gains (varied by case), delta-v requirement factors, transponder to satellite cost ratios (1.7%), and others. These embedded factors tended to reflect the costs inherent in the point design of the GSV and its assumed target versus a more generally applicable model. Outcomes from this method indicate that economic gains tend to go up with a higher number of servicing visits. Combining missions is also identified as a way to increase potential gain. No threshold to decide if servicing was superior to not servicing was established in the study.

$$\frac{C_G}{C_S} = (0.1r + 0.02 - (1/N)\frac{C_V}{C_S}) \quad (3.12)$$

Initial Operations Monitoring Case)
 “r” is BOL failure rate reduction ratio.

$$\frac{C_G}{C_S} = (r + 0.02 - (3/N)\frac{C_V}{C_S}) \quad (3.13)$$

Malfunction Recovery Case
 “r” is malfunction recovery rate.

$$\frac{C_G}{C_S} = (0.17r + 0.01 - (1/N)\frac{C_V}{C_S}) \quad (3.14)$$

Routine Health Check Case

“r” is gain in transponder-years.

$$\frac{C_G}{C_S} = (0.125r - (2.5/N)\frac{C_V}{C_S}) \quad (3.15)$$

Satellite Disposal Case

“r” is EOL utilization ratio.

C_G	Economical gain in one service mission
C_S	Average customer satellite value
C_V	Service system cost of its life
r	Definition varies by scenario
N	Total number of services given

Table 3.4: Yasaka Model Parameters

3.5 1992 - The INTEC Study

In 1992 NASA and the International Technology Underwriters (now AXA Space space insurance company) conducted a joint study called, “NASA/INTEC Satellite Salvage/Repair Study” [71]. The study examined the salvage and repair market for commercial communications satellites. The two key questions that the study addressed are as follows.

- For each spacecraft in the forecast, at what price does satellite servicing make economic sense?
- Does the distribution of break-even repair costs represent a potential market for a salvage/repair operator?

To answer these questions, the study performed a net present value analysis for each of the current and near-term forecasted satellites in the commercial, defense, and civil markets. The net present value formula is shown in Equation 3.16 and the variables are identified in Table 3.5.

$$NPV = \sum_{t=0}^T \frac{CF_t}{(1+r)^t} \quad (3.16)$$

As Table 3.6 shows the NPV cash flows by year for the replacement case. After a newly launched satellite fails on-orbit, a updated satellite with a higher revenue rate (\$85M versus \$80) is launched after a 3 years of outlays to manufacture and launch

CF_t	Cash flow at time t.
NPV	Net Present Value
r	Discount rate. The cost of capital.
t	Time step index
T	Final time step

Table 3.5: Net Present Value Variables

the replacement satellite. This replacement satellite is assumed to operate for 10 years. A discount rate of 7% is assumed for both this and the servicing case.

Table 3.7 shows the NPV cash flows by year for the servicing case. In the repair scenario a one year repair timeframe is followed by 9 years of operations. The NPV from the replacement scenario was used to back out the break-even cost for the repair mission. In the case shown the break-even TBD cost was found to be \$140M.

Year	1	2	3	4	5	6	7	8	9	10	11	12	13	NPV
Cost	-50	-50	-50											
Revenue				85	85	85	85	85	85	85	85	85	85	
Cash Flow	-50	-50	-50	85	85	85	85	85	85	85	85	85	85	356

Table 3.6: INTEC Satellite Replacement Scenario

This model was used to calculate the break-even repair cost for each of the 58 spacecraft in the commercial communications satellite segment of the forecasted market for 1993 to 1996. The basic analysis showed that 57 of the spacecraft would break-even on a \$50M servicing mission, 49 for a \$100M mission, and 12 for a \$200M mission. The model was also run with and without insurance. It was applied to military and civilian science satellites by using the value of the satellite at launch divided by its nominal lifetime as its quasi-revenue.

Input variables for this model included discount rate, replacement time, satellite life, satellite cost, satellite revenue, and repair time. Additional sensitivity analysis was performed on cost with insurance, cost without insurance, underinsuring, revenue with insurance, revenue without insurance, insurer repayment share, failure rate, differential failure rates, and differential discount rates. The results were, as is

Year	1	2	3	4	5	6	7	8	9	10	11	12	13	NPV
Cost	TBD													
Revenue		80	80	80	80	80	80	80	80	80				
Cash Flow	TBD	80	80	80	80	80	80	80	80	80	0	0	0	356

Table 3.7: INTEC Satellite Repair Scenario

always the case for NPV calculations, very sensitive to the discount rate.

The conclusion of the study was that a satellite salvage and repair business was a marginal proposition. Affiliation with a spacecraft servicing business and participation of the U.S. Government were seen as factors which could improve the probability of success. On the plus side, this study included actual satellite costs and good (direct from industry and proprietary) estimates of future revenues. The downside is the use of NPV with its high sensitivity to discount rate. Actual capital rates were nearly half as much making long term projects more attractive. Also, the model assumes one servicing mission per servicer. While this is reasonable for the rescue of satellites intended for geostationary orbit with a requirement for a powerful upper stage to make up for a low orbit, it is not a good assumption for all servicing scenarios. Additionally, no account is taken of possible servicing or replacement mission anomalies.

3.6 1994 - Newman

In 1994 Lauri Newman completed a master's thesis [77] at the University of Maryland Space System's Laboratory. The central focus of this thesis was the cost effectiveness of on-orbit satellite refueling. The Ranger Telerobotic Flight Experiment (RTFX) robotic servicer, as shown in Table 3.9, launched on a Delta II rocket was the point design chosen for the cost effectiveness study. A satellite refueling economic model was developed to assess various servicing scenarios. The basic equation, Equation 3.17, states that in order for a refueling mission to be cost effective, revenues generated by refueling a target satellite or satellites must exceed the cost of the refueling mission and the cost of continuing to operate the satellites. Geosynchronous communications satellites were used as servicing targets and a very detailed list of the then current ranges of revenue per transponder is included. Non-commercial satellite lifetime gain analysis is included as well.

The parametric model developed captures the key costs and revenues involved in servicing decision analysis. The key equations are shown in Equations 3.18 thru 3.23. Substituting these equations into Equation 3.17 yields Equation 3.25 which shows the component costs and benefits of the servicing scenario. The parameters in these equations are defined in Table 3.8. The model includes MTBFs for the target satellites but does not address any chance of failure during the servicing missions (launch, wrong orbit, operations, etc.). The time value of money is not addressed in the model.

The analysis concluded that it is always profitable to use RTFX to refuel a geosynchronous communications satellite versus replacing it with an identical satellite. Conversely, it found that using a refueled spacecraft until it fails is never more economical than replacing it with an improved technology spacecraft. Of course, these conclusions must be tempered by the fact that this economic evaluation has a point design (Ranger launched on a Delta II) for a servicer built into the calculations. A smaller, more capable servicer would influence the results to be more favorable to servicing.

$$P_T = R_T - C_T \quad (3.17)$$

$$R_T = R_{T_{nR}} + n_t R_t m_t L_{add} \quad (3.18)$$

$$C_T = C_{T_{nR}} + \frac{c_3}{t_{fuel}} L_{add} + C'_T \quad (3.19)$$

$$R_{T_{nR}} = n_t n_{sat} R_t m_t t_{fuel} \quad (3.20)$$

$$C_{T_{nR}} = (c_1 + c_2 + c_3 + c_4) n_{sat} \quad (3.21)$$

$$C'_T = c'_1 + c'_2 + c'_3 \quad (3.22)$$

$$L_{add} = \frac{m_{f_R} t_{fuel}}{m_{f_{sat}}} \quad (3.23)$$

$$P_T = n_t R_t m_t t_{fuel} \left(n_{sat} + \frac{m_{f_R}}{m_{f_{sat}}} \right) - \quad (3.24)$$

$$\left((c_1 + c_2 + c_3 + c_4) n_{sat} + c_3 \frac{m_{f_R}}{m_{f_{sat}}} + c'_1 + c'_2 + c'_3 \right)$$

c_1	Satellite launch costs (\$)
c_2	Satellite costs (\$)
c_3	Satellite operations costs (\$)
c_4	Satellite insurance costs (\$)
c'_1	Servicer launch costs (\$)
c'_2	Servicer costs (\$)
c'_3	Servicer operations costs (\$)
C_T	Cost of servicing scenario (\$)
$C_{T_{nR}}$	Cost of nominal satellite mission (sat, launch, ops, & insurance) (\$)
C'_T	Cost of servicing mission (vehicle, launch, & ops) (\$)
L_{add}	Added lifetime (years)
m_{f_R}	Mass of fuel carried by servicer (kg)
$m_{f_{sat}}$	Mass of maximum satellite fuel capacity (kg)
m_t	Mass of a transponder (kg)
n_{sat}	Number of satellites in family
n_t	Number of transponders per satellite
P_T	Profit of servicing scenario versus baseline scenario (\$)
R_t	Revenue per kg of transponder per year of ops (\$/kg-yr)
R_T	Revenue of servicing scenario (\$)
$R_{T_{nR}}$	Revenue of baseline satellite scenario (\$)
t_{fuel}	Satellite lifetime based on initial fuel load (years)

Table 3.8: Newman Servicing Parameters

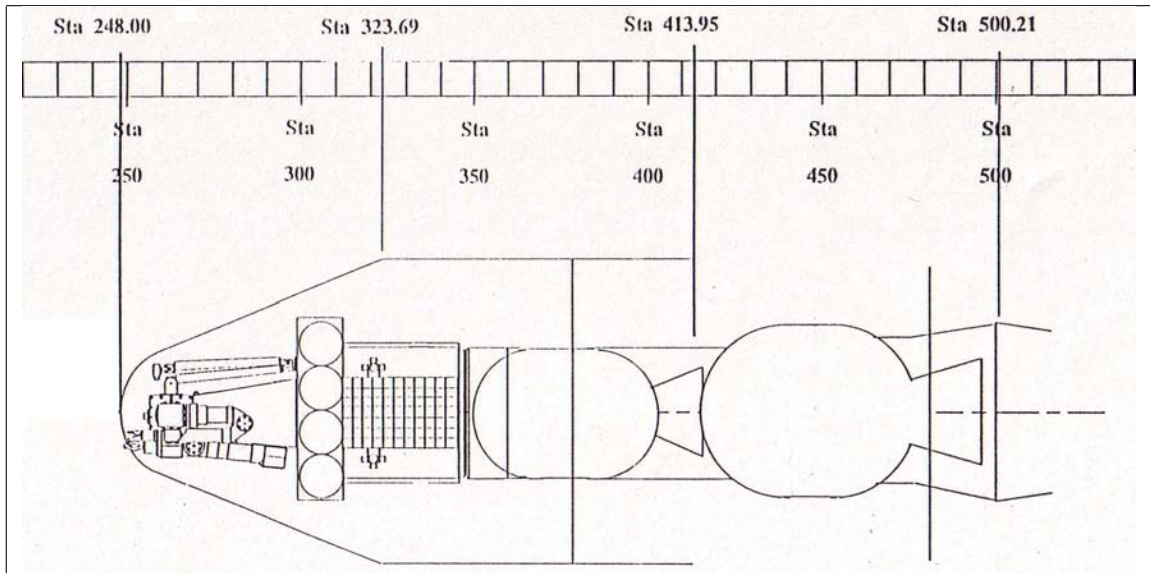

Ranger TFX On Delta II [77]

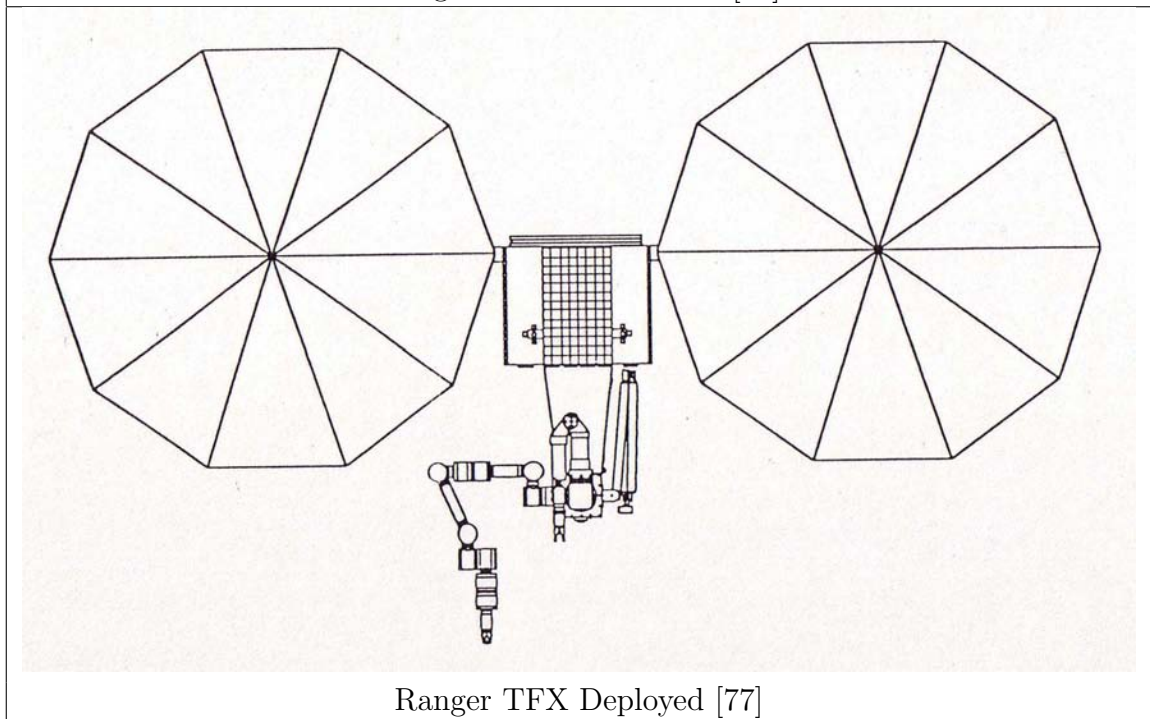

Ranger TFX Deployed [77]

Table 3.9: Ranger TFX Images

3.7 1996 - Hibbard

Hibbard’s 1996 on-orbit refueling assessment [57] includes a review of enabling technologies for on-orbit satellite refueling. The author surveyed the operational lives of US geosynchronous satellites in the 1984 to 1996 timeframe. Based on direct reports from satellite operators, it was determined that the average satellite exceeded its design life by about 3 years and that 52% of satellites experienced fuel related operational impacts with 20% failing due to fuel depletion. Using these observations as motivation for an on-orbit refueling study, a conceptual servicer, the OOR (On-Orbit Refueler) was developed. It is based on the size and configuration of ETS-VII (a NASDA telerobotics demonstration flight) combined with a DSCS-III B satellite (a US military geosynchronous communications satellite). The derived characteristics for the OOR and geosynchronous operational area drive the launch vehicle selection to be a Titan IV class vehicle. The paper uses the USAF Unmanned Space Vehicle Cost Model, 7th edition, to estimate the OOR recurring costs as \$113M.

Equation 3.25 is Hibbard’s basic break even cost equation. The variables are identified in Table 3.10. Hibbard focused on “i,” the number of satellites needed to be refueled per refueling mission to break-even. Based on the values derived from the OOR design, the author determined that a range of 3 to 5 GEO communications satellites must be refueled to make a refueling mission economically feasible. While the analysis does include actual target spacecraft data, the possibility of failure during replacement or servicing missions is not addressed.

$$(R_C + L_C) < \sum ((S_C + L_C)_i \times P_{L\Delta}) \quad (3.25)$$

R_C	Servicer cost
L_C	Servicer launch cost
S_C	Replacement satellite cost
L_C	Satellite launch cost
i	Number of satellites refueled per mission
$P_{L\Delta}$	Percent increase in satellite life

Table 3.10: Hibbard Parameters From Equation 3.25

3.8 1998 - Davinic

Davinic’s 1998 satellite servicing analysis focused on the question of servicing versus replacing sensor equipped satellites in a theoretical LEO constellation. The servicer concept developed is called SMARD (Spacecraft Modular Architecture Design). Comparing costs between various scenarios was accomplished by assessing the present value of the life cycle cost for each scenario. Equation 3.26 shows this standard formula and the parameters are shown in Table 3.11. Additionally, a Monte Carlo simulation was included to address sensor failures and produce a sensor availability metric for each scenario. PVLCC (Present Value of Life Cycle Costs) and sensor availability were the model outputs and give a decision maker a clear trade between cost and sensor coverage. The study concluded that servicing a particular LEO sensor platform is cheaper and enables higher sensor availability than simply replacing failed satellites. The proposed bus is further explored in additional papers by C. M. Reynerson in 1999 [82] and 2001 [83]. A precursor report from NRL was published in 1996 [4].

$$PVLCC = \sum_0^n \left(\frac{1}{(1 + d^{n-1})} \$n \right) \quad (3.26)$$

d	The discount rate
n	The year of the project
$PVLCC$	Present value of life cycle costs (present value of all future expenditures)
$\$n$	The expenditure in a given year in constant year dollars

Table 3.11: Davinic Equation Parameters

3.9 1999 - Leisman

In 1999 Gregg Leisman and Adam Wallen of AFIT produced an extensive study [69] of incorporating on-orbit servicing into the next generation of the GPS fleet. A summary paper was also produced [70]. The study examined 8 servicing architectures including servicers and depots in a variety of orbital locations. While accounting for the life cycle cost of each of the alternatives, the study also incorporated “weights” associated with various aspects of the resulting system. This approach gives a decision-maker the ability to trade life cycle cost versus their own definition of utility (performance, overall program viability, availability, etc.).

The “Value” for each alternative architecture is composed of a sum of different terms with decision-maker supplied weights for each of the terms. Table 3.12 shows the terms, their range values, and their weights in the overall “Value” calculation for the analysis. Each of the terms is developed and analyzed in detail over the course of the analysis. The plot of the values versus mission cost for each alternative is plotted in Figure 3.3. Cost is found using a standard space systems cost estimation tool called NAFCOM [15]. Alternatives with lower price and higher value are more optimal. In other words, the upper left corner (zero cost, value of 10) of the graph would be the most desirable. The circled alternatives indicate the boundary of the desirable options.

Overall, this method is more about deciding which servicing architecture is superior than in deciding to service or not to service. Also, the possibilities of failures during servicing or replacement are not addressed.

Measure	Range	Max. Value	Weight
Cycle Time	0-12 Years	10	0.190
Shared RDT&E	0-1 \$B	10	0.190
3 Or 6 Planes	3 or 6	10	0.143
Capacity	0-230 kg	10	0.143
Multi-Usability	None to High	10	0.143
Upgrade Frequency	0-4 Upgrades	10	0.095
Mean Time To Repair	0-90 Days	10	0.048
Orbit Transfer Capability	None to High	10	0.048

Table 3.12: Leisman Parameters

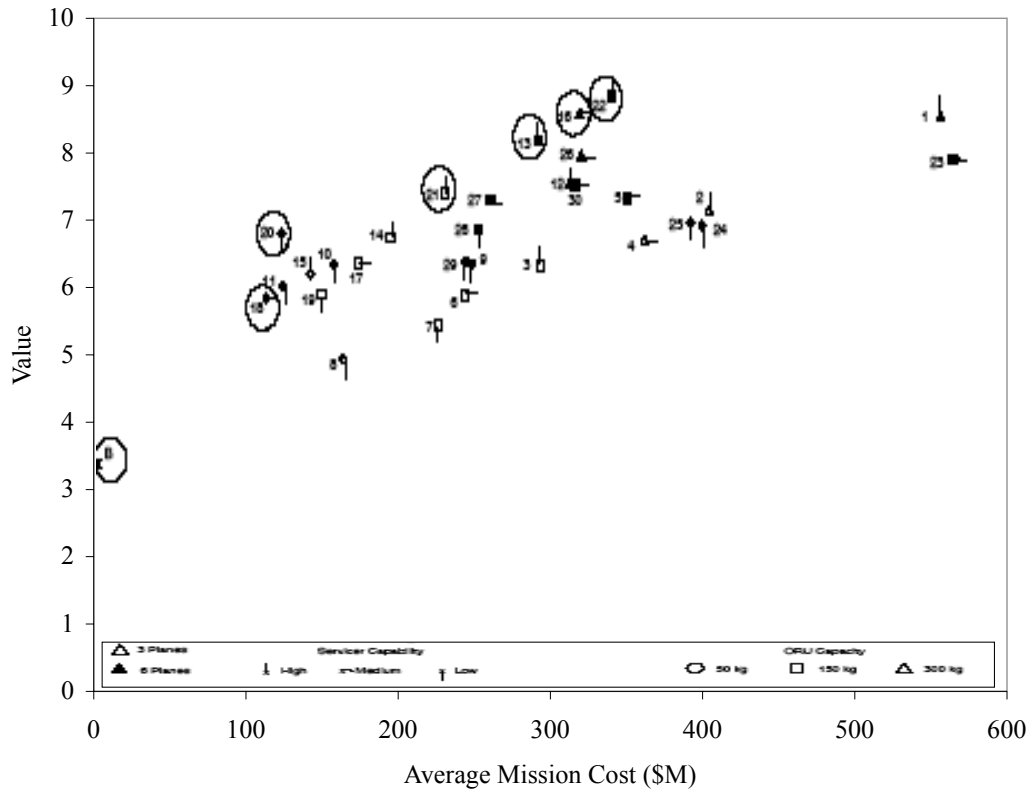

Figure 3.3: Value Of Servicing Architecture Versus Cost (Adapted from [69])

3.10 2001 - Lamassoure

In 2001, Elizabeth Lamossoure completed an MIT thesis titled, “A Framework to Account for Flexibility in Modeling the Value of On-Orbit Servicing for Space Systems [67].” A companion paper was also published [51] shortly thereafter. This analysis seeks to address the uncertainties related to servicing and to establish a value of servicing separately from its cost. The first part seeks to demonstrate the value of having the option to service a spacecraft in orbit in the context of uncertain future revenues. The second part addresses the uncertainty of need for military systems. The utility of reconfiguring a LEO radar constellation is compared to relocating geosynchronous communications satellites. Real options theory, equations for which appear in the next section, is employed and a case for servicing under certain conditions is made.

The model does not appear to include the possibility of failure in either the servicing or replacement operations. A net present value calculation is embedded in the model and leaves it susceptible to the discount rate. Sample calculations are geared towards a small number of actual spacecraft, such as Iridium and Globalstar.

3.11 2002 - McVey

Michelle McVey’s MIT thesis from 2002 [74] is titled, “Valuation Techniques for Complex Space Systems: An Analysis of a Potential Satellite Servicing Market.” A companion paper was also published in 2003 [75]. This analysis also employs real options analysis to assess the viability of servicing. Furthermore, this study seeks to de-couple the servicer and customer sides of the model. A series of baseline missions against typical satellites were costed and cost deltas provided by the option to service were calculated. Viable servicing opportunities were identified. Net present value is included in the evaluation. The Decision Tree Analysis used for dealing with market uncertainty appears to be a form of expected value analysis. A positive result for ser-

ricing geosynchronous communications satellites was found. The the Black-Scholes equation, Equation 3.27, was used to determine the value of options. The associated parameters are shown in Equations 3.28 thru 3.30 and Table 3.13. Values for some of these parameters are not readily available and must be estimated.

$$V_{OPTION} = S_0 \times N(d_1) - e^{-rT_0} \times (E + C_{ops}) \times N(d_2) \quad (3.27)$$

$$N(t) = \int \frac{1}{\sqrt{2\pi}} e^{-t^2} dt \quad (3.28)$$

$$d_1 = \frac{[\ln(S_0/E) + (r + \sigma^2/2) \times T]}{\sigma\sqrt{T_0}} \quad (3.29)$$

$$d_2 = d_1 - \sigma\sqrt{T_0} \quad (3.30)$$

V_{OPTION}	Value of the option of spacecraft life extension
S_0	Present value of revenue stream over life extension
r	Risk free interest rate
E	Cost of servicing
C_{ops}	Operating cost of spacecraft over life extension
T_0	Time of servicing for life extension (i.e. design lifetime of the satellite)
σ	Volatility of the revenues per year of continuously compounded rate of return

Table 3.13: McVey Study (Black-Scholes) Equation Parameters

3.12 2004 - Walton

In Walton's 2004 paper [104], portfolio theory is added to the real options approach to valuation in the presence of uncertainty. The basic equation is shown in Equation

3.32 and the variables are shown in Table 3.14. Again, a number of key parameters must be estimated. The focus in this study is more on whether to design servicing into future satellites versus assessing the economic viability of servicing for current satellites.

$$\begin{aligned}
 &\text{maximize} && r^T w - \frac{k}{2} w^T Q w && (3.31) \\
 &\text{subject to} && \sum_{i=1}^n w_i = 1 \\
 &\text{subject to} && w \geq 0
 \end{aligned}$$

k	Risk aversion coefficient
Q	Covariance matrix
r	Return of an architecture, units vary by mission
w	Investment weightings for architectures

Table 3.14: Walton Equation Parameters

3.13 Other Economic Studies

Additional studies exist which include economic results, but offer even less explanation as to how the conclusions were reached. These studies include SAIC’s “Satellite Servicing Mission Preliminary Cost Estimation Model [1],” “Satellite Servicing: A NASA Report To Congress [2],” James Suttle’s “A Life Cycle Cost Effectiveness Comparison Of Satellite Replacement And Space Repair Strategies [92],” MSFC’s “Satellite Servicing Economic Study [3],” NASA’s “Group Task Force On Satellite Rescue And Repair [98],” and a number of others.

In 1993 Donald Waltz of NASA GSFC published “On-Orbit Servicing Of Space Systems” [105]. This book summarizes the results of work performed by a large number of people in an industry-wide study called SAMS (Space Assembly, Maintenance,

and Servicing). The focus was on national capability, and the study proposed an entire space infrastructure architecture including STS, space station, OMV, FTS, and other components. Satellite servicing was addressed but no details of the cost-benefit assessment method were included. Servicing versus replacement was rated as having savings of 20 to 30% with up to 50% possible.

Additionally, there was an AFIT thesis [50] published by Michael Delpinto in 1988 titled, “Assessing Potential Benefits For Service/Repair And Retrieval Of Satellites: A Pilot Decision Analysis.” An approach to compare replacement, retrieval, and replenishment strategies was formulated, however, the thesis was more focused on developing a method for decision making than arriving at actual results.

Andrew Turner of Space Systems / Loral has developed a series of papers ([94], [93], [95], [96], and [97]) analyzing the possible implications of servicing geosynchronous spacecraft on spacecraft design and launch vehicle utilization. Some intriguing first order economic assessments are included but a detailed analysis is not.

Joseph Saleh’s 2002 MIT dissertation [60] is titled, “Weaving Time Into System Architecture: New Perspectives on Flexibility, Spacecraft Design Lifetime, and On-Orbit Servicing.” Saleh is lead author on a pair of related papers [61] and [62]. This analysis also uses real options analysis based on the Black-Scholes equation shown in Section 3.11. The goal here is to find optimal spacecraft system design life in the presence of both uncertain revenues and the option to extend life via servicing. An additional area of exploration is to shift from economic to utility assessments based on user values.

3.14 Cost Estimation Methods

A number of common spacecraft cost estimation models were used by the various studies. A brief description of these models is shown in Table 3.15. While target

satellite costs and revenues may be obtained from a number of sources, proposed servicing vehicle costs must be estimated. Those studies that did not use the models shown in the table sometimes used costs from a similarly sized existing satellite [57]. An excellent source for information on these and other models is available at the NASA JSC Parametric Cost Estimating Handbook website [29].

#	Model Name	Description
1	NAFCOM	NASA / Air Force Cost Model [15]. Cost estimation based on a database of over 100 military and civil space programs. Public and non-public versions are available in order to protect military program data.
2	USCM	Unmanned Space Vehicle Cost Model (USAF, Space Division, Los Angeles AFB). Intended to estimate total space segment cost including non-recurring and recurring cost of components as well as subsystems for earth orbiting unmanned spacecraft.
3	SSCM	Small Satellite Cost Model (Aerospace Corp.) [68]. The model estimates the development and production costs of a small satellite bus for Earth-orbiting or near-planetary spacecraft.
4	SMAD	SMAD Book (Microcosm) [106]. A set of spacecraft CERs based on the other publicly available models.

Table 3.15: Cost Estimation Models

3.15 Evaluation Of Previous Studies

The question at the start of this chapter remains central. Does the benefit of servicing outweigh the cost? The clearest method appears to be the relatively simple approach at the base of Vandekerckhove (Section 3.2), Newman (Section 3.6), and Hibbard (Section 3.7). In slightly different forms they each attempt to quantify when the financial benefit of servicing exceeds the cost of servicing by focusing on top level, measurable parameters. What then is missing from this approach? Operational uncertainty is not addressed and real world spacecraft data is not assessed in a comprehensive manner. Additionally, some models incorporated a servicer point design into their economic models. These issues are described further in the following subsections.

3.15.1 Operational Uncertainty

The possibility of operational failure in either the replacement or repair scenarios is not addressed by previous studies. While target vehicle on-orbit failures are included in Vandekerckhove [100] and Newman [77], launch anomalies for the servicer or replacement satellite are not. McVey [74] and Saleh [60] include probabilistic decision trees that inspire the need to address these concerns, but their analyses were focused on market uncertainties rather than operational failures. Both a new satellite and a servicer face the significant possibility of a launch failure or other beginning of life anomaly. Servicing operations themselves also include a chance of failure. These alternatives need to be addressed and incorporated into an extended servicing decision model.

3.15.2 Comprehensive Market Assessment

Studies that were focused on making the case for incorporating servicing into the design of new satellites used theoretical satellites as servicing targets. Other studies incorporated small sets of real world satellites. Of the previous studies, Hibbard [57] did the most extensive survey looking at over 100 real world geosynchronous communications satellites. Leisman [69] included GPS satellite information, and Lamassoure [67] used Iridium satellites.

Understanding the various components of the satellite servicing market has not been addressed methodically. An analysis of historical on-orbit failures is needed to assess the failure servicing market. Information such as type of failure, frequency of occurrence of failure type, complexity of the remediation action required, and value of continued operations of repaired satellite need to be determined. For lifetime extension analysis, a survey of current satellites and an assessment of life limiting factors needs to be undertaken.

3.15.3 Decoupling Market Assessment From Servicer Design

An additional issue with the previous methods is that a number of studies (Manger [72], Yasaka [108], Hibbard [57], Newman [77], and Leisman [69]) selected a servicer point design and worked out the economics from there. While this is a useful pathfinder or order of magnitude approach, continually improving servicer technology and improved operational concepts for servicing soon make the conclusions of such models obsolete. A servicing market survey that does not rely on the economic characteristics of one specific servicer design would have broader applicability. McVey [74], Saleh [60], and others have incorporated this idea into their methods. As part of this dissertation, a market assessment of the various segments of the servicing market is included in Chapter 8.

Chapter 4

A New Method To Evaluate Servicing Feasibility

In order to meet the three main shortfalls from the previous efforts (operational failures, comprehensive market survey, and servicer independent assessment), a number of steps were taken. The comprehensive market survey was conducted by developing databases on nominal satellite characteristics and of on-orbit failures. Descriptions of these two databases may be found in Chapter 5. Analysis of the servicing opportunities derived from these databases follows in Chapter 7.

To address the significant chance of operational failure in both servicing and non-servicing scenarios, a new method to evaluate satellite servicing feasibility is introduced in the following sections of this chapter and developed in detail in Chapter 8. Briefly put, the new method is based on the basic approach identified by Vandekerckhove , Newman, and Hibbard, and is extended by incorporating the expected value method to address operational uncertainty.

4.1 Previous Servicing Decision Method

The previous method, from Vandekerckhove [100], Newman [77] and Hibbard [57], can be expressed as Equation 4.1 with parameters defined in Table 4.1. This is a simplified form ignoring, for now, the time value of money and rolling the launch, operations, and other costs into the parameters shown.

$$vExtendedLife - cSvcMsn > vNewSat - cNewSat \quad (4.1)$$

$vExtendedLife$	Value of the extended life for the serviced Sat
$cSvcMsn$	Cost of the servicing mission
$vNewSat$	Value of the life of a replacement spacecraft
$cNewSat$	Cost of deploying the replacement spacecraft

Table 4.1: Parameters From Equation 4.1

Implicit in this formulation is that the chance of launch failure for the servicer or the replacement satellite is zero. Also, the chance of the servicing mission failing is zero. As will be shown in Chapter 7, the chance of any given launch to fail is about 4.8% over the last 10 years. Clearly, this and other operational uncertainties must be addressed to formulate any meaningful comparison. One way to accommodate the chance of failure is to recast the problem in expected value form.

4.2 Expected Value Method

As seen in [48], [52], and [45], the basic expected value equation is shown in Equation 4.2 and the parameters are shown in Table 4.2. Figure 4.1 illustrates that the method can be used to find the value of different branches of a decision tree. Each outcome has its own value and probability of occurring. For Option A in the figure to be selected (have the highest expected value), Equation 4.3 would need to be true. Adaptation of this method to address operational uncertainty in servicing and non-servicing scenarios is shown in the next section.

$$EV = \sum_i x_i P(x_i) \quad (4.2)$$

$$x_{A1}P(x_{A1}) + x_{A2}P(x_{A2}) + x_{A3}P(x_{A3}) > x_{B1}P(x_{B1}) + x_{B2}P(x_{B2}) \quad (4.3)$$

EV	Expected value
i	Event
$P(x_i)$	Probability that event i will occur
x_i	Value of event i

Table 4.2: Expected Value Equation Parameters

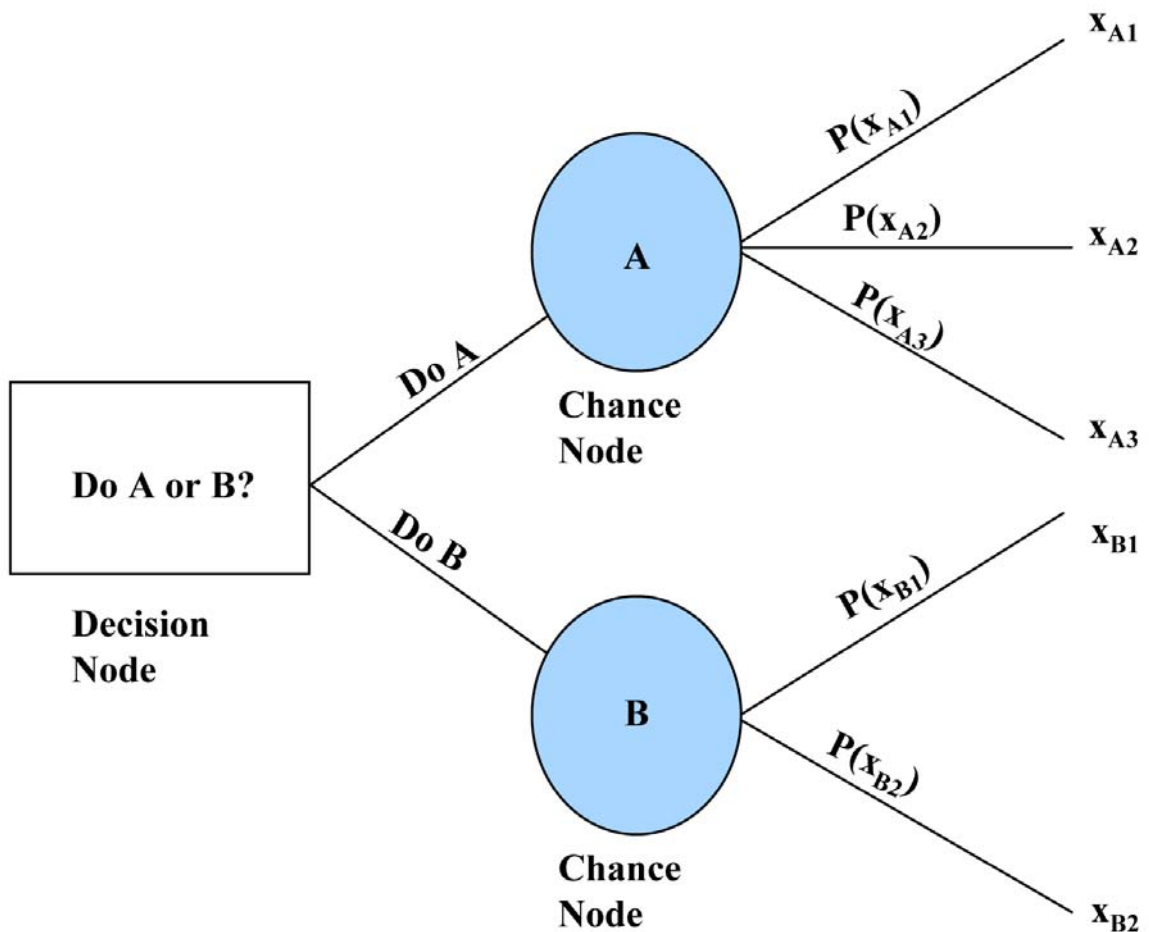

Figure 4.1: Expected Value Method

4.3 New Servicing Decision Method

A simplified servicing decision tree is shown in Figure 4.2. The expected value equation for this diagram is Equation 4.5. Introducing a break-even servicing fee, $vSvcFee$, allows the conversion of the inequality to the form shown in Equation 4.6. This break-even servicing fee represents the maximum amount a proposed servicer could charge for the net value of the mission to be zero. Obviously, the lower this servicing fee is, the more attractive servicing becomes.

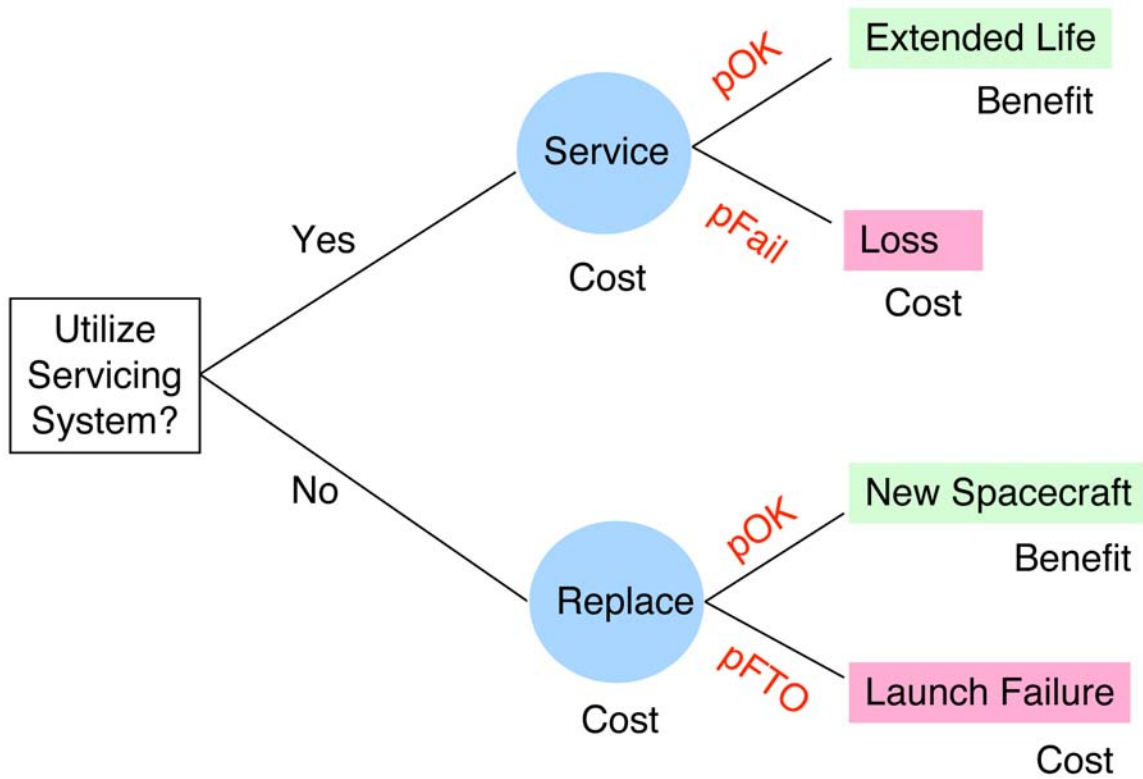

Figure 4.2: Expected Value Diagram For Servicing

$$\begin{aligned}
 (pOK \times vExtendedLife - pFail \times cSvcMsn) &> & (4.4) \\
 (pOK \times vNewSat - pFTO \times cNewSat)
 \end{aligned}$$

$$vSvcFee = (pOK \times vExtendedLife - pFail \times cSvcMsn) - \quad (4.5)$$

$$(pOK \times vNewSat - pFTO \times cNewSat)$$

The above serves only as an example of the intended approach. The expected value break-even servicing fees for each of the servicing markets identified in Chapter 7 are developed in detail in Chapter 8 using the above method. The method is also demonstrated against a proposed servicer in Chapter 9.

4.4 Satellite Information Required For New Method

In order utilize this new method, a variety of spacecraft information is required. Key parameters from the detailed development in Chapter 8 are collected in the Satellite Information Database described in the next chapter. Aggregation and analysis of this real world data is critical to provide a servicing feasibility assessment rooted more firmly in reality than previous studies.

Chapter 5

Database Development

One common shortcoming of the economic models examined in the previous chapter is the lack of spacecraft technical and economic details to evaluate the claims. In response to this, a detailed survey of satellites, launch vehicles, upper stages, and on-orbit failures is needed. While various types of satellite information are available from diverse sources, no single available database includes all of the information needed to assess the technical and economic feasibility of satellite servicing.

Evidently a number of proprietary spacecraft failure databases exist. The Aerospace Corporation, the Teal Group, Futron, and other organizations have released some summaries of on-orbit failures. However, none of these databases are available for public use at this time. Therefore, a satellite information database and an on-orbit failure database were developed for use in this analysis.

Descriptions of the satellite and on-orbit failure databases are presented in this chapter. A summary of the records and fields in both are shown in Table 5.1. The databases include information from the beginning of spaceflight in 1957 through the end of 2003. The “Records” column corresponds to satellites and the “Fields” column indicates the maximum number of attributes collected per satellite.

Database	Records	Fields
Spacecraft Information	6,032	139
On-Orbit Spacecraft Failures	854	54

Table 5.1: Databases

5.1 Spacecraft Information Database

The spacecraft database includes launch information, spacecraft bus parameters, transponder counts, launch costs, spacecraft costs, and other satellite specific information. Orbital information from a variety of sources and epochs is also included. The primary source for orbital information was the NASA/GSFC Orbital Information Group Web Site [26]. Each database record includes references to the sources from which it was derived.

5.1.1 Spacecraft Identification Scheme

The many sources used to develop the satellite information database used a variety of means to identify satellites. The COSPAR international identifier was used by many of the data sources. Other sources used the NORAD identifier. Still others used only the satellite name, which varied widely.

Either the NOARD or COSPAR identifier could have been used. Because the COSPAR identifier includes launch year information and was in wider use, it was selected as the basis for the unique identifier for this satellite information database. However, with both NORAD and COSPAR there is no standard identification scheme for launches that failed to orbit. Nor is there a standard method to call out payloads that failed to separate. “Failed to separate” payloads are those that inadvertently remained attached to their upper stages or that failed to separate from co-manifested payloads. To meet all of these needs, the COSPAR augmented identification schemes shown in Table 5.2 and Table 5.3 were adopted.

Sample ID	Meaning
1900-001A	Successful Launch, Payload A (Standard COSPAR Identifier)
1900-001A.01	Successful Launch, Payload Failed to Separate, Payload Component 01
Where	
1900	Launch Year
001	Launch identifier
A	Payload identifier
.01	Payload Component identifier

Table 5.2: Identification Scheme For Successful Launches

Sample ID	Meaning
FTO-1900-12-01	Single Payload Failed To Orbit
FTO-1900-12-01.01	Multiple Payload Launch Failed To Orbit
FTO-1900-12-01A	Multiple Rockets With Single Payloads Failed on same date
FTO-1900-12-01A.01	Multiple Rockets With Multiple Payloads Failed on same date
Where	
FTO	Failed To Orbit
1900	Launch Year
12	Launch Month
01	Launch Day
A	Differentiates rockets that failed on the same launch date
01	Identifier for payloads that failed to separate

Table 5.3: Identification Scheme For Missions That Failed To Orbit

5.1.2 Sources

The satellite information database was constructed from a number of open sources. These are shown in Table 5.4. This table shows the source, the year of the earliest information, the year of the latest information, the number of records, and the number of fields. Additional sources, [47], [76], [103], [107], and [30], were used to cross check in a number of cases. The databases include all civilian, military, commercial, and non-governmental organization spacecraft launched from 1957 through 2003. A number of United States and Russian military reconnaissance related sub-satellites were

omitted because they were thought to be re-entry capsules containing reconnaissance film canisters or small, short lived auxiliary spacecraft.

	Source	Ref	Earliest	Latest	Records	Fields
1	Aerospace Source Book	[78]	1984	2003	672	23
2	Celestrak Satellite Catalog	[64]	1957	2003	5,383	7
3	Hibbard	[57]	1976	1990	125	14
4	Hughes	[8]	1963	2000	195	11
5	Intelsat	[10]	1980	1998	30	15
6	Isakowitz	[59]	1965	1999	2,967	21
7	Jonathan's Space Report	[73]	1957	2003	6,407	11
8	Mission Spacecraft Library	[6]	1957	1997	5,107	19
9	NSSDC Master Catalog	[11]	1957	2003	5,604	16
10	PanAmSat	[12]	1985	2000	22	17
11	Satellite Today Database	[7]	1980	2000	247	8
12	AGI Spacecraft Digest	[13]	1960	2003	2,375	24
13	The Satellite Encyclopedia	[14]	1992	2003	2,251	64

Table 5.4: Satellite Database Sources

5.1.3 Fields

Tables 5.5 through 5.13 list and briefly describe the fields included in the satellite information database. Additional fields consisting of calculations based on these data fields are also included in the database. A sample satellite record is shown in Appendix H.

#	Field	Description
1	Joint IntID	Identifier for satellite. Key field.
2	Joint Name	NSSDC satellite name
3	Joint Launch Date	Launch Date
4	Joint NORAD	NORAD identification number
5	SvcDB	Type of satellite
6	GeoDB	Type of geosynchronous satellite
7	Program	If satellite is part of a program of satellites
8	Block	Geographic region of satellite country
9	Satellite Name	Cleaned up satellite name
10	AKA1	Satellite also known as
11	AKA2	Satellite also known as
12	AKA3	Satellite also known as
13	AKA4	Satellite also known as
14	Acronym	Explanation, if the satellite's name is an acronym
15	Operator	Satellite operator, owner, or organization
16	Country	Country of operator
17	Original Country	Country of original operator, if satellite has been sold

Table 5.5: Satellite Database Fields - ID Related Fields

#	Field	Description
1	Mkt	Market: Commercial, Military, Civilian, NGO
2	Msn1	Mission: Comm, Sci, Tech, etc.
3	Mission1	More mission info
4	Msn2	Mission: Comm, Sci, Tech, etc.
5	Mission2	More mission info
6	Human Space Flight	Indicates spacecraft used in human space flight
7	Crew (Up/Dn)	Number of crew at launch and landing
8	Crew at Launch	Names of crew at launch
9	Deployed by / Released	Name of delivery spacecraft if released on-orbit
10	Firsts / Lasts	Historical notes
11	Short Mission Description	Brief mission description
12	Long Mission Description	Longer mission description

Table 5.6: Satellite Database Fields - Mission Related Fields

#	Field	Description
1	Launch Vehicle	Launch vehicle
2	Payload Year	Payload launch year
3	Launch Year	Unique launch identifier. Only 'A' payloads
4	Launch Site	Launch site
5	Upper Stage	Upper stage

Table 5.7: Satellite Database Fields - Launch Related Fields

#	Field	Description
1	Launch Mass (kg)	Payload mass at launch
2	Spacecraft Bus	Name of standard spacecraft bus
3	Manufacturer	Satellite prime manufacturer
4	Xenon Propulsion	Indicates ion propulsion system
5	Dimensions	Spacecraft dimensions
6	Est In Orbit Mass (kg)	Estimated mass in orbit
7	Est Dry Mass (kg)	Estimated spacecraft dry mass
8	Est Life Fuel Mass (kg)	Estimated fuel mass
9	In Orbit Mass (kg)	Reported initial spacecraft mass in orbit
10	Dry Mass (kg)	Reported spacecraft dry mass
11	Fuel Mass (kg)	Reported spacecraft fuel mass
12	DC Power (W)	Spacecraft power, typically at beginning of life
13	Solar Array Config	Solar array description
14	Stabilization	Type of stabilization: 3-axis, spin, etc.
15	NukeDB	Indicates if spacecraft had nuclear power source

Table 5.8: Satellite Database Fields - Spacecraft Related Fields

#	Field	Description
1	Actual Duration (days)	Spacecraft life in days
2	Actual Life (yrs)	Spacecraft life in years
3	Design Lifetime (yrs)	Reported spacecraft design life in years
4	Est Design Lifetime (yrs)	Estimated spacecraft design life in years
5	Est EOL	Estimated end of life
6	Status	Spacecraft status: active, inactive
7	Status Date	Date status reported
8	Decay Date	Date spacecraft impacted planet

Table 5.9: Satellite Database Fields - Lifetime Related Fields

#	Field	Description
1	Est Sat Cost (\$M)	Estimated spacecraft manufacturing cost
2	Est Launch Cost (\$M)	Estimated spacecraft launch cost
3	Total Cost (\$M)	Total spacecraft cost
4	Sat Cost (\$M)	Reported spacecraft manufacturing cost
5	Launch Cost (\$M)	Reported spacecraft launch cost
6	Insurance Cost (\$M)	Reported insurance premium
7	Insured Amount (\$M)	Reported insurance level

Table 5.10: Satellite Database Fields - Financial Related Fields

#	Field	Description
1	Orbit Loc	Satellite location: FTO, EOR, BEO, DEC
2	Intended Orbit	Intended orbit
3	Orbit	Actual orbit
4	Missed Orbit	Indicates spacecraft not delivered to correct orbit
5	Inc (deg)	Inclination of spacecraft orbit
6	Perigee (km)	Perigee of orbit
7	Apogee (km)	Apogee of orbit
8	Period (min)	Period of orbit
9	Epoch	Date of orbital elements
10	Orbit Info Source	Source of orbital elements
11	e	Eccentricity of the orbit
12	RAAN (deg)	Right angle of ascending node of the orbit
13	ArgPer (deg)	Argument of perigee of the orbit

Table 5.11: Satellite Database Fields - Orbit Related Fields

#	Field	Description
1	Date in GEO	Date satellite reached GEO
2	GEO Long (deg)	Geosynchronous Longitude
3	Drift (deg/day)	Rate of drift in GEO orbit

Table 5.12: Satellite Database Fields - GEO Related Fields

#	Field	Description
1	Total Xpndr	Total number of transponders on a GEO satellite
2	C-band Xpndr	Total C-band transponders
3	C-band BW	Bandwidth per transponder in MHz
4	Ka-band Xpndr	Total Ka-band transponders
5	Ka-band BW	Bandwidth per transponder in MHz
6	Ku-band Xpndr	Total Ku-band transponders
7	Ku-band BW	Bandwidth per transponder in MHz
8	L-band Xpndr	Total L-band transponders
9	L-band BW	Bandwidth per transponder in MHz
10	S-band Xpndr	Total S-band transponders
11	S-band BW	Bandwidth per transponder in MHz
12	X-band Xpndr	Total X-band transponders
13	X-band BW	Bandwidth per transponder in MHz
14	Coverage	Area of communications coverage

Table 5.13: Satellite Database Fields - GEO Communications Related Fields

5.2 Database of On-Orbit Spacecraft Failures

On-orbit spacecraft failure information was collected from a number of sources as shown in Section 5.2.2. The failures database includes failure type, date, level, description, insurance claim, and other related details. To focus subsequent analysis on probable candidates for servicing, a number of spacecraft failures were omitted. Omitted types of spacecraft include those that failed to achieve orbit, spacecraft beyond earth orbit, spacecraft involved in human spaceflight, ASAT military spacecraft, FOBS military spacecraft, spacecraft that exploded on-orbit, military reconnaissance sub-satellites, amateur radio satellites, space burial payloads, spacecraft mass simulators, passive radar calibration targets, and low mass, low cost experimental spacecraft.

5.2.1 Failures Identification Scheme

While launches and payloads are unique events, payloads themselves can suffer multiple failures leading up to total failure. For this satellite failures database an additional suffix was added to the satellite identifier to indicate failure events in chronological order. An example of this scheme is shown in Table 5.14.

Sample ID	Meaning
1900-001A#2	Successful Launch, Payload A, Failure Event #2
1900-001A.01#2	Successful Launch, Payload Failed to Separate, Payload 01, Failure Event #2
Where	
1900	Launch Year
001	Launch identifier assigned
A	Payload identifier assigned
01	Identifier for payloads that failed to separate
#2	Failure event number (chronological)

Table 5.14: Identification Scheme For On-Orbit Failure Events

5.2.2 Sources

The on-orbit failures database was constructed from a number of open sources. These are shown in Table 5.15. This table shows the source, the year of the earliest information, the year of the latest information, the number of records, and the number of fields.

	Source	Ref	Earliest	Latest	Records	Fields
1	Aerospace Source Book	[78]	1998	2003	31	14
2	Dowa Insurance	[5]	1984	1996	24	7
3	Encyclopedia Astronautica	[103]	1958	2003	453	19
4	Group Task Force Report	[98]	1970	1991	47	8
5	INTEC Study	[71]	1980	1990	22	7
6	Isakowitz	[59]	1958	1999	346	9
7	ISIR	[99]	1993	1999	85	7
8	Satellite Encyclopedia	[14]	1991	2003	295	10
9	Satellite News Digest	[30]	1991	2003	26	13
10	Stockwell	[90]	1977	1988	26	9
11	Waltz	[105]	1977	1988	16	7

Table 5.15: On-Orbit Failures Database Sources

5.2.3 Fields

The on-orbit failure database contains a number of fields, including those shown in Table 5.16. A sample of a failure record is shown in Appendix H.

#	Field	Description
1	Event ID	Unique identifier for event. IntID with chronological sequence number appended
2	Sequence	Chronological sequence number of event for satellite
3	Joint IntID	Unique identifier for satellite. Link to Satellite Information Database
4	FailDB	Serviceable Failure Indicator
5	Failure Year	Year of failure
6	Prefail Life (Days)	Days from initial operations to failure event
7	Prefail Life (Years)	Years from initial operations to failure event
8	Total Life (days)	Total satellite operational life in days
9	Total Life (yrs)	Total satellite operational life in years
10	Beyond EOL (Years)	Years past design life that failure event occurred
11	Era	Era of failure: BOL (beginning of life), NomOps (nominal operations), EOL (beyond end of design life)
12	Event Date	Date of anomaly
13	Fail To EOL Days	Time from failure event to end of life in days
14	Simple Failure Level	Total or Partial failure
15	Failure Level	Level of failure (more distinctions)
16	Event Type	Type of anomaly
17	Service Required	Service required to mitigate failure
18	If ORUable	ORU in component failure
19	Affected System	System where failure occurred
20	Other Svc	Difficult failure type
21	Difficult Service	Indicates if unknown or difficult failure occurred
22	Post Event Stability	Spacecraft attitude - stable or tumbling
23	Brief Failure Description	Brief description of the failure event
24	Failure Description	Description of the failure event
25	Failure Source	Source of failure: L/V (launch vehicle), S/C (spacecraft bus), P/L (payload on spacecraft), U/S (upper stage)
26	Salvage Note	Describes response to failure. i.e. used lifetime fuel to reach correct orbit
27	Then Value (\$M)	For uninsured satellites, combined satellite and launch cost in then year dollars
28	2003 Conv	BLS inflation rate
29	Life Ratio	Percent of design life lost
30	Loss Value (\$M)	Value of loss in 2003 Dollars

Table 5.16: Failures Database Fields

Chapter 6

Satellite Trends

The development of the databases in Chapter 5 enables the exploration of a number of avenues of analytical inquiry. The frequency, severity, and economic impact of on-orbit satellite failures may be determined. Opportunities for satellite lifetime extension can also be examined. These and other servicing opportunities are addressed in detail in Chapter 7. Beyond failure and lifetime extension analysis, other satellite trends can be extracted from the Satellite Information Database. The following sections illustrate the type of information available by examining various key characteristics of geosynchronous communications spacecraft.

6.1 Commercial Geosynchronous Communications Satellites

Figure 6.1 shows the number of new, retiring, and net number of active commercial geosynchronous satellites. While the launch rate has declined in recent years, there has not been a year with fewer active satellites than the previous year since 1986.

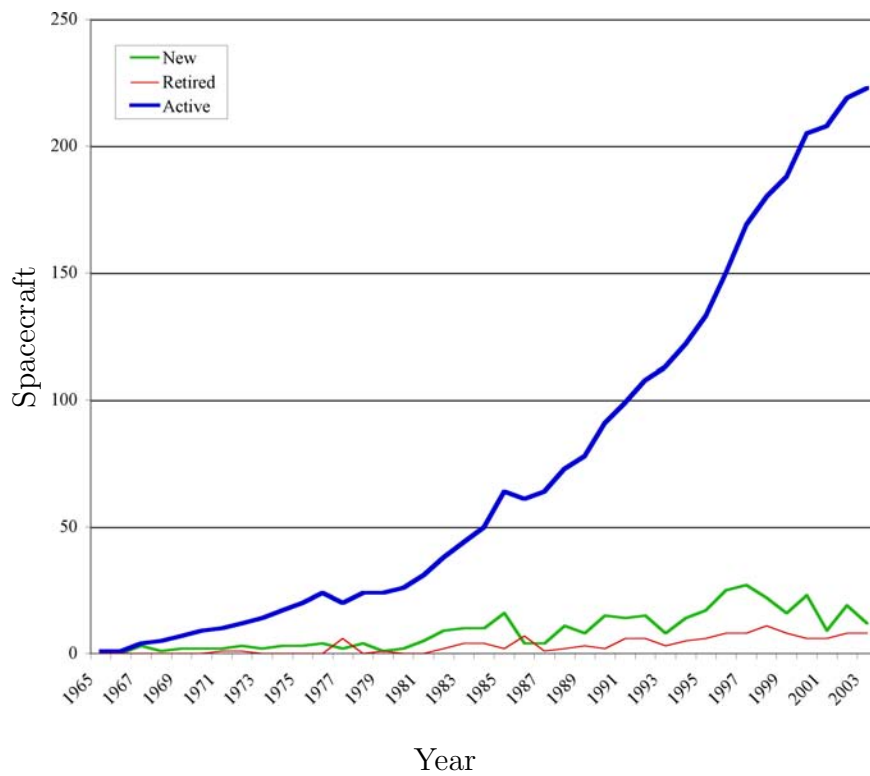

Figure 6.1: Active Commercial GEO Spacecraft

6.2 Transponders Per Commercial Geosynchronous Communications Satellite

Figure 6.2 shows the average transponder count on active geosynchronous commercial communications satellites. There has been a steady increase in the number of transponders per satellite barring a plateau in the 1980s.

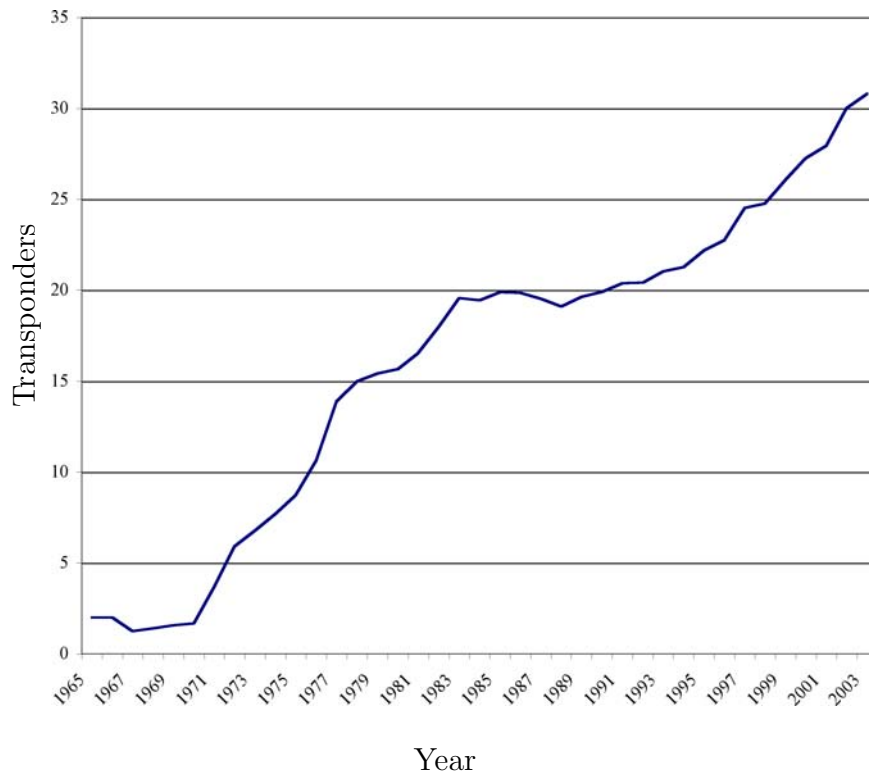

Figure 6.2: Average Transponder Count On Active Geostationary Commercial Satellites

6.3 Total Commercial Geosynchronous Communications Satellite Transponders

Figure 6.3 shows the total worldwide transponder count available from active geosynchronous commercial communications satellites. There has been a steady and steep increase in the total number of transponders barring a dip in the late 1980s. This figure demonstrates a continuing strong demand for transponders in geosynchronous orbit.

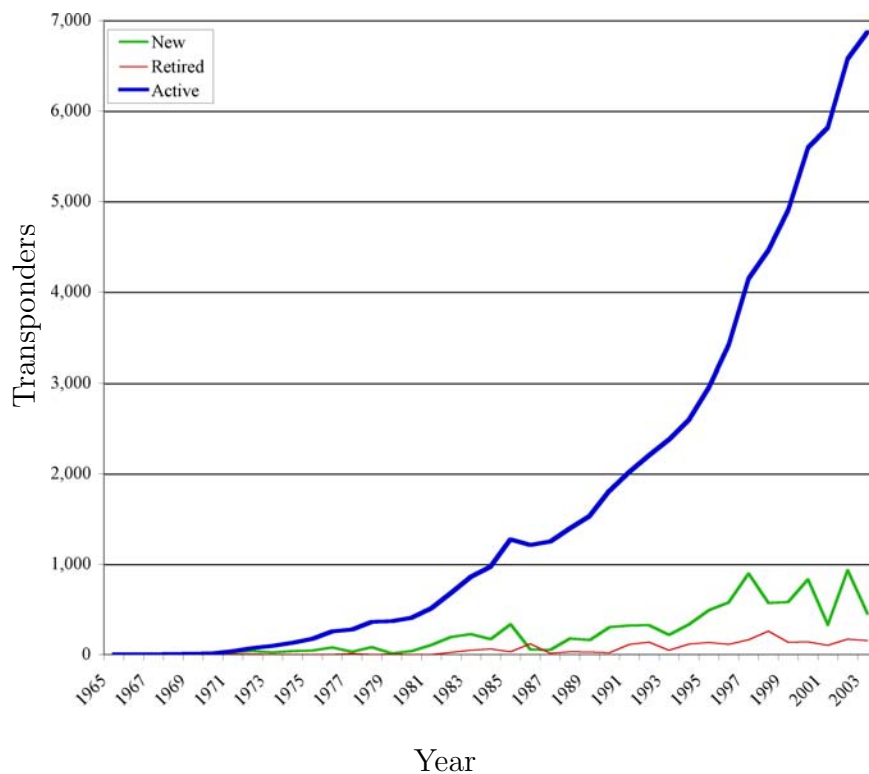

Figure 6.3: GEO Spacecraft Commercial Transponder Capacity

6.4 Bandwidth Per Transponder

Figure 6.4 shows the minimum, maximum, and average bandwidth (in MHz) of C-band transponders on satellites launched over the twenty year period from 1984 to 2003. Data is available back to the first commercial geosynchronous communications satellite (Intelsat 1) launched in 1965, but in the interest of legibility only the last 20 years are presented here. This information is collected from 182 spacecraft. Additional C-band payload satellites were launched but the bandwidth of their transponders was not reported. Note that no C-band payloads were reported in 2001. Surprisingly, the capacity of the average transponder is not increasing with time. However, as seen in Figure 6.2, the transponder count per satellite is increasing, yielding an effective increase in bandwidth capacity per satellite.

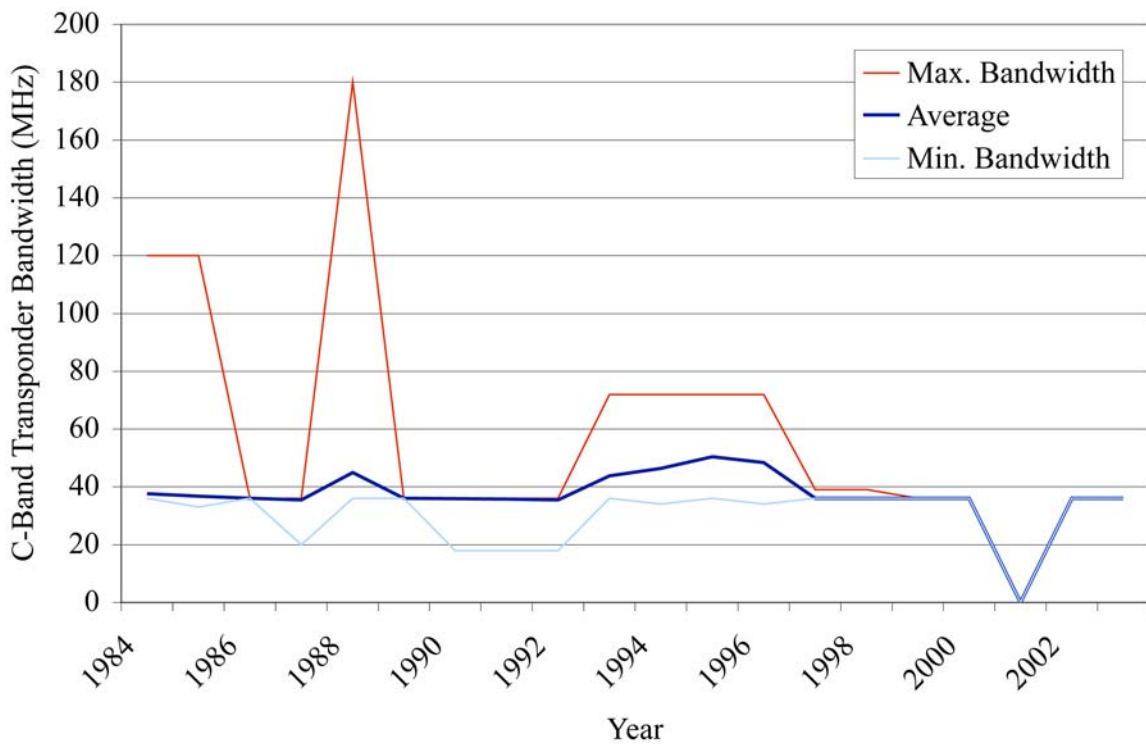

Figure 6.4: C-band Transponder Bandwidth By Year, 1994 To 2003

Figure 6.5 shows the minimum, maximum, and average bandwidth (in MHz) of Ku-band transponders on satellites launched over the twenty year period from 1984 to 2003. This information is collected from 238 spacecraft. Additional Ku-band payload satellites were launched but the bandwidth of their transponders was not reported. Again, the capacity of the average transponder is not increasing with time.

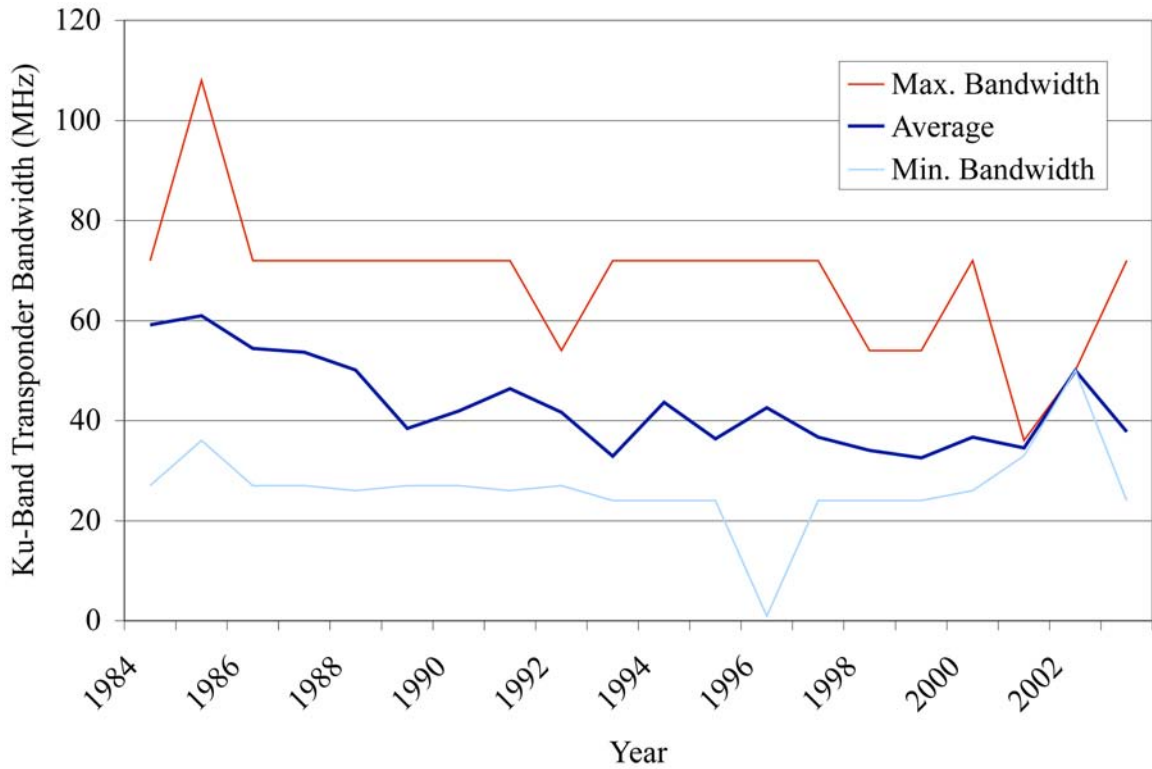

Figure 6.5: Ku-band Transponder Bandwidth By Year, 1994 To 2003

6.5 Stabilization Of Commercial Geosynchronous Communication Satellites

Figure 6.6 shows the stabilization method of the active commercial geosynchronous communication satellites for the twenty year period from 1984 to 2003. Note the steady increase in 3-axis stabilized spacecraft versus spin stabilized. The cross over point occurred in 1986. This chart shows that the 3-axis satellites outnumber the spin stabilized ones at a ratio of over five to one. This stabilization is important to servicing because it strongly affects the docking approach. Docking and servicing either is feasible, but is much less difficult for the 3-axis spacecraft because of the much lower rotation rates.

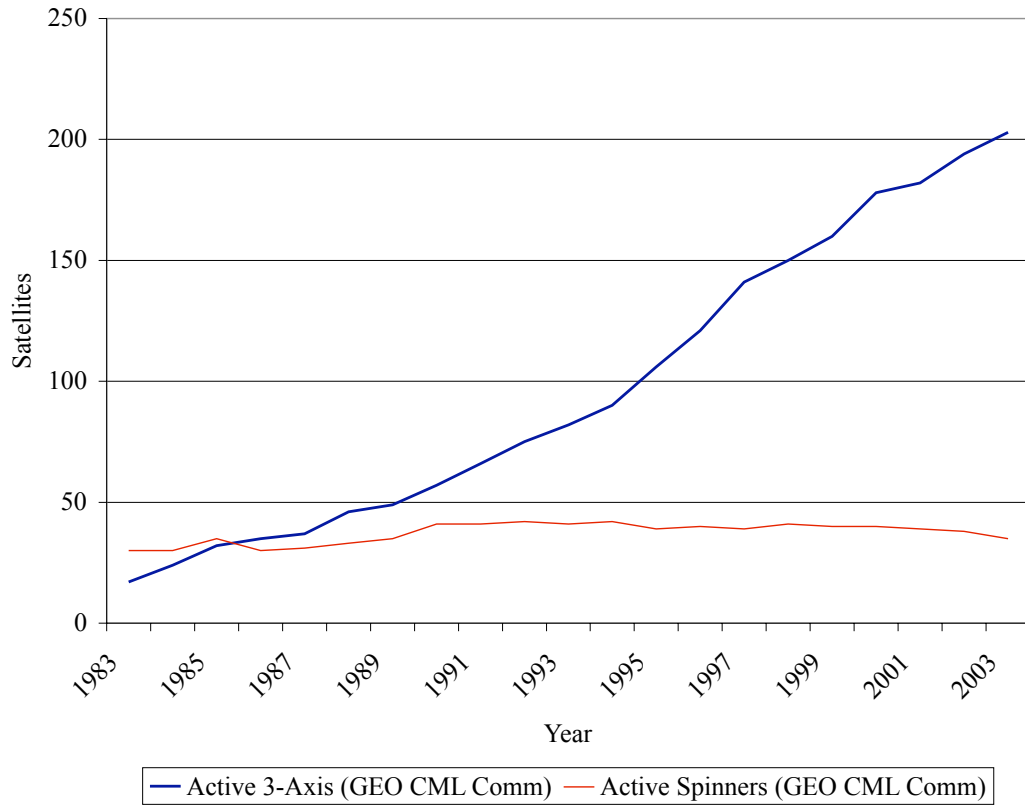

Figure 6.6: Stabilization Method Of Commercial Geosynchronous Communication Satellites, 1984 To 2003

6.6 Geosynchronous Communication Satellite Buses

Figure 6.7 shows the number of each spacecraft bus type launched over the 20 year period from 1984 to 2003. All of the buses which included at least four launches are included here. A time history by the major types is shown in Figure 6.8. Servicing fleets of similar spacecraft is likely more efficient than having to deal with a unique design on each servicing mission.

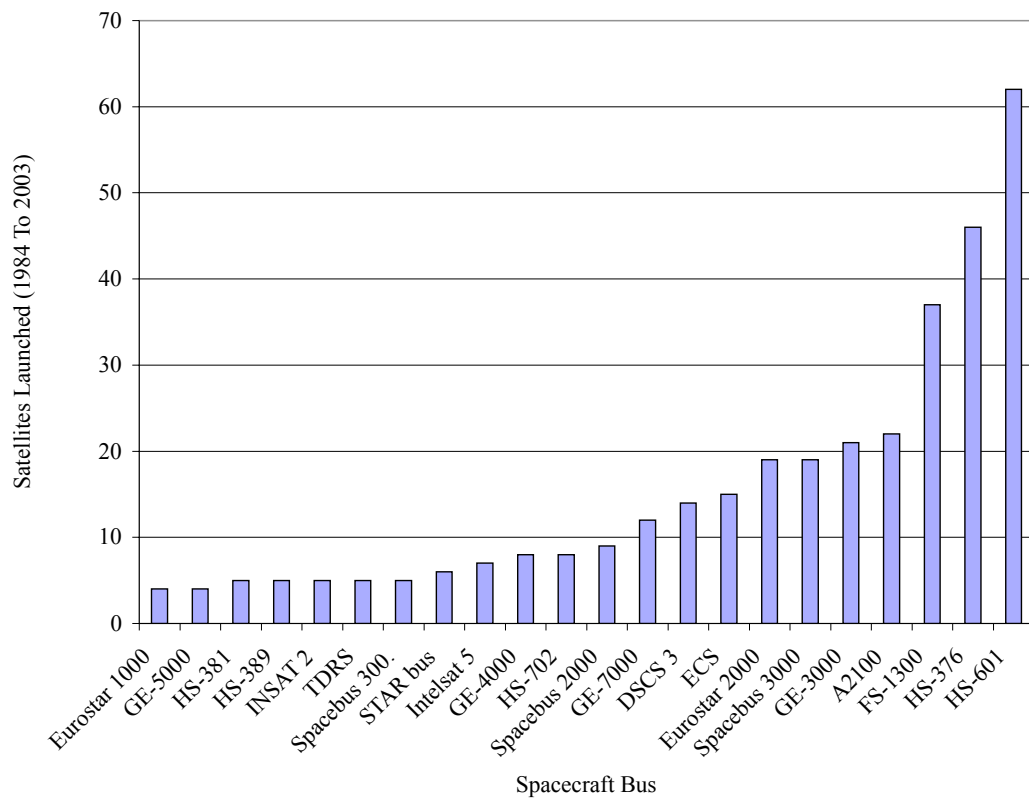

Figure 6.7: Geosynchronous Communication Satellite Buses, Launched From 1984 To 2003

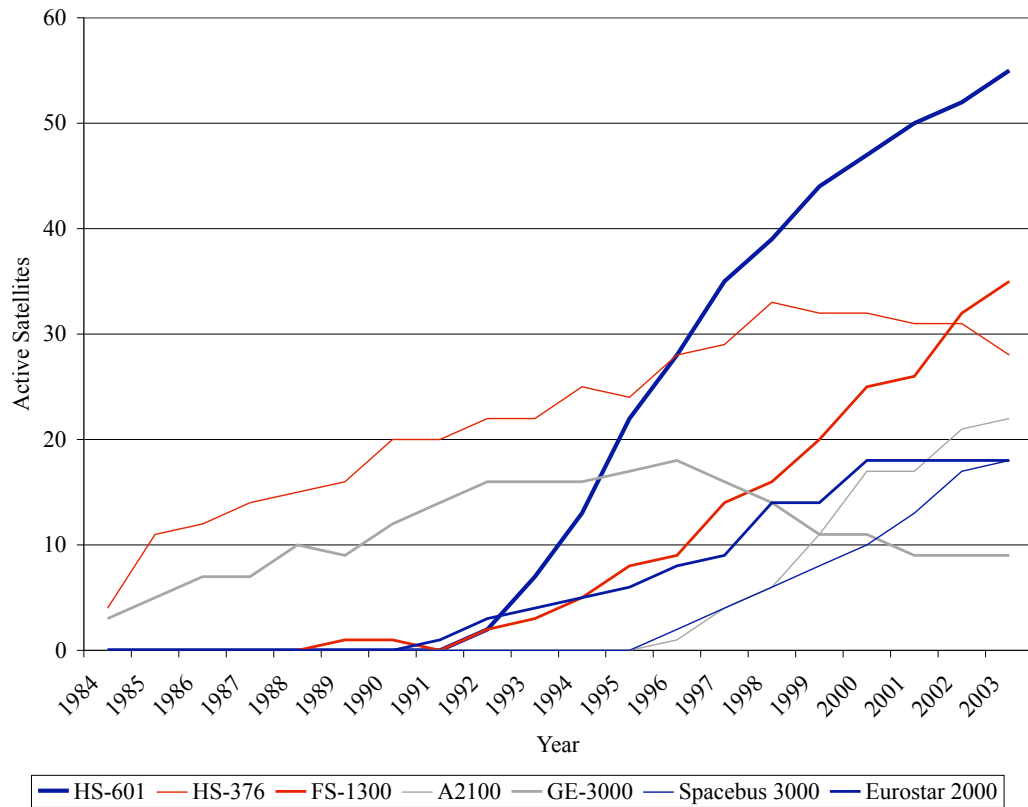

Figure 6.8: Active Geosynchronous Communication Satellites By Spacecraft Bus, 1984 To 2003

6.7 Commercial Geosynchronous Communications Satellite Design Life

Finally, Figure 6.9 the design life of commercial geosynchronous communications satellites is continuing to increase at a rate of about 0.28 years of design life per year. This trend towards long lived satellites invites the argument to provide refueling versus replacement of high-value orbital assets. These and other lifetime extension opportunities are included in Chapter 7.

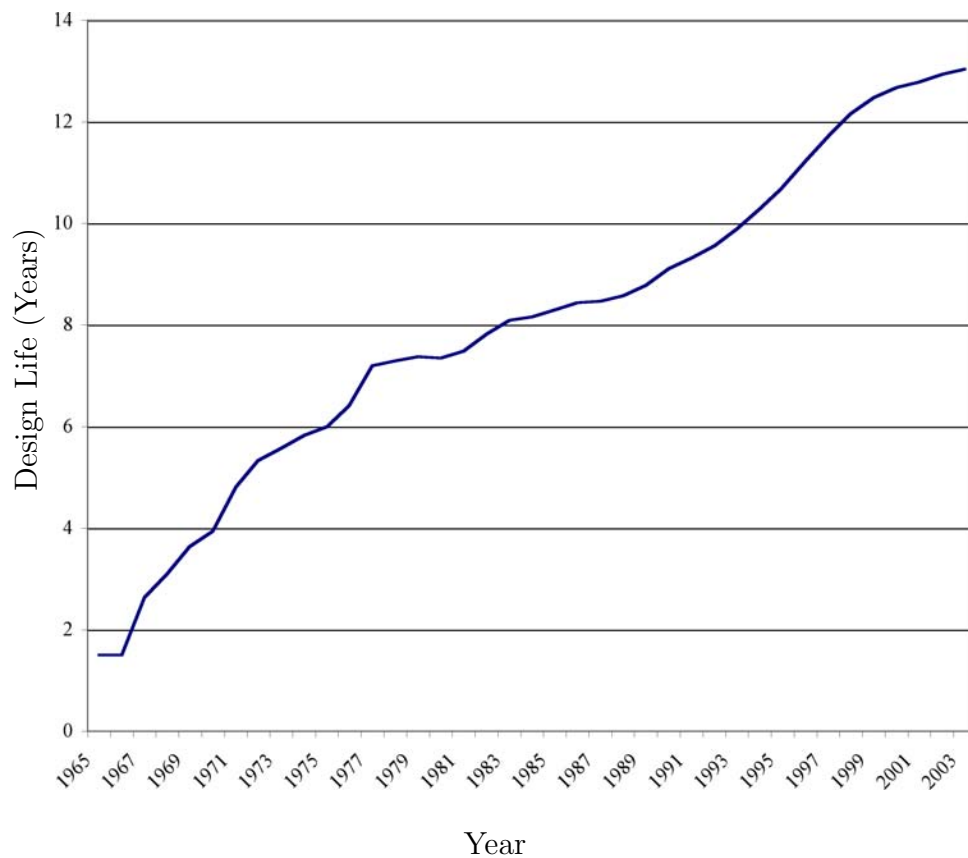

Figure 6.9: Average Design Life Of Active Geostationary Commercial Satellites

6.8 Bandwidth-Design Life Trends

Another measure of satellite capability is the bandwidth-design life (BW-DL) of the satellite. This is the communications capability of the satellite (in MHz) multiplied by the design life (in years) of the satellite. This represents the utility of the spacecraft over time. Figure 6.10 shows the total BW-DL launched per year over the last 20 years and the number of satellites launched. The satellites included are geosynchronous communications satellites with reported information on transponder bandwidth and design life. Both show the upward trend through the late 90's and the dramatic drop off for 2001 and 2002.

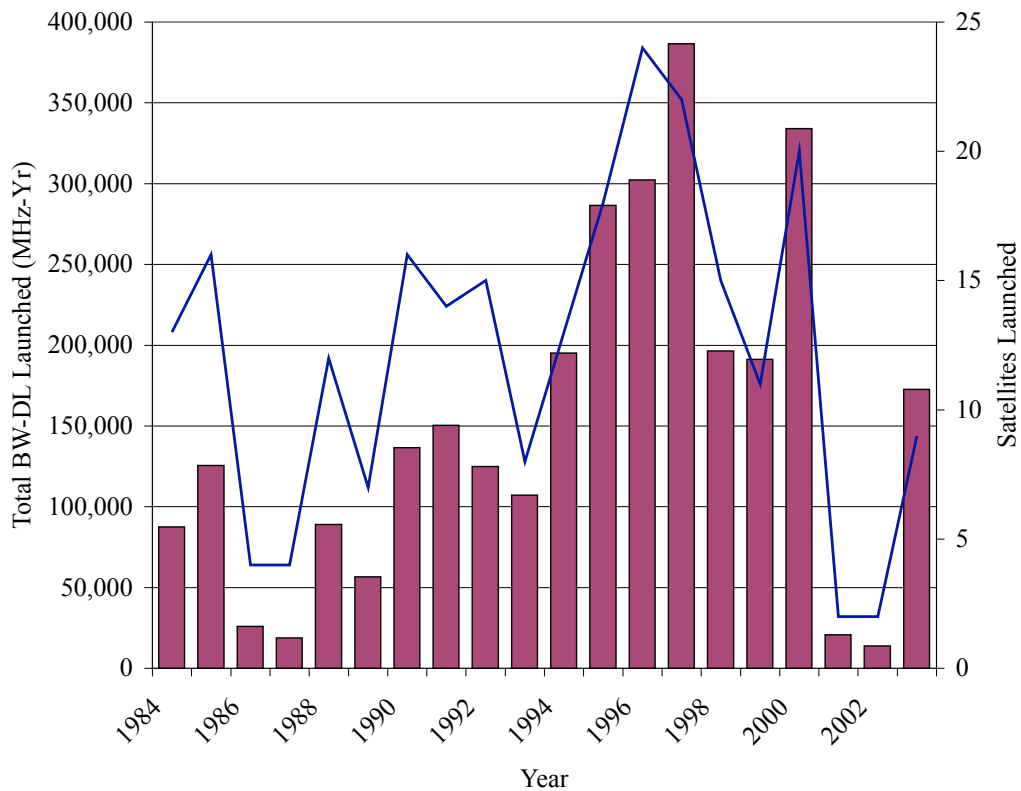

Figure 6.10: Total Bandwidth-Design Life Launched, 1984 to 2003

Examining bandwidth-design life on a per satellite basis is shown in Figure

6.11. Average, maximum, and minimum BW-DL are shown for geosynchronous communications satellites launched over the last 20 years. The spread between the max, min, and average show the variation in capabilities launched. In 2002 only 2 spacecraft (TDRS 9 & TDRS 10) with identical capabilities were launched, hence the intersection of all three data sets that year. Note that the average trend is upward over time. A five year moving average is shown in Figure 6.12 with a peak in 2000. The smaller number of launches of less capable satellites is contributing to the decline.

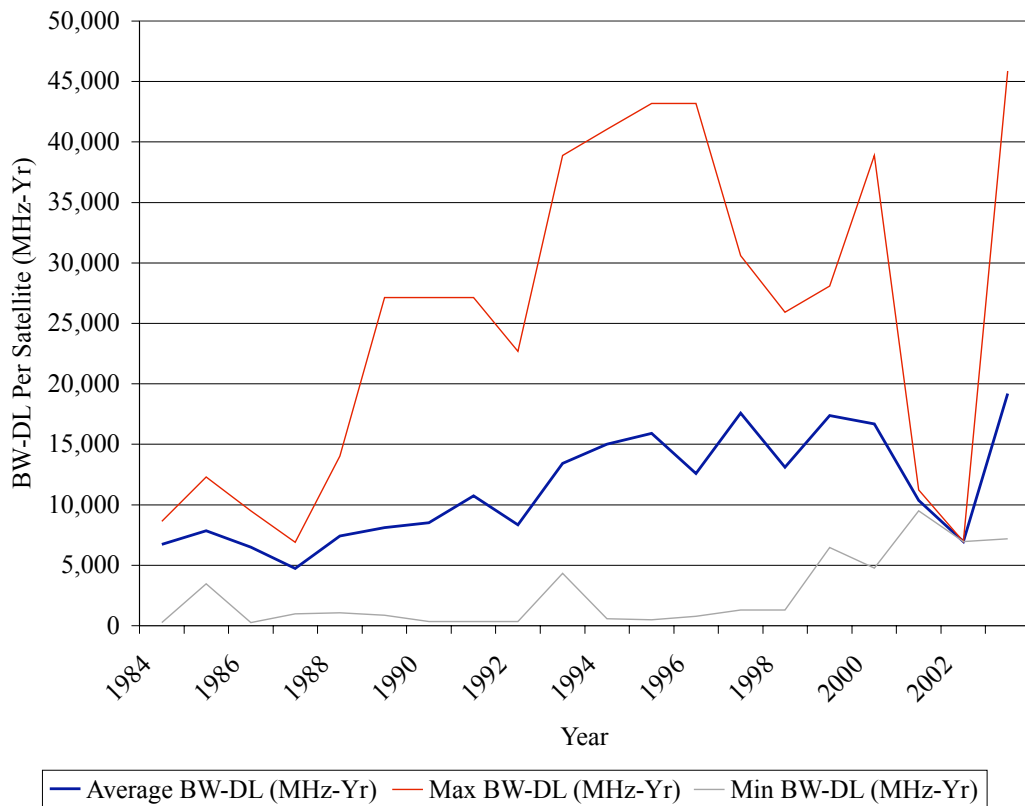

Figure 6.11: Bandwidth-Design Life Per Satellite, 1984 To 2003

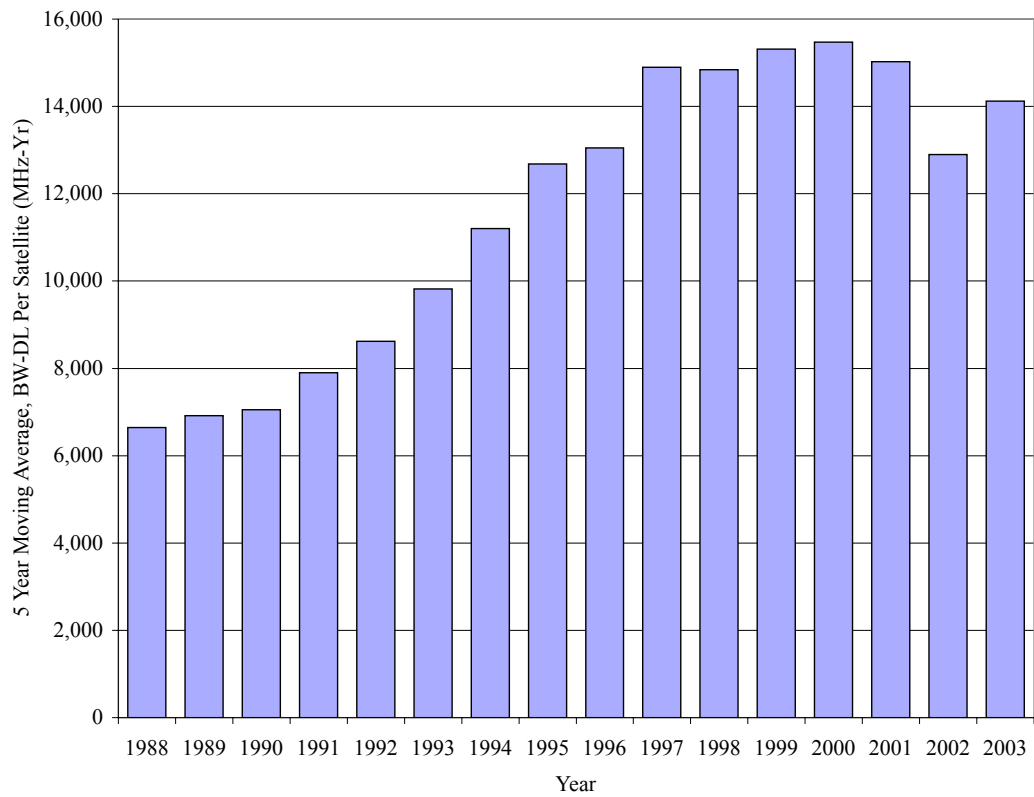

Figure 6.12: Five Year Moving Average, Bandwidth-Design Life Per Satellite

6.9 Failure Rate

For complex mechanical and/or electronic systems, the failure rate over time typically looks like Figure 6.13 ([43] and others). This “bathtub” curve is comprised of three regions corresponding to different phases of a system’s life. The high but decreasing failure rate of the initial section represents “infant mortality” or “burn-in” failures at the start of a system’s lifetime. The middle section with the nearly constant failure rate prevails for the midlife of a system, and the increasing rate at the end indicates the wear-out of systems at the end of their lives. Systems with constant failure rates are said to have a Poisson failure distribution.

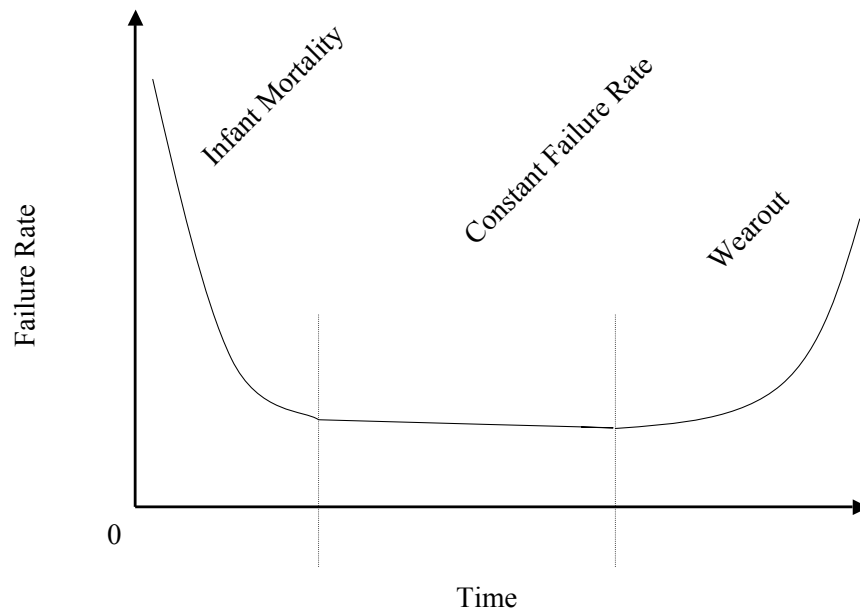

Figure 6.13: Typical Failure-Rate Curve Relationship (adapted from [43])

Having developed the satellite information and on-orbit failure databases, can satellites be observed to fit this classic Poisson failure distribution? Figure 6.14 shows the failure rate over time for all spacecraft with reported lifetime and failure information. To allow comparison of spacecraft with different lengths of design life, spacecraft lives are normalized with respect to their reported design lives. Considering the section up to 1 design-life, the curve somewhat conforms to the expected “bathtub.” Typically, such curves are found from thousands of data points. While hundreds of satellites are included here, the choppiness of the graph is likely a product of this limited data set. Also note that this analysis includes total failures only.

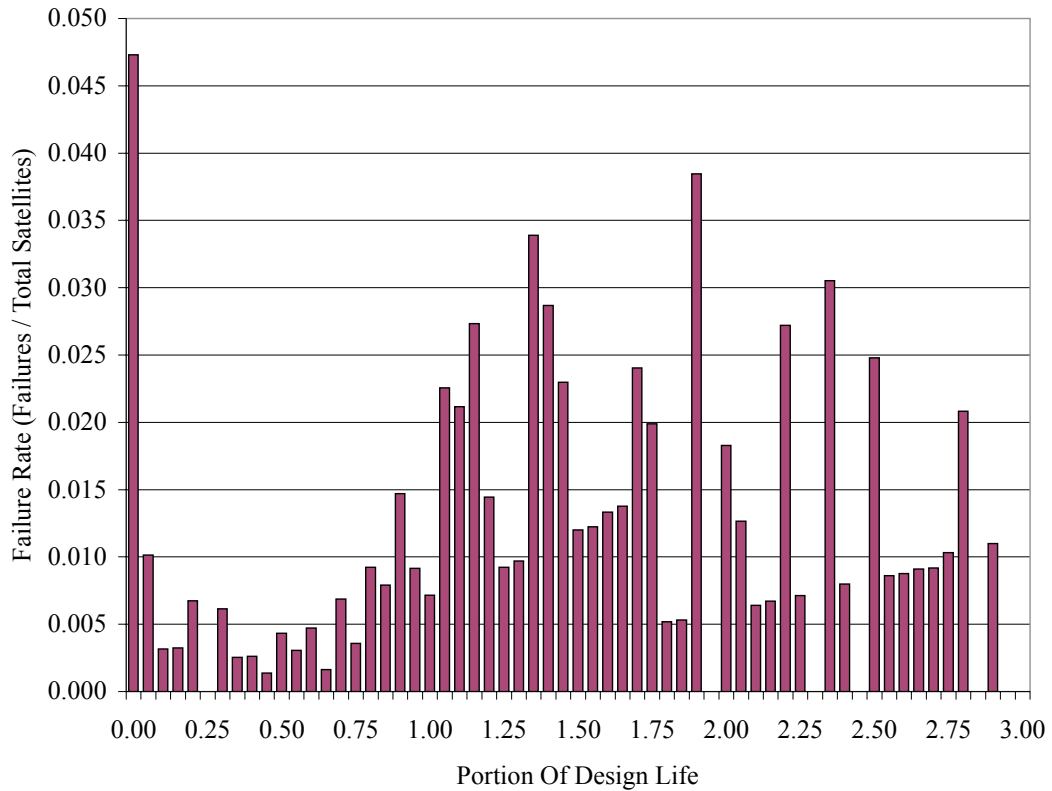

Figure 6.14: Failure Rate For All Satellites Launched From 1984 to 2003

A close look at the graph over the 1 design life section is shown in Figure 6.15. The zero time failures (“Infant Mortality”) are omitted. Again, this section is arguably consistent with a constant failure rate (Poisson), but cannot be definitively labeled as such. The average failure rate here is 0.54 % chance of failure per five percent of design life or 0.11 % chance of failure per percent of design life. Opportunities for servicing on-orbit failures based on information in the databases is evaluated in detail in Chapter 7.

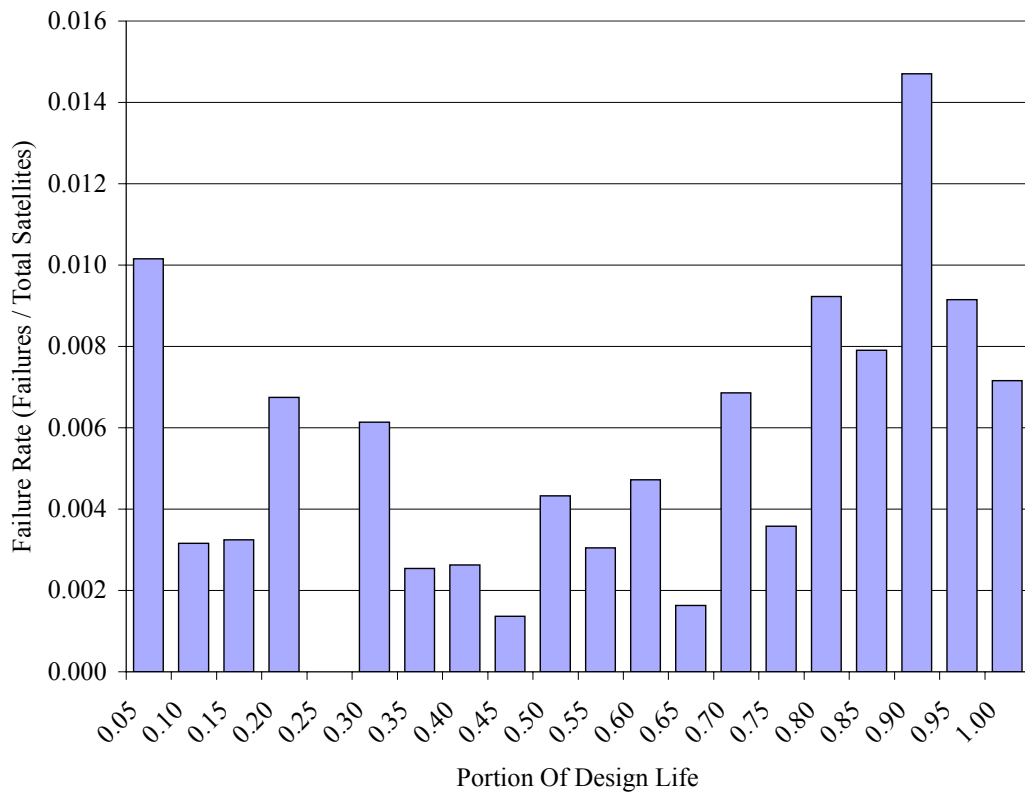

Figure 6.15: Failure Rate Over Design Life For All Satellites Launched From 1984 to 2003

Chapter 7

On-Orbit Servicing Opportunities

Based on the information developed in the satellite database and the on-orbit failures database, this chapter lays out the frequency and value of on-orbit servicing opportunities. The first two sections examine the launch rate and the economic impact of on-orbit failures. Subsequent sections examine servicing opportunities by type and attempt to quantify those markets. A summary of these opportunities is presented at the end of this chapter.

7.1 Launches And Payloads

This section examines the trends of launch attempts and payloads on-orbit. The history of all worldwide launch attempts and failures is shown in Figure 7.1. Vehicle explosions on the launch pad and other ground damage events are not included. Launches were counted once the launch vehicle left the pad. Launch failures include all vehicles that left the pad but that did not result in a payload making it successfully into orbit. Failure modes here include self-destruct, commanded destruction by Range Safety, in-flight breakup, and low launch vehicle performance resulting in suborbital flight. These cases are referred to as FTO (Failed To Orbit) in other parts of this study. Intentionally suborbital flights are not included.

An overall launch failure rate may be derived from this data. A summary of

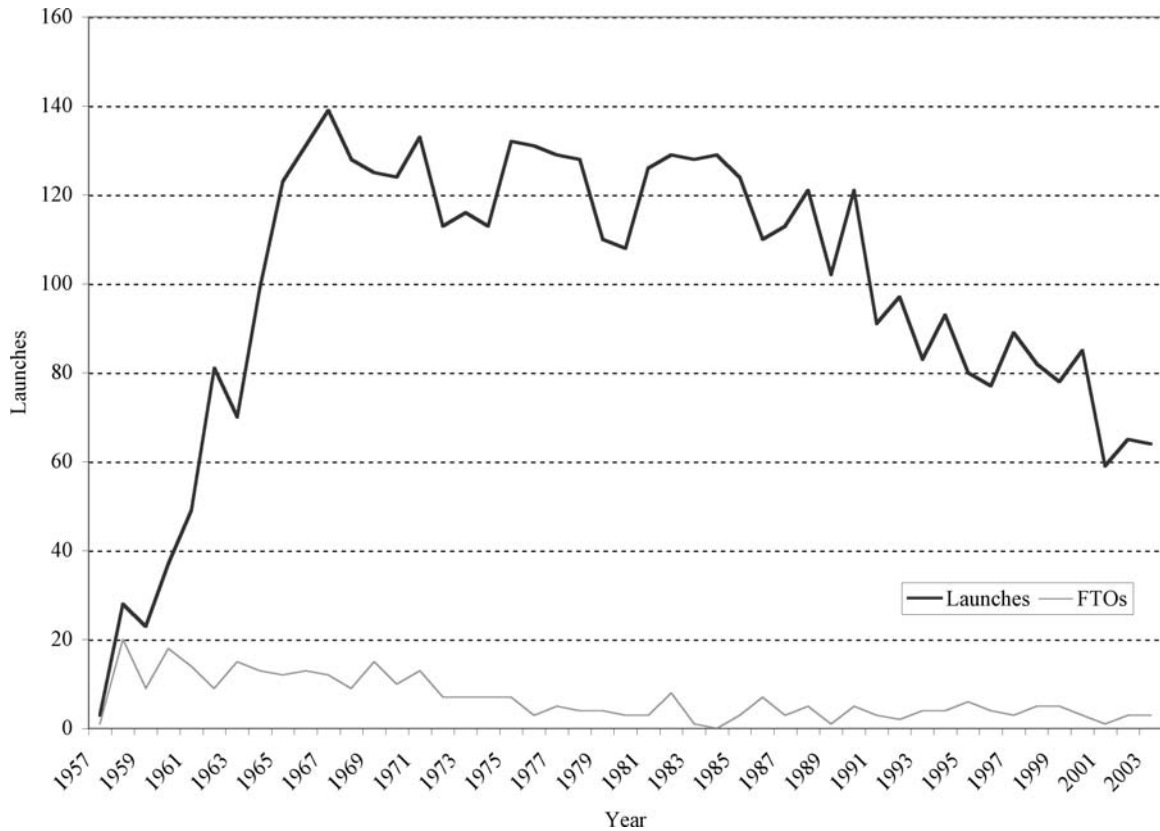

Figure 7.1: Launch Attempts And Launch Failures

the launch and failure rates are shown in Table 7.1. These 5, 10, and 20 year totals and annual averages include year spans up through 2003. The typical chance of launch failure appears to be about 4.5%, though this varies widely by launch vehicle.

Launch vehicles often carry multiple payloads, therefore, there are more payloads delivered to orbit per year than launches per year. Upper stages, fairings, and other launch vehicle components that reach orbit are not counted as payloads. While the raw number of payloads successfully orbited per year is useful, not all of these payloads are good candidates for on-orbit servicing. To focus the analysis, a number of satellites were filtered out a priori, including amateur radio satellites, ASAT related payloads, human spaceflight vehicles, satellites that exploded in orbit, spacecraft beyond earth orbit, simulated satellite test masses, and others. After subtracting these

	Launch Attempts	Launch Failures	Successful Launches	Chance of Failure
20 Year Totals	1,863	70	1,793	3.8%
10 Year Totals	772	37	735	4.8%
5 Year Totals	351	15	336	4.3%
20 Year Annual Average	93.2	3.5	89.7	
10 Year Annual Average	77.2	3.7	73.5	
5 Year Annual Average	70.2	3.0	67.2	

Table 7.1: Launches And Launch Failures

out, the payloads of interest remain. A summary of the payloads per year is shown in Table 7.2. These 5, 10, and 20 year totals and annual averages all include year spans up through 2003. These payloads per year totals will serve as a basis for various satellite failure rates developed later in this chapter. Additional payload trends can be found in Appendix A.

	Successful Launches	Payloads To Orbit	Filtered Payloads	Payloads Of Interest
20 Year Total	1,793	2,678	623	2,055
10 Year Total	735	1,210	346	864
5 Year Total	336	531	167	364
20 Year Annual Average	89.7	133.9	31.2	102.8
10 Year Annual Average	73.5	121.0	34.6	86.4
5 Year Annual Average	67.2	106.2	33.4	72.8

Table 7.2: Payloads Of Interest

7.2 Economic Impact Of On-Orbit Satellite Failures

The following figures illustrate the economic impact of on-orbit satellite failures. Spacecraft that were destroyed during launch or did not achieve initial orbit are not included in these analyses. A list of the specific satellites and failure information is shown in Appendix C.

Figure 7.2 shows the annual number of on-orbit failures and insurance claims over the 10 years from 1994 through 2003. These claims are shown in then-year dollars.

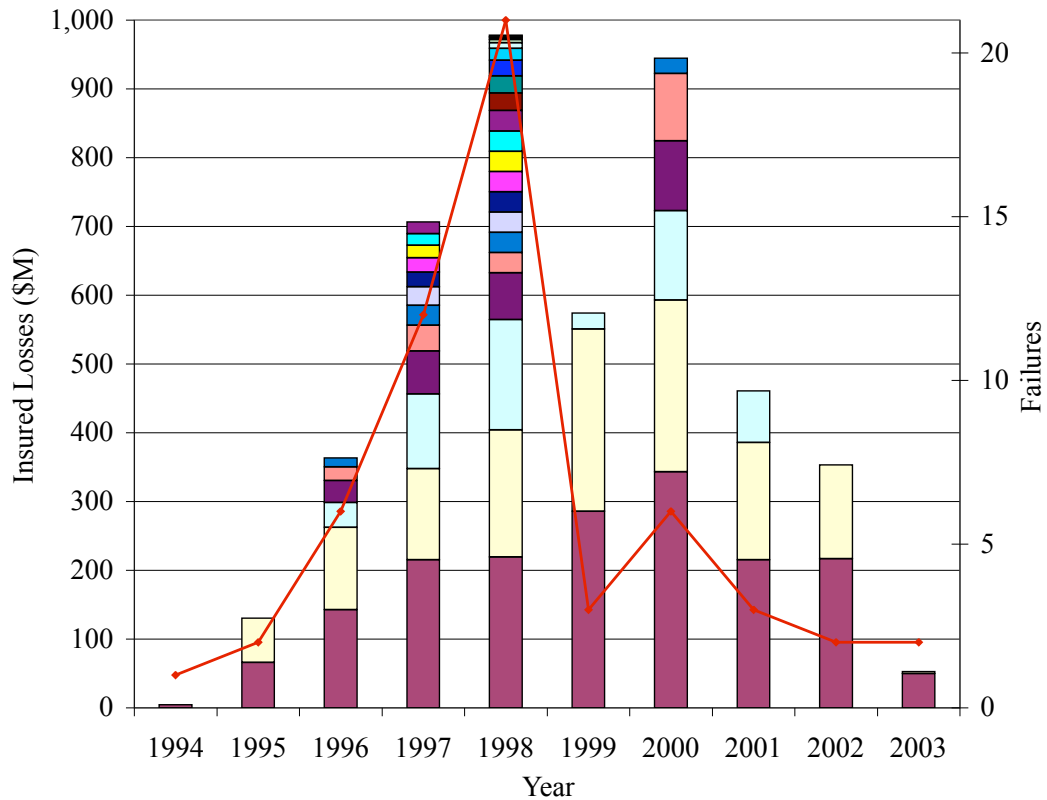

Figure 7.2: Insurance Claims For On-Orbit Satellite Failures

Figure 7.3 shows the estimated financial loss for uninsured on-orbit spacecraft losses over the 10 years from 1994 through 2003. Only failures that ended spacecraft operations were included. Additional significant partial failure events occurred. This figure also includes the estimated value of insured spacecraft where the insurance amounts were not published. For these uninsured failures, the estimated value of the spacecraft and launch costs are converted to 2003 dollars. This value is then prorated by the ratio of the satellite's actual life to its design life. The resulting value is converted back into then-year dollars and plotted during the year of failure. The inflation factors for these calculations are from BLS [9] and are shown in Appendix G.

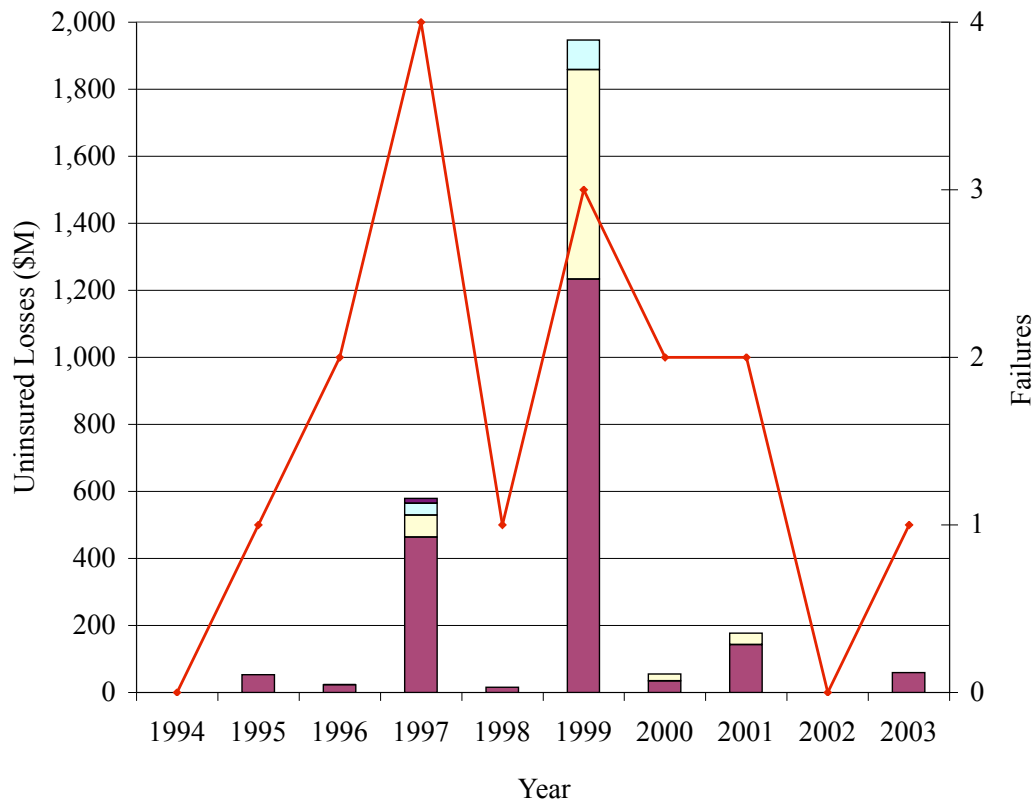

Figure 7.3: Estimated Value Of Uninsured On-Orbit Satellite Failures

A combination of the two previous figures is shown in 7.4. Over the last 10 years, while there was great variability, the annual average is 7.4 events valued at a total of \$748M or about \$100M per event. These figures demonstrate that on-orbit failures occur on a regular basis. While these rates of failures and significant economic impacts are notable, additional detailed analysis is required to identify specific servicing markets. Not all of these failures are serviceable. The following sections will delve into the failures database to identify serviceable failures.

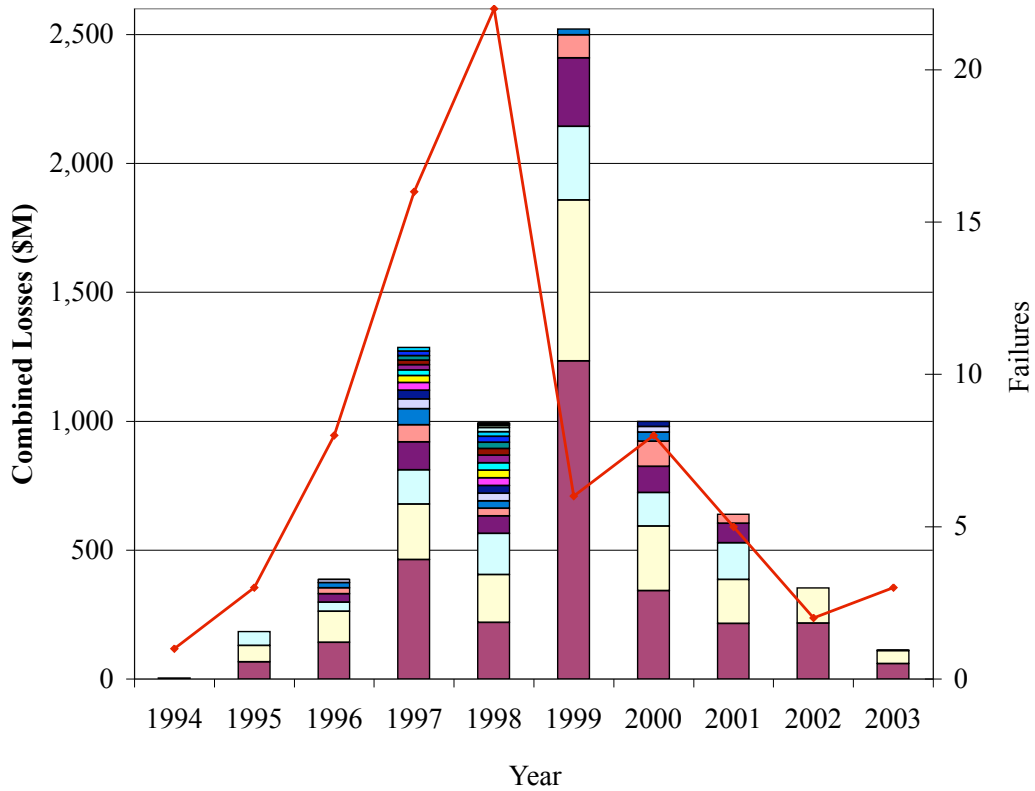

Figure 7.4: Value Of Insured And Uninsured On-Orbit Satellite Failures

7.3 Spacecraft Failure Servicing Opportunities

7.3.1 Wrong Orbit

This section examines the occurrence of satellites being delivered to the wrong orbit. For this failure case, the typical scenario is that a launch vehicle or upper stage malfunctioned and left the spacecraft in a lower than planned orbit. An example of this would be the Orion 3 commercial geostationary telecommunications satellite which was left in a low, unusable orbit. The spacecraft was perfectly healthy, but it was not in a location where it could perform its mission. It did not possess enough onboard fuel to achieve proper orbit and was subsequently abandoned. A servicer that could rendezvous and dock with this target and then relocate it to its proper position could potentially recoup an appreciable fraction of the value of the spacecraft. Launch anomalies related to spacecraft intended for geosynchronous operations will be examined initially. Where applicable, this analysis will be extended to spacecraft in other orbits.

7.3.1.1 GEO Launch Anomalies

The annual payloads launched to geosynchronous orbit (GEO) over the 20 years from 1984 through 2003 can be seen in Figure 7.5. Three categories of launch outcome are shown. Satellites that failed to orbit are indicated at the bottom of each column. The second category is for “Wrong Orbit” spacecraft. These are spacecraft that successfully made it into orbit, but were not delivered to the correct orbital location. The remaining spacecraft in the figure were successfully launched and maneuvered to their correct orbital locations. On average there is about one “Wrong Orbit” failure per year for satellites intended for GEO.

Further detail on the “Wrong Orbit” GEO spacecraft is seen in Figure 7.6. The outcomes for these spacecraft include rescue by STS, self rescue, partial use,

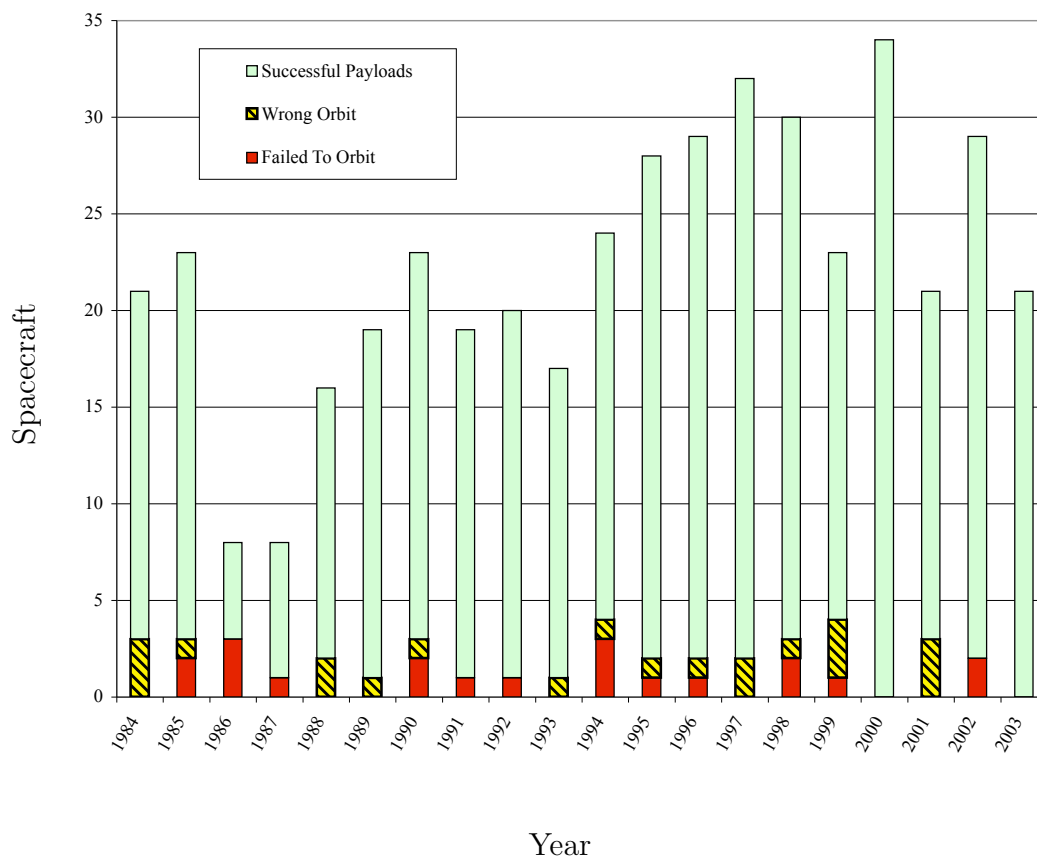

Figure 7.5: Results Of Launch Attempts To Geosynchronous Orbit

and total loss. STS rescued satellites were repaired on orbit or retrieved for ground refurbishment by the Shuttle. Self rescue satellites utilized onboard fuel to achieve correct GEO orbit. Substantial lifetime and revenue reduction was the typical penalty for this method. Inclined operation was also common for these spacecraft, resulting in reduced revenues. Some spacecraft with insufficient fuel to reach GEO accomplished partial mission objectives in elliptical sub-geosynchronous orbits. The final category is for spacecraft with no possibility of useful life that were abandoned in orbit or commanded to re-enter.

Figure 7.5 and Figure 7.6 illustrate the regular occurrence of “Wrong Orbit” anomalies for GEO spacecraft. The economic impacts are also significant as shown

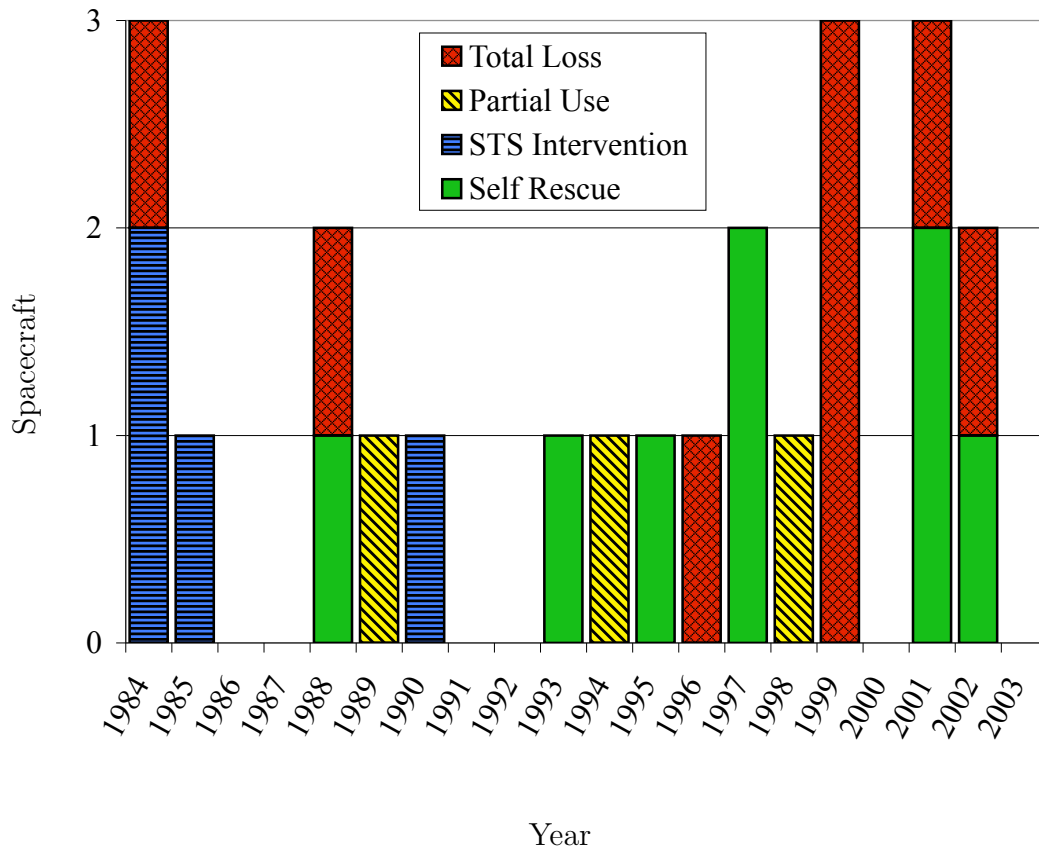

Figure 7.6: Results Of Launch Anomalies For Geosynchronous Payloads

in Table 7.3. Values are in then-year dollars. Most of the values shown represent reported insured losses. For other affected spacecraft “Spacecraft Value” is composed of reported satellite manufacturing costs, launch costs, insurance costs, and other program costs. Insurance claims are typically in the range of 50 to 100 % of “Spacecraft Value.” For the spacecraft that used onboard fuel to reach GEO, some part of the spacecraft value was salvaged.

Another look at the GEO FTO (Failed To Orbit) and “Wrong Orbit” (WO) events is shown in Figure 7.7. This shows that the five year moving averages of FTOs are trending down over time and “Wrong Orbit” failures are trending up over time. Viewing these in Figure 7.8 as percentages of satellites launched to GEO reveals

#	Year	Satellite	Anomaly Outcome	Value (\$M)	Basis
1	1984	Westar 6	Retrieved by STS	105	Insurance Claim
2	1984	Palapa B2	Retrieved by STS	56	Insurance Claim
3	1984	Intelsat 509	Commanded Deorbit	102	Insurance Claim
4	1985	Leasat 3	Repaired by STS	20	Insurance Claim
5	1988	USA 31	Total Loss		Unpublished
6	1988	GStar 3	Used onboard fuel	65	Insurance Claim
7	1989	Hipparcos	Partial Mission	500	Spacecraft Value
8	1990	Intelsat 603	Repaired by STS	260	Spacecraft Value
9	1993	UFO 1	Used onboard fuel	188	Insurance Claim
10	1994	ETS 6	Partial Mission	668	Spacecraft Value
11	1995	Koreasat 1	Used onboard fuel	64	Insurance Claim
12	1996	Chinasat 7	Total Loss	120	Insurance Claim
13	1997	Agila 2	Used onboard fuel	290	Spacecraft Value
14	1997	HGS-1	Used lunar flyby	215	Insurance Claim
15	1998	COMETS	Partial Mission	8	Insurance Claim
16	1999	DSP 19	Total Loss	625	Spacecraft Value
17	1999	Milstar 2-1	Total Loss	1,233	Spacecraft Value
18	1999	Orion 3	Total Loss	265	Insurance Claim
19	2001	GSAT 1	Used onboard fuel		Unpublished
20	2001	Artemis	Used onboard fuel	75	Insurance Claim
21	2001	BSAT 2B	Total Loss	143	Spacecraft Value
22	2002	DRTS	Used onboard fuel	311	Spacecraft Value
23	2002	Astra 1K	Commanded Deorbit	217	Insurance Claim

Table 7.3: Economic Impacts Of GEO Wrong Orbit Failures

five year moving averages which also show FTOs trending down and “Wrong Orbit” failures trending up.

The altitude history shown in Figure 7.9 of the Koreasat 1 satellite is an illustration of the gradual orbit raising of a satellite that was delivered into a low orbit. The satellite’s onboard engines are smaller than the upper stage engine and require a longer period to achieve the same change in orbital altitude. For comparison, the altitude history of a nominal launch for a similar satellite, Koreasat 2, is also shown. Both satellites are GE-3000 type spacecraft and were launched on Delta II rockets. To get from its initial low orbit to GEO, Koreasat 1 had to burn 7.5 of its 12 year

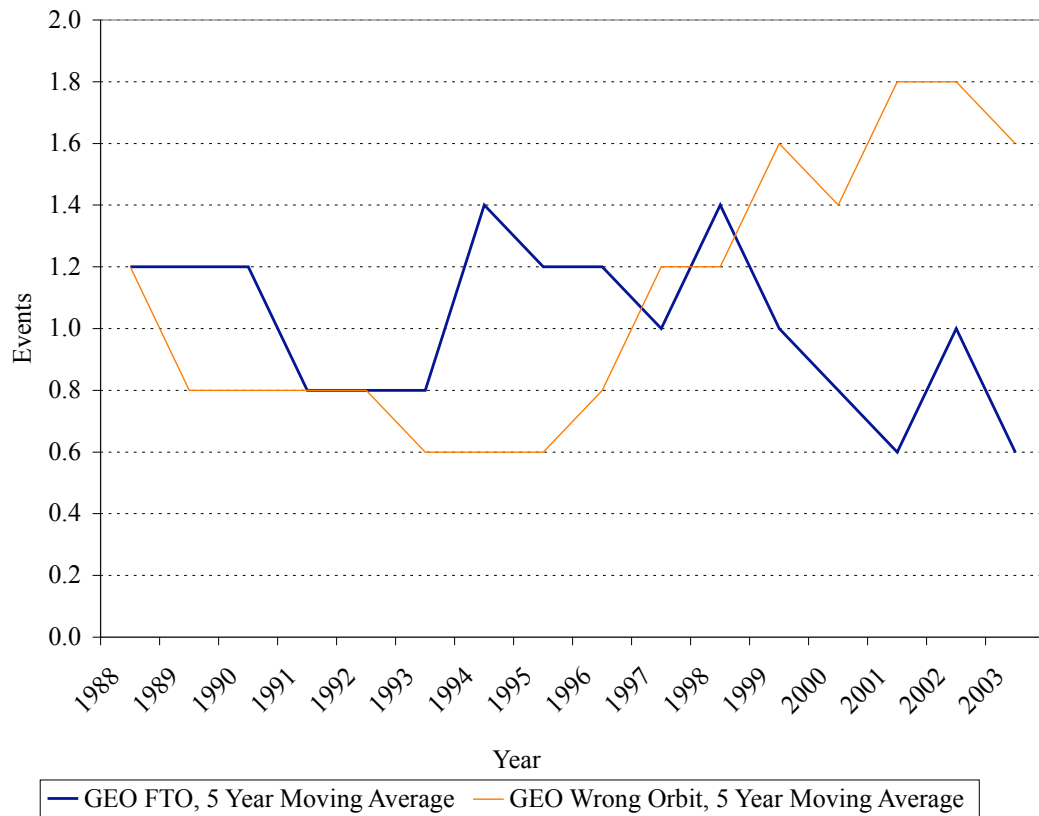

Figure 7.7: GEO FTO And WO Five Year Moving Averages

lifetime fuel supply. It has also given up North-South station-keeping to extend its life, hence it now operates in inclined mode. Altitude and inclination histories for additional satellites that utilized onboard fuel for self rescues are shown in Appendix D.

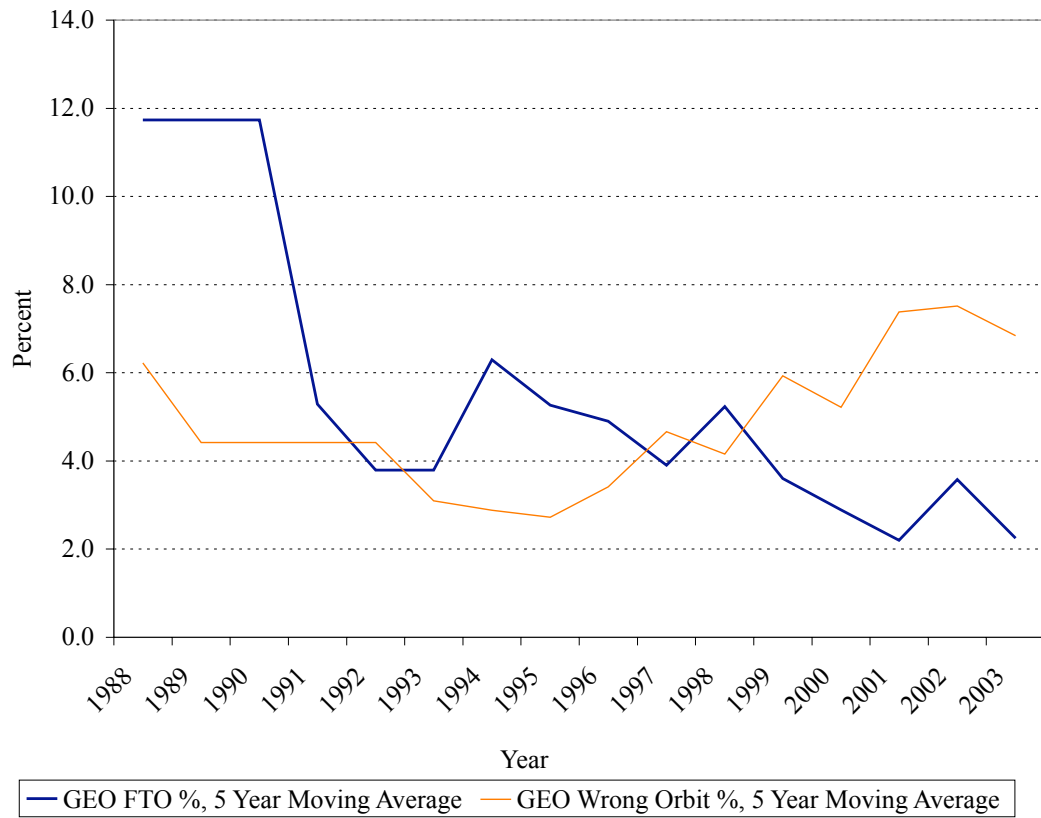

Figure 7.8: GEO FTO And WO Five Year Moving Averages

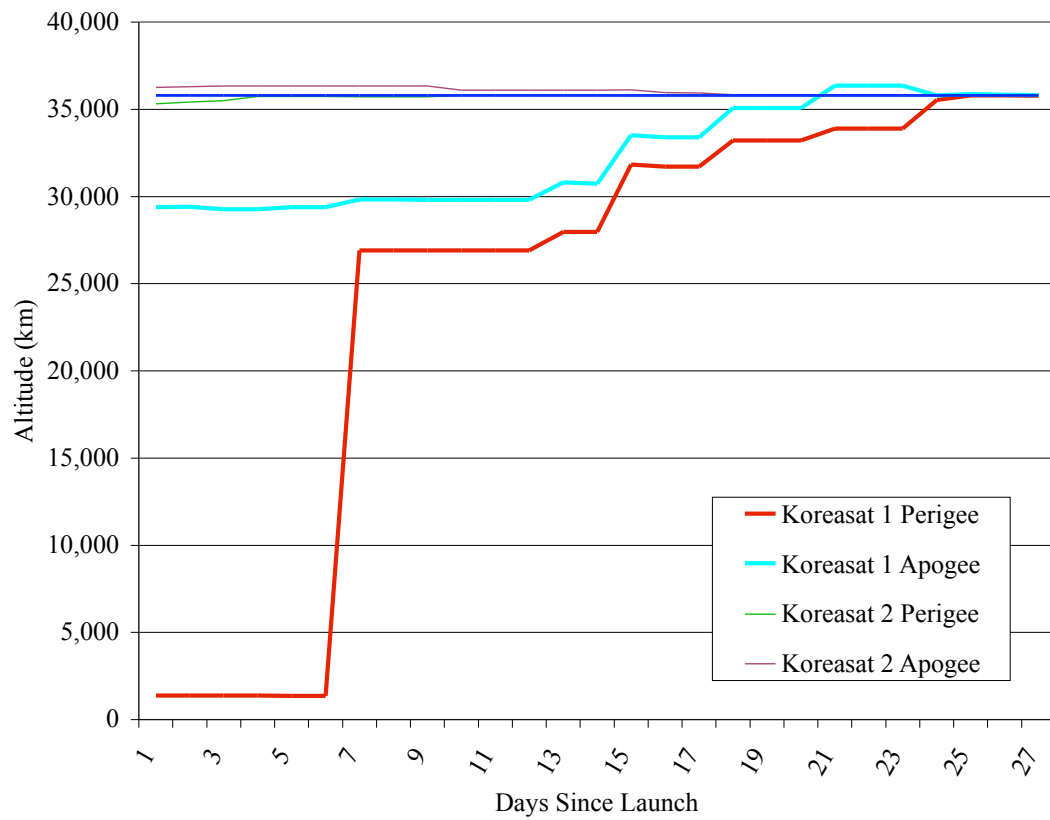

Figure 7.9: Koreasat 1 Altitude History

7.3.1.2 Other Launch Anomalies

While the previous section addressed launch anomalies for payloads intended for geosynchronous orbit, anomalies have occurred for payloads intended for other orbits. There are no reported MEO failures of this type, and there are only two reports of LEO spacecraft that were injected into low orbits. In 1990 the US Military DMSP F10 satellite was placed in a lower than planned orbit due to the failure of its AKM nozzle. Despite its lower than planned altitude, it was able to perform most of its meteorological mission. In 1997 the Indian Space Research Organization's IRS 1D satellite was launched into a low orbit due to a launch vehicle anomaly. Using on board fuel, it was able to achieve a useful elliptical sun synchronous orbit, versus a planned circular sun synchronous orbit. Because these opportunities are few and far between, LEO only "Wrong Orbit" servicing does not appear to be a viable market.

7.3.2 Deployment Problems

Once a satellite reaches its operating location in orbit, it will typically deploy antennas and solar arrays that were stowed during launch. Table 7.4 lists seven such reported failures from 1984 through 2003. Partial failure of the solar arrays to deploy limits the power available to spacecraft. Total failure to deploy arrays can limit the life of the satellite to its initial battery charge. Antenna deployment failures limit a communications satellite's ability to fulfill its mission. Converting these loss values to 2003 dollars and averaging, yields a loss of \$91.1M per event or \$31.9M per year over the last 20 years.

7.3.3 Component Failures

During the life of a spacecraft, any number of systems or components can degrade or fail. Redundancy in design is the only current method to address these failures.

Year	Satellite Name	Deployment Failure	Level	Orbital Location	Event Value (\$M)	Basis
1987	TVSat 1	Solar Array	Total	GEO	51	Insurance Claim
1989	INSAT 1C	Solar Array	Major	GEO	68	Insurance Claim
1990	BS-3A	Solar Array	Partial	GEO	8.6	Estimated Revenue Loss
1996	Asiasat 2	Antenna	Partial	GEO	36	Insurance Claim
1997	STEP M4	Solar Array	Total	LEO 300 km	66.0	Spacecraft Total Loss
1998	Echostar 4	Solar Array	Major	GEO	219.3	Insurance Claim
1998	PAS 8	Antenna	Major	GEO	68	Insurance Claim

Table 7.4: Spacecraft Suffering Deployment Anomalies

The robotic dexterity required to repair or replace these components varies by failure type. For spacecraft designed for servicing (HST, ISS), the critical components that may need replacement are designed as replaceable modules called Orbital Replaceable Units (ORUs). While none of the current GEO spacecraft are explicitly designed in such a modular fashion, certain current components are somewhat ORU-like. Replacing a failed battery, reaction wheel, or similar ORU-like component requires a basic level of dexterity and complexity. Trouble-shooting a problematic power system or propulsion system plumbing requires a higher order of magnitude in dexterous complexity. Looking at the failures of interest and focusing on those that were ORU type of failure on spacecraft that remained under control yields a history of potentially serviceable ORU-like failures.

For GEO satellites, Figure 7.10 shows that there were an average of 4.4 annual ORU-like failures over the ten year span from 1994 through 2003. Because these were GEO satellites, the value of the affected spacecraft was in the \$100M range. Some

of these events led to significant insurance claims, and others were accommodated by the spacecraft's design redundancy. These rates and values show that a potential market might exist if there were a servicer to address these failures, however, there does not appear to be enough frequency to form a market on its own. The additional major caveat is that none of these spacecraft is designed for on-orbit servicing so the ORU-ness of their design is low.

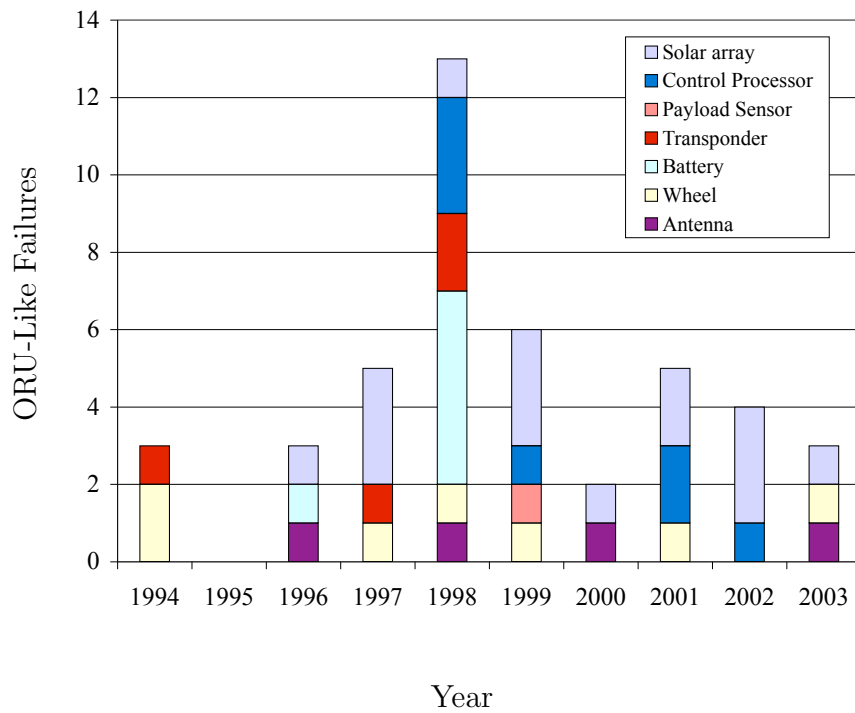

Figure 7.10: ORU-Like Failures In GEO

A similar analysis was performed for LEO spacecraft as seen in Figure 7.11. A lower rate of 1 ORU-like failure per year was found. The LEO spacecraft also had a generally lower economic value.

In addition to the ORU-like failures shown, an additional three GEO satellites suffered ORU-like failures but became unstable shortly thereafter and are not included. Over the course of the same 1994 to 2003 period, there were five of these type of failures in LEO satellites. Once the ability to service stable targets is shown,

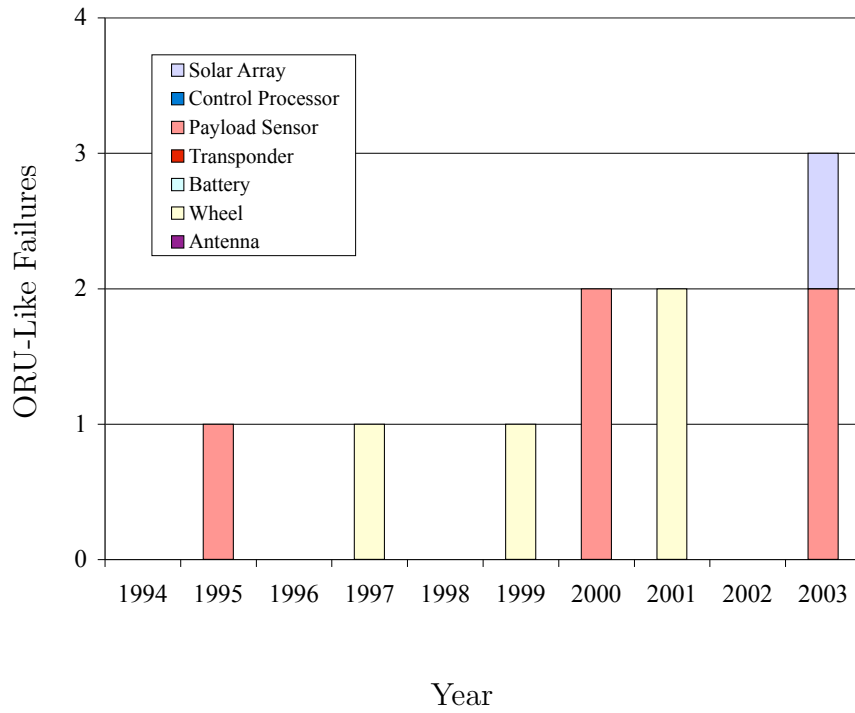

Figure 7.11: ORU-Like Failures In LEO

perhaps addressing these failures on un-commanded spacecraft can be attempted as well.

7.3.4 Fuel Depletion

A number of spacecraft have experienced early fuel depletion for a variety of reasons. One case occurs when a fault sends a spacecraft into a safe mode. While the spacecraft controller is operating at a diminished capacity, an unexpected spacecraft disturbance can lead to inefficient use of propellant to maintain stability. Another increase in fuel consumption can occur when thrusters on the spacecraft fail. Usually operations can continue, but fuel efficiency is affected and propellant consumption occurs at a higher than normal rate. There have also been failures of xenon ion propulsion systems, resulting in spacecraft switching to backup conventional propulsion systems with greatly reduced lifetime capacity. Instances of all of these types of failures are shown in Table 7.5 and are reported primarily for GEO spacecraft.

7.3.5 Other Failures

In addition to the failures described, other potentially serviceable failures have occurred. These include spacecraft with challenging servicing needs such as systemic problems with their power, communications, or propulsion systems. This category also includes “Unknown” failures where a failure has occurred but few or no details have been published. Figure 7.12 shows that these failures occur with some regularity and breaks the 38 events out between stable and unstable spacecraft. Addressing these failures would be even more challenging than the already described scenarios. The difficulty here is that these tend to be systemic rather than component level problems. Ambiguity in the reported failure symptoms also drives some events into this category. Additional information on these failures is included in Appendix C.

Service of such spacecraft would have the highest requirements for robotic dexterity, human supervision of operations, and contingency spares to address poorly understood satellite anomalies. The high dexterity is needed to have broad ability to

#	Year	Satellite Name	Failure Description	Failure Level	Orbit	Value (\$M)
1	1996	Hot Bird 2	Abnormal fuel consumption. Leaking thrusters.	Lifetime	GEO	280
2	1997	Intelsat 801	Inadvertent spin during testing. Substantial fuel expended. Spacecraft recovered.	Lifetime	GEO	162
3	1998	JCSat 1	Fuel system leak	Lifetime	GEO	
4	1998	TOMS EP	Fuel exhausted in safe mode anomaly	Total	LEO	56
5	2000	Galaxy 8i	Xenon ion propulsion systems failed. Lifetime reduced from 15 to 5 years	Lifetime	GEO	250
6	2000	INSAT 2B	Inadvertent oxidizer depletion	Total	GEO	106
7	2001	GSAT 1	Fuel depleted attempting to stabilize unbalanced satellite	Total	GEO	
8	2002	TDRS 9	One of four tanks cannot be pressurized normally. Using less efficient work around.	Partial	GEO	298
9	2002	Echostar 8	2 of 12 thrusters have failed. Uses higher than normal fuel being consumed.	Partial	GEO	235
10	2003	Galaxy 4R	Xenon ion propulsion system failed. Lifetime reduced from 15 to 3 years.	Lifetime	GEO	240
11	2003	PAS 6B	Xenon ion propulsion system failed. Lifetime reduced from 15 to 4.5 years.	Lifetime	GEO	240

Table 7.5: On-Orbit Fuel Depletion Anomalies (1994 to 2003)

address potential servicing tasks. Increased human supervision is needed to make real time assessment of the state of the target satellite (rather than preplanning against a well understood failure type) and to determine the repair actions required. Because the repair required is either extensive and or widespread, the repair kit would need more components than a well characterized mission. Increased dexterity and spares drive up the mass and cost of the servicing mission. The increased human supervision could drive the need for additional camera views, communications bandwidth, and ground station personnel. All of which also drive up cost.

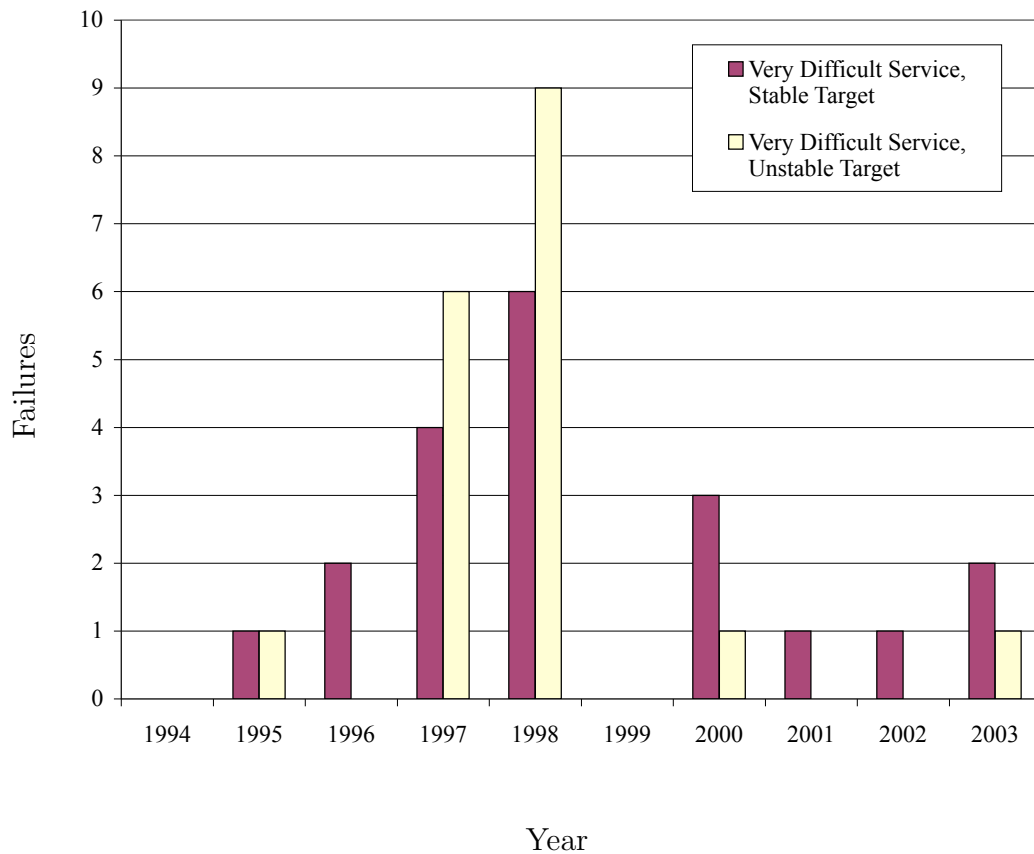

Figure 7.12: Additional Servicing Opportunities

7.3.6 Spacecraft Family Anomalies

Upon examining the component failures analysis in Section 7.3.3, certain repeated failures emerge. Some spacecraft have common design or component flaws. A number of these common anomalies are addressed in the following subsections.

7.3.6.1 BSS-601 Spacecraft Control Processors

A number of the Boeing Satellite Systems model 601 geosynchronous communications satellites launched before August 1997 have tin-plated relay switches. Under the influence of the space environment, these switches can develop tin whiskers that cause electrical shorts resulting in the failure of the Spacecraft Control Processor (SCP). The 601s have a primary and a backup SCP. Loss of both SCPs leads to loss of vehicle. Table 7.6 shows the 601s that are vulnerable to this problem. The estimated cost column is the sum of the manufacturing costs and the launch costs associated with the each satellite and is shown in then-year dollars. Long term net value of the potential revenue stream is even higher. The US military also has a set of ten UHF Follow-On GEO communication satellites that are based on the same bus. So far no such failures have been reported for this set.

The common failure mode for this whole family of high value satellites represents a prime opportunity for a dexterous servicer. Based on reported design life, Figure 7.13 shows how many of these spacecraft will continue in operation for the near future. As noted in Section 7.4.2 these spacecraft are often operated for 125% of their nominal design life or about 3.5 additional years, so Figure 7.13 is likely a conservative illustration.

7.3.6.2 BSS-702 Solar Arrays

The Boeing 702 model satellites included a new solar array configuration with solar concentrators. The optical qualities of these arrays have degraded more rapidly than

Satellite Name	Launch Date	SCP	Est. Cost (\$M)	Design Lifetime (yrs)	Years Before Failure
Optus B1	8/13/92	Possible Tin	212	13.7	
Galaxy 7	10/28/92	Both Failed	235	15	8.1
Astra 1C	5/12/93	Possible Tin	166	15	
Galaxy 4	6/25/93	Both Failed	250	15	4.9
Solidaridad 1	11/20/93	Both Failed	152	14	6.8
DirecTV 1	12/18/93	One Failed	247	15	
PAS 2	7/8/94	Tin-plated relay	162	15	
DirecTV 2	8/3/94	Possible Tin	275	15	
Optus B3	8/27/94	Possible Tin	206	13.7	
Solidaridad 2	10/8/94	Possible Tin	161	14	
Astra 1D	11/1/94	Possible Tin	158	15	
AMSC 1	4/7/95	Possible Tin	262	12	
DirecTV 3	6/10/95	One Failed	275	15	
PAS 4	8/3/95	One Failed	198	16	
JCSat 3	8/29/95	Possible Tin	206	12	
Astra 1E	10/19/95	Possible Tin	198	15	
Galaxy 3R	12/15/95	One Failed	230	10	
PAS 3R	1/12/96	Tin-plated relay	157	15	
Anatolia 1	2/1/96	Possible Tin	154	14	
Astra 1F	4/8/96	Possible Tin	160	15	
MSAT M1	4/20/96	Possible Tin	222	12	
Palapa C2	5/16/96	Possible Tin	128	14	
JCSat 4	2/17/97	Possible Tin	200	12	
Superbird C	7/28/97	Possible Tin	200	13	

Table 7.6: BSS-601 Spacecraft Susceptible To SCP Failure

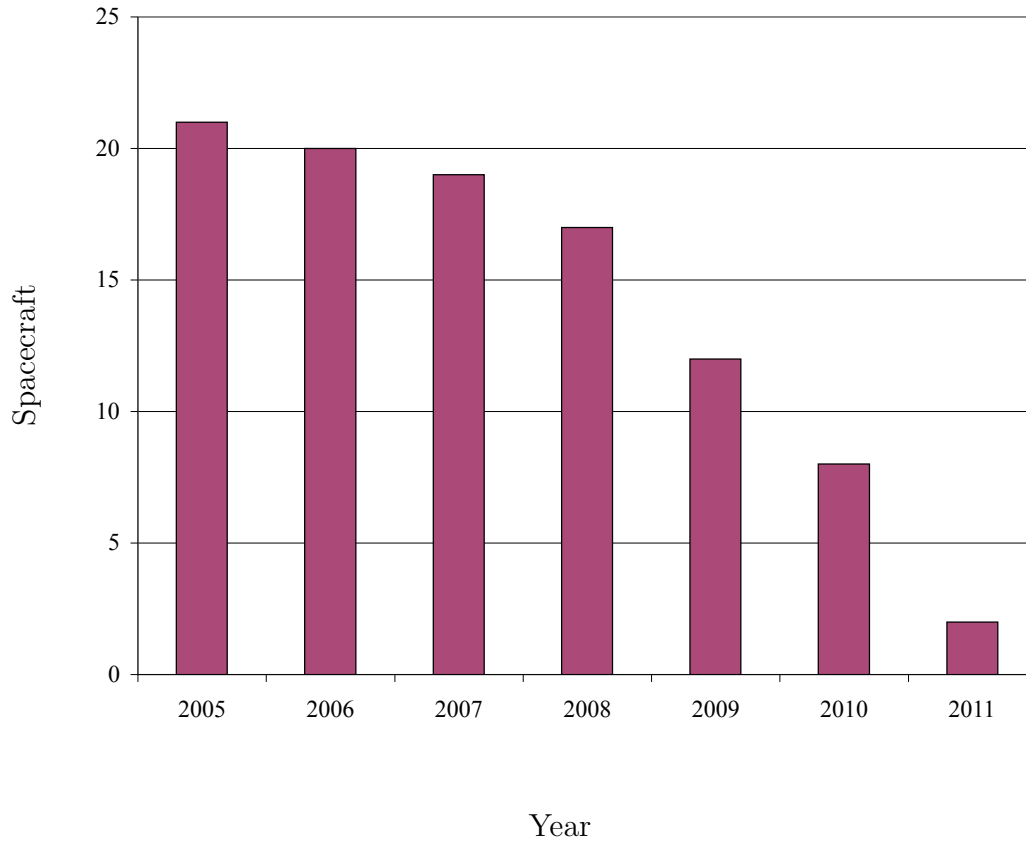

Figure 7.13: SCP Vulnerable BSS-601s Remaining In Service

predicted and the power production has declined as a result. It is anticipated that the spacecraft will reach end of life power levels sooner than originally planned. Some pessimistic estimates indicated EOL power in 5 years versus the intended 15. Table 7.7 shows the model 702 satellites with this problem. Subsequent 702s use different arrays.

On-orbit replacement of these solar arrays would be a significant challenge, however, the spacecraft will remain stable with high value (but underpowered) commercial communications payloads into the 2010s.

#	Satellite Name	Launch Date	Design Lifetime (yrs)	Insurance
1	Galaxy 11	12/22/99	15	\$286M Paid
2	Thuraya 1	10/21/00	12	\$250M Pending
3	PAS 1R	11/16/00	15	\$343M Paid
4	Anik F1	11/21/00	15	\$136M Paid so far
5	XM-2	3/18/01	15	\$200M Pending
6	XM-1	5/8/01	15	\$200M Pending

Table 7.7: BSS-702 Spacecraft Susceptible To Early Solar Array Degradation

7.3.6.3 Space Systems / Loral Solar Arrays

In early 2001 Space Systems / Loral reported that eleven orbiting FS-1300 geosynchronous communications satellites could be affected by short circuits in their solar arrays [30]. The solar arrays for these spacecraft do not appear to be degrading as rapidly as the BSS-702s, but this group could also be a worthwhile set of targets for servicing. The spacecraft that could be affected along with their launch date, combined launch and manufacturing costs, and nominal end of life are shown in Table 7.8. Both Tempo 2 and PAS 6 have already had significant solar array related insurance claims filed.

7.3.7 Failed Spacecraft Relocation

A number of spacecraft fail in their operational orbits. This means that they will then present a collision hazard to other spacecraft in that operational area. For the GEO ring refer to the analysis in Section 7.5.2.

An analysis of the MEO GPS constellation reveals that there may be some candidates for relocation. Figure 7.14 shows that the six retired GPS satellites with the lowest perigees overlap with the orbits of the active spacecraft. Additional analysis is needed to determine the actual closest approach distances.

The altitudes of the LEO Iridium satellites is shown in Figure 7.15. In this

#	Satellite Name	Launch Date	Cost (\$M)	End Of Design Life
1	Tempo 2	3/8/97	220	2009
2	Telstar 5	5/24/97	220	2009
3	PAS 6	8/8/97	240	2012
4	Telstar 6	2/15/99	220	2011
5	Echostar 5	9/23/99	205	2011
6	Telstar 7	9/25/99	230	2011
7	Orion 2	10/19/99	250	2014
8	Sirius-1	6/30/00	235	2015
9	EchoStar 6	7/14/00	250	2012
10	Sirius-2	9/5/00	230	2015
11	Sirius 3	11/30/00	230	2015

Table 7.8: FS-1300 Spacecraft Susceptible To Early Solar Array Degradation

case it also looks like there are six inactive satellites near the active orbital region. There are also two Globalstar satellites that have failed, but they are not near the rest of the constellation. Clearing the failed Iridium satellites away from the active satellites probably bears further scrutiny.

A GEO or MEO relocation servicer would need to be able to capture a tumbling satellite and alter its orbital altitude by tens to hundreds of kilometers away from the active orbits. For a LEO relocation servicer, in addition to relocation, re-entry is another option. The existence of such a servicer would allow spacecraft in any orbital regimes to expend more of their fuel for productive operations versus reserving some fuel for end of life maneuvers.

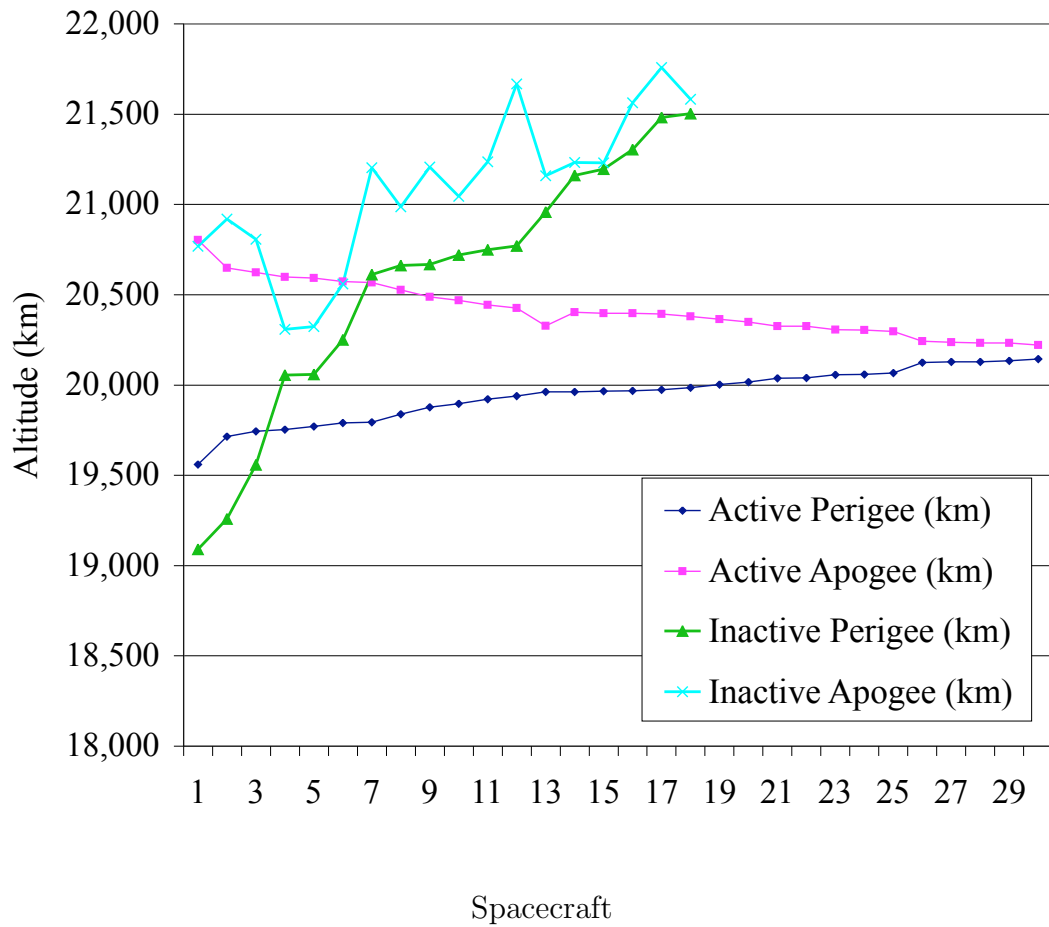
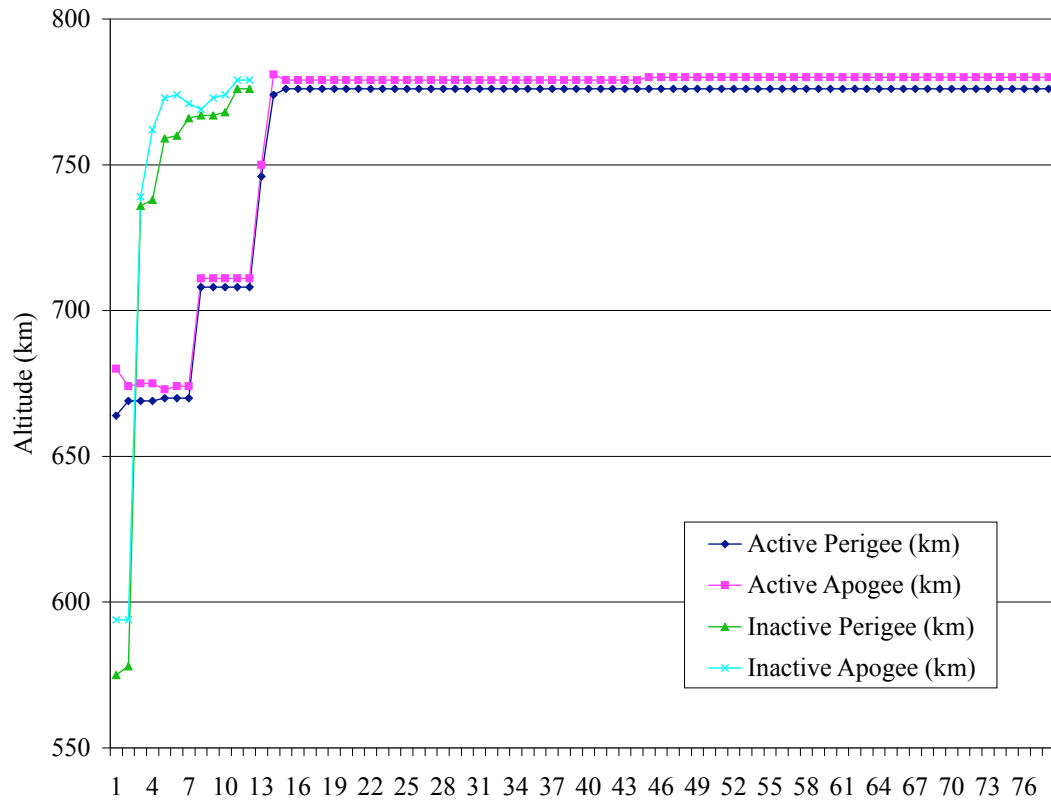

Figure 7.14: Perigees And Apogees For Active And Inactive GPS Satellites



Spacecraft

Figure 7.15: Perigees And Apogees For Active And Inactive Iridium Satellites

7.3.8 Observations Concerning Serviceable Failures

Identifying the demand for services is an essential concern for a servicing organization. Part of this is orbital location. Because of the propulsive requirements for transitioning between LEO, MEO, and GEO, a count of how the opportunities break out by orbit is needed. Table 7.9 shows the count of potentially serviceable failures by orbit that occurred over the 20 year span from 1984 to 2003. Unserviceable failures are omitted (explosion, re-entry, etc.) as are Russian and Chinese government spacecraft due to lack of detail. Failures indicated are first failures per satellite. Additional failures may have occurred but are not included in order to avoid double counting. This table indicates that the most reported failure opportunities occur in GEO, less than half of that count occur in LEO, and a very few are reported in MEO.

The financial investments vary significantly by orbit. Figure 7.16 shows the total investment (satellite, launch, and other reported program costs) and active satellites by orbit for the year 2003. This graph consists of potentially serviceable spacecraft which were active in 2003 and had reported information on total costs as well as other life time information. This graph shows that LEO (198 active satellites) and GEO (326 active satellites) are far more populated than MEO (31 active satellites). The graph also shows that the average investment per spacecraft in GEO is \$216 versus \$116 in LEO. While these are sunk costs and not future revenue streams, these numbers do tend to focus economic analysis towards the GEO market.

Collecting the failure information previously reported, the overall rates at which certain types of failure occur as a fraction of total failures are shown in Ta-

Orbit	Serviceable Failures
LEO	40
MEO	3
GEO	95

Table 7.9: Serviceable Failures By Orbit (1984 To 2003)

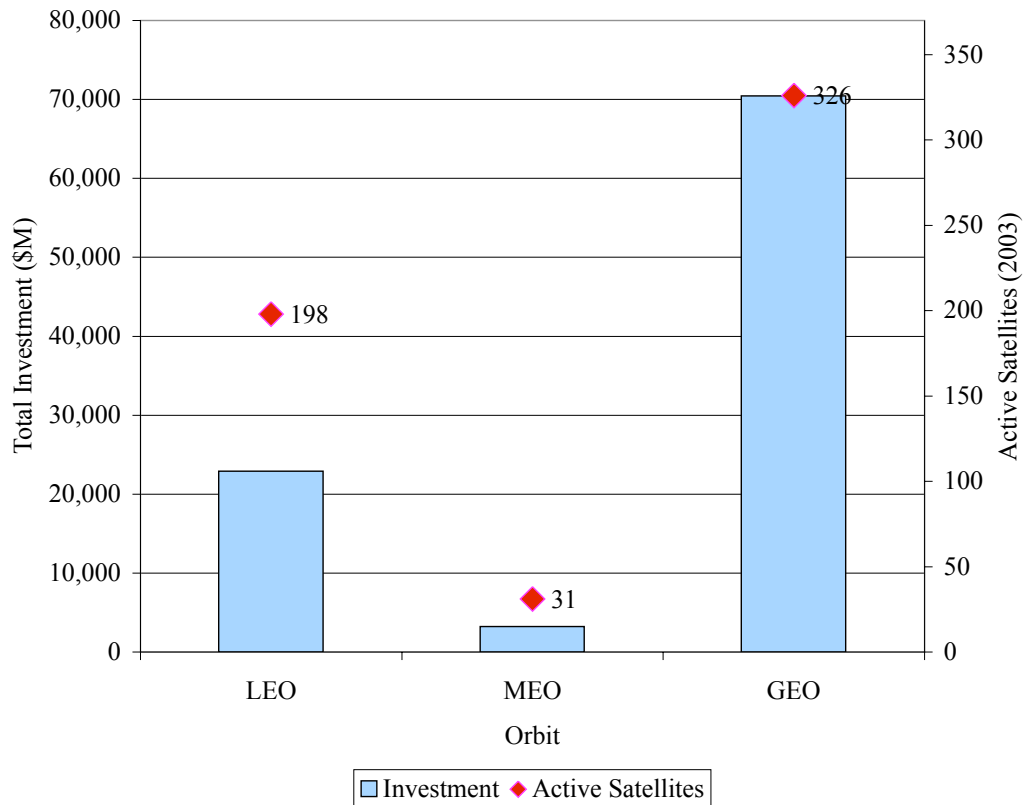

Figure 7.16: Total Investments And Active Satellites By Orbit - 2003

ble 7.10. The “Service Required” column indicates what level of dexterous servicing was needed to mitigate the reported failure. “Simple Dexterous” failures included external-only operations, typically an antenna or solar array deployment malfunction. “Refuel” failures occurred when spacecraft either prematurely depleted their fuel supplies or suffered a propulsion system failure such as a xenon ion primary propulsion system failure. The “Inspection” category includes spacecraft known to have suffered some collision damage (from fairings or upper stages) or to have suffered from an unknown failure. Such inspection missions are not meant to indicate that the problem would have been mediated, but rather that this would be a necessary first step to assess the spacecraft for further, likely dexterous, repairs if warranted.

“Boost” indicates that the spacecraft was delivered to the wrong orbit. The remaining “Complex Dexterous” failures include internal component repairs such as failed momentum wheels, spacecraft control processors, and so forth.

The information from this table in isolation tends to lead towards initially developing a very capable, dexterous servicer in order to meet the large percentage of failures that require a high level of robotic capability. However, other servicing opportunities beyond failure servicing exist. In the next section, lifetime extension servicing opportunities will be examined.

Service Required	Percent Of Failures
Complex Dexterous	57.4
Boost	17.7
Inspection	12.1
Refuel	7.8
Simple Dexterous	5.0

Table 7.10: Failures By Required Service Type

7.4 Spacecraft Lifetime Extension

As noted in Section 1.1.2, the majority of costs involved in geostationary telecommunications satellite business occur up front. Methods to extend the life of these and other spacecraft should be of interest if these methods cost less than launching new satellites and have a similar probability of success. The following sections examine some of the options for extending the life of spacecraft on-orbit.

7.4.1 Relocation

7.4.1.1 Delivery To Initial Orbit

As seen in Section 7.3.1.1, some spacecraft that are delivered to the wrong orbit utilize onboard lifetime fuel to achieve geosynchronous orbit. Once the rescue of such satellites by a servicer was demonstrated, this orbital transfer capability could be extended to healthy spacecraft as well. Such a service would allow the spacecraft to shift initial orbital injection fuel mass to lifetime fuel mass. Other trades such as payload mass versus fuel load could be conducted as well. Andrew Turner of Space Systems Loral has published a paper that address these potential tradeoffs in more detail [97].

7.4.1.2 Geosynchronous Satellite Relocation

Another method for extending the life of a geostationary satellite is to perform rephasing or relocation maneuvers during the operational phase of the satellites life. By extracting satellite location history from The Satellite Encyclopedia Online [14] and Jonathan's Space Report Online [73], a history of GEO spacecraft relocations can be found. Analysis of this history reveals the potential demand for relocation services in GEO over time. Based on data extracted from the sources mentioned, the number of annual maneuvers is shown in Figure 7.17. This includes all GEO communications

satellites. Because the before and after GEO longitudes of the spacecraft are known, the annual degree changes requirement as well and the annual total degrees changed are shown in Figure 7.18. Dividing the annual degrees by the annual maneuvers results in an average of 36.2 degrees per maneuver. Also from the figures, there is an average of 13 maneuvers per year.

From [39] the ΔV to perform a longitude change in GEO is given by Equation 7.1 where $\Delta\lambda$ is the change in longitude and n is the number of days to accomplish the maneuver.

$$\Delta V = 5.66 \frac{\Delta\lambda}{n} \quad (\text{m/s}) \quad (7.1)$$

From this ΔV equation, the fuel mass required for the maneuver may be calculated from the form of the rocket equation shown in Equation 7.2 [106]. Where m_p is the mass of fuel used in the maneuver, m_o is the mass of the vehicle at the start of the burn, I_{sp} is the specific impulse of the fuel being burned (typically 220 seconds), and g_0 is earth's gravitational constant (9.81 m/s^2).

$$m_p = m_o \left[1 - \exp^{-\left(\frac{\Delta V}{I_{sp}g_0}\right)} \right] \quad (7.2)$$

For a typical GEO satellite, such as Superbird 4 (with a BOL on-orbit mass of 2,460 kg) the annual station-keeping fuel budget is about 60 kg, or 5 kg per month, or 0.16 kg per day. Knowing this burn rate enables a direct trade between fuel mass and time out of service. Total time lost, T_{Total} , is shown in Equation 7.3, where $T_{ManeuverDuration}$ is the duration of the maneuver in days and $T_{LifetimeLost}$ is the satellite lifetime lost due to the expenditure of station-keeping fuel for relocation. The equation may be reformulated as Equation 7.4.

$$T_{Total} = T_{ManeuverDuration} + T_{LifetimeLost} \quad (7.3)$$

$$T_{Total} = n + m_o / (0.16(\text{kg} / \text{day})) \quad (7.4)$$

Substituting Equation 7.2 for m_o and solving empirically, a minimum for T_{Total} is found to be 76.4 days (or 2.5 months), where n is 37 days, and m_p is 6.3 kg of fuel. With an average monthly revenue of \$3.7M, this maneuver costs a total of \$9.2M. While this full amount cannot be recovered, at least the fuel half of it can be provided by a servicer. Therefore, on an annual basis, if there are 13 relocations costing \$4.6M each, a savings of about \$60M per year is possible.

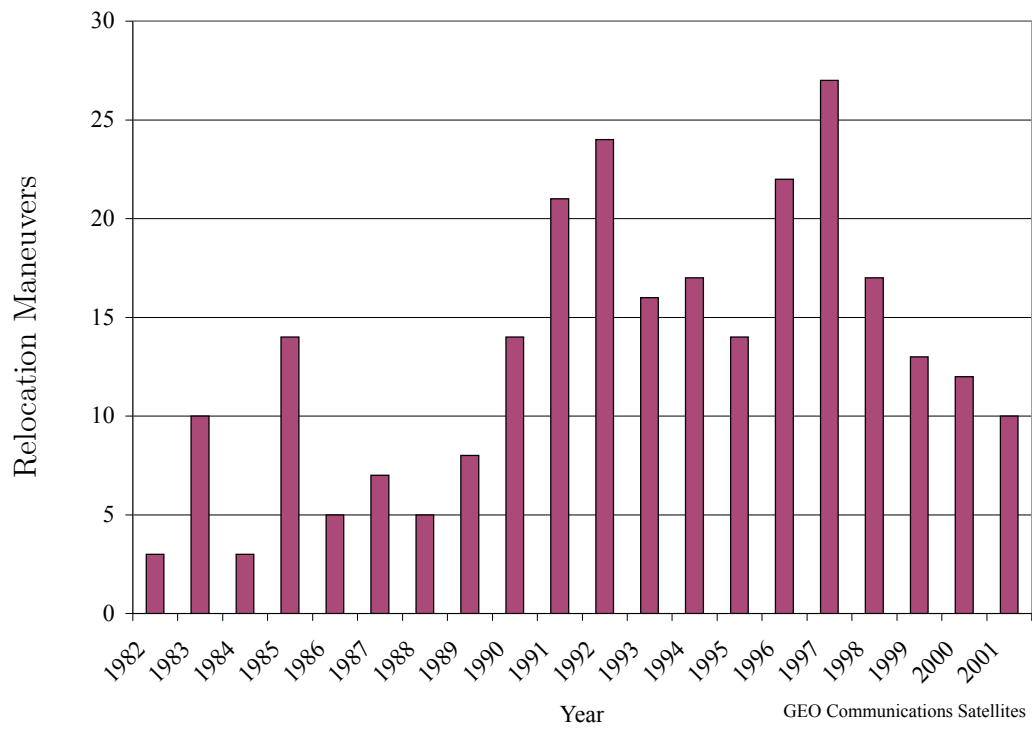

Figure 7.17: Annual GEO Relocations

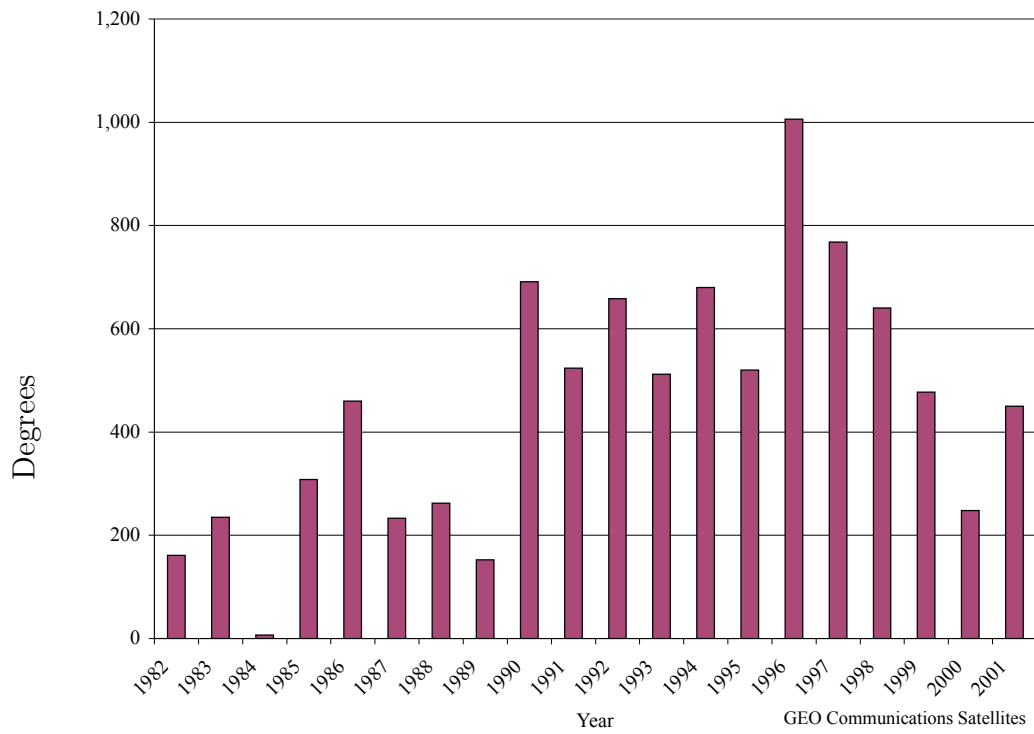

Figure 7.18: Annual GEO Relocations Degrees

7.4.1.3 Transfer Out Of GEO Orbit

By international convention (but not law) and by FCC ruling [49], when GEO satellites are retired, they are required to maneuver away from GEO. To avoid interference with working spacecraft they are sent to a higher orbit. While the FCC rule is that the new perigee must be a minimum of 200 km above GEO, some international space organizations advocate a 350 km limit. For analysis purposes a 300 km limit will be used here. In order to find how much of a savings a retirement service could provide, the fuel mass a typical GEO satellite requires to perform its retirement maneuver must be found. That value is then compared to the satellite's monthly station-keeping fuel budget.

Analysis shows that the fuel for this maneuver can be traded for about three months of operational life for GEO satellites. Fuel gauging uncertainties makes the retirement fuel mass reserve even larger. The GEO communications satellites that have retired over the twenty year span from 1984 through 2003 are shown in Figure 7.19. They were retired at a rate of 7.5 per year over this period and at a rate of 9.1 over the last 10 years. Again, Russian and Chinese spacecraft are excluded due to lack of detailed data. Looking ahead as shown in Figure 7.20, there will be 16.9 retirements per year on average for the years 2004 through 2015 based solely on design life. Additionally, there are a number of spacecraft currently operating beyond their design lives. The commercial geosynchronous communications satellites in this class are shown in Figure 7.21. The military and civilian satellites are shown in Figure 7.22. Most members of this combined group of 52 spacecraft will likely also be retired over the course of the next decade and represent additional servicing opportunities.

Based on these communications satellites and the additional weather and intelligence satellites, there will probably be 15 to 25 retirements per year over the next decade. Providing a GEO retirement maneuver service will save approximately three months of fuel per satellite. Overall, this implies that an additional 60 vehicle-months

of operations for high value GEO satellites per year could be provided.

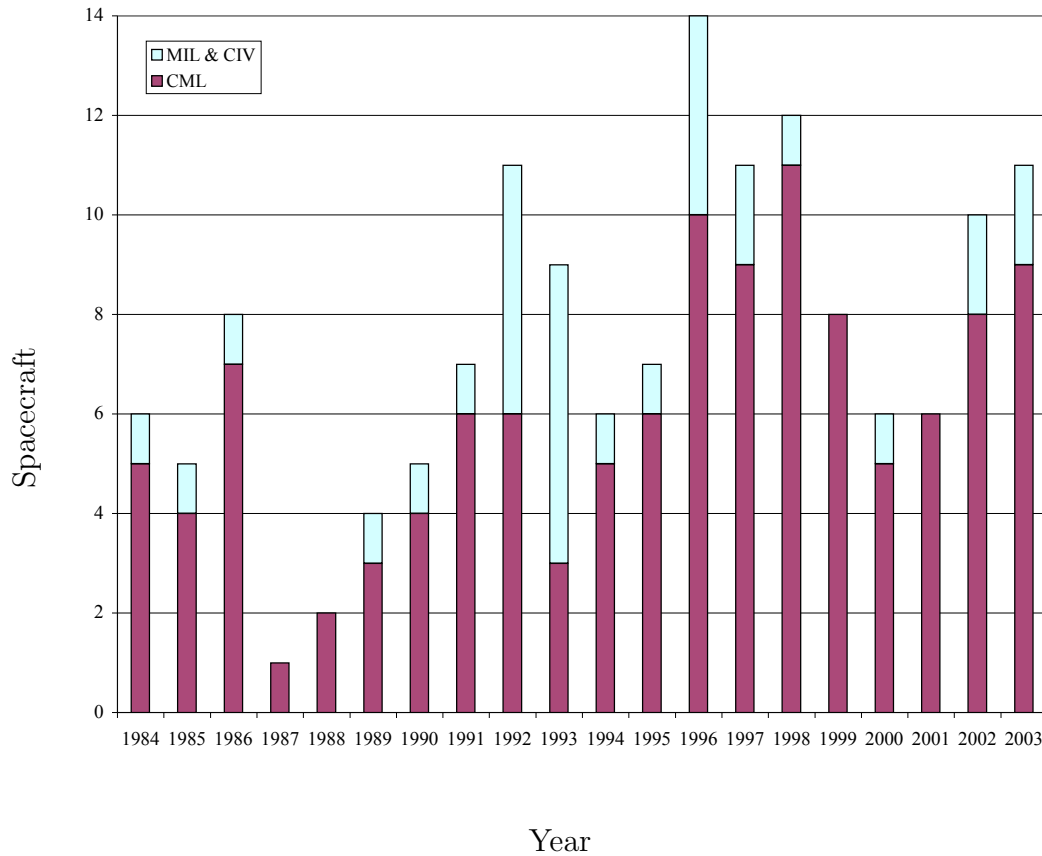

Figure 7.19: Geosynchronous Communication Spacecraft Retirements From 1984 To 2003

7.4.1.4 De-Orbit Maneuver

Because retired LEO spacecraft can end up entering the earth's atmosphere, they are often commanded to de-orbit in a controlled manner at the end of their design life to minimize the chance of their impacting an inhabited area. The ΔV required for de-orbit is significant and requires a substantial portion of the spacecraft's fuel budget. Providing a de-orbit service could extend the life for a typical LEO spacecraft, such as an Iridium communications satellite. The annual fuel budget for an Iridium spacecraft

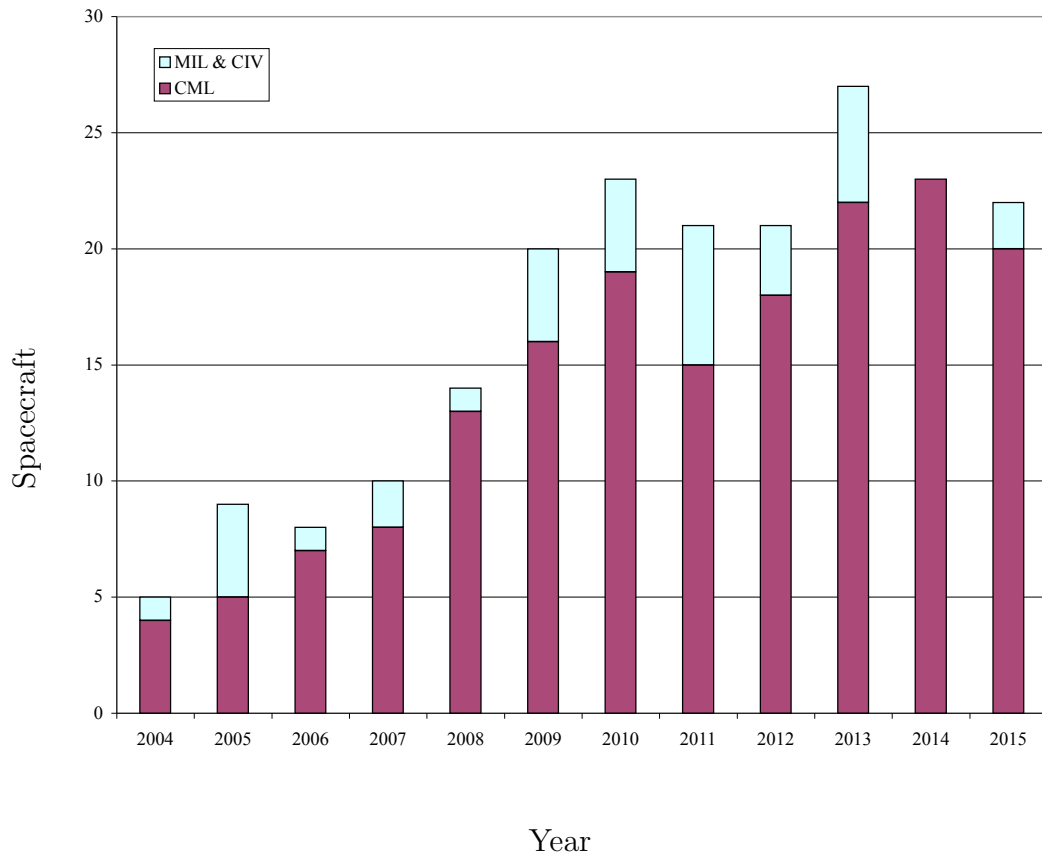

Figure 7.20: Geosynchronous Communication Spacecraft To Retire From 2004 To 2015

is 0.725 kg, as seen in Table 7.11. A LEO de-orbit service for Iridium satellites would allow these spacecraft to convert their 18.0 kilograms of decommissioning fuel into 24.8 years of operational life. While the design life for these buses is only 5 years, some have already been operating for 7 years. With a combined \$16M launch and manufacturing cost per satellite, a low cost disposal method would seem to be worth investigating further.

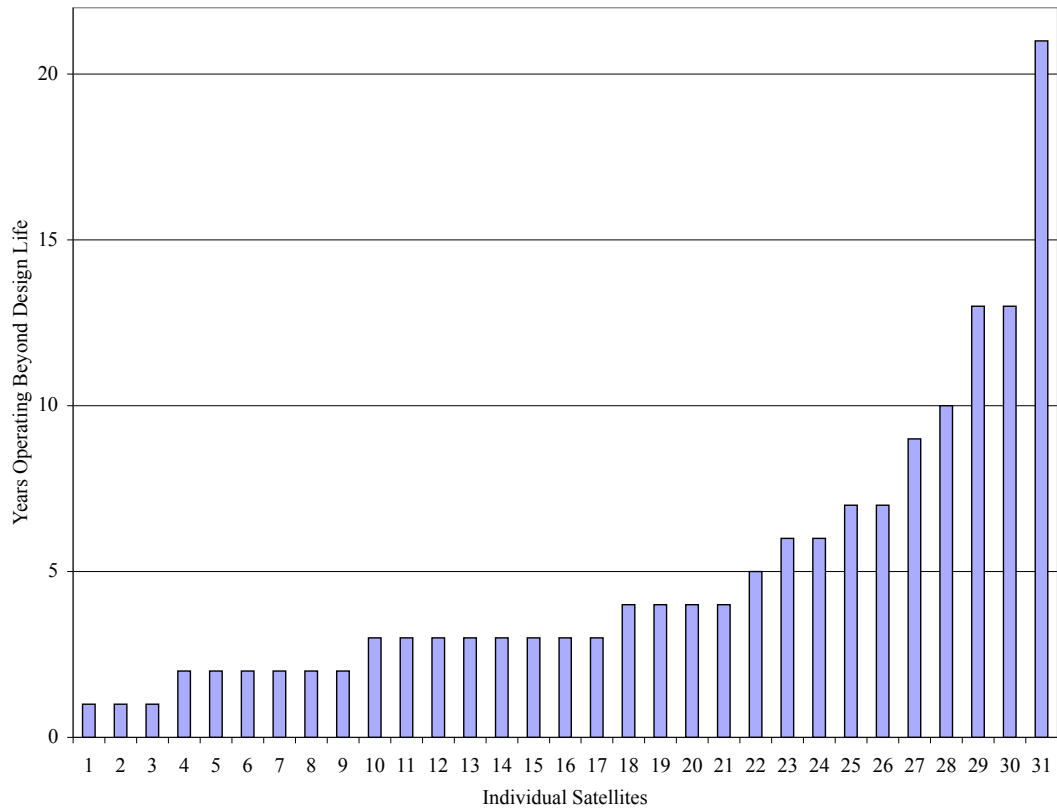

Figure 7.21: Commercial Geosynchronous Communication Spacecraft Operating Beyond Design Life In 2004

7.4.2 Refueling

Most geosynchronous spacecraft reach the end of their station-keeping fuel before other major systems start to fail [57]. Examining the satellite information database, a number of trends in geosynchronous spacecraft lifetimes can be seen.

Of particular interest is the set of geosynchronous communications satellites launched since 1980 which have reached end of life. They have on average exceeded their design life by 24%. This yielded an average additional 1.6 years of service past their design life. Figure 7.23 illustrates the actual life of geosynchronous communications satellites versus their design life. This analysis includes all geosynchronous

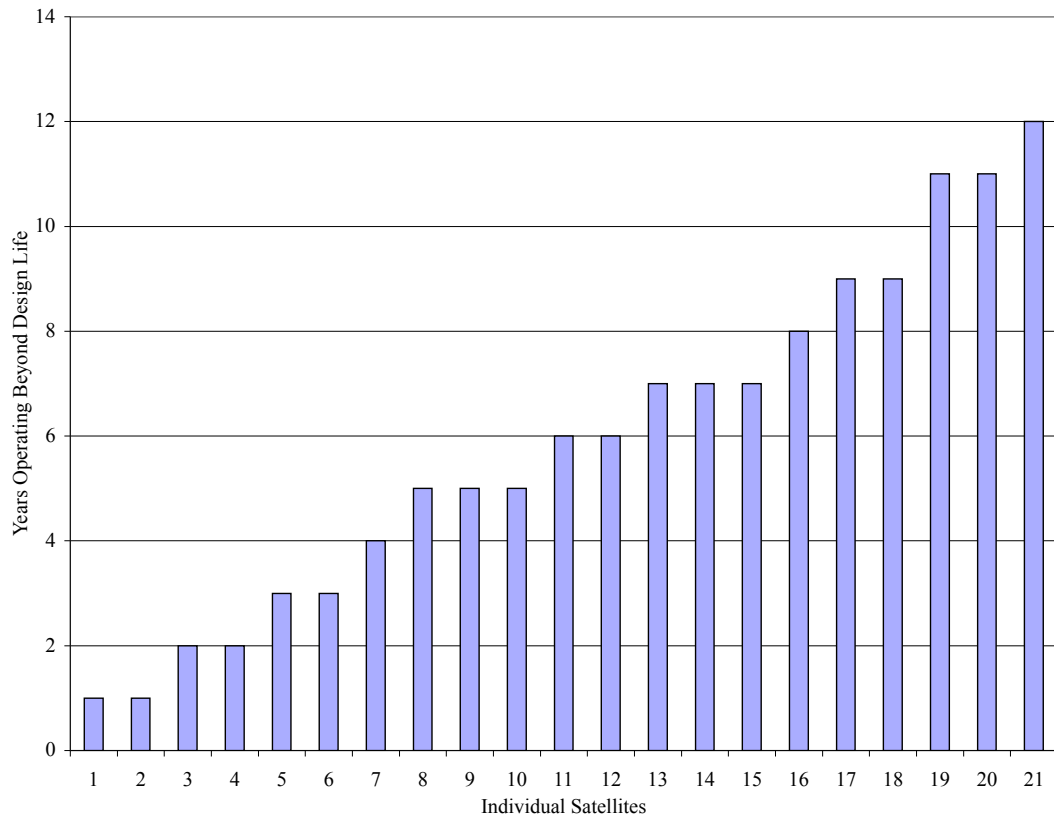

Figure 7.22: Civilian And Military Geosynchronous Communication Spacecraft Operating Beyond Design Life In 2004

communications satellites launched since 1980 which have since become inactive (minus the Russian and Chinese government satellites). The figure shows a cross over point at the 31st spacecraft. All of the satellites before the 31st ended their useful lives before the end of their design lives. Satellites to the right of the 31st all exceeded their design life. Another view of this result is shown in Figure 7.24, in which the lifetime surplus or shortfall is normalized versus the nominal design life.

A subset of the previous set includes geosynchronous communications satellites launched since 1980 which have reached end of life and which have operated in an inclined mode. These spacecraft have on average exceeded their design life by

Event	Fuel Mass (kg)	Note
Orbit Insertion	17.5	Initial Maneuver
Orbit Trim	2.2	8 Years Worth
Drag Makeup	3.6	8 Years Worth
Decommission maneuver	18.0	Final Maneuver
Total Fuel Load	41.3	Of 689 kg Total Spacecraft Mass

Table 7.11: Iridium Fuel Budget

30%. This yielded an average additional 2.0 years of service past their design life. Figure 7.25 shows the breakout between design and extended life and between un-inclined and inclined operations. An additional criterion for this set was that they at least reached their design life before retiring. Un-inclined operations allow a greater number of simpler ground stations to utilize the spacecraft services, generating the maximum communications satellite revenues. Inclined operations generate significant but reduced revenues. The inclined years of operation represented here amount to about 200 spacecraft-years. Calculating the exact amount of revenue that could have been realized by refueling these spacecraft is problematic. To find a floor on this value, it can be conservatively estimated that inclined operations generate at least 20% less than the revenue of un-inclined operations (about \$44.4M per GEO communications satellite per year as shown in Appendix B). Given this loss of \$8.8M per satellite per year and 200 years of inclined operations, the order of magnitude of the opportunity to refuel inclined mode satellites is \$1.8B over those years. Of course the effect of increased supply on the transponder market would in turn drive the prices down.

While refueling these inclined mode spacecraft represents a substantial opportunity, it does not include fully functional spacecraft that transitioned directly from un-inclined active operations to a graveyard orbit.

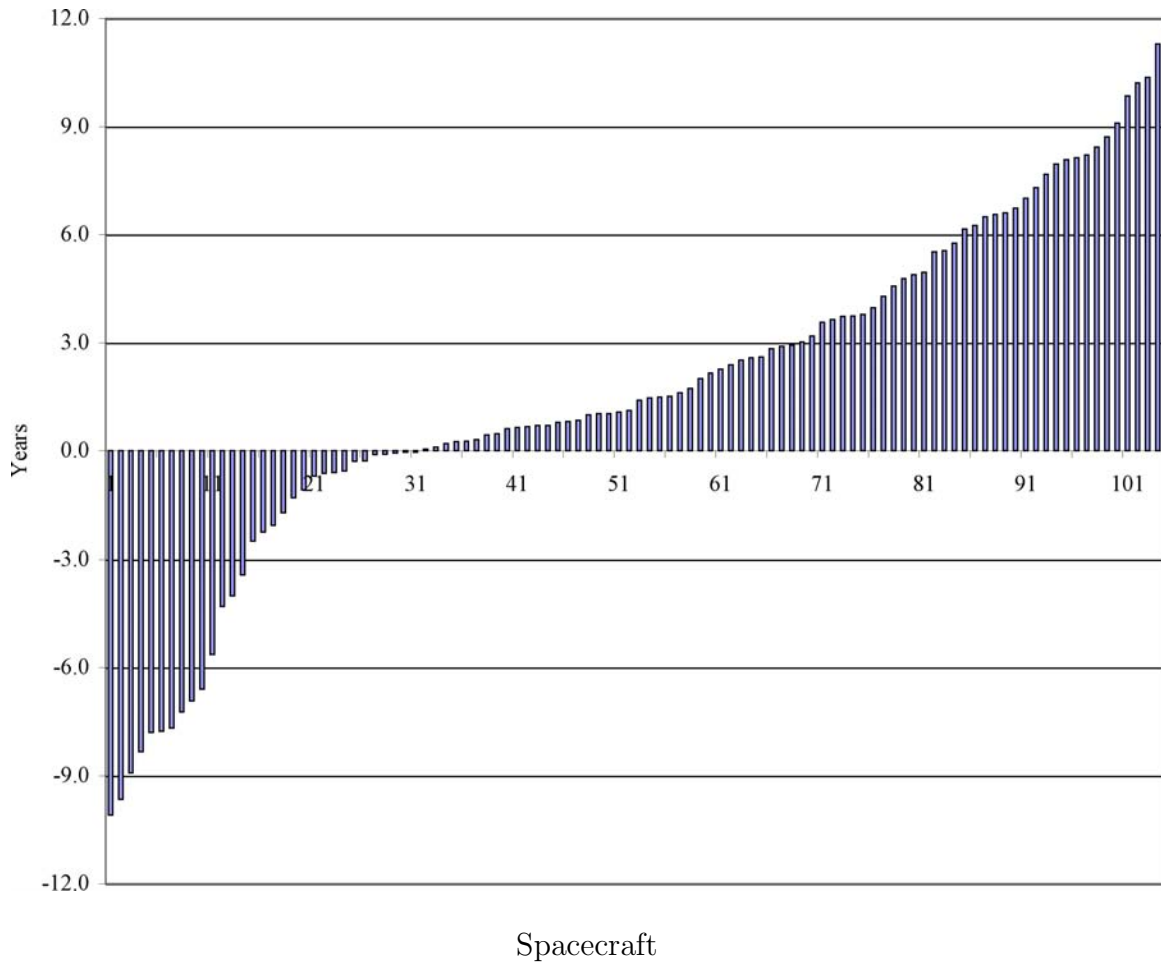

Figure 7.23: Years Actual Life Exceeded Design Life For Retired Geosynchronous Communications Satellites Launched Since 1980

7.4.3 Consumables Replenishment

The 1999 failure [14] of the \$90M WIRE (Wide-Field Infrared Explorer) spacecraft points to the opportunity to resupply scientific spacecraft with consumables. In the case of WIRE, a LEO astronomy satellite, when the spacecraft was activated, a power surge prematurely triggered explosive bolts, which then deployed the cover of the infrared telescope. Solid hydrogen needed to cool the system sublimated and vented, causing the spacecraft to spin out of control. Control was later regained, however, by then the hydrogen supply had been depleted. Coolant is used on a number of

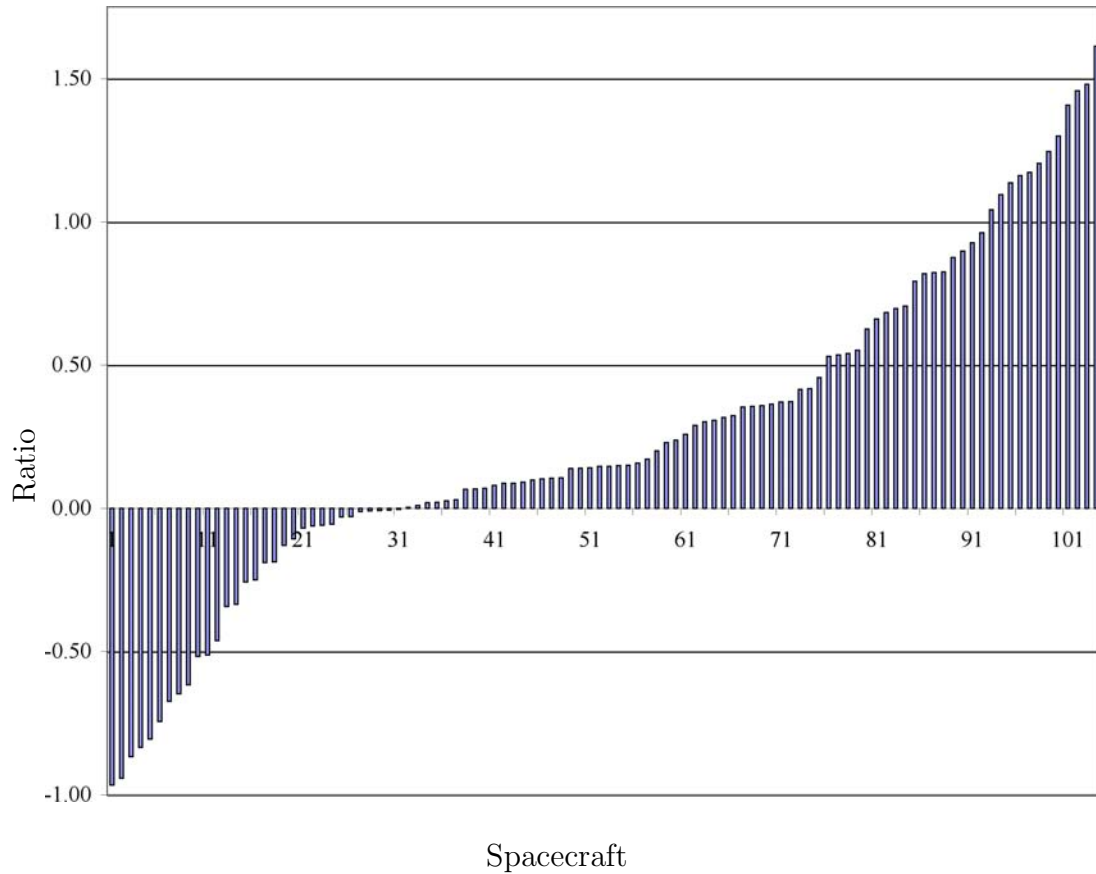

Figure 7.24: Ratio Of Active Life Beyond Design Life To Design Life For Retired Geosynchronous Communications Satellites Launched Since 1980

satellites to enable sensitive sensors. A cryogen supply vehicle could enable longer life or lower launch mass for such high-value spacecraft.

7.4.4 Preventative Maintenance

For components common on a number of spacecraft, MTBF information can be collected over time. This component level information could be used to predict failures. Were more of this level of information available, proactive replacement of key spacecraft components would likely be a valuable service.

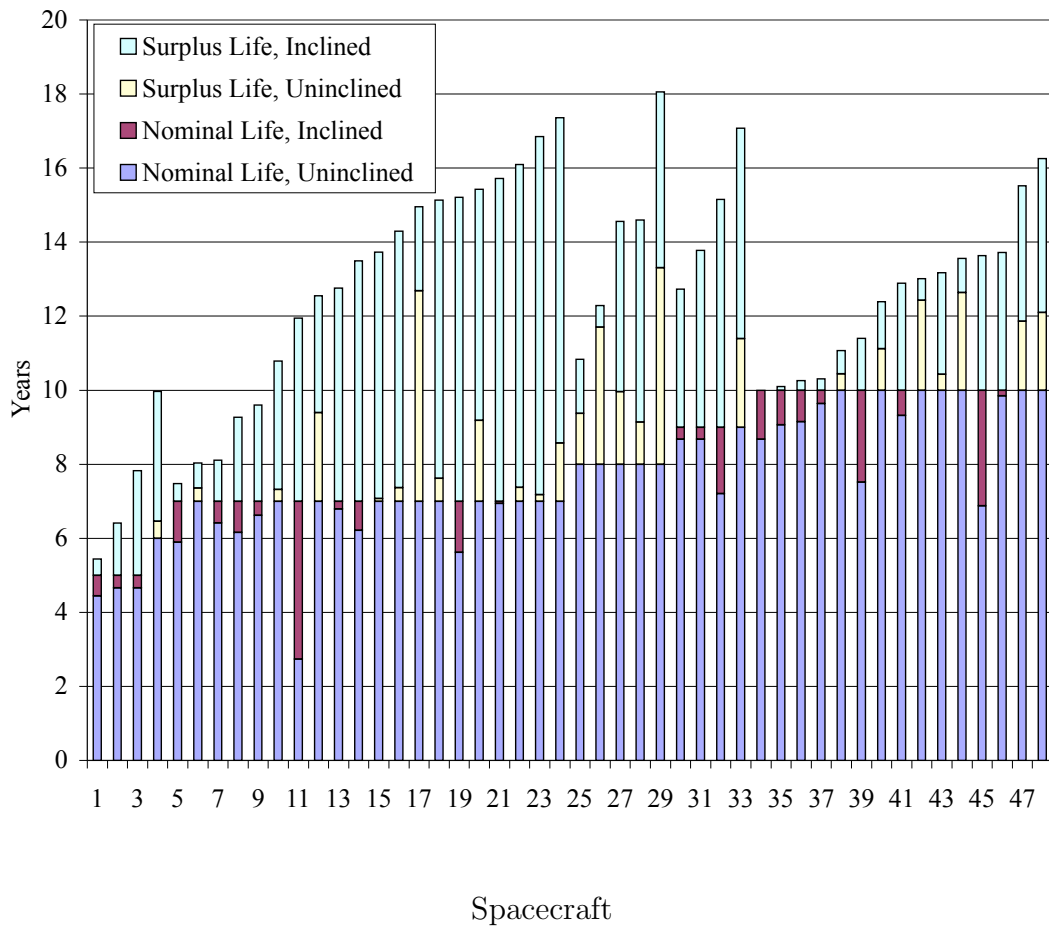

Figure 7.25: Actual And Design Life For Retired Geosynchronous Communications Satellites Launched Since 1980 That Functioned Inclined While Active

7.4.5 Spacecraft Upgrade

The ability to add more capable sensors, instruments, or other payloads to existing spacecraft could extend the useful life of functioning satellite buses with obsolete payloads. Leisman studied this extensively for the GPS constellation [69].

7.4.6 Optical Surface Maintenance

A number of scientific satellites, including Chandra, Stardust, Cassini, and others, have accumulated contaminants on optical surfaces. In most cases heaters or exposure

to direct sunlight has removed these substances. The ability to clean or repair such optical surfaces could someday provide a mission saving service. Because of the infrequency of occurrence, this type of servicing capability would be a secondary or tertiary capability on a servicer with another primary mission.

7.5 Other Services

Beyond servicing failures and extending spacecraft life, other services are conceivable, including inspection and relocation.

7.5.1 Inspection

7.5.1.1 Initial Deployment

In February 2000, the Hughes constructed Galaxy XI (model BSS-702) was the first commercial satellite to include onboard cameras to monitor solar array deployment. The 30 minute deployment sequence was recorded and downlinked to verify operation of the new solar array configuration. This is a clear demonstration that satellite operators see a need to monitor spacecraft during deployment activities. The deployment anomalies discussed in Section 7.3.2 also argue for such a capability. A servicer, with a primary mission tied more directly to a financial benefit could readily provide this ability as a secondary servicing mission capability.

7.5.1.2 Health Monitoring

Another inspection task is to periodically check the external condition of a satellite (solar array degradation, micro-meteor damage, etc.). The Boeing and Loral solar arrays mentioned previously would be likely candidates for such a service. A number of spacecraft, such as CHAMP in 2000 and Telstar 6 in 2002, also experienced significant micro-meteor impacts. Inspection of damage from such impacts would provide valuable information on assessing the affect on spacecraft longevity.

7.5.1.3 Insurance Investigation

Visual validation of multi-million dollar insurance claims also seems like a likely use for an inspection vehicle.

7.5.2 Debris And Failed Spacecraft Relocation

A number of studies ([88], [55], [56], [89], [85], [84]) make the case for increasing concern regarding the effect of the orbital debris environment on active spacecraft. Imposing the requirement for disposal maneuvers on future spacecraft is a useful approach, but numerous satellites have already failed in or near working orbits. While removing these collision hazards from active orbits benefits all of the other spacecraft in such orbits, no revenue is produced directly from this activity. Such a service appears to be a useful secondary mission for a servicer.

Of particular interest is the geostationary orbit. Because all these (about 250) high-cost, high-revenue spacecraft share the same orbit, clearing away failed spacecraft, rocket bodies, and other orbital debris is evolving from a good idea into a necessity. Table 7.12 lists the 16 objects which pass within 1 kilometer of GEO. Each of these objects is a satellite except for the IUS R/B, which is an Inertial Upper Stage rocket body. All of these objects are of substantial mass and would inflict serious damage in the event of a collision with a working satellite. The Figures 7.26, 7.27, and 7.28 illustrate the nearest hazards. There are 63 objects which pass within 5 kilometers of GEO. Expanding the buffer out to 50 kilometers, there are a total of 175 objects. Currently, collision avoidance is managed with the help of ground radars. In some cases, spacecraft maneuver to avoid collision. Removing the hazards to a safer distance would provide an additional benefit by eliminating the need for such fuel expenditures.

The objects described have accumulated over the years. Figure 7.29 shows the number of new objects arriving near (within 200 km) of GEO per year. An average of 10.5 objects were added annually over the twenty years from 1984 to 2003.

#	Satellite Name	ID	Source	Inc. (deg)	Perigee (km)	Apogee (km)	Dist. To GEO (km)
1	FltSatCom 4	1980-087A	US	13.5	35,767	35,805	0.13
2	IUS R/B(2)	1991-054D	US	9.4	35,649	35,923	0.31
3	FltSatCom 3	1980-004A	US	12.4	35,673	35,900	0.33
4	Raduga 6	1980-016A	CIS	14.4	35,763	35,808	0.37
5	Raduga 26	1990-112A	CIS	8.1	35,764	35,807	0.37
6	GSTAR 1	1985-035A	US	6.0	35,756	35,817	0.62
7	Raduga 14	1984-016A	CIS	12.2	35,771	35,802	0.63
8	NATO 2B	1971-009A	NATO	14.3	35,773	35,800	0.64
9	Satcom C5	1982-105A	US	9.0	35,772	35,801	0.64
10	Cosmos 2085	1990-061A	CIS	8.3	35,779	35,794	0.64
11	GSTAR 3	1988-081A	US	11.5	35,775	35,798	0.64
12	GOES 7	1987-022A	US	8.2	35,779	35,794	0.64
13	Koreasat 2	1996-003A	SKOR	0.1	35,783	35,790	0.64
14	Skynet 1	1969-101A	UK	13.4	35,678	35,896	0.86
15	Intelsat 3-F3	1969-011A	ITSO	6.1	35,767	35,803	0.87
16	Cosmos 775	1975-097A	CIS	14.6	35,736	35,834	0.92

Table 7.12: Objects Which Pass Within 1 km Of GEO

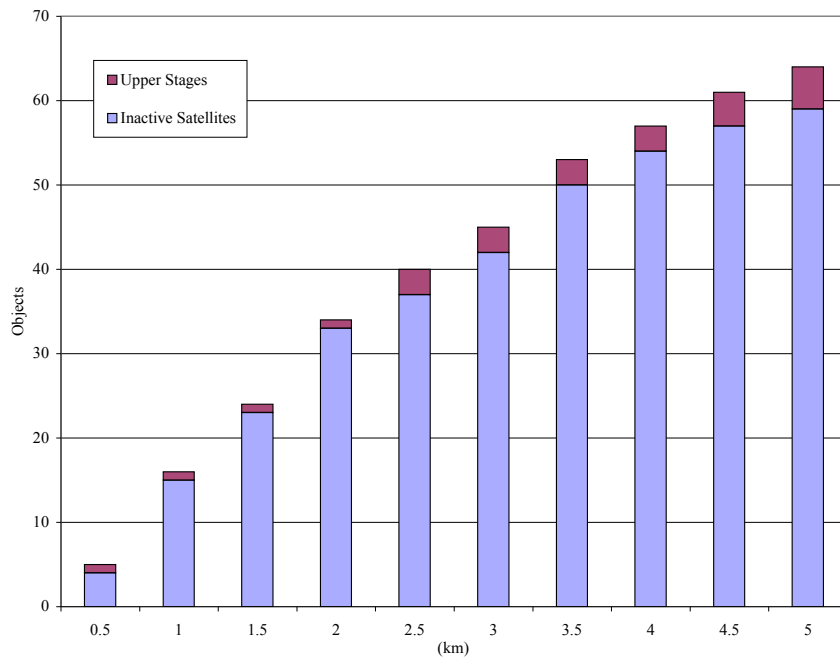

Figure 7.26: Objects Which Pass Within 5 km Of GEO

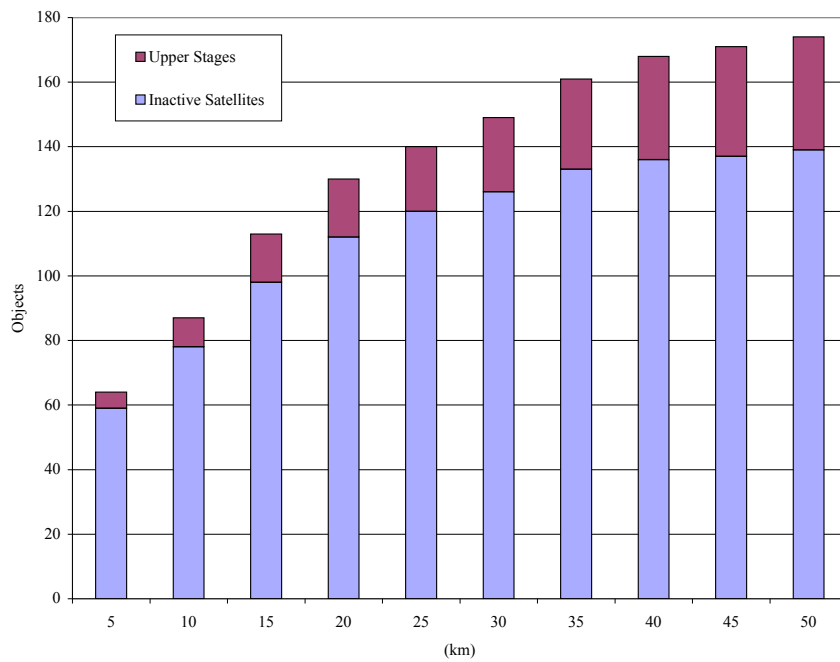

Figure 7.27: Objects Which Pass Within 50 km Of GEO

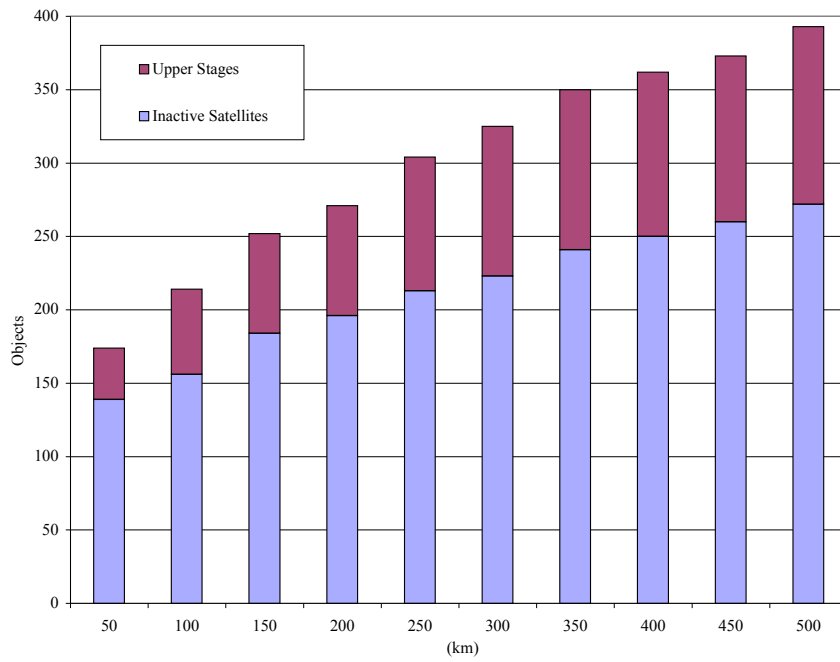

Figure 7.28: Objects Which Pass Within 500 km Of GEO

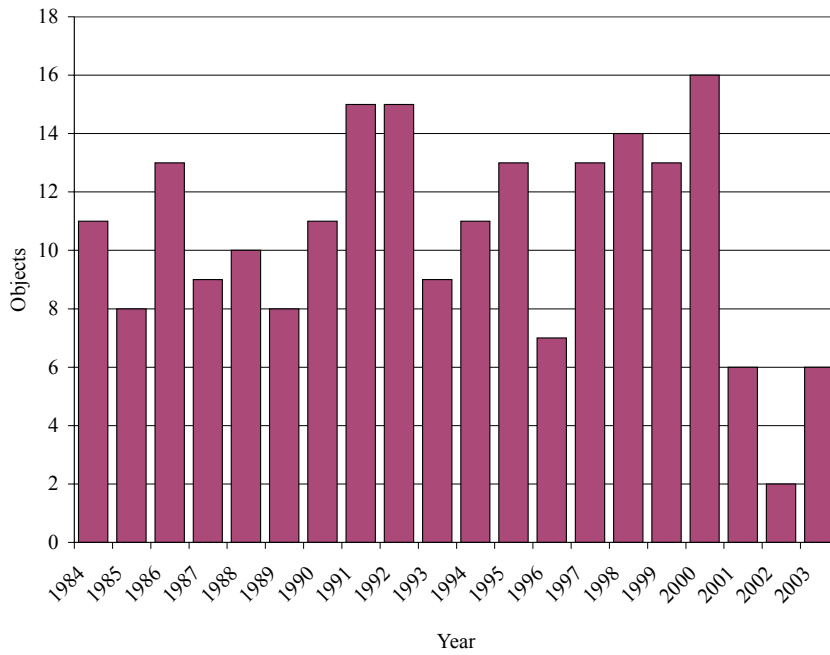

Figure 7.29: Annual New Inactive Objects Passing Within 200 km Of GEO

7.6 Summary Of Opportunities

In order to begin to rank the servicing opportunities identified earlier in this chapter, discriminating factors need to be identified. Table 7.13 shows the missions and information on their targets. Target Status indicates in what phase of life the satellite is. BOL is beginning of life. Midlife is during the nominal design life. Near EOL means operational but approaching retirement. Inactive means that the spacecraft has ceased functioning. The Remove Inactive mission includes removing both inactive spacecraft and other orbital debris near GEO. The Benefit column indicates what the benefit of a successful servicing would be. Servicing satellites with BOL issues will enable a large (possibly around 90%) fraction of the full life to be achieved. The Extends Life benefit indicates that the service will allow a functioning satellite to continue operations. The Remove Inactive benefit is that it reduces the collision hazard to active spacecraft in GEO. The Annual Events column lists how many servicing opportunities are available in any particular year. Further economic valuation of these missions in conjunction with operational uncertainties is presented in detail in the next chapter.

Mission	Target Status	Benefit	Annual Events
LEO to GEO Transfer	BOL	Enables Full Life	1.1
Retirement Maneuver	Near EOL	Extends Life	20
Relocate In GEO	MidLife	Extends Life	13
Remove Inactive	Inactive	Prevents Damage	10.5
Deployment Monitoring	BOL	Enables Full Life	20
Health Monitoring	MidLife	Issue Detection	200
ORU-like Repair	MidLife	Extends Life	4.4
General Repair	MidLife	Extends Life	3.8
Deployment Assistance	BOL	Enables Full Life	0.3
Refuel	MidLife	Extends Life	20

Table 7.13: Candidate Servicing Missions

Chapter 8

Expected Value Of Servicing Market Segments

Having identified numerous servicing opportunities and substantial financial incentives in Chapter 7, the question becomes which missions to pursue first. The candidate missions from Table 7.13 are summarized below, and subsequent sections will determine the expected-value break-even servicing fee for each case based on the approach outlined in Chapter 4. The majority of these opportunities involve satellites in geosynchronous orbit, therefore, those satellites will be examined first and the results will be extended where applicable to LEO and MEO spacecraft.

1. **LEO to GEO Transfer** - The servicer docks to a target in LEO or GTO and boosts it to GEO. This enables nearly full lifetime for target.
2. **Retirement Maneuver** - Servicer docks to target and removes it from GEO. Allows target to burn relocation and margin fuel for extended lifetime.
3. **Relocate In GEO** - Servicer docks to target and relocates in GEO. Saves both time out of service and fuel expenditure for relocation.
4. **Remove Inactive** - Servicer captures an inactive spacecraft or other orbital debris and removes it from GEO. Reduces collision hazard.
5. **Deployment Monitoring** - Servicer provides video downlink of deployment

operations. Gives ground controllers additional information to resolve deployment anomalies.

6. **Health Monitoring** - Inspection provides additional health status information to ground controllers. Allows better prediction of satellite performance over time and identifies impending problems.
7. **ORU-like Replacement** - Servicer docks with target and may or may not remove old failed components. Servicer adds replacement components to target to overcome failures.
8. **General Repair** - Servicer docks with target and performs complex, dexterous robotic servicing tasks beyond simpler ORU-level tasks.
9. **Deployment Assistance** - Servicer docks with target and uses manipulators to assist stuck appendage to deploy.
10. **Refuel** - Servicer docks with target. Manipulators access port for fuel transfer. A subtype of this servicer docks and provides propulsions services instead of transferring fuel.

The following sections examine the expected value equation (from Chapter 3) for each mission. The probabilities for each chance node outcome are discussed in Section 8.1. A summary of the expected values of the candidate missions is shown in Section 8.3.

The servicing break-even fee derived in follow sections is the fee that drives the net benefit of servicing to zero. Obviously, an actual servicing fee would have to be lower. How much lower is an argument left to others.

8.1 Chance Node Probabilities

Throughout the expected value calculations later in this chapter, a number of event outcome probabilities are identified. These probabilities are explained below. The Launch, Orbital Transfer, Deployment and Graveyard Transfer chance nodes apply to both target satellites and servicers and can be derived from the Satellite Information Database. The rest of the chance nodes apply only to servicers and must therefore be estimated. Where possible, these estimates are based on similar mechanisms or operations that have previously flown in space. The chance nodes listed in Table 8.1 will be examined in the following sections.

Chance Node	Description
Launch Outcomes	Probability of a successful launch
Orbital Transfer Outcomes	Probability of successful transfer from one orbital location to another
Graveyard Transfer Outcomes	Probability of a GEO spacecraft successfully achieving the proper retirement orbit altitude
Deployment Outcomes	Probability appendage deployment success
Docking Outcomes	Probability of successful docking
Undocking Outcomes	Probability of successful undocking
Refueling Outcomes	Probability of successfully refueling a target satellite
Dexterous Repair Outcomes	Probability of performing a successful dexterous operation on a target satellite

Table 8.1: Chance Nodes

8.1.1 Launch Outcomes

Table 8.2 shows the possible outcomes of launching a spacecraft to geosynchronous orbit. Upon launch, a satellite can be destroyed in a launch failure; be delivered to the wrong orbit; achieve orbit but fail before becoming operational; or achieve orbit and successfully begin operations. Satellites that were launched into the wrong orbit but which were able to achieve correct orbit using onboard fuel are not counted here as having suffered a wrong orbit failure. The first three options are derived from

the Satellite Information Database, and the calculation for the final option is shown below in Equation 8.1.

$$pGEOok = 1 - pGEOfto - pGEOwo - pGEOim \quad (8.1)$$

		Parameter	Basis
Total Launch Attempts (1994 to 2003)	772		
Launch Failures	37		
Chance Of Launch Failure	4.8 %	pGEOfto	Sat DB
Satellites Intended For GEO	261		
Satellites Failed In Wrong Orbit	8		
Chance Of Wrong Orbit Failure	3.1 %	pGEOwo	Sat DB
Satellites Delivered To GEO	253		
GEO Satellites Failing In First 30 days.	6		
Chance Of Beginning Of Life Failure	2.4 %	pGEOim	Sat DB
Chance for GEO Success	89.8 %	pGEOok	Sat DB

Table 8.2: Expected Value Probabilities - GEO Satellite Delivery To Orbit

8.1.2 Orbital Transfer Outcomes

Orbital Transfer refers to a satellite relocating itself within the geosynchronous orbital belt. An example of such a relocation would be the movement of GOES-5 from a geostationary location monitoring weather over the Atlantic Ocean to a position over the Pacific Ocean. As seen in Table 8.3, over the course of the last 10 years there have been 172 identifiable satellite relocations in GEO. Some of these maneuvers are from online reports ([73], [14]) and some are from the orbital analysis programs developed by the author and described in Appendix E. A number of additional military satellite maneuvers may have occurred, but their orbital elements are not reported by the NSSDC. Only one active geostationary satellite experienced unexpected propulsion system failure over that time. An additional 3 satellites experienced propulsion system anomalies resulting in premature fuel depletion, but these anomalies were detectable and took time to empty the fuel tanks. The table shows the possible outcomes of orbital transfer and Equation 8.2 shows how $pXferOK$ is found.

$$pXferOK = 1 - pXferFail \quad (8.2)$$

		Parameter	Basis
Satellites Relocations In GEO (1994 to 2003)	172		
GEO Satellite Propulsion Failures	1		
Chance Of Relocation Failure	0.6	pXferFail	Sat DB
Chance Of Successful Relocation	99.4	pXferOK	Sat DB

Table 8.3: Expected Value Probabilities - Orbital Transfer

8.1.3 Graveyard Transfer Outcomes

Graveyard Transfer is a special case of Orbital Transfer and applies to a satellite transferring itself from geosynchronous orbit to a retirement orbit. Until recently,

there was no penalty for leaving a defunct spacecraft in geosynchronous orbit. In order to extract maximum economic output from their satellites, some operators misjudged their retirement maneuver fuel reserve and their spacecraft failed to reach the retirement orbit. Table 8.4 is derived from the Satellite Information Database. 139 spacecraft of all types which operated in geosynchronous orbit became inactive over the 10 year period from 1994 thru 2003. Of these, 69 continue to pass within 200 km (the FCC limit [49]) of geosynchronous orbit. The table shows the possible outcomes of maneuvering to the graveyard orbit and Equation 8.3 shows how $pGYok$ is found. It is granted that once a more serious penalty is regularly imposed, the probability of reaching the graveyard will likely increase.

$$pGYok = 1 - pGYfail \quad (8.3)$$

		Param.	Basis
GEO Satellite Retirement Maneuvers (1994 to 2003)	139		
Inactive Sat.s Passing Within 200 km Of GEO	69		
Chance Of Graveyard Transfer Failure	49.6 %	pGYfail	Sat DB
Chance Of Successful Graveyard Transfer	50.4 %	pGYok	Sat DB

Table 8.4: Expected Value Probabilities - Graveyard Transfer

8.1.4 Deployment Outcomes

At the start of life spacecraft typically deploy solar arrays, antennas, and other appendages. In order to evaluate a deployment monitoring scenario, an value for chance of deployment failure is needed. Over the last 10 years (1994 thru 2003), 253 satellites have arrived successfully in geosynchronous orbit. Of these, 7 (as seen in Table 7.4) have reported experiencing a deployment failure. There maybe more unreported deployment anomalies due to the sparse reporting for military spacecraft. Table 8.5 shows the rates used in this analysis.

	Percent	Param.	Basis
Chance Of Deployment Failure	3.0 %	pDeployFail	Sat DB
Chance Of Deployment Success	97.0 %	pDeployOK	Sat DB

Table 8.5: Expected Value Probabilities - Deploy

8.1.5 Docking Outcomes

Until servicers are in regular use, a value for the probability of successfully docking a servicer to a target must be estimated. ETS-VII [38] successfully demonstrated robotic docking and Orbital Express [37] will do so again in the near future. The Progress modules that resupplied Mir [103] were docked using an automatic system (Kurs) with human supervision. Apollo and Soyuz modules have also performed many human-in-the-loop dockings. While there have been difficulties, there have been few outright failures. An eventual robotic docking failure rate under 1% seems within the realm of reason, but it is not clear how to refine that number at this point. Table 8.6 shows the values and Equation 8.4 shows how $pDockOK$ is found. A sensitivity analysis of this parameter is included in subsequent analysis, such as Figures 8.3 and 8.4.

$$pDockOK = 1 - pDockFail \quad (8.4)$$

	Percent	Parameter	Basis
Chance Of Docking Failure	1.0 %	pDockFail	Estimate
Chance Of Successful Docking	99.0 %	pDockOK	Estimate

Table 8.6: Expected Value Probabilities - Docking

8.1.6 Undocking Outcomes

After docking with a target satellite and performing a servicing task, the servicer must then undock from the target and move on to its next task. Failure to undock

would likely lead to the loss of both the target satellite and the servicer. James Oberg’s landing safety report [79] on Soyuz shows an occurrence of serious undocking anomalies at a rate of about 1%. He notes that the failures that did occur happened early in the history of undockings and that the failure rate dropped off with time. Table 8.7 shows the rates used in this analysis. It is likely that *pUndockFail* would be even lower in practice.

A 1% chance of undocking failure will be used in this analysis, but in practice, a built-in separation plane could be incorporated into the docking mechanism to guarantee (approaching 0% chance of failure) vehicle separation. Use of the separation plane would leave some portion of the docking mechanism still locked onto the target and the servicer unable to perform any docking operations until repaired. This would leave the target satellite functional as opposed to locked to the servicer and probably unable to fully perform its mission.

	Percent	Parameter	Basis
Chance Of Undocking Failure	1.0 %	pUndockFail	Estimate
Chance Of Successful Undocking	99.0 %	pUndockOK	Estimate

Table 8.7: Expected Value Probabilities - Undocking

8.1.7 Refueling Outcomes

From the Satellite Information Database, it can be seen that over the last 25 years the uncrewed Russian Progress modules have flown over 100 flights. On these flights the Progress modules performed automated on-orbit refueling for various space stations including Salyut-6, Salyut-7, Mir, and ISS. There are no reported failures to accomplish refueling. Astronauts on STS-41G [46] were able to demonstrate accessing a Landsat type fuel port on-orbit using the Orbital Refueling System. These Landsat ground fuel ports are not designed for on-orbit access and require a number of specialty tools for the task. Once the connection between the Landsat port and the fuel

reservoir was established, fuel was successfully transferred between the two multiple times. Given that automated fueling has been accomplished on-orbit many times, and given that a EVA crew member in a dexterity-limiting spacesuit has proved the ability to access a fuel port not built for that purpose, it would appear that prospects for robotic refueling are good. While the task is complex, Ranger [54] has demonstrated much of the required dexterous capability. Still, assessing a percent chance of successfully completing a telerobotic refueling task is still a subjective endeavor. The argument may be made that a refueling mission would only be attempted once ground tests and simulations had raised the probability of success to an acceptable level. Based on these considerations, Table 8.8 shows the rates used in this analysis.

	Percent	Parameter	Basis
Chance Of Refueling Failure	5.0 %	pRefuelFail	Estimate
Chance Of Successful Refueling	95.0 %	pRefuelOK	Estimate

Table 8.8: Expected Value Probabilities - Refuel

8.1.8 Dexterous Repair Outcomes

Finding a firm basis for estimating the probabilities associated with the dexterous repair chance nodes (ORU Replacement, General Repair, Deployment Assistance) is problematic. No parallels emerge readily from the Satellite Information Database. Based on experience with Ranger [54] increasing robotic capability tends to drive up the probability of successfully completing dexterous tasks. The uniqueness and complexity of the General Repair task and the Deployment Assistance task tend to drive their probabilities of success down. The Deployment Assistance opportunities are also very specialized. A servicer would need to be able to dock with the target and then be able to react loads through both the stuck appendage and the satellite body. Table 8.9 shows the rates used in this analysis. Capture probabilities are included as well.

	Percent	Parameter	Basis
Chance ORU Replacement Fails	5.0 %	pORUfail	Estimate
Chance ORU Replacement Succeeds	95.0 %	pORUok	Estimate
Chance General Repair Fails	5.0 %	pRepairFail	Estimate
Chance General Repair Succeeds	95.0 %	pRepairOK	Estimate
Chance Deployment Assistance Fails	5.0 %	pAssistFail	Estimate
Chance Deploy. Assistance Succeeds	95.0 %	pAssistOK	Estimate
Chance Of Unsuccessful Capture	5.0 %	pCaptureFail	Estimate
Chance Of Successful Capture	95.0 %	pCaptureOK	Estimate

Table 8.9: Expected Value Probabilities - Dexterous Repair

8.2 Servicing Mission Expected Values

The following subsections describe the calculation of the expected value break-even servicing fee for each of the servicing mission types. A summary of these calculations is included in Section 8.3. Note that these calculations are for the maximum break-even servicing fee chargeable to a client satellite operator. In most cases it is assumed that the servicer is operational in its working orbit. Calculations for a sample servicer are shown in Chapter 9 and include additional costs and failure regimes over the whole life of the servicer.

8.2.1 Retirement Maneuver

For this mission, the servicer docks to the target satellite at the end of its life and removes it from GEO. This service allows the target spacecraft to burn reserved relocation and margin fuel for a two to three month lifetime extension. More details on this type of mission are available in Section 7.4.1.3. The Expected Value Diagram for this mission is shown in Figure 8.1.

The chance node probabilities for this expect value calculation are established in Section 8.1. Outcome values include 3 cases. The nominal case is that the target satellite successfully transfers itself from geosynchronous orbit to the graveyard orbit.

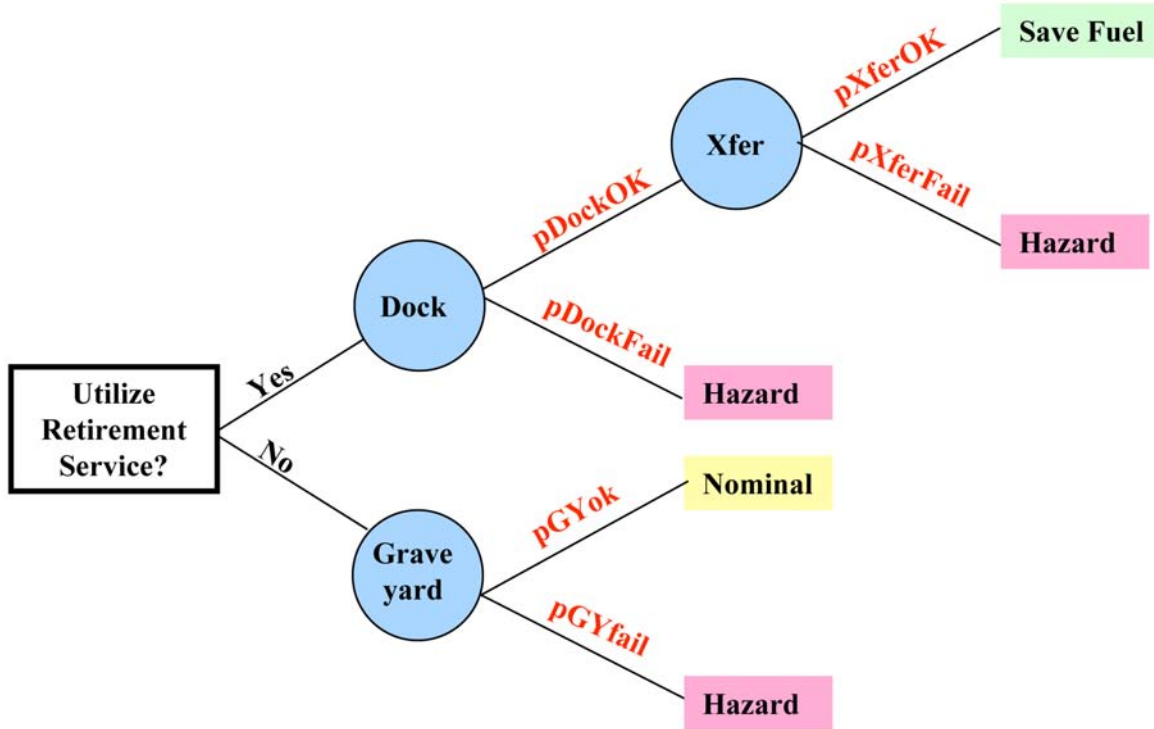

Figure 8.1: Expected Value Diagram For Retirement Mission

Because this is the baseline case, it has a value of zero. The case where the servicer successfully transfers the target satellite to the graveyard orbit provides a revenue benefit (due to extended revenue life) to the target satellite operator of \$11.1M, as shown in Appendix B. The third possible outcome is that the satellite remains as a hazard near geosynchronous orbit. While a set penalty for this has not been established, the FCC has threatened to suspend an operator’s license. For a typical geosynchronous communications satellite, the annual income is \$44.4M (Appendix B). Then again, collision with an active satellite insured for \$200M would be an even larger concern. A one year license suspension with a penalty of \$44.4M (one year of operational revenue) is assumed for this analysis. The Expected Value Diagram for this mission populated with outcome probabilities and values is shown in Figure 8.2.

The expected value equation for not using servicing is shown in Equation 8.5. Here that represents standard retirement procedure, which is to reserve two to three

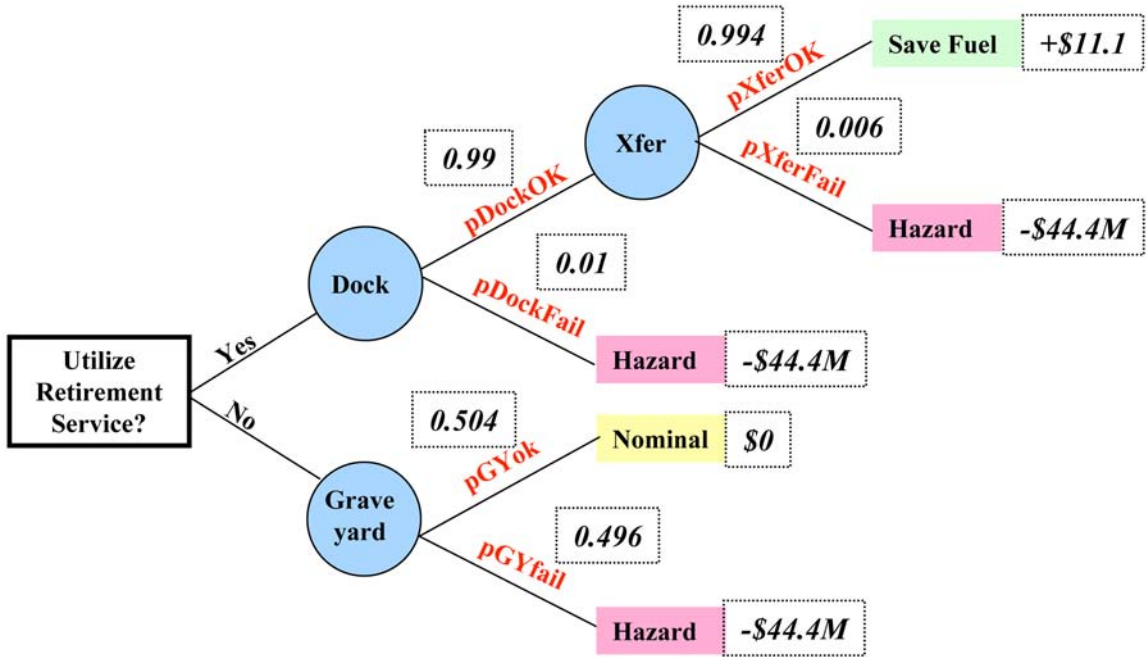

Figure 8.2: Expected Value Diagram For Retirement Mission

months worth of operating fuel for the retirement maneuver. Because this is the baseline case, $vNominal = 0$ and the equation simplifies to Equation 8.6.

$$EV_{Nom} = (pGYok \times vNominal) + (pGYfail \times vHazard) \quad (8.5)$$

$$EV_{Nom} = pGYfail \times vHazard \quad (8.6)$$

The servicing equation, Equation 8.8, is more complex. The servicer must successfully dock with the target and then transfer it to the retirement orbit. It is important to note that the servicing fee, $vSvcFee$, represents a cost to the satellite operator and is therefore a negative number.

$$\begin{aligned}
EV_{Svc} = & (pDockOK \times ((pXferOK \times vSaveFuel) + \\
& (pXferFail \times vHazard))) + \\
& (pDockFail \times vHazard) + vSvcFee
\end{aligned} \tag{8.7}$$

In the break-even case, the two expected values are set equal to each other as shown in Equation 8.8. This can be recast in terms of the fee in Equation 8.10, and simplified into Equation 8.11. Inserting the values from Table 8.10 as shown in Equations 8.12 and 8.12, the break-even servicing fee is \$32.2M. This implies that a servicing company could charge up to \$32.2M to provide a relocation service, and the net value to the operator of the target satellite would be zero. A lower fee would clearly be more attractive to the target satellite operator.

$$EV_{Svc} = EV_{Nom} \tag{8.8}$$

$$\begin{aligned}
vSvcFee = & (pGYfail \times vHazard) - \\
& (pDockOK \times ((pXferOK \times vSaveFuel) + \\
& (pXferFail \times vHazard))) - \\
& (pDockFail \times vHazard)
\end{aligned} \tag{8.9}$$

$$\begin{aligned}
vSvcFee = & vHazard(pGYfail - pDockFail - \\
& (pDockOK \times pXferFail)) - \\
& vSaveFuel(pDockOK \times pXferOK)
\end{aligned} \tag{8.10}$$

$$vSvcFee = vHazard(0.496 - 0.01 - (0.99 \times 0.006)) - vSaveFuel(0.99 \times 0.994) \quad (8.11)$$

$$vSvcFee = -\$44.4M(0.48) - \$11.1M(0.98) \quad (8.12)$$

Parameter	Value	Description
EV_{Nom}		Expected value of not using the retirement service
EV_{Svc}		Expected value of using the retirement service
$pDockOK$	0.99	Probability of successful docking
$pDockFail$	0.01	Probability of unsuccessful docking
$pGYok$	0.504	Probability of successful self transfer to graveyard orbit
$pGYfail$	0.496	Probability of unsuccessful self transfer to graveyard orbit
$pXferOK$	0.994	Probability of successful orbital transfer
$pXferFail$	0.006	Probability of unsuccessful orbital transfer
$vHazard$	-\$44.4M	Value of satellite remaining near GEO as a hazard
$vNominal$	\$0	Value of satellite successfully transiting to the graveyard orbit
$vSaveFuel$	\$11.1M	Value of additional 3 months of operations enabled by saved fuel
$vSvcFee$		Break-even value of servicing fee

Table 8.10: Retirement Maneuver Expected Value Parameters

To explore the sensitivity of this assessment to the estimated probability of docking success, the value of $pDockFail$ can be varied to check the effect. Figure 8.3 shows $vSvcFee$ as a function of $pDockFail$. The feasible value of $vSvcFee$ varies from \$32.7M if there is no chance of failure up to the cross over point at 73.6% where $vSvcFee$ becomes zero. This illustrates that there is a large feasible span of $pDockFail$. While the first attempts at such docking will be challenging, learning effects should decrease the chance of failure over time. For the purposes of this analysis, $pDockFail$ will be set to 1%.

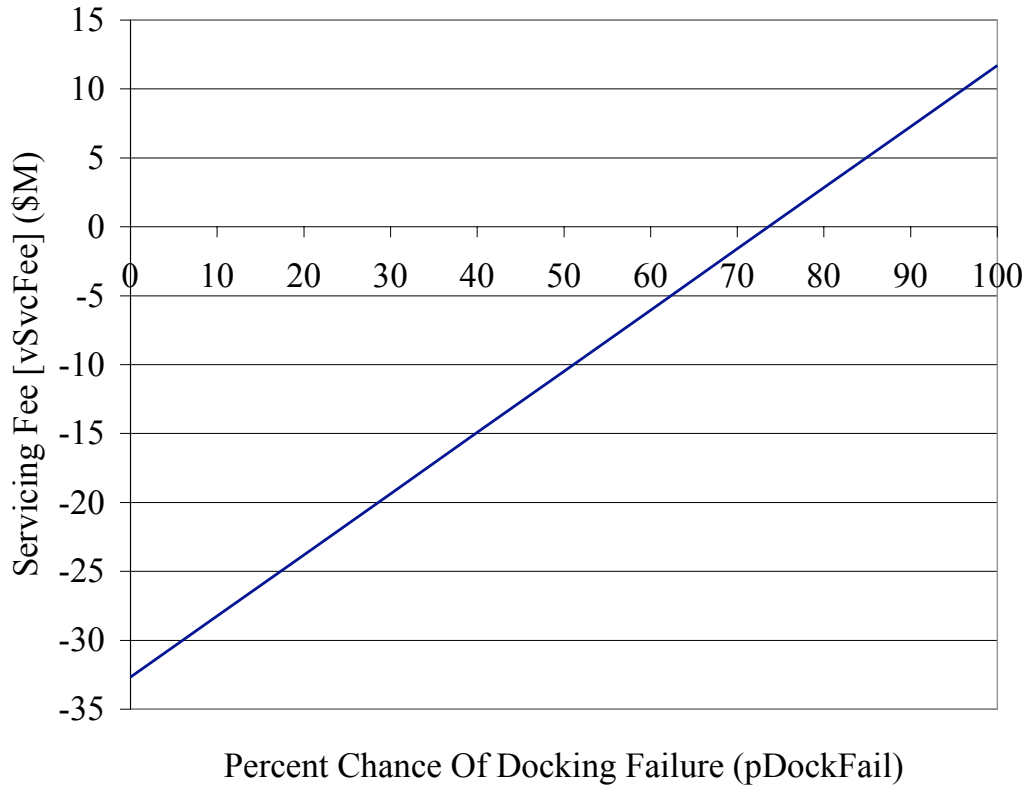

Figure 8.3: $vSvcFee$ Sensitivity To Changes In $pDockFail$

If there were no major penalty for leaving a spacecraft in GEO, but operators still wanted to keep the orbit clear, the above equations can be re-evaluated with $vHazard = 0$. In this case Equation 8.11 can be reduced to Equation 8.13. Substituting in the other values in from Table 8.10, this reduces to Equation 8.14 and then Equation 8.15. The break-even servicing fee for this case is \$10.9M per satellite retired. To be conservative (not account for hazard penalty), this value will be used versus the \$32.2M found earlier. Also note that this calculation is for the n^{th} retirement mission. The first mission must account for the chance of the servicer experiencing a launch anomaly. An example of this accounting is shown in Section 8.2.2. Additionally, there is a chance that the servicer could fail to make the tran-

sition to this target from its previous location. These inter-mission failures must be accounted for when assessing proposed servicers. Chapter 9 includes such accounting.

$$vSvcFee = -vSaveFuel(pDockOK \times pXferOK) \quad (8.13)$$

$$vSvcFee = -\$11.1M(0.99 \times 0.994) \quad (8.14)$$

$$vSvcFee = -\$10.9 \quad (8.15)$$

Figure 8.4 shows the sensitivity of this case to $pDockFail$. Here it can be seen that, because there is no hazard penalty, there is no cross over point. $vSvcFee$ is feasible over the entire span of $pDockFail$.

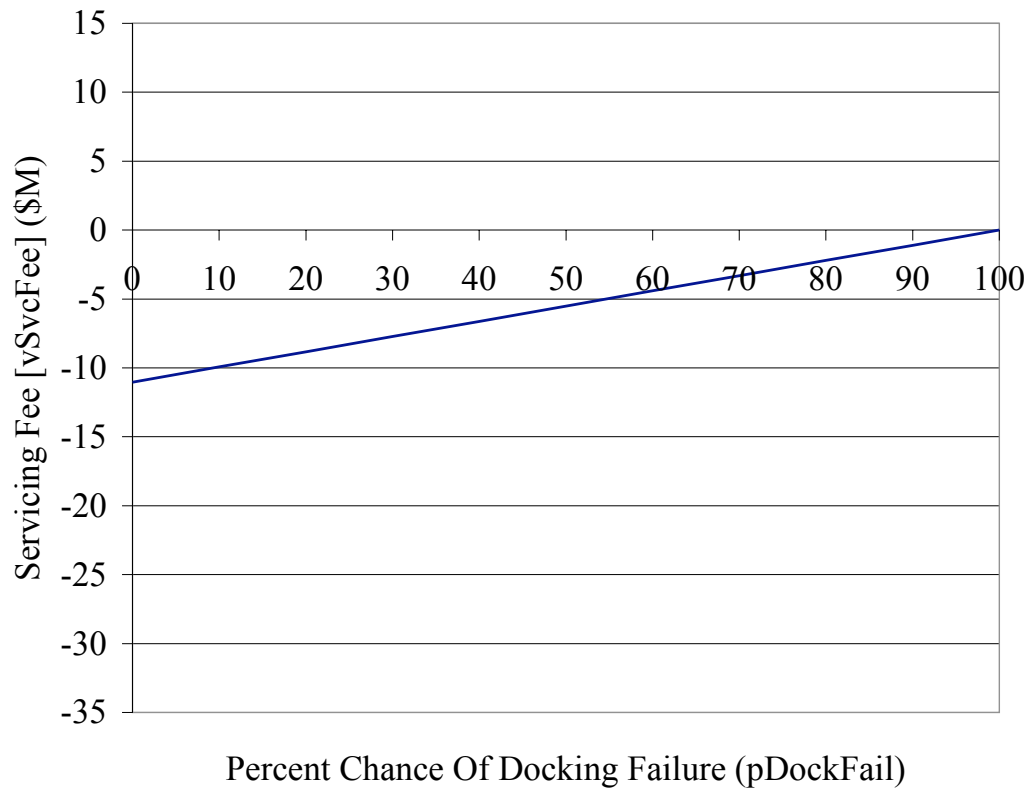

Figure 8.4: *vSvcFee* Sensitivity To Changes In *pDockFail* (No Hazard Penalty)

8.2.2 LEO to GEO Transfer

In this scenario, a spacecraft intended for geosynchronous orbit is stranded in LEO or GTO by the under performance of its launch vehicle or launch vehicle's upper stage. See Section 7.3.1.1 for examples. In some cases, spacecraft have enough onboard fuel to achieve GEO albeit with a significantly reduced fuel lifetime. Those with insufficient fuel to reach working orbit are abandoned in place or commanded to re-enter the atmosphere for disposal. This servicing mission must include a large propulsion package to make up the velocity increment required to achieve geosynchronous orbit. While many other mission opportunities could be performed multiple times per year per servicer, each of these missions is unique and occurs at a rate of about once per year.

The expected value diagram for this mission is shown in Figure 8.5. The top level expected value equations are shown in Equation 8.16 and 8.18. $vWrongOrbit$ represents the value of the satellite in wrong orbit. It will be taken as zero here. $vLoss$ is the value of the satellite if the servicer fails to undock. This will also be taken as zero. Making these substitutions and setting the two expected value equations equal to each other, the servicing fee can be solved for as shown in Equation 8.19. Inserting the values from Table 8.11 results in Equation 8.19 which reduces to Equation 8.20. $vFullMsn$, the value of life of the target satellite, can have different interpretations. It can be the sunk costs to date (manufacturing, launch, insurance, etc.), the insured amount of the spacecraft (typically \$150M), or the revenue stream the satellite represents (up to 12 years of \$44M per year). For the purposes of this analysis the more conservative \$150M will be used for $vFullMsn$, therefore, the final value of Equation 8.20 is \$131M.

$$EV_{Nom} = vWrongOrbit \quad (8.16)$$

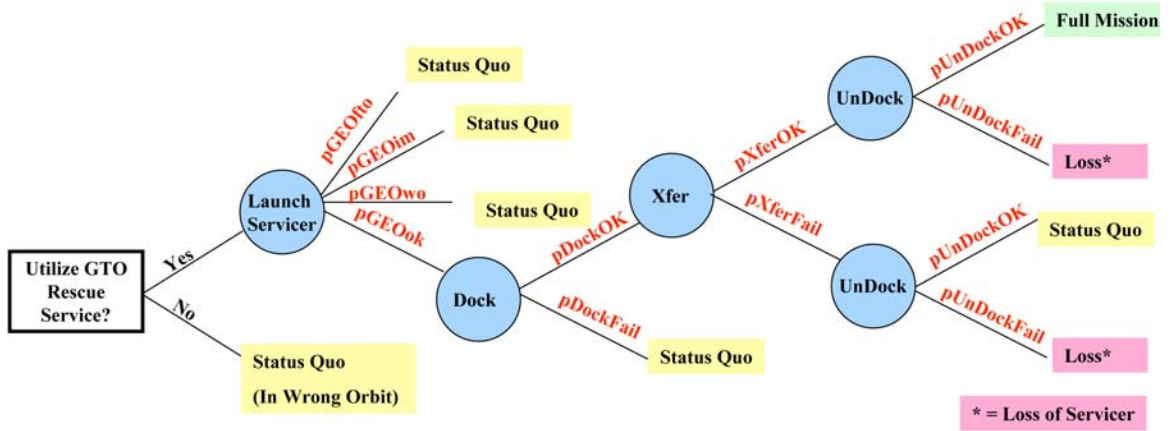

Figure 8.5: Expected Value Diagram For GTO Relocation Mission

$$\begin{aligned}
 EV_{Svc} = & vWrongOrbit(pGEOfto + pGEOwo + pGEOim) + \quad (8.17) \\
 & pGEOok(pDockOK(pXferOK(pUnDockOK(vFullMsn) + \\
 & pUnDockFail(vLoss)) + \\
 & pXferFail(pUnDockOK(vWrongOrbit) + \\
 & pUnDockFail(vLoss))) + pDockFail(vWrongOrbit)) + \\
 & vSvcFee
 \end{aligned}$$

$$\begin{aligned}
 vSvcFee = & -(pGEOok \times pDockOK \times \quad (8.18) \\
 & pXferOK \times pUnDockOK \times vFullMsn)
 \end{aligned}$$

$$vSvcFee = -(0.898 \times 0.99 \times 0.994 \times 0.99 \times vFullMsn) \quad (8.19)$$

$$vSvcFee = -0.875vFullMsn \quad (8.20)$$

Parameter	Value	Description
EV_{Nom}		Expected value of not using the GTO relocation service
EV_{Svc}		Expected value of using the GTO relocation service
$pDockOK$	0.99	Probability of successful docking
$pDockFail$	0.01	Probability of unsuccessful docking
$pGEOfto$	0.048	Probability launch failing to orbit
$pGEOwo$	0.031	Probability of satellite entering wrong orbit initially
$pGEOim$	0.024	Probability of early satellite failure
$pGEOok$	0.898	Probability of successful launch and operations
$pUnDockOK$	0.99	Probability of successful undocking
$pUnDockFail$	0.01	Probability of unsuccessful undocking
$pXferOK$	0.994	Probability of successful orbital transfer
$pXferFail$	0.006	Probability of unsuccessful orbital transfer
$vFullMsn$		Value of satellite after transiting to working orbit
$vLoss$		Value of satellite if servicer fails to undock
$vWrongOrbit$		Value of satellite in wrong orbit
$vSvcFee$		Break-even value of servicing fee

Table 8.11: GTO Relocation Maneuver Expected Value Parameters

To check the sensitivity of these results to the estimated docking and undocking failure rates, the equations were re-evaluated as shown in Table 8.12. Finding 1% or less perturbations from 50% changes in the rate, it appears that these estimates do not have undue influence on the results.

The analysis so far was to answer the question of what the break-even servicer fee would be to rescue a geosynchronous satellite stranded in a low orbit. The servicing option can also be compared directly to replacing the satellite. In this case, the expected value for the replacement case is shown in Equation 8.22. $vSatLoss$ is the value of the replacement mission if the launch or satellite fails. This value is zero. $vReplace$ is the costs for the launch of the new spacecraft (manufacturing, launch, etc.). Setting Equation 8.22 equal to the servicing option, Equation 8.19, and solving for the servicing break-even fee, Equation 8.23 results. Substituting the values from Table 8.11, Equation 8.23 then reduces to Equation 8.24. This implies that the servicing break-even fee can be as high as the cost of the replacement mission minus

	Parameter	Value	Change	Percent Change
Basic $vSvcFee$ Coefficient		0.875		
Effect Of Doubling Docking Chance Failure	$pDockFail$	0.866	-0.009	1.0%
Effect Of Halving Docking Chance Failure	$pDockFail$	0.879	0.004	0.5%
Effect Of Doubling Unocking Chance Failure	$pUnDockFail$	0.866	-0.009	1.0%
Effect Of Halving UnDocking Chance Failure	$pUnDockFail$	0.879	0.004	0.5%

Table 8.12: Docking And Undocking Parameter Sensitivity

2.3% of the value of the full mission. Setting $vReplace$ and $vFullMsn$ to \$150M, the break-even servicing fee becomes \$146M.

$$EV_{Replace} = vSatLoss(pGEOfto + pGEOwo + pGEOim) + pGEOok(vFullMsn) + vReplace \quad (8.21)$$

$$vSvcFee = vReplace + (pGEOok \times vFullMsn) \times (1 - pDockOK \times pXferOK \times pUnDockOK) \quad (8.22)$$

$$vSvcFee = vReplace + (0.898 \times vFullMsn)(1 - (0.99 \times 0.994 \times 0.99)) \quad (8.23)$$

$$vSvcFee = vReplace + (0.023 \times vFullMsn) \quad (8.24)$$

8.2.3 Relocate In GEO

During the life of a geosynchronous satellite, its operator may decide to change the longitude over which it is stationed. To accomplish this, the satellite performs a pair of maneuvers. The first burn alters the orbit from near circular to a slightly more elliptical shape with a period different than earth synchronous. Because of this difference of orbital periods, the satellite can walk its apsis along the geostationary orbit. Once in the correct new location, the satellite performs a second burn of equal magnitude to the first burn and re-circularizes its orbit. The amount of fuel burned to accomplish this relocation is directly tradeable against time in transit. In other words, a bigger burn results in a quicker transition from one location to another. During the transition time, the satellite typically cannot perform its nominal revenue or other tasks. It is also important to note that fuel burned during relocation is no longer available for spacecraft lifetime. A relocation service allows a fast transition and allows the client spacecraft to preserve its lifetime fuel. Earth and moon gravitational affects determine the satellite's drift rate in GEO [39] and can also be used to assist in some long duration relocation maneuvers.

In this scenario the servicer docks to the target, performs the relocation maneuvers, and then undocks from the target and moves on. The expected value diagram is shown in Figure 8.6. The expected value for the nominal case is shown in Equation 8.25 and the servicing case is shown in Equation 8.27. Because no value is gained or lost the nominal mission, $vNominal$, has a value of zero. In the case that the servicer cannot undock from the target, both vehicles would be lost ($vLoss$). The ideal outcome would be the successful relocation which would result in the target satellite saving the relocation fuel and extending its lifetime ($vSaveFuel$). Substituting a zero value for $vNominal$ and setting the two expected value equations equal to each other, the break-even servicing fee ($vSvcFee$) is shown in Equation 8.27. Substituting the values from Table 8.13 into that yields Equation 8.29 which reduces to Equation 8.29.

Substituting \$4.6M for $vSaveFuel$ and -\$150M for $vLoss$, this equation reduces to an expected value break-even value of \$3.0M per relocation.

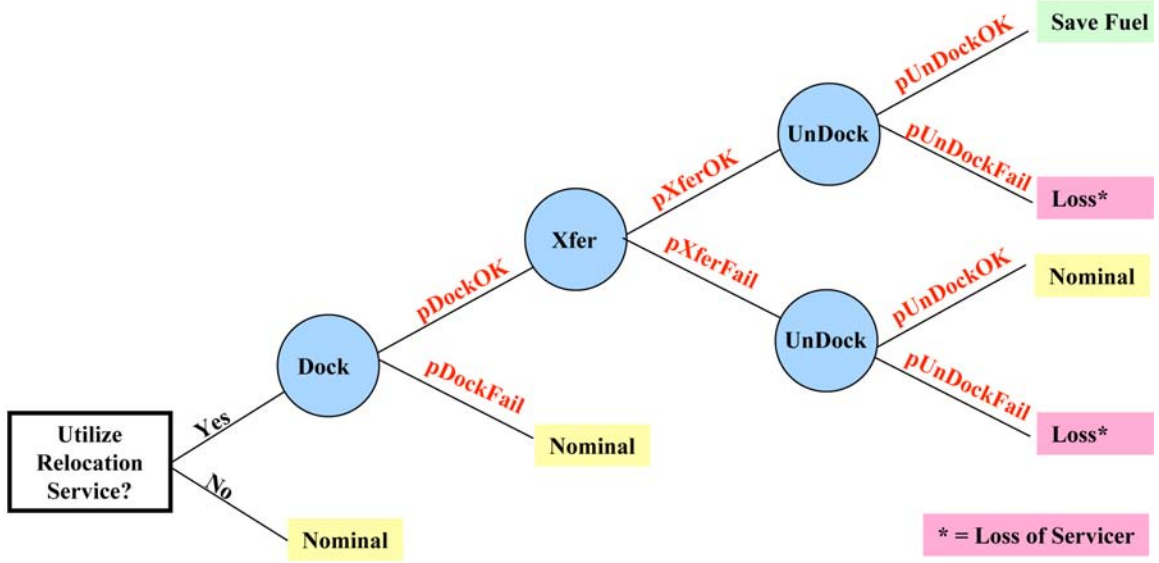

Figure 8.6: Expected Value Diagram For Relocation Mission

$$EV_{Nom} = vNominal \quad (8.25)$$

$$EV_{Svc} = pDockOK(pXferOK(pUnDockOK(VSaveFuel) + pUnDockFail(vLoss)) + pXferFail(pUnDockOK(vNominal) + pUnDockFail(vLoss))) + pDockFail(vNominal) + vSvcFee \quad (8.26)$$

$$vSvcFee = -vSaveFuel(pDockOK \times pXferOK \times pUnDockOK) - vLoss \times pDockOK(pXferOK \times pUnDockFail) + (pXferFail \times pUnDockFail) \quad (8.27)$$

$$vSucFee = -vSaveFuel(0.99 \times 0.994 \times 0.99) - vLoss \times 0.99(0.994 \times 0.01) + (0.006 \times 0.01) \quad (8.28)$$

$$vSucFee = -vSaveFuel(0.974) - vLoss(0.010) \quad (8.29)$$

Parameter	Value	Description
EV_{Nom}		Expected value of not using the GEO relocation service
EV_{Svc}		Expected value of using the GEO relocation service
$pDockOK$	0.99	Probability of successful docking
$pDockFail$	0.01	Probability of unsuccessful docking
$pUnDockOK$	0.99	Probability of successful docking
$pUnDockFail$	0.01	Probability of unsuccessful docking
$pXferOK$	0.994	Probability of successful orbital transfer
$pXferFail$	0.006	Probability of unsuccessful orbital transfer
$vSaveFuel$		Value of fuel savings
$vLoss$		Value of satellite if servicer fails to undock
$vNominal$		Value of target performing GEO relocation itself
$vSucFee$		Break-even value of servicing fee

Table 8.13: Relocation In GEO Expected Value Parameters

8.2.4 Refuel

In this scenario the servicer docks with the target satellite and the servicer accesses the target's fuel port to enable a propellant transfer. The expected value diagram is shown in Figure 8.7. The expected value for the nominal case is shown in Equation 8.30 and the servicing case is shown in Equation 8.32. Because no value is gained or lost the nominal mission, $vNominal$, has a value of zero. In the case that the servicer cannot undock from the target, both vehicles would be lost ($vLoss$). The ideal outcome would be the successful refueling enabling the target satellite to extend its life ($vRefueled$). Substituting a zero value for $vNominal$ and setting the two expected value equations equal to each other, the break-even servicing fee ($vSvcFee$) is shown in Equation 8.32. Substituting the values from Table 8.14 into that yields Equation 8.34 which reduces to Equation 8.34. A servicer could refuel the target all the way up to its full capacity. The trade study for how much fuel to deliver per mission is a separate analysis. Assigning $vRefueled$ to be \$44.4M (one year of revenue) and $vLoss$ to be \$150M, yields a $vSvcFee$ of about \$40M.

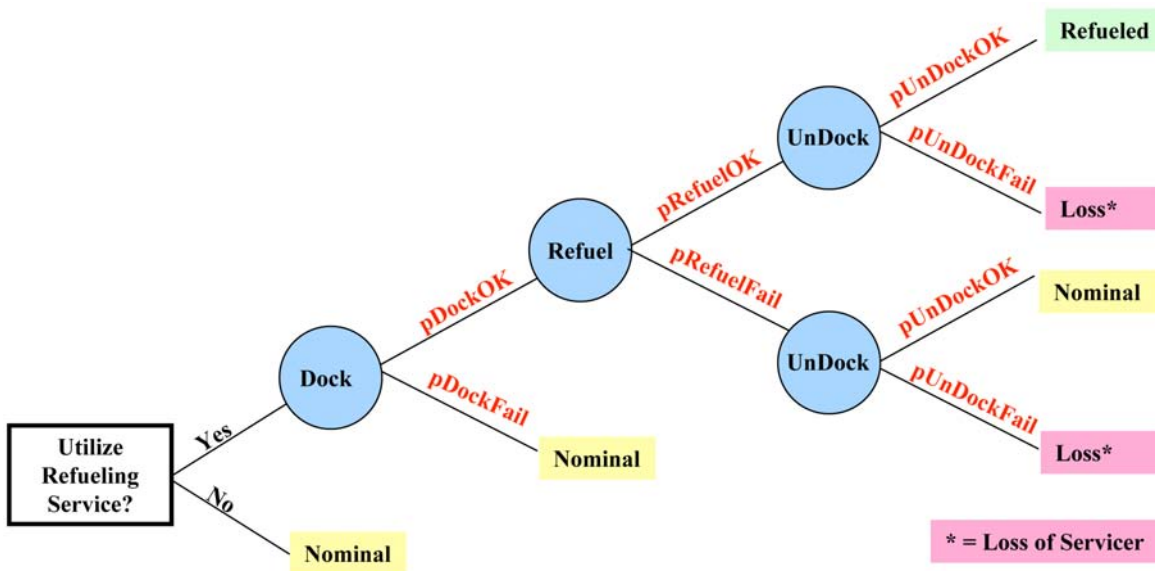

Figure 8.7: Expected Value Diagram For Refueling Mission

$$EV_{Nom} = vNominal \quad (8.30)$$

$$EV_{Svc} = pDockOK(pRefuelOK(pUnDockOK(vRefueled) + \quad (8.31)$$

$$pUnDockFail(vLoss)) + pRefuelFail(pUnDockOK(vNominal) +$$

$$pUnDockFail(vLoss))) + pDockFail(vNominal) + vSvcFee$$

$$vSvcFee = -vRefueled(pDockOK \times pRefuelOK \times pUnDockOK) -$$

$$vLoss \times pDockOK(pRefuelOK \times pUnDockFail) +$$

$$(pRefuelFail \times pUnDockFail) \quad (8.32)$$

$$vSvcFee = -vRefueled(0.99 \times 0.95 \times 0.99) - \quad (8.33)$$

$$vLoss \times 0.99(0.95 \times 0.01) + (0.05 \times 0.01))$$

$$vSvcFee = -vRefueled(0.931) - vLoss(0.010) \quad (8.34)$$

Parameter	Value	Description
EV_{Nom}		Expected value of not using the refueling service
EV_{Svc}		Expected value of using the refueling service
$pDockOK$	0.99	Probability of successful docking
$pDockFail$	0.01	Probability of unsuccessful docking
$pUndockOK$	0.99	Probability of successful docking
$pUndockFail$	0.01	Probability of unsuccessful docking
$pRefuelOK$	0.95	Probability of successful refueling
$pRefuelFail$	0.05	Probability of unsuccessful refueling
$vRefueled$		Value of fuel savings
$vLoss$		Value of satellite if servicer fails to undock
$vNominal$		Value of nominal satellite operations
$vSvcFee$		Break-even value of servicing fee

Table 8.14: Refueling Expected Value Parameters

8.2.5 ORU-Like Replacement

In this scenario a replacement ORU is launched and the servicer docks first with ORU carrier. It retrieves the ORU, undocks, rendezvous and docks with the target satellite, performs the ORU replacement, and then undocks. The expected value diagram is shown in Figure 8.8. The expected value for the nominal case is shown in Equation 8.35 and the servicing case is shown in Equation 8.37. Because no value is gained or lost the nominal mission, $vNominal$, has a value of zero. Setting the two equations equal to each other, inserting the values from Table 8.15, and solving for the servicing fee results in Equations 8.37 through 8.39.

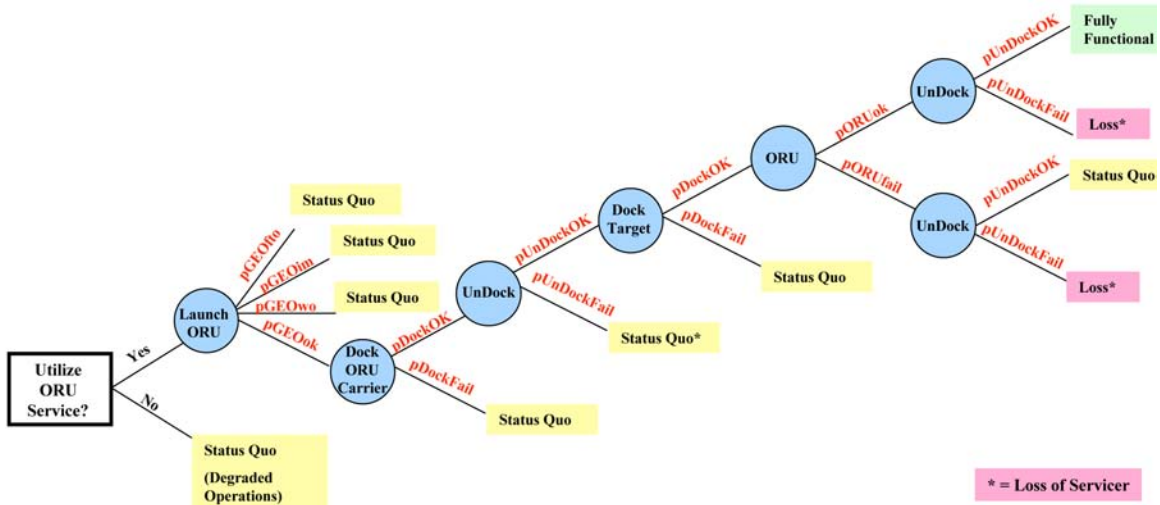

Figure 8.8: Expected Value Diagram For ORU-Like Replacement Mission

$$EV_{Nom} = vNominal \quad (8.35)$$

$$\begin{aligned}
EV_{Svc} = & (pGEOok \times pDockOK \times pUnDockOK \times pDockOK \times \quad (8.36) \\
& pORUok(pUndockOK(vFullFunc))) + \\
& (pGEOok \times pDockOK \times pUnDockOK \times pDockOK \times \\
& pORUok(pUndockFail(vLoss))) + \\
& (pGEOok \times pDockOK \times pUnDockOK \times pDockOK \times \\
& pORUfail(pUndockFail(vLoss))) + vSvcFee
\end{aligned}$$

$$\begin{aligned}
vSvcFee = & -(pGEOok \times pDockOK \times pUnDockOK \times pDockOK) \times \\
& ((pORUok \times pUndockOK \times vFullFunc) + \\
& (pUndockFail \times vLoss)) \quad (8.37)
\end{aligned}$$

$$\begin{aligned}
vSvcFee = & -(0.898 \times 0.99 \times 0.99 \times 0.99) \times \quad (8.38) \\
& ((0.95 \times 0.99 \times \$100M) + (0.01 \times -\$100M))
\end{aligned}$$

$$vSvcFee = -\$81M \quad (8.39)$$

Parameter	Value	Description
EV_{Nom}		Expected value of not using the service
EV_{Svc}		Expected value of using the service
$pDockOK$	0.99	Probability of successful docking
$pDockFail$	0.01	Probability of unsuccessful docking
$pGEOfto$	0.048	Probability launch failing to orbit
$pGEOwo$	0.031	Probability of satellite entering wrong orbit initially
$pGEOim$	0.024	Probability of early satellite failure
$pGEOok$	0.898	Probability of successful launch and operations
$pORUok$	0.95	Probability of successfully replacing ORU
$pORUfail$	0.05	Probability of unsuccessful ORU replacement
$pUndockOK$	0.99	Probability of successful undocking
$pUndockFail$	0.01	Probability of unsuccessful undocking
$vFullFunc$	\$100M	Value of satellite if repaired
$vLoss$	-\$100M	Value of satellite if servicer fails to undock
$vNominal$	\$0	Value of nominal satellite operations
$vSvcFee$		Break-even value of servicing fee

Table 8.15: ORU-Like Replacement Expected Value Parameters

8.2.6 General Repair

This mission is similar to but more dexterously complex than the ORU case. The expected value diagram is shown in Figure 8.9. Given the similar parameters, the servicing fee is taken to be the same.

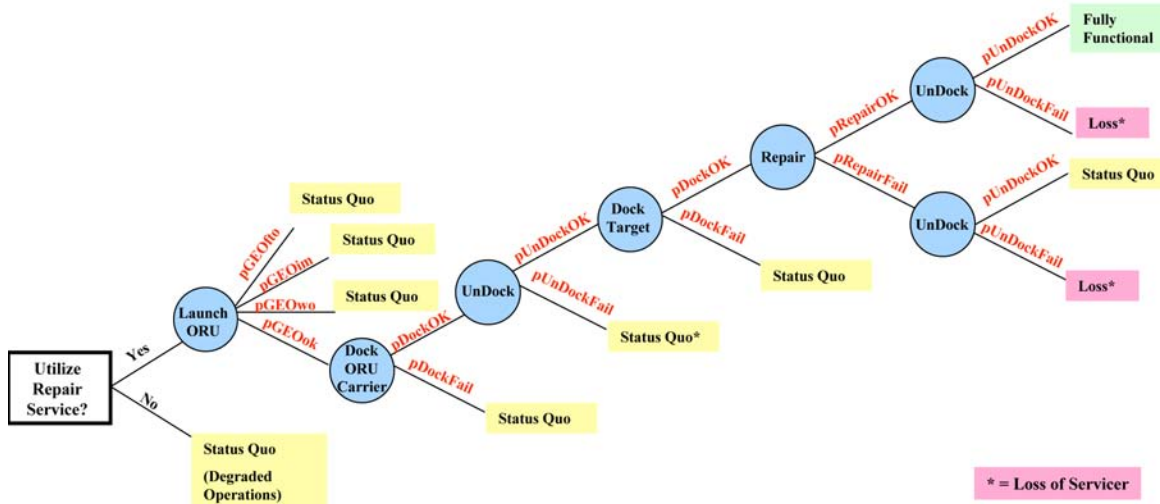

Figure 8.9: Expected Value Diagram For General Repair Mission

8.2.7 Deployment Assistance

This scenario assumes that a dexterous servicer docks with target and uses its manipulators to assist a stuck appendage to deploy. Figure 8.10 shows the expected value diagram. The expected value for the nominal case is shown in Equation 8.40 and the servicing case is shown in Equation 8.41. Because no value is gained or lost the nominal mission, $v_{Nominal}$, has a value of zero. Setting the two equations equal to each other, inserting the values from Table 8.16, and solving for the servicing fee results in Equations 8.42 through 8.44.

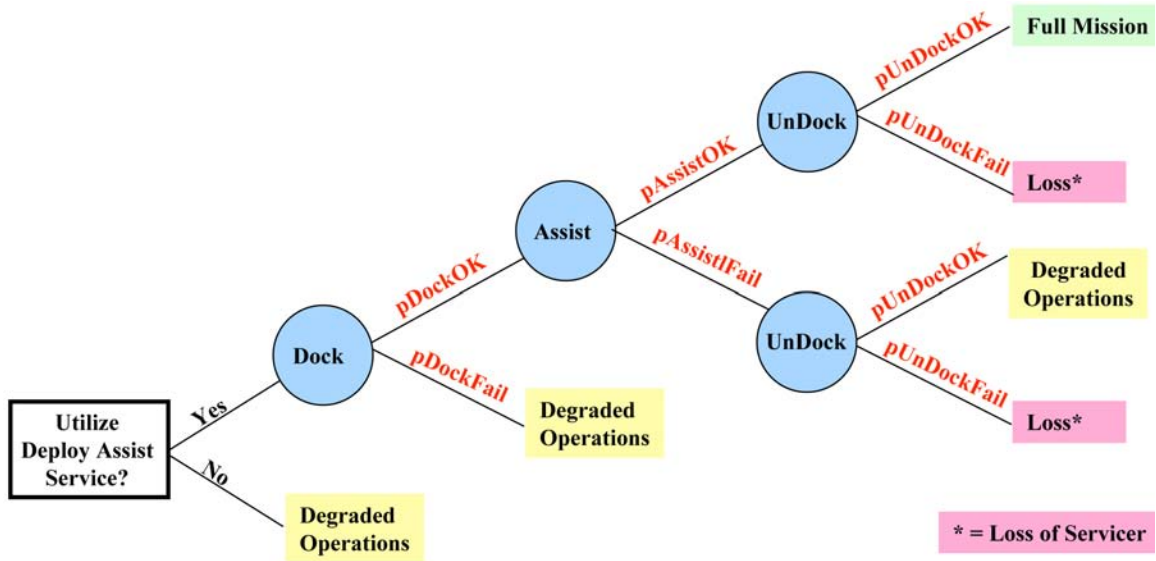

Figure 8.10: Expected Value Diagram For Deployment Assistance Mission

$$EV_{Nom} = v_{Nominal} \quad (8.40)$$

$$\begin{aligned}
EV_{Svc} &= ((pDockOK \times pAssistOK \times pUnDockOK)vFullFunc) + \\
&((pDockOK \times pAssistOK \times pUnDockFail)vLoss) + \\
&((pDockOK \times pAssistFail \times pUnDockFail)vLoss) + \\
&vSvcFee
\end{aligned} \tag{8.41}$$

$$\begin{aligned}
vSvcFee &= -((pDockOK \times pAssistOK \times pUnDockOK)vFullFunc) + \\
&((pDockOK \times pAssistOK \times pUnDockFail)vLoss) + \\
&((pDockOK \times pAssistFail \times pUnDockFail)vLoss)
\end{aligned} \tag{8.42}$$

$$\begin{aligned}
vSvcFee &= -((0.99 \times 0.95 \times 0.99)\$91M) + \\
&((0.99 \times 0.95 \times 0.01) - \$91M) + \\
&((0.99 \times 0.05 \times 0.01) - \$91M)
\end{aligned} \tag{8.43}$$

$$vSvcFee = -\$81M \tag{8.44}$$

Parameter	Value	Description
EV_{Nom}		Expected value of not using the service
EV_{Svc}		Expected value of using the service
$pDockOK$	0.99	Probability of successful docking
$pDockFail$	0.01	Probability of unsuccessful docking
$pAssistOK$	0.95	Probability of successfully assisting deployment
$pAssistFail$	0.05	Probability of unsuccessful deployment assistance
$pUnDockOK$	0.99	Probability of successful undocking
$pUnDockFail$	0.01	Probability of unsuccessful undocking
$vFullFunc$	\$91M	Value of satellite if repaired
$vLoss$	-\$91M	Value of satellite if servicer fails to undock
$vNominal$	\$0	Value of nominal satellite operations
$vSvcFee$		Break-even value of servicing fee

Table 8.16: Deployment Assistance Expected Value Parameters

8.2.8 Deployment Monitoring

In this case the servicer provides video downlink of the deployment operations of the target spacecraft, including solar and antenna deployment. This service gives ground controllers additional information to resolve deployment anomalies. Given the small number of total failures resulting from deployment anomalies, this is unlikely to be a service driving servicer development. However, once such a capability was available, it seems likely that it would be attractive. For instance, on Galaxay 11 [19], a dedicated camera was integrated onto the spacecraft to monitor the deployment of a new solar array type. The mass and cost of the camera was small relative to the satellite, but every kilogram in GEO costs \$40,000 to get there (Appendix F).

The expected value diagram is shown in Figure 8.11. The expected value for the nominal case is shown in Equation 8.45 and the servicing case is shown in Equation 8.47. Because no value is gained or lost in the nominal mission, $vNominal$, has a value of zero. Combining the equations, solving for the servicing fee, and substituting the values from Table 8.17, leads from Equations 8.48 and 8.48 to Equation 8.49. While a value can be found for $vDeployFail$ based on past deployment failure losses, assigning a value to $vProblemDetect$ is difficult. The servicer would have to have the correct view to see the deployment anomaly before damage was done and the ground operators would have to react in time to halt deployment in the face of a communications time delay. Even granting the detection of the anomaly, it is not clear that the controllers could do anything about it. Basically, $vProblemDetect$ can range anywhere from zero to $vDeployFail$. Not having any additional information, $vProblemDetect$ will be set to 50% of $vDeployFail$. This is shown in Equation 8.50, and the final value is shown in Equation 8.51.

$$EV_{Nom} = vNominal(pDeployOK) + vDeployFail(pDeployFail) \quad (8.45)$$

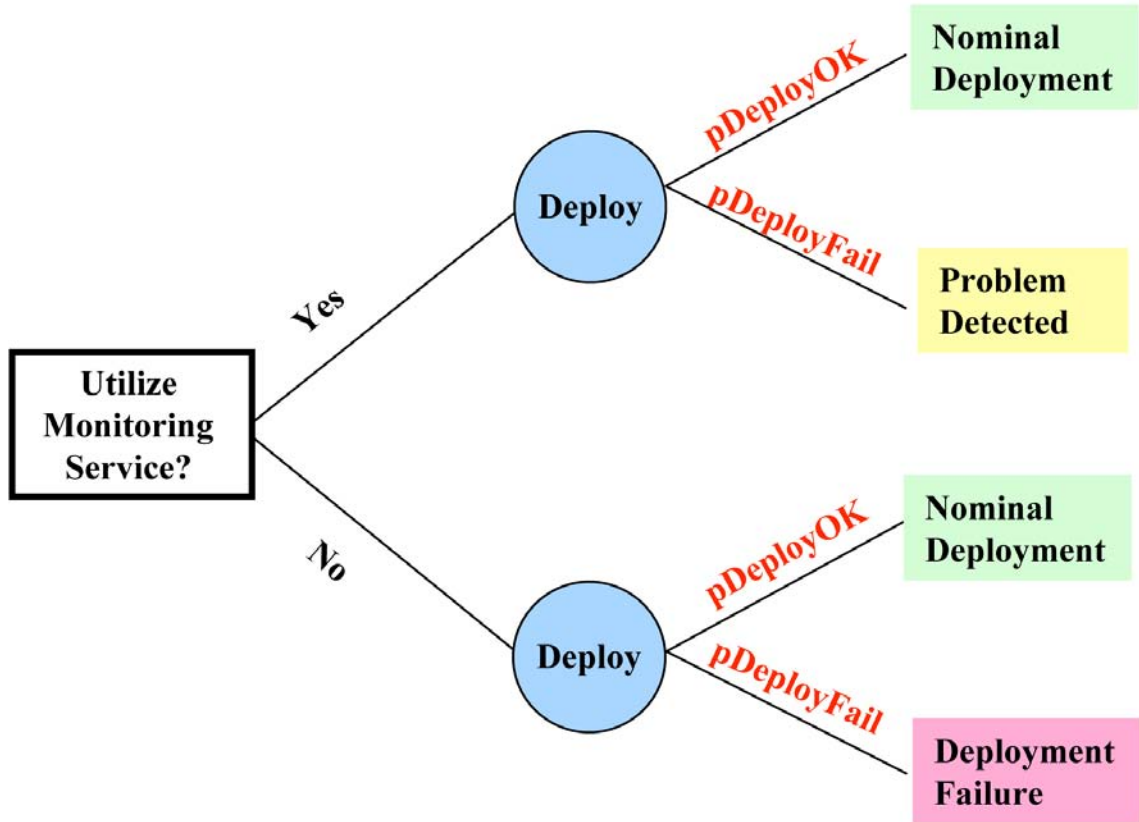

Figure 8.11: Expected Value Diagram For Deployment Monitoring Mission

$$EV_{Svc} = vNominal(pDeployOK) + vProblemDetect(pDeployFail) + vSvcFee \quad (8.46)$$

$$EV_{Svc} = (vNominal(pDeployOK) + vDeployFail(pDeployFail)) - (vNominal(pDeployOK) + vProblemDetect(pDeployFail)) \quad (8.47)$$

$$EV_{Svc} = pDeployFail(vDeployFail - vProblemDetect) \quad (8.48)$$

$$EV_{Svc} = 0.03(vDeployFail - vProblemDetect) \quad (8.49)$$

$$EV_{Svc} = 0.03 \times 0.5 \times -\$91.1M \quad (8.50)$$

$$EV_{Svc} = \$1.4M \quad (8.51)$$

Parameter	Value	Description
EV_{Nom}		Expected value of not using the service
EV_{Svc}		Expected value of using the service
$pDeployOK$	0.97	Probability of successful deployment
$pDeployFail$	0.03	Probability of unsuccessful deployment
$vProblemDetect$		Value of detecting a deployment anomaly
$vDeployFail$	-\$91.1M	Value of deployment failure
$vNominal$	\$0	Value of nominal satellite operations
$vSvcFee$		Break-even value of servicing fee

Table 8.17: Refueling Expected Value Parameters

8.2.9 Remove Inactive

In this case the servicer captures an inactive spacecraft or other orbital debris and removes it from GEO. This is done to reduce the chance of collision with an active spacecraft. The Expected Value diagram for this case is shown in Figure 8.12. As seen in the figure, no revenue source is included. This service is primarily for reducing the chance of negative outcomes. For the purpose of this analysis, it is assumed that the target spacecraft is in violation of the FCC retirement regulation and that v_{Hazard} has a value of $-\$44.4M$.

Equations 8.52 and 8.52 show the nominal and servicing cases. Setting these equations equal to each other and solving for the servicing fee results in Equation 8.55. Simplifying this equation and substituting the parameters from Table 8.18 is shown in Equations 8.56 through 8.57. Solving numerically, the servicing fee is shown in Equation 8.58.

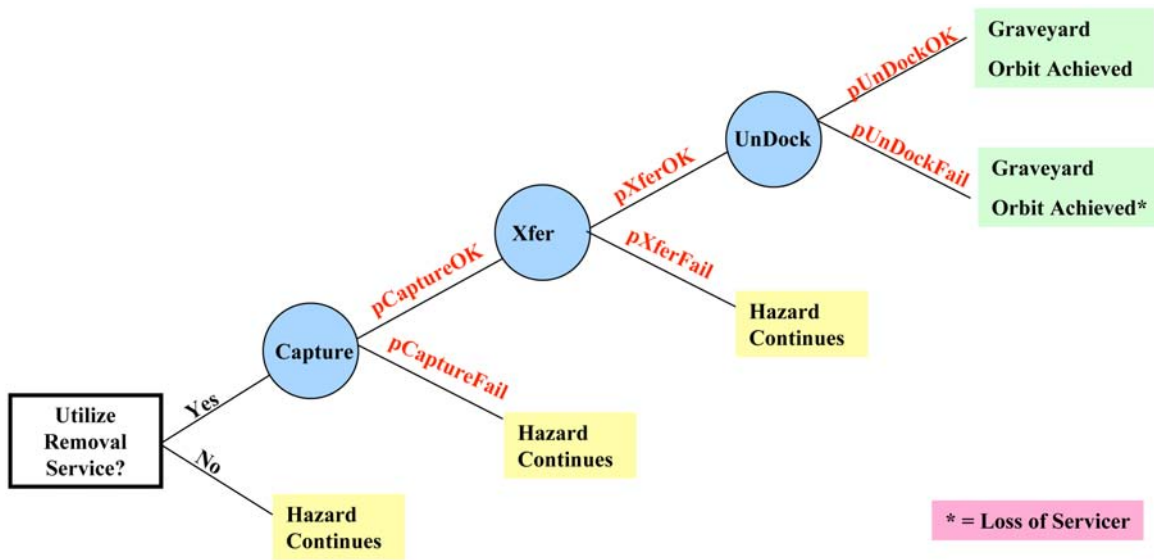

Figure 8.12: Expected Value Diagram For Removal Of Inactive Mission

$$EV_{Nom} = v_{Hazard} \tag{8.52}$$

$$\begin{aligned}
EV_{Svc} &= p_{CaptureFail}(v_{Hazard}) + & (8.53) \\
& p_{CaptureOK}(p_{XferFail}(v_{Hazard}) + \\
& p_{XferOK}(v_{Removed})) + v_{SvcFee}
\end{aligned}$$

$$\begin{aligned}
EV_{Svc} &= v_{Hazard}(p_{CaptureFail} + & (8.54) \\
& (p_{CaptureOK} \times p_{XferFail})) + v_{SvcFee}
\end{aligned}$$

$$\begin{aligned}
v_{SvcFee} &= v_{Hazard} - (v_{Hazard}(p_{CaptureFail} + & (8.55) \\
& (p_{CaptureOK} \times p_{XferFail})))
\end{aligned}$$

$$\begin{aligned}
v_{SvcFee} &= v_{Hazard}(1 - p_{CaptureFail} - & (8.56) \\
& (p_{CaptureOK} \times p_{XferFail}))
\end{aligned}$$

$$v_{SvcFee} = -\$44.4M(1 - 0.05 - (0.95 \times 0.006)) \quad (8.57)$$

$$v_{SvcFee} = -\$41.9M \quad (8.58)$$

Parameter	Value	Description
EV_{Nom}		Expected value of not using the removal service
EV_{Svc}		Expected value of using the removal service
$p_{CaptureOK}$	0.95	Probability of successful capture
$p_{CaptureFail}$	0.05	Probability of unsuccessful capture
$p_{UnDockOK}$	0.99	Probability of successful docking
$p_{UnDockFail}$	0.01	Probability of unsuccessful docking
p_{XferOK}	0.994	Probability of successful orbital transfer
$p_{XferFail}$	0.006	Probability of unsuccessful orbital transfer
v_{Hazard}	-\$44.4M	Value of continuing hazard
$v_{Removed}$	\$0	Value of removing hazard
v_{SvcFee}		Break-even value of servicing fee

Table 8.18: Refueling Expected Value Parameters

8.2.10 Health Monitoring

Health monitoring consists of an external visual survey of a target spacecraft. This inspection could be conducted by a dexterous servicer or even a small, light dedicated camera platform (AERCam [25], SCAMP [34], etc.). Solar array degradation, micrometeor damage, and other effects of the space environment could be monitored. This is a prophylactic service and could be called upon in a number of circumstances. For instance, if a family of spacecraft began to experience similar failures, operators might want to examine their spacecraft of that type. While every active GEO satellite could conceivably be an annual client, there does not appear to be a direct way to show a benefit for health monitoring. Given these considerations, no expected value diagram or servicing fee was developed for this case.

8.3 Summary Of Servicing Mission Expected Values

Table 8.19 summarizes the findings from the previous sections in descending order of average annual market value. For each of the servicing missions, the break-even servicing fee, the annual opportunities per type of service, and the maximum annual market value are listed. Note again that the break-even fee is the maximum fee chargeable for the revenue of the serviced satellite to balance the servicing fee and possible negative outcomes. Having fully populated the table, a number of caveats are required. The market value for the Remove Inactive mission is based on avoiding a penalty for leaving an inactive object near GEO. This penalty is not yet being enforced and could drop this sizable market value to zero. Also, a market value for the Health Monitoring service could not be established.

While this identification of over \$2B worth of annual opportunities should en-

Service	Break-Even Servicing Fee	Average Annual Opportunities	Annual Market Value
Refuel	\$40M	20	\$800M
Remove Inactive	\$41.9M	10.5	\$440M
ORU Replacement	\$81M	4.4	\$356M
General Repair	\$81M	3.8	\$308M
GEO Retirement	\$10.9M	20	\$218M
LEO To GEO Transfer	\$131M	1	\$131M
Relocation In GEO	\$4.6M	13	\$60M
Deployment Monitoring	\$1.4M	20	\$28M
Deployment Assistance	\$84M	0.3	\$25M
Health Monitoring	\$0	200	\$0
Total			\$2,366M

Table 8.19: Expected Value Break-Even Servicing Fees

courage the prospects for a commercial servicing market, a single servicing vehicle is unlikely to be efficient at performing in each of these missions areas. For instance, a servicer providing relocation services is concerned primarily about propulsive efficiency. Transport of additional dexterous arms and equipment needed for other mission types would only decrease the servicer's effectiveness in this regime. The question now becomes which segment to pursue first. This is a complex issue. Simply picking the segment from Table 8.19 with the highest annual market value would lead one towards the Refuel mission. However, other missions with higher payoffs per target serviced are also attractive, such as LEO To GEO Transfer. Another useful criterion to apply is to check for the minimum number of events per service type that has occurred over the ten year period from 1984 to 2003. To be completely conservative, the Remove Inactive and Deployment Monitoring mission values are set to zero as well due to the uncertainty of the expected benefits for those missions.

Table 8.20 shows the result of seeking the floor for the annual value of these market segments. This shows that while the LEO To GEO Transfer service is a big payoff, there have been years where no such failure occurred. This means that a

servicer for this market segment would generate no revenue. Again we find Refuel at the top of the value ranked list. Are there any other considerations for selecting a first mission type? The next section will take a look at the complexity of the robotic tasks required to accomplish the missions.

Service	Break-Even Servicing Fee	Minimum Annual Opportunities	Annual Market Value
Refuel	\$40M	6	\$240M
GEO Retirement	\$10.9M	6	\$65M
Relocation In GEO	\$4.6M	10	\$46M
Deployment Monitoring	\$1.4M	18	\$0
Remove Inactive	\$0	2	\$0
ORU Replacement	\$81M	0	\$0
General Repair	\$81M	0	\$0
LEO To GEO Transfer	\$131M	0	\$0
Deployment Assistance	\$84M	0	\$0
Health Monitoring	\$0	200	\$0
Total			\$351M

Table 8.20: Minimum Annual Servicing Market

8.4 Robotic Complexity

In addition to the primarily economic factors examined so far, this section reviews the robotic complexity of the various servicing missions. Table 8.21 rank orders the missions in terms of increasing robotic task complexity. The “Video” column indicates the need for a video system for inspection, docking, and dexterous operations. Future satellites and servicer designed specifically for servicing could have such complimentary designs so as to obviate the need for video, but such future vehicles are not part of this consideration. The “Dock. Mech.” column refers to a docking mechanism capable of attaching the servicer to the target. For GEO targets, this will likely be accomplished via the launch interface ring on the base of the satellite or the AKM

nozzle. While there is not a standard geometry for all GEO satellites, there are large families of spacecraft with similar configurations. The “Dex. Arms” column shows whether dexterous operations, beyond docking, are required to fulfill the mission requirements. The “Dex. Task Variety” column indicates the variety in the tasks to be performed by the dexterous arms included on the servicer. Finally, the “Robotic Complexity” column is a basic stair-step rating that increments as a new robotic capability is required. While an increment of one is shown between each rank, this is not intended to imply that the robotic complexity (and cost) increases linearly along the scale.

Mission	Video	Dock. Mech.	Dex. Arms	Dex. Task Variety	Robotic Complexity
Deployment Monitoring	x				1
Health Monitoring	x				1
LEO to GEO Transfer	x	x			2
Retirement Maneuver	x	x			2
Relocate In GEO	x	x			2
Refuel	x	x	x	1	3
Remove Inactive	x	x	x	1+	4
ORU-like Replacement	x	x	x	Varied	5
Deployment Assistance	x	x	x	Varied	5
General Repair	x	x	x	Complex	6

Table 8.21: Robotic Complexity By Mission

The simplest missions are the Deployment Monitoring and Health Monitoring missions. These are likely secondary missions and are enabled by the video capability required for any of the other missions. The Deployment Assistance mission opportunity is infrequent and is enabled by the dexterous capability achieved by either the ORU-like Repair, General Repair, or perhaps the Remove Inactive servicer. The task specific arms for the Refuel mission may not lead to an adaptable system for Deployment Assistance. The Refuel servicer will perform a single task with its arms. The Remove Inactive servicer will also be attempting only one type of task,

namely grappling either inactive spacecraft or rocket debris and removing such from an operational orbit. While this is one task type, the grasps required will likely vary significantly, and the arms of this servicer will need more adaptability than those of the Refuel servicer. Both the ORU-like Replacement and the Deployment Assistance servicer will be performing a variety of tasks depending on the configuration of the target. Finally, the General Repair servicer will include the most capable dexterous manipulators in order to perform the most difficult type of repairs. This difficulty rating is assessed both for the systemic nature of these types of failures and because ambiguous and unknown failures are also included in this category.

Ranking the top three contenders from the previous section on this scale yields a tie between Retirement Maneuver and Relocate In GEO as most desirable with Refuel in the next echelon. Both Retirement and Relocation missions consist of rendezvous, docking, and relocation operations. No additional dexterous robotic activity is needed. For Refuel, the servicer must perform rendezvous and docking, as well as, dexterous operations to access the fuel port and to transfer fuel.

How then to break the tie between Retirement and Relocation? Both provide propulsive services and extend the useful lifetime of the target satellite. A final discriminator is the nature of the target. For Relocation, the target satellite can be in any stage of its life. A significant mishap during such a servicing mission could affect the entire lifespan of an active satellite. Conversely, the Retirement missions are by definition intended for satellites nearing the end of their useful lives.

This low risk mission provides an excellent opportunity to demonstrate the technical and economic feasibility of telerobotic on-orbit satellite servicing. The chance of success for this mission is high and the potential downside is low. Success will increase the likelihood of opening and expanding the servicing market to the additional more complex services previously defined. An illustration of the Retirement mission performed by a proposed servicer is further evaluated in the following

chapter. This analysis will reveal a profitable market segment reachable with current technologies.

Chapter 9

Demonstration Of The New Method

Having developed the expected-value break-even servicing fees for various missions in Chapter 8 and having identified GEO Retirement from amongst these as the prime candidate for an initial servicing market segment to be developed, this chapter demonstrates the utility of the new feasibility method in conjunction with a proposed servicing system. In particular, a low mass, Mini-Class Servicer is investigated for its viability to provide retirement services to geosynchronous spacecraft.

9.1 Servicer Description

The Mini-Class Servicer is a 300 kg dexterous servicing vehicle based on the SSL's 100 kg dexterous MODSS servicing robot [40]. An extension of this design modified to utilize a Ariane 5 "Mini" payload slot was explored in [91]. The Mini slots are 1.5m high and 1.5m in diameter [17]. Up to 4 Mini payloads can be accommodated on the Ariane 5 ASAP5 auxiliary payload structure. An image of MODSS is shown in Figure 9.1. While this image shows a multi-armed dexterous servicer, the Mini design has a dedicated docking device in place of the manipulators. An additional modification of the MODSS design was to increase the fuel capacity up to the Mini class launch mass limit. Table 9.1 contains a mass breakout of the Mini-Servicer. Components and masses are based on MODSS. The mass breakout for GasPod, a

fuel delivery vehicle, is shown in Table 9.2. 10% mass margins for both vehicles were maintained due to the preliminary nature of these designs.

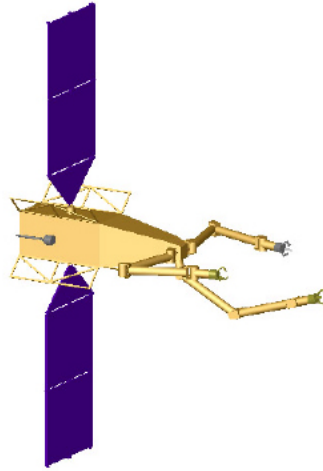

Figure 9.1: MODSS Servicer [40]

Component	Unit Mass (kg)	Qty	Mass (kg)
Ring Docking Device	24	1	24
Batteries	4	1	4
Power	6	1	6
Solar Arrays	7	2	14
Processor	3	1	3
Pan-Tilt	2	1	2
Communications	3	1	3
Structure	10	1	10
Propulsion System	5	1	5
Propellants	20	1	19
Margin	9	1	10
Subtotal			100
Additional propellants			160
Additional tankage structure			20
Additional margin			20
Total Additional			200
Total Mass			300
Dry Mass			121
Total Fuel Mass			179
Fuel Mass Fraction			0.60

Table 9.1: Mini-Class Servicer Mass Breakout

Component	Mass (kg)
Propellant	240
Vehicle	30
Margin	30
Total Mass	300
Dry Mass	60
Fuel Mass Fraction	0.80

Table 9.2: GasPod Mass Breakout

9.2 Servicer Operations Concept

The targets for Mini-Class servicing operations are typical commercial geosynchronous communications satellites near end of life. Given an assignment, the Mini will transition from a parking orbit (between geosynchronous and the graveyard) to a target in geosynchronous. It will rendezvous and dock with the target and then transfer that target to the graveyard orbit. Once there, the Mini will release the target and then return to its parking orbit to await additional tasking.

The approach for this servicing concept is to launch the servicer and additional fuel deliveries (GasPods) as auxiliary payloads on a geosynchronous launch vehicle. For an Ariane 5, launch cost for a 300 kg “Mini” payload is quoted as 7.5 MEUR in [17] in July, 2004, which converts to \$9.2M. After launch vehicle shut down in GTO, the Mini transfers itself to geosynchronous and begins providing geosynchronous retirement services. Between missions, the spacecraft parks in an orbit above geosynchronous but below the graveyard orbit. As fuel is depleted, a GasPod is launched and transfers itself to near geosynchronous. The Mini will then rendezvous with the GasPod, transfer fuel to itself, remove the empty GasPod to the graveyard orbit, and finally return to its parking orbit to await additional tasking. Note that a 1% chance of refuel failure is used for the GasPod to Mini fuel transfer because the design of this fuel transfer interface is fully controlled by the servicer designer (versus an unmodified ground fill port). Figure 9.2 shows the fuel accounting for the initial fuel load of the servicer. Figure 9.3 shows the fuel accounting for the n^{th} fuel load of the servicer. Table 9.3 includes description of the columns in those two previous figures. Table 9.4 shows the fuel onboard the Mini at the end of each stage of operations. This table illustrates the basic pattern of servicing until near fuel depletion and then refueling from a GasPod. From this table, also note the expenditure of an average of 6.5 kg of fuel per service provided. For a fee of \$10.9M, this results in an unburdened value of

\$1.7M per kg of fuel expended. Given a delivery-only cost of \$0.031M per kg (300 kg Mini launched for \$9.2M), a very large potential return can again be inferred.

Column	Description
Trip	Number of targets serviced
Svcr Initial Mass (kg)	Total mass of the servicer at start of mission
Target Initial Mass (kg)	Mass of the target satellite
Isp (s)	Speciifc impulse of the servicer's fuel
Park Alt (km)	Altitude of parking orbit above GEO
GY Alt (km)	Altitude of graveyard orbit above GEO
v Park To GEO (km/s)	Delta-V for maneuver from parking orbit to GEO
m Park To GEO (kg)	Fuel mass expended for Delta-V expended
Docking Fuel Cost (kg)	Fuel mass expended in rendezvous and docking ops
Srvcr Mass (kg)	Servicer mass in GEO
To GEO Mass (kg)	Combined servicer and target vehicle mass
v GEO to GY (km/s)	Delta-V for maneuver from GEO to graveyard orbit
m GEO to GY (kg)	Fuel mass expended for Delta-V expended
Srvcr Mass (kg)	Servicer mass after release of target vehicle
v GY to Park (km/s)	Delta-V for graveyard orbit to parking orbit
m GY to Park (kg)	Fuel mass expended for Delta-V expended
Srvcr Mass (kg)	Servicer mass at end of mission
Fuel Mass (kg)	Total expended fuel mass for mission

Table 9.3: Description Of Columns In Fuel Load Accounting

Trip	Svcr		Target		Park Alt (km)	GY Alt (km)	Av To GEO (km/s)	Δm To GEO (kg)	Docking		Svcr Mass (kg)	To GEO Mass (kg)	Δv GEO to GY (km/s)	GEO to GY (kg)	Δm	Av GY to Park (km/s)	GY to Park (kg)	Svcr Mass (kg)	Fuel Mass (kg)	Fuel Mass (kg)
	Initial Mass (kg)	Mass (kg)	Initial Mass (kg)	Mass (kg)					Fuel Cost (kg)	Fuel Cost (kg)										
1	189.5	1500	325	200	300	0.007	0.431	0.2	188.9	1689	0.011	5.754	183.2	0.004	0.208	183.0	6.6			
2	183.0	1500	325	200	300	0.007	0.417	0.2	182.4	1682	0.011	5.731	176.6	0.004	0.200	176.4	6.5			
3	176.4	1500	325	200	300	0.007	0.402	0.2	175.8	1676	0.011	5.709	170.1	0.004	0.193	169.9	6.5			
4	169.9	1500	325	200	300	0.007	0.387	0.2	169.4	1669	0.011	5.687	163.7	0.004	0.185	163.5	6.4			
5	163.5	1500	325	200	300	0.007	0.372	0.2	163.0	1663	0.011	5.665	157.3	0.004	0.178	157.1	6.4			
6	157.1	1500	325	200	300	0.007	0.358	0.2	156.6	1657	0.011	5.644	151.0	0.004	0.171	150.8	6.3			
7	150.8	1500	325	200	300	0.007	0.343	0.2	150.3	1650	0.011	5.622	144.7	0.004	0.164	144.5	6.3			
8	144.5	1500	325	200	300	0.007	0.329	0.1	144.1	1644	0.011	5.601	138.5	0.004	0.157	138.3	6.2			
9	138.3	1500	325	200	300	0.007	0.315	0.1	137.8	1638	0.011	5.580	132.3	0.004	0.150	132.1	6.2			
10	132.1	1500	325	200	300	0.007	0.301	0.1	131.7	1632	0.011	5.559	126.1	0.004	0.143	126.0	6.1			
11	126.0	1500	325	200	300	0.007	0.287	0.1	125.6	1626	0.011	5.538	120.0	0.004	0.136	119.9	6.1			

Figure 9.2: Mini-Class First Fuel Load

Trip	Svcr Initial		Park Alt (km)	GY Alt (km)	Av To GEO (km/s)	Am Park To		Docking		Svcr Mass (kg)	GEO Mass (kg)	Av GEO to GY (km/s)	Am GEO to GY		Svcr Mass (kg)	Av GY to Park (km/s)	Am GY to Park		Svcr Mass (kg)	Fuel Mass (kg)
	Mass (kg)	Mass (kg)				Fuel Cost (kg)	Fuel Cost (kg)	Mass (kg)	Mass (kg)				Mass (kg)	Mass (kg)			Mass (kg)	Mass (kg)		
1	260.0	1500	325	200	300	0.007	0.592	0.3	259.1	1759	0.011	5.993	253.1	0.004	0.287	252.8	7.1	252.8	7.1	
2	252.8	1500	325	200	300	0.007	0.576	0.3	252.0	1752	0.011	5.969	246.0	0.004	0.279	245.8	7.1	245.8	7.1	
3	245.8	1500	325	200	300	0.007	0.559	0.2	244.9	1745	0.011	5.945	239.0	0.004	0.271	238.7	7.0	238.7	7.0	
4	238.7	1500	325	200	300	0.007	0.543	0.2	238.0	1738	0.011	5.921	232.0	0.004	0.263	231.8	7.0	231.8	7.0	
5	231.8	1500	325	200	300	0.007	0.528	0.2	231.0	1731	0.011	5.897	225.1	0.004	0.255	224.9	6.9	224.9	6.9	
6	224.9	1500	325	200	300	0.007	0.512	0.2	224.1	1724	0.011	5.874	218.2	0.004	0.247	218.0	6.9	218.0	6.9	
7	218.0	1500	325	200	300	0.007	0.496	0.2	217.3	1717	0.011	5.850	211.4	0.004	0.240	211.2	6.8	211.2	6.8	
8	211.2	1500	325	200	300	0.007	0.481	0.2	210.5	1711	0.011	5.827	204.7	0.004	0.232	204.4	6.8	204.4	6.8	
9	204.4	1500	325	200	300	0.007	0.465	0.2	203.8	1704	0.011	5.804	198.0	0.004	0.224	197.7	6.7	197.7	6.7	
10	197.7	1500	325	200	300	0.007	0.450	0.2	197.1	1697	0.011	5.782	191.3	0.004	0.217	191.1	6.6	191.1	6.6	
11	191.1	1500	325	200	300	0.007	0.435	0.2	190.5	1690	0.011	5.759	184.7	0.004	0.209	184.5	6.6	184.5	6.6	
12	184.5	1500	325	200	300	0.007	0.420	0.2	183.9	1684	0.011	5.737	178.2	0.004	0.202	178.0	6.5	178.0	6.5	
13	178.0	1500	325	200	300	0.007	0.405	0.2	177.4	1677	0.011	5.714	171.7	0.004	0.194	171.5	6.5	171.5	6.5	
14	171.5	1500	325	200	300	0.007	0.390	0.2	170.9	1671	0.011	5.692	165.2	0.004	0.187	165.0	6.4	165.0	6.4	
15	165.0	1500	325	200	300	0.007	0.376	0.2	164.5	1664	0.011	5.671	158.8	0.004	0.180	158.6	6.4	158.6	6.4	
16	158.6	1500	325	200	300	0.007	0.361	0.2	158.1	1658	0.011	5.649	152.5	0.004	0.173	152.3	6.3	152.3	6.3	
17	152.3	1500	325	200	300	0.007	0.347	0.2	151.8	1652	0.011	5.627	146.2	0.004	0.166	146.0	6.3	146.0	6.3	
18	146.0	1500	325	200	300	0.007	0.332	0.1	145.5	1646	0.011	5.606	139.9	0.004	0.159	139.8	6.2	139.8	6.2	
19	139.8	1500	325	200	300	0.007	0.318	0.1	139.3	1639	0.011	5.585	133.7	0.004	0.151	133.6	6.2	133.6	6.2	
20	133.6	1500	325	200	300	0.007	0.304	0.1	133.1	1633	0.011	5.564	127.6	0.004	0.145	127.4	6.1	127.4	6.1	
21	127.4	1500	325	200	300	0.007	0.290	0.1	127.0	1627	0.011	5.543	121.5	0.004	0.138	121.3	6.1	121.3	6.1	
22	121.3	1500	325	200	300	0.007	0.276	0.1	120.9	1621	0.011	5.522	115.4	0.004	0.131	115.3	6.1	115.3	6.1	
23	115.3	1500	325	200	300	0.007	0.262	0.1	114.9	1615	0.011	5.502	109.4	0.004	0.124	109.3	6.0	109.3	6.0	

Figure 9.3: Mini-Class n^{th} Fuel Load

Mini Operations	Target Serviced	Onboard Fuel Mass (kg)	Fuel Mass Per Service (kg)	Note
At Launch		179.0		Launch
From GTO To Park		68.5		
From Park To GEO, GY, Park	1	62.0	6.6	
From Park To GEO, GY, Park	2	55.4	6.5	
From Park To GEO, GY, Park	3	48.9	6.5	
From Park To GEO, GY, Park	4	42.5	6.4	
From Park To GEO, GY, Park	5	36.1	6.4	
From Park To GEO, GY, Park	6	29.8	6.3	
From Park To GEO, GY, Park	7	23.5	6.3	
From Park To GEO, GY, Park	8	17.3	6.2	
From Park To GEO, GY, Park	9	11.1	6.2	
From Park To GEO, GY, Park	10	5.0	6.1	
From Park To GasPod, GY, Park		139.0		Refuel
From Park To GEO, GY, Park	11	131.8	7.1	
From Park To GEO, GY, Park	12	124.8	7.1	
From Park To GEO, GY, Park	13	117.7	7.0	
From Park To GEO, GY, Park	14	110.8	7.0	
From Park To GEO, GY, Park	15	103.9	6.9	
From Park To GEO, GY, Park	16	97.0	6.9	
From Park To GEO, GY, Park	17	90.2	6.8	
From Park To GEO, GY, Park	18	83.4	6.8	
From Park To GEO, GY, Park	19	76.7	6.7	
From Park To GEO, GY, Park	20	70.1	6.6	1 Yr.
From Park To GEO, GY, Park	21	63.5	6.6	
From Park To GEO, GY, Park	22	57.0	6.5	
From Park To GEO, GY, Park	23	50.5	6.5	
From Park To GEO, GY, Park	24	44.0	6.4	
From Park To GEO, GY, Park	25	37.6	6.4	
From Park To GEO, GY, Park	26	31.3	6.3	
From Park To GEO, GY, Park	27	25.0	6.3	
From Park To GEO, GY, Park	28	18.8	6.2	
From Park To GEO, GY, Park	29	12.6	6.2	
From Park To GEO, GY, Park	30	6.4	6.1	
From Park To GasPod, GY, Park		140.4		Refuel

Table 9.4: Mini Operations Fuel Accounting

9.3 Application Of The New Feasibility Methodology

While the expected-value break-even servicing fees in the previous chapter were found on a per mission basis, to evaluate a proposed servicer, the event probabilities for the entire scenario must be linked together. The expected value per service is still the same to the satellite’s operator, but here the value to the service providing organization will be determined.

The costs to the servicing organization are shown in Table 9.5. First and n^{th} unit costs were found using the Spacecraft/Launch Vehicle Cost Model [35] which is based on NAFCOM [15]. These models include launch and orbital operations support costs for the first year of operations. To break out the annual operations costs beyond the first year, small spacecraft CERs (applying twice the standard error to be conservative) for operations costs from [106] were used.

Item	Cost (\$M)
Cost For The First Mini	53.9
Cost For The First GasPod	36.7
Annual Operations Costs (Beyond First Year)	3.3
Cost For The n^{th} Mini	10.5
Cost For The n^{th} GasPod	6.6
Launch Cost	9.2

Table 9.5: Mini Program Costs

Tables 9.6 and 9.7 show the application of the expected value method. The “Event” column indicates the phase of Mini’s life. The “Cost, Benefit (\$M)” column indicates the cost or benefit accrued during that phase. The “Chance Of Failure” column corresponds to the failure probabilities identified in the previous chapter. The initial Launch failure probability (10.3%) is the sum of the chance of launch failure (4.8%), the chance of wrong orbit (3.1%), and the chance of infant mortality (2.4%).

The “Probability Of Continuing Success” column indicates likelihood of continuing mission success. Because these are serial activities, each additional chance of failure diminishes the chance of continuing success accordingly. The “Expected Value (\$M)” column indicates the expected value of the entries in the “Cost, Benefit (\$M)” column (vehicle and launch expenses are , of course, charged directly). Finally, the “Total Expected Value (\$M)” column indicates running total expected value of the serving mission.

The expected value (“Total Expected Value (\$M)” from Table 9.6) and the unmodified costs and benefits (“Cost, Benefit (\$M)”) are plotted in Figure 9.4. Here one can see the difference between the new method and the old. The “Cost, Benefits” line is a simple summation of scenario costs and benefits as they occur. This then shows the predicted value for the servicing mission predicted by previous models. The lower line shows the more economically conservative prediction generated using the expected value method. Because there are, on average, 20 GEO retirement opportunities per year, this figure (with only 10 missions) encompasses about a half a year of operations. Because the graveyard orbit and GEO orbit are both nearly 24 hour orbits, each of the transitions listed takes about a half a day. Therefore, if the servicer were assigned a new task immediately after each previous task was completed, it could perform nearly one service per day. Over the course of a 365 day year there are only expected to be 20 such opportunities, therefore, this is a target limited queue. Of course, rendezvous orbit phasing time must be accounted for, but 18 days per mission appears more than sufficient.

What does Figure 9.4 demonstrate? It shows economic feasibility of the proposed servicer. Break-even is achieved after target 8 is retired. It also shows that the new method is more conservative, hence realistic, than the old method where break-even was predicted after target 6 was serviced. After 10 missions, the Mini’s fuel supply is nearly exhausted. One could terminate operations here with a net gain.

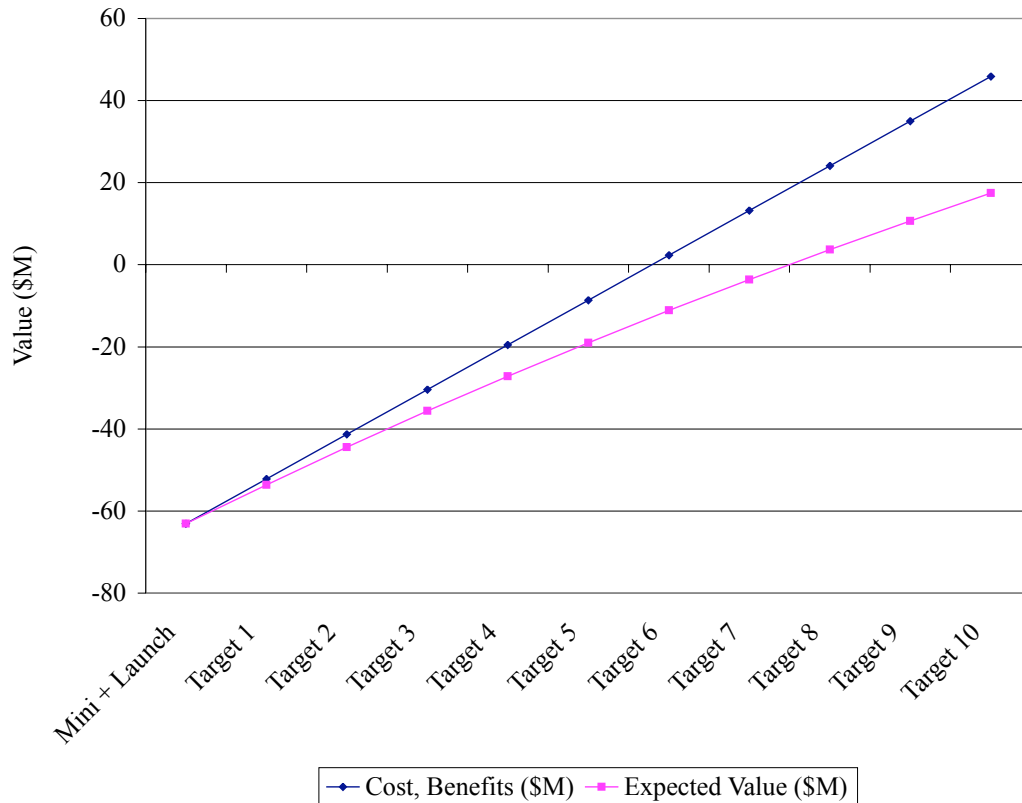

Figure 9.4: Expected Values By Target Serviced, First Mini

This scenario represents an annual expected value of \$34.8M per year (two of these 10 mission sets). For Mini success throughout the scenario, the maximum annual value is \$91.8M per year (again, two mission sets).

Another option is to continue resupplying the Mini with fuel. Refueling the servicer can be accomplished by launching a GasPod. After rendezvous, docking, fuel transfer, and disposal of the GasPod, this will provide the Mini with fuel to perform another 20 missions (see Figure 9.3 for fuel mass accounting). Figure 9.5 illustrates such a scenario. Note that the vehicle and launch cost for the GasPod are assessed after mission 10 and operations costs for a second year are assessed just after mission 20. Again, overall profitability is predicted. This scenario represents an

annual expected value of \$31.3M per year (two thirds of the value of the 30 mission set). For Mini success throughout the scenario, the maximum annual value is \$143.1M per year (also two thirds of the value of the 30 mission set).

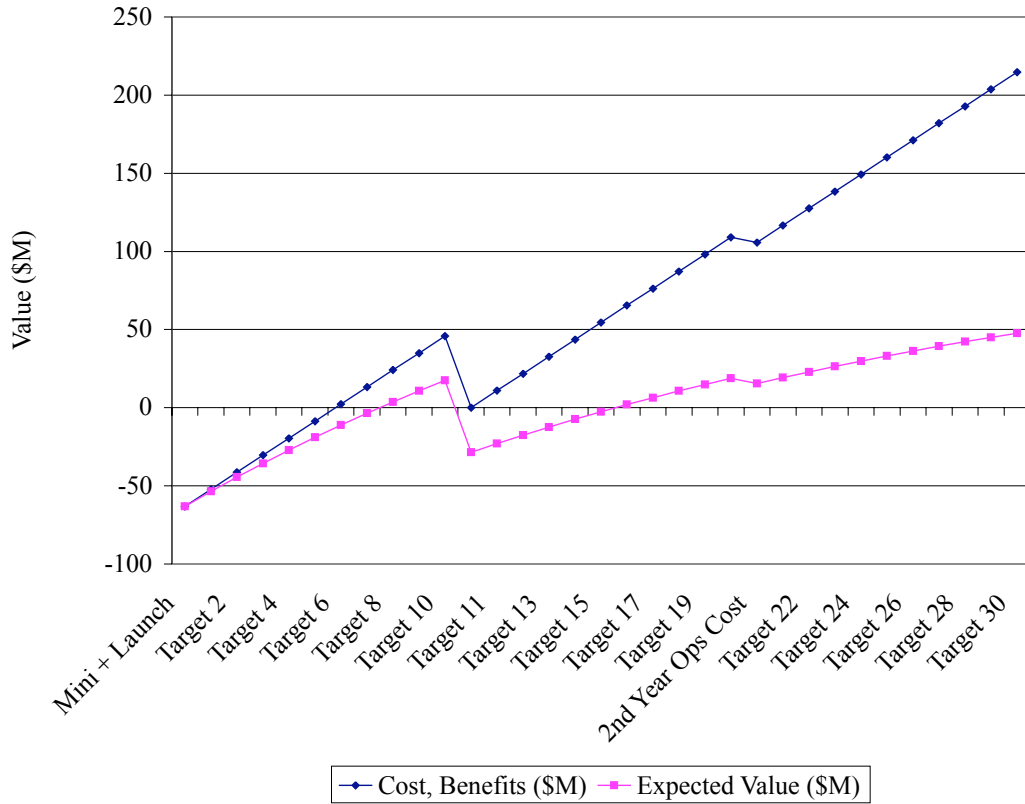

Figure 9.5: Expected Values By Target Serviced, First Mini, First GasPod Added

Another view of the costs and expected values is shown in Figure 9.6. The X-axis is accumulated total program costs (vehicles, launch, and operations) and the Y-axis is accumulated total expected value (servicing fees). Totals above the diagonal line represent profitability and those below represent a deficit. Break-even is shown to occur after the 8th mission for the Mini alone. Adding a GasPod, the new break-even occurs after mission 16.

The previous graphs were for the first Mini and first GasPod. Using the values

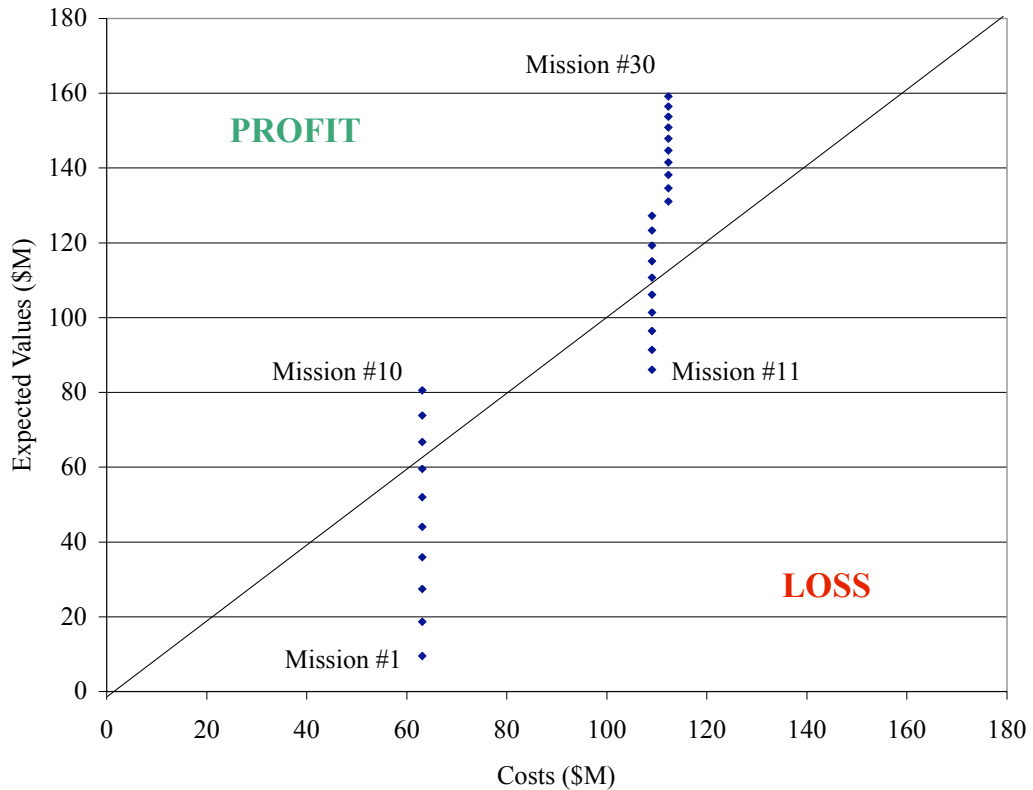

Figure 9.6: Expected Values Versus Costs For First Mini And First GasPod Scenario

from Table 9.5 for the n^{th} versions, Figure 9.7 is generated. This indicates an even higher expected profitability. Again, the lower line represents the expected value given the operational hazards. Were the Mini and GasPod to accomplish this entire scenario, the final profit of the upper line would be achieved. This scenario represents an annual expected value of \$82.5M per year (two thirds of the value of the 30 mission set). For Mini success throughout the scenario, the maximum annual value is \$192.1M per year (also two thirds of the value of the 30 mission set).

Another view of the costs and expected values is shown in Figure 9.8. The X-axis is accumulated total program costs (vehciles, launch, and operations) and the Y-axis is accumulated total expected value (servicing fees). Totals above the diagonal

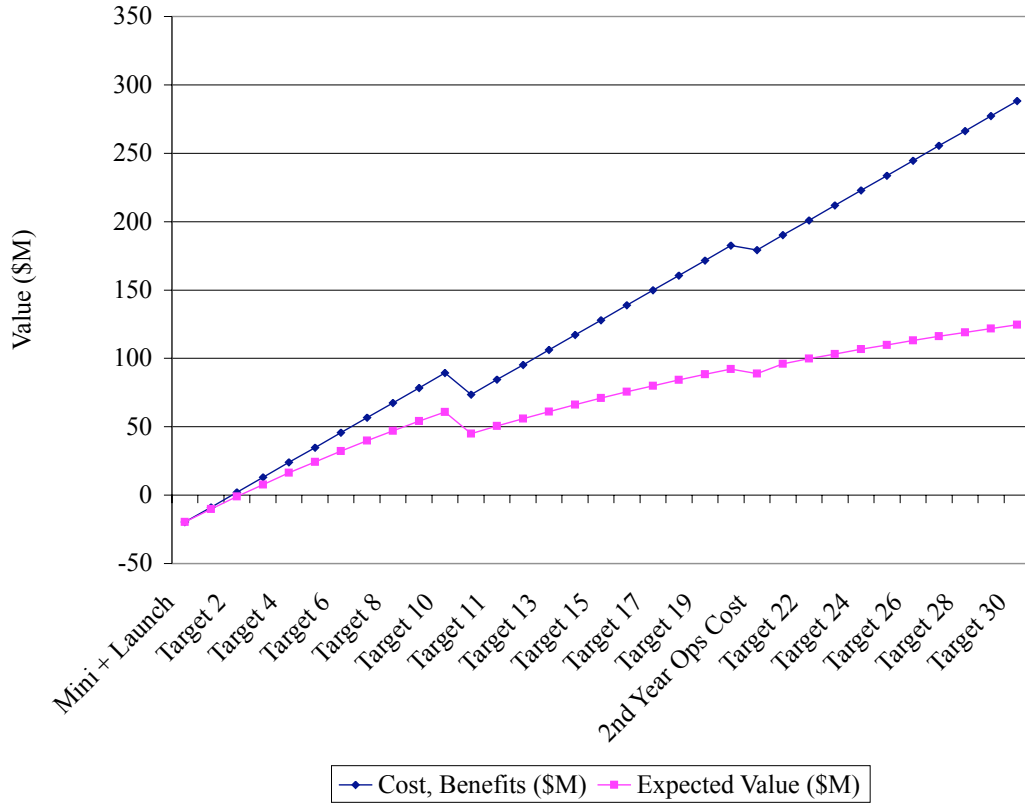

Figure 9.7: Expected Values By Target Serviced, n^{th} Mini, n^{th} GasPod Added

line represent profitability and those below represent a deficit. Break-even is shown to occur after the 3rd mission for the Mini alone. Adding a GasPod in this case does not take the system back into deficit.

To check the sensitivity of these results to variations in $pDockFail$, Figure 9.9 shows the same scenario with a docking failure rate of 10% (with commensurately reduced break-even servicing fees of \$9.9M). This scenario represents an annual expected value of \$15.1M per year (two thirds of the value of the 30 mission set). For Mini success throughout the scenario, the maximum annual value is \$172.1M per year. Given how the expected value curve flattens out, this indicates that this is nearing the maximum rate that $pDockFail$ can have while still remaining a feasible scenario.

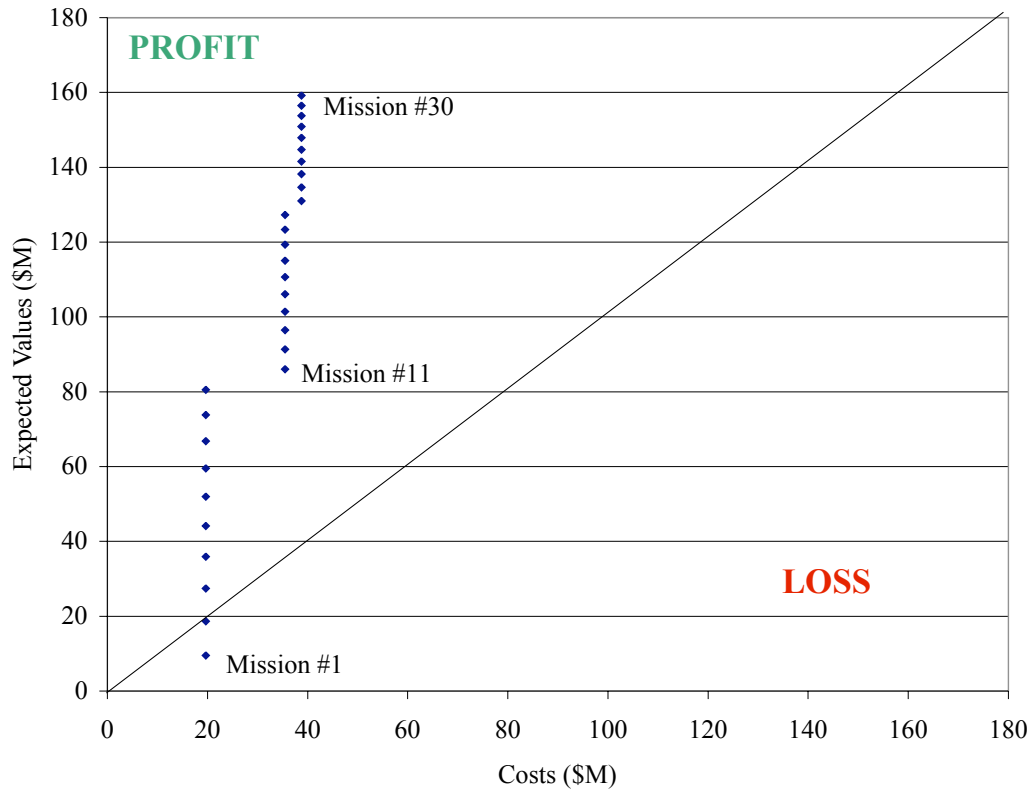

Figure 9.8: Expected Values Versus Costs For n^{th} Mini And n^{th} GasPod Scenario

Still, this demonstration of the expected value approach for assessing servicing scenarios is shown to be more economically conservative than the standard approach. Also, the analysis shown in this chapter indicates that the proposed servicer design merits further development.

A further examination of $pDockFail$ from 1 to 15% is shown in Table 9.8. Again the flat curve at 10% indicates marginal profitability and 15% line shows no chance of long term viability.

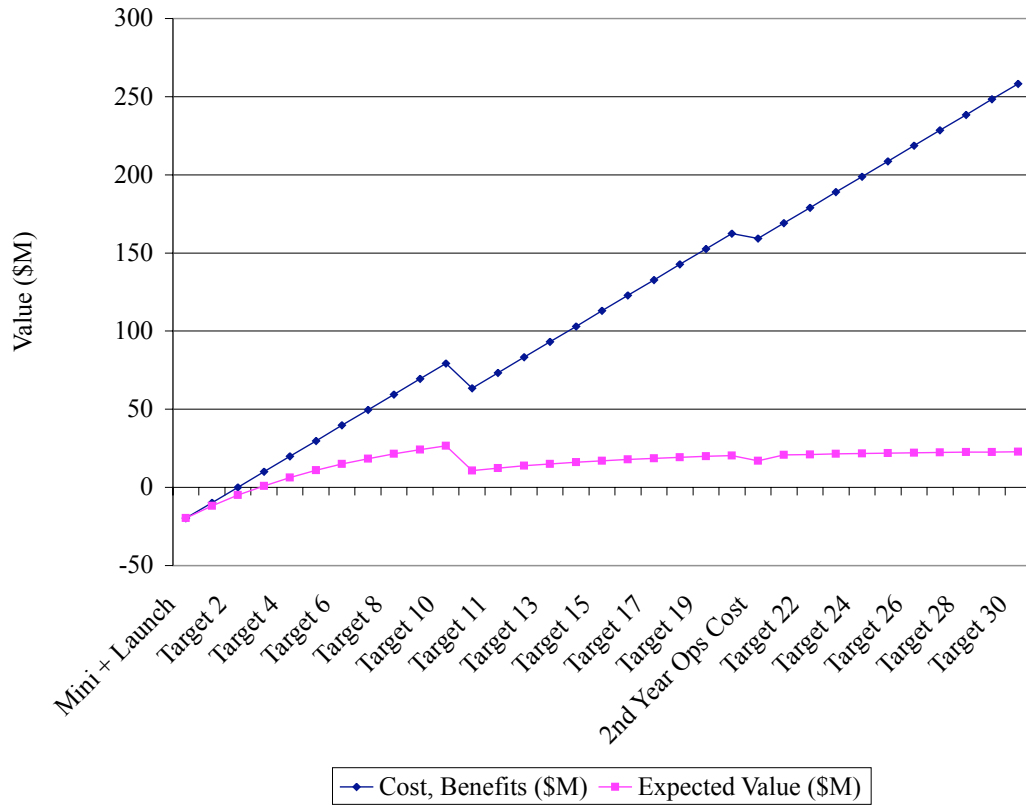

Figure 9.9: Expected Values By Target Serviced, n^{th} Mini, n^{th} GasPod Added, $pDockFail$ is 10%

Event	Cost, Benefit (\$M)	Chance Of Failure	Probability Of Continuing Success	Expected Value (\$M)	Total Expected Value (\$M)
First Mini	-53.9			-53.9	-53.9
Launch	-9.2	0.103	0.897	-9.2	-63.1
Mini To Park		0.006	0.892		-63.1
Mini To GEO		0.006	0.886		-63.1
Dock		0.01	0.877		-63.1
Mini To GY		0.006	0.872		-63.1
Servicing Fee	10.9		0.872	9.5	-53.6
Undock		0.01	0.863		-53.6
Mini To Park		0.006	0.858		-53.6
Mini To GEO		0.006	0.853		-53.6
Dock		0.01	0.845		-53.6
Mini To GY		0.006	0.839		-53.6
Servicing Fee	10.9		0.839	9.2	-44.4
Undock		0.01	0.831		-44.4
Mini To Park		0.006	0.826		-44.4
Mini To GEO		0.006	0.821		-44.4
Dock		0.01	0.813		-44.4
Mini To GY		0.006	0.808		-44.4
Servicing Fee	10.9		0.808	8.8	-35.6
Undock		0.01	0.800		-35.6
Mini To Park		0.006	0.795		-35.6
Mini To GEO		0.006	0.790		-35.6
Dock		0.01	0.783		-35.6
Mini To GY		0.006	0.778		-35.6
Servicing Fee	10.9		0.778	8.5	-27.2
Undock		0.01	0.770		-27.2
Mini To Park		0.006	0.765		-27.2
Mini To GEO		0.006	0.761		-27.2
Dock		0.01	0.753		-27.2
Mini To GY		0.006	0.749		-27.2
Servicing Fee	10.9		0.749	8.2	-19.0

Table 9.6: Mini Scenario, Expected Value Accounting

Event	Cost, Benefit (\$M)	Chance Of Failure	Probability Of Continuing Success	Expected Value (\$M)	Total Expected Value (\$M)
Servicing Fee	10.9		0.749	8.2	-19.0
Undock		0.01	0.741		-19.0
Mini To Park		0.006	0.737		-19.0
Mini To GEO		0.006	0.732		-19.0
Dock		0.01	0.725		-19.0
Mini To GY		0.006	0.721		-19.0
Servicing Fee	10.9		0.721	7.9	-11.1
Undock		0.01	0.713		-11.1
Mini To Park		0.006	0.709		-11.1
Mini To GEO		0.006	0.705		-11.1
Dock		0.01	0.698		-11.1
Mini To GY		0.006	0.694		-11.1
Servicing Fee	10.9		0.694	7.6	-3.6
Undock		0.01	0.687		-3.6
Mini To Park		0.006	0.683		-3.6
Mini To GEO		0.006	0.679		-3.6
Dock		0.01	0.672		-3.6
Mini To GY		0.006	0.668		-3.6
Servicing Fee	10.9		0.668	7.3	3.7
Undock		0.01	0.661		3.7
Mini To Park		0.006	0.657		3.7
Mini To GEO		0.006	0.653		3.7
Dock		0.01	0.647		3.7
Mini To GY		0.006	0.643		3.7
Servicing Fee	10.9		0.643	7.0	10.7
Undock		0.01	0.636		10.7
Mini To Park		0.006	0.632		10.7
Mini To GEO		0.006	0.629		10.7
Dock		0.01	0.622		10.7
Mini To GY		0.006	0.619		10.7
Servicing Fee	10.9		0.619	6.7	17.4

Table 9.7: Mini Scenario, Expected Value Accounting, Continued

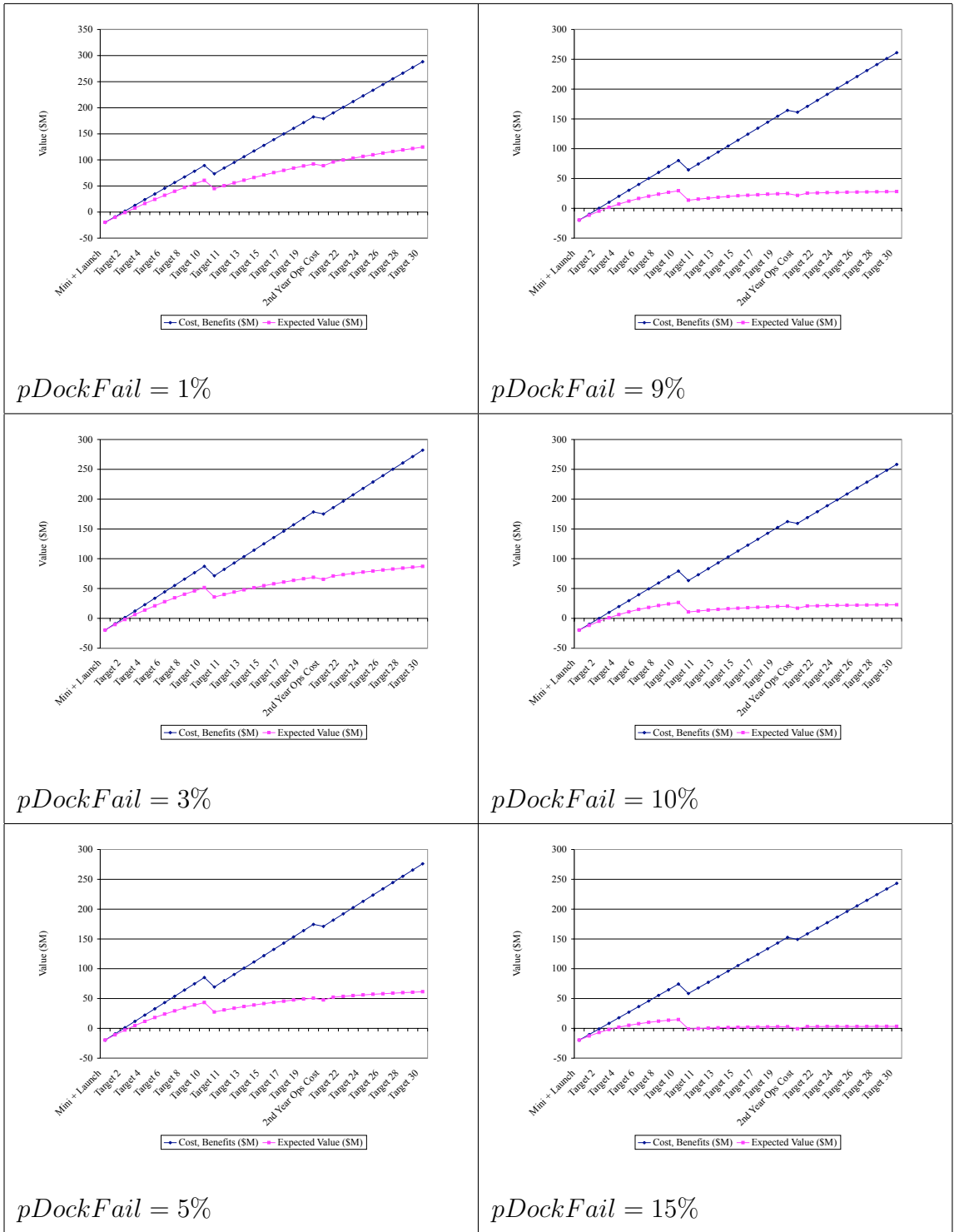

Table 9.8: Mini Scenario By Docking Failure Rate

Chapter 10

Conclusion

An improved method for evaluating the feasibility of telerobotic on-orbit satellite servicing was developed and demonstrated in this research. This chapter includes discussion of the discoveries made during the effort, a description of the contributions of this work to the state of the art, recommendations for additional research, and a final summary.

10.1 Results

Overall, the key discovery of this dissertation is the determination of the annual expected value break-even servicing fees for the various servicing market segments listed in Table 8.19. It shows that there are tens of servicing opportunities per year with total values in the \$100M's. Rather than simply pointing to the substantial sunk costs invested in geosynchronous communications satellites, this study provides an improved analytical basis for evaluating any proposed servicing system. After identifying a logical initial market segment to pursue, a final important finding is that a small, low mass, low cost servicer providing retirement maneuvers is a viable first step on the path to a servicing industry. The conclusions reached are discussed in more detail in the following subsections.

10.1.1 Assessment Of Previous Studies

Previous studies did not fully account for operational uncertainties. While they did account for the primary economic considerations of evaluating the costs and benefits of servicing versus replacement, they did not fully include the chance of failure in either scenario. Chance of launch failure, chance of servicing mishaps, and other hazards must be included to arrive at a more accurate evaluation of the economic comparison between the two options. The new method developed here addresses these operational uncertainties.

Previous studies did not include a comprehensive analysis of actual spacecraft lifetimes and failure events. These studies would typically pick a representative spacecraft and perform their analysis on that target. Conclusions would then be extended to the greater population of satellites with little consideration of whether the chosen sample satellite truly represented the median satellite or was in fact skewed to one end of the spectrum of spacecraft characteristics. In contrast, this analysis gathered information on all satellites and then used that knowledge to identify the average satellite to be used for analysis. This directly improves the accuracy of predictive capabilities of the new model over the previous approaches.

10.1.2 Identification Of Servicing Opportunities

Constructing a comprehensive spacecraft database was a critical component of this research. In the end, the spacecraft database contained information for 6,032 spacecraft launched from 1957 thru 2003. Overall, there were 20 fully populated mandatory fields per satellite and the database itself had over 300,000 filled fields with a total loading of 36% (ratio of populated fields to all fields). Key characteristics such as mass, fuel mass, orbital location, end of life information, transponder counts and others were accumulated.

Collecting and analyzing thousands of satellite orbital histories was essential to the understanding of operational lives of actual spacecraft. Sample plots of this data are included at the end of Appendix E. Over 10,000 such plots were generated in the analysis. A few hundred of these plots in particular provided key information on the relocation history of various high-value geosynchronous spacecraft. This history in turn enabled an assessment of the annual geosynchronous relocation market.

Constructing a comprehensive on-orbit failures database was also accomplished. The issue here was not in quantity of information but in paucity. Satellite manufacturers are understandably reluctant to publish any issues with their products. While some failure information was accumulated during the construction of the satellite information database, additional effort was directed at thoroughly investigating space industry news, magazines, books, annual reports, and websites for every report of satellite anomalies. Discovered information varied widely level of detail.

A number of surprising trends, directly affecting opportunities for servicing, in spacecraft characteristics were discovered from investigation into the spacecraft information database. For instance, a non-intuitive finding is that transponder bandwidth is not rising over time, rather geosynchronous communication spacecraft designs are growing larger and incorporating more transponders. This enables growth in the total bandwidth per spacecraft without a substantial growth in per transponder bandwidth. For servicers, a servicing-positive observation is that even with the slow down in geosynchronous launches over the previous few years, there has not been a year since 1986 in which there were less active satellites than the previous year, thus indicating a continuing demand for geosynchronous communications satellites. Such demand is a necessary, but not sufficient, condition to even consider a servicing system in that orbital regime. Another key trend is that a substantial number of spacecraft tend to outlive their design lives (by 30.0% of design life on average for geosynchronous communications satellites). Because initial fuel loads are sized to

meet spacecraft design life, this trend leads naturally to a motivation to investigate refueling or other propulsive services.

10.1.2.1 Opportunities To Service On-Orbit Failures

Analysis of the on-orbit failures database identified a variety of failure servicing opportunities. In Table 7.13 it was shown that nearly once a year a high value spacecraft intended for geosynchronous orbit fails to be delivered to the correct orbit. While some of these spacecraft were able to utilize onboard resources to achieve proper orbit, they did so with a significantly reduced lifetime fuel load. Others were left in such low orbits that they were abandoned or commanded to re-enter the Earth's atmosphere for controlled disposal. Opportunities for dexterous servicing such as deployment assistance, ORU-like repairs, and systemic repairs were also identified and occur with single digits of annual frequency.

For failure-only servicing, a dexterous servicer is strongly indicated by the percent of failures by type. Table 7.10 shows that nearly 60% of serviceable failures require a dexterous servicer.

10.1.2.2 Opportunities For Spacecraft Lifetime Extension

Analysis of the spacecraft information database revealed a number of lifetime extension servicing opportunities. The spacecraft information database and the associated orbital history files detail a steady number of annual opportunities to provide propulsive services to existing spacecraft. Any maneuver requiring a significant amount of lifetime fuel that can be performed by a servicer will enable the target spacecraft to conserve its fuel for other essential lifetime needs. Identified maneuvers include relocation in the operational orbit (20 per year) and a retirement maneuver out of the active orbit (about 20 per year). Refueling is also an attractive, though more dexterously challenging, servicing option (also 20 per year).

10.1.3 Determination Of Expected Value Outcomes And Probabilities

Application of the new method requires historical spacecraft operations information along with estimates of servicing failure rates. In order to evaluate the opportunities identified with the new servicing feasibility method, economic values for various servicing outcomes (Section 8.2) and probabilities (Section 8.1) of those outcomes occurring are required. For operations applicable to both replacement satellites and servicers (such as launch), the database provides a definitive chance of failure. New servicing operational uncertainties (such as docking) must currently be estimated, though sensitivity analysis of profitability to such parameters can now be performed with this new formulation of the satellite servicing problem.

10.1.4 Assessment Of Servicing Markets

Evaluation of the identified servicing opportunities using the new method allowed the establishment of an average annual servicing market size by mission type. Table 8.19 shows these values with a total annual expected value of \$2.4B, which is an economically significant result. After finding a minimum annual market segment size, taking robotic complexity and target vehicle time of life into account, geosynchronous retirement service was identified as a prime candidate as the first mission type to consider.

10.1.5 Evaluation Of A Proposed Servicer

Utilization of the new method for evaluating the feasibility of a proposed servicing system enabled an assessment based on real-world spacecraft cost-benefits including accounting for operational uncertainties. This new approach yielded a more accurate result than can be produced by previous methods. The proposed Mini-Class servicer

was found to break-even after providing retirement services to 8 targets.

10.1.6 Parametric Analysis Of The Required Docking Success Rate

Another important result is the determination that, for the geosynchronous retirement mission, the chance of successful docking must be 90% or better to yield a profitable system. Figure 9.9 in particular shows how the expected value curve for a system with a 10% chance of docking failure flattens out to become, at best, marginally profitable. This finding has immediate implications for servicing vehicle designers. Failure to implement a system with a less than 90% chance of docking success will result in an economically inviable system.

10.2 Contributions

The main contribution of this dissertation to the state of the art concerning assessing the feasibility of servicing is reformulation of the standard approach. Evaluating the satellite servicing problem with the new method enables a more real-world decision. By incorporating expected value calculations into the assessment of servicing scenarios, the approach developed in this dissertation allows for the inclusion of previously unaccounted for possibilities of failure for both the servicing and non-servicing scenarios. This is an essential feature that enables more informed economic decision-making when considering satellite servicing. Additional contributions are discussed in the following subsections.

10.2.1 Market Segment Selection

By defining and fully populating the annual satellite servicing market segmented by mission type, this dissertation enables potential satellite servicing organizations

to better decide which market segment to pursue first. Based on largest minimum anticipated market value, minimum robotic complexity, and minimum potential target spacecraft lifetime impact, retirement services for geosynchronous spacecraft was identified as the segment with which to start.

10.2.2 Operational Uncertainties

Identification and then determination or estimation of the entire set of probabilities of failure for operations in both the servicing and non-servicing scenarios has not been published before this dissertation. By collecting and analyzing historical spacecraft operations information, the failure probabilities for standard spacecraft operations were found. Because such operations have not yet been conducted, estimates for servicer-only operational failures were assigned preliminary values.

10.2.3 On-Orbit Failures By Type

Another valuable contribution is the determination of the historical percent of serviceable failures by failure type (Table 7.10). This breakout shows that for failure servicing (but not lifetime extension servicing) a dexterous servicer is required to fulfill the majority of the opportunities.

10.2.4 Overall Servicing Market Characterization

Application of the new method to the entire set of current spacecraft enabled the development of an annual satellite servicing market assessment based on break-even servicing fees (Table 8.19). These fees show the value of servicing to the satellite operators in the face of potential operational failures. Because these operational uncertainties are included, this is a more realistic approach than the standard form.

10.2.5 Feasibility Demonstration

Demonstration of the new method for a proposed servicer illustrates the utility of the method and the positive prospects for satellite servicing, including annual expected profit values in the \$10M's range for a small servicer providing retirement services for geosynchronous satellites. Because this is a less dexterously intensive option, a low mass, low cost servicer design is found to be both technically and economically feasible.

10.2.6 Determination Of Technology Performance Requirements

Determination of 10% as the cutoff value for the chance of docking failure in the geosynchronous retirement scenario is an important result. This informs servicer designers as to what level of performance is required in the reliability of future technology in order to justify such missions.

10.3 Recommendations

While the chance of launch anomalies and other failures applicable to current spacecraft are well documented here, developing a better estimate for the chances of docking failure ($p_{DockFail}$) and other servicer related operations will make this an even stronger tool. Because these are new activities, there is no historical database of operational outcomes for on-orbit telerobotic servicing. Further simulation and analysis of such operations is needed. Upcoming full 6 DOF docking simulations at the NRL robotics test-bed should begin to provide more accurate estimates of the probability of success for these operations.

In order to assess the near term viability of telerobotic on-orbit satellite ser-

ving, this research was conducted with an eye towards servicing currently operating spacecraft. The redesign of future spacecraft to more readily accommodate servicing (such as refueling or ORU changeout) will greatly facilitate servicing, decrease the required robotic complexity, and reduce the chance of servicing mishaps. Application of the new method defined here to next-generation serviceable spacecraft will produce more economically realistic servicing assessments for those systems.

10.4 Final Summary

In this dissertation, an improved formulation of the satellite servicing equation has been established. By incorporating operational uncertainties into the servicing decision, a more accurate assessment is now possible. Determination of actual spacecraft failure rates and opportunities for lifetime extension based on the analysis of historical spacecraft operations provides a much more realistic method than any previously shown. The overall expected value market assessment and evaluation of a proposed small servicer for geosynchronous retirement operations clearly demonstrate the economic feasibility of telerobotic on-orbit satellite servicing.

Appendix A

Satellite Trends

The figures containing satellite populations by market, populations by orbit, and inclined lifetime surveys included in this appendix are derived from information in the satellite information database.

A.1 Satellites By Market

This section shows breakouts of payloads by market, where the markets are Civilian (CIV), Commercial (CML), and Military (MIL). A small number of payloads have been flown by Non-Governmental Organizations as well, but are not shown here. The civilian market includes government sponsored scientific, weather, and other satellites.

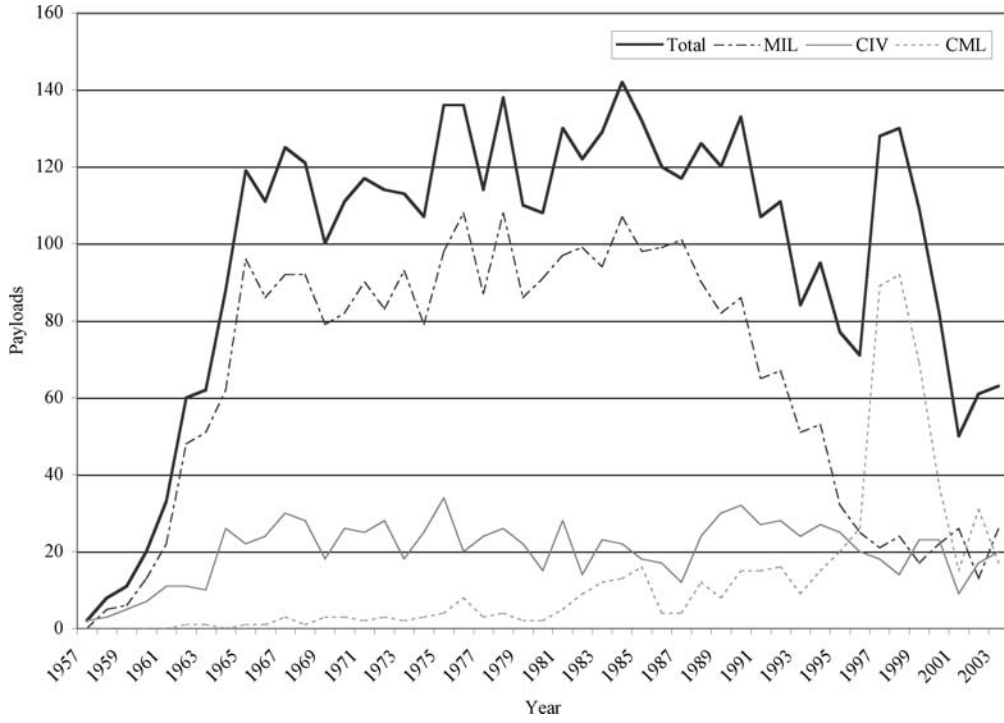

Figure A.1: Payloads By Market

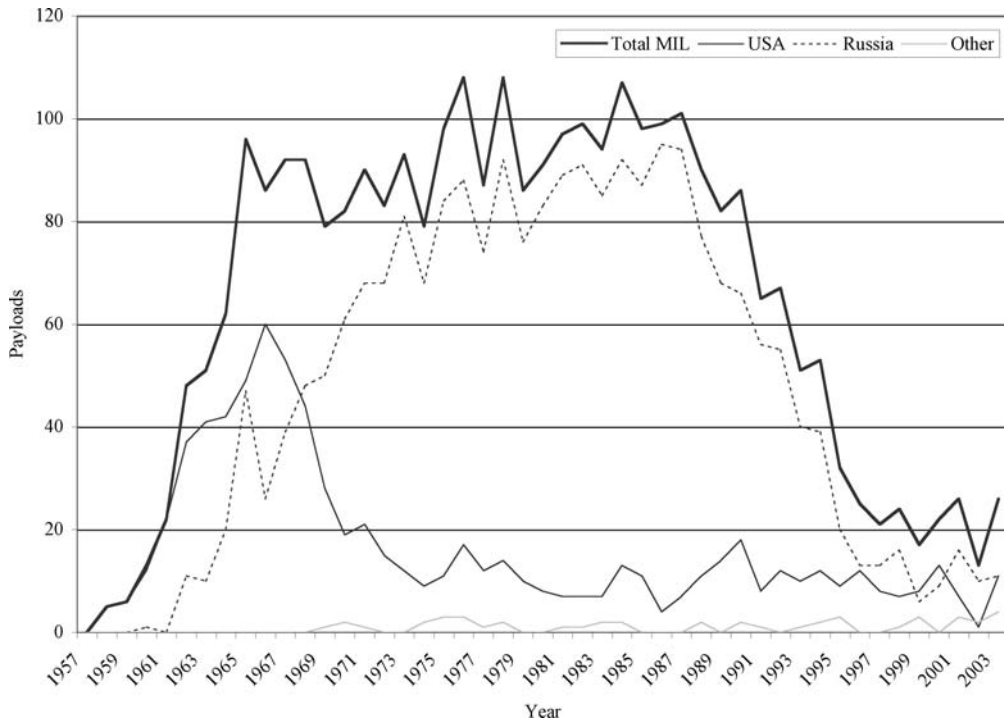

Figure A.2: Military Payloads By Country

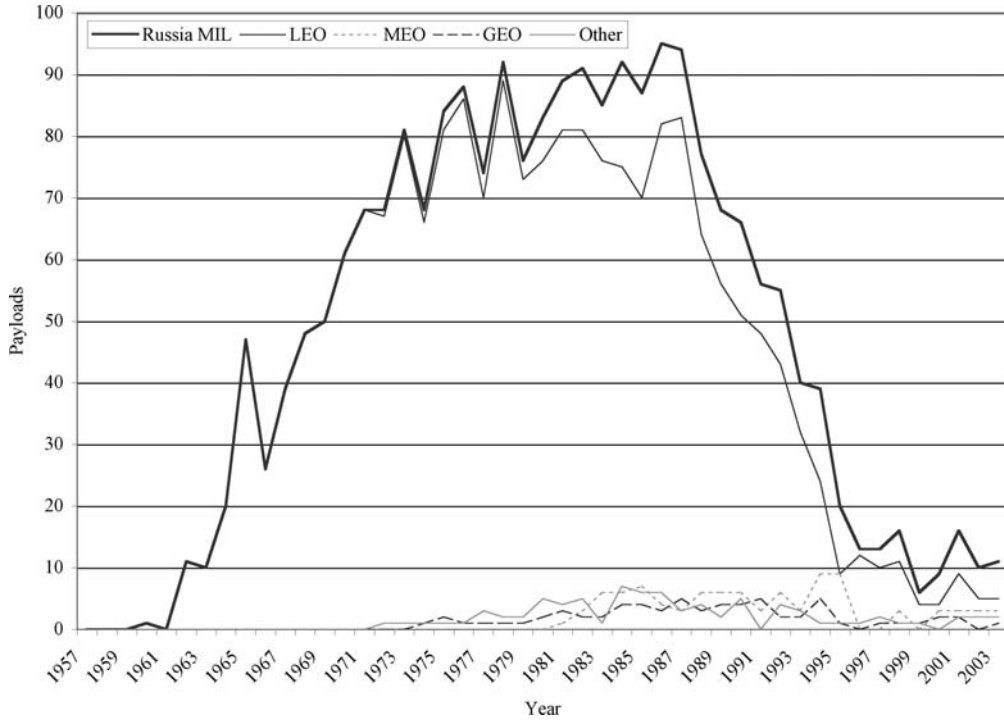

Figure A.3: Russian Military Payloads By Orbit

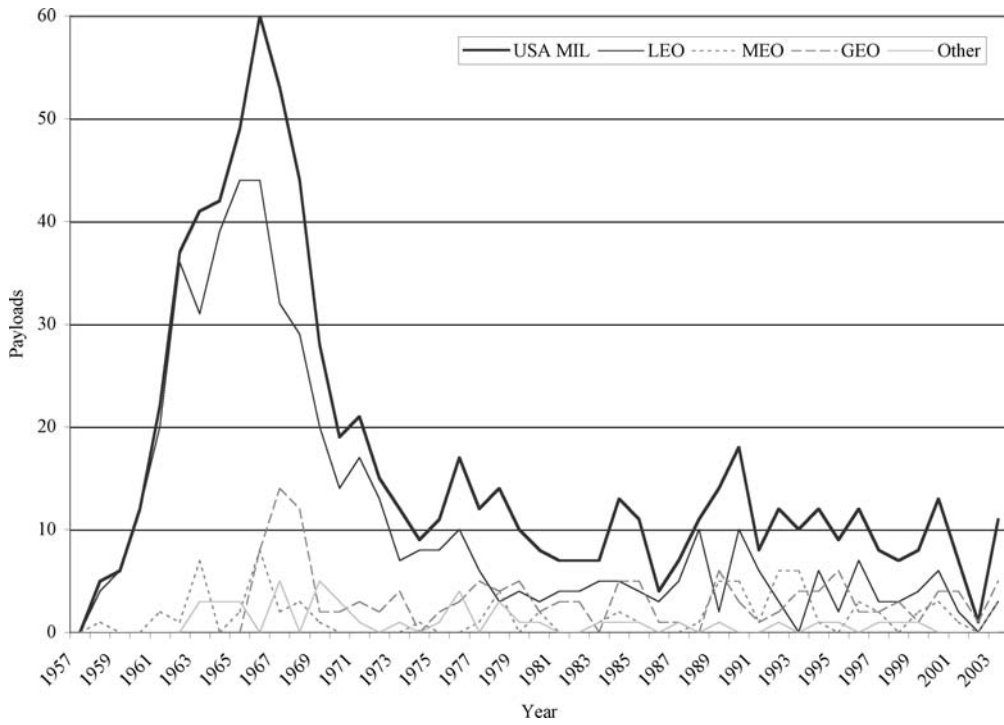

Figure A.4: United States Military Payloads By Orbit

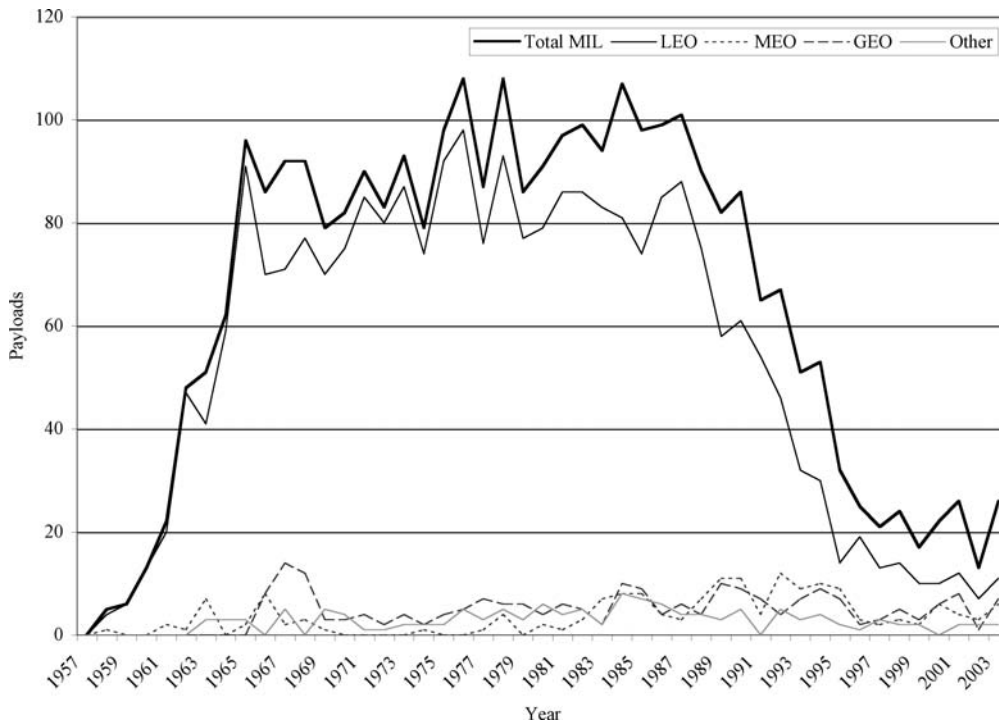

Figure A.5: Military Payloads By Orbit

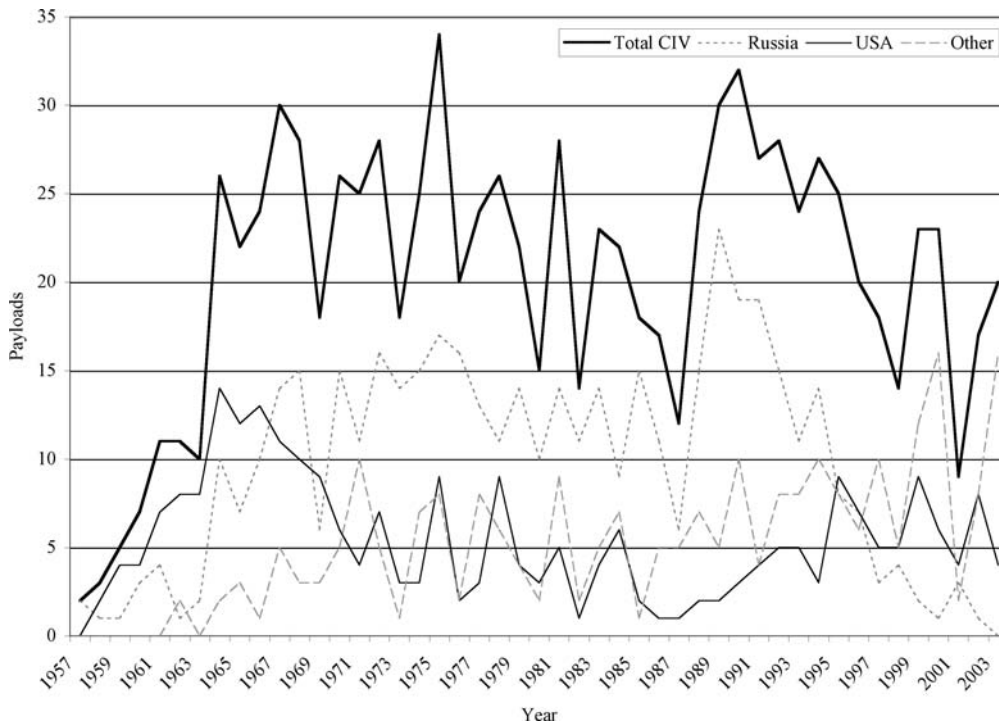

Figure A.6: Civilian Payloads By Country

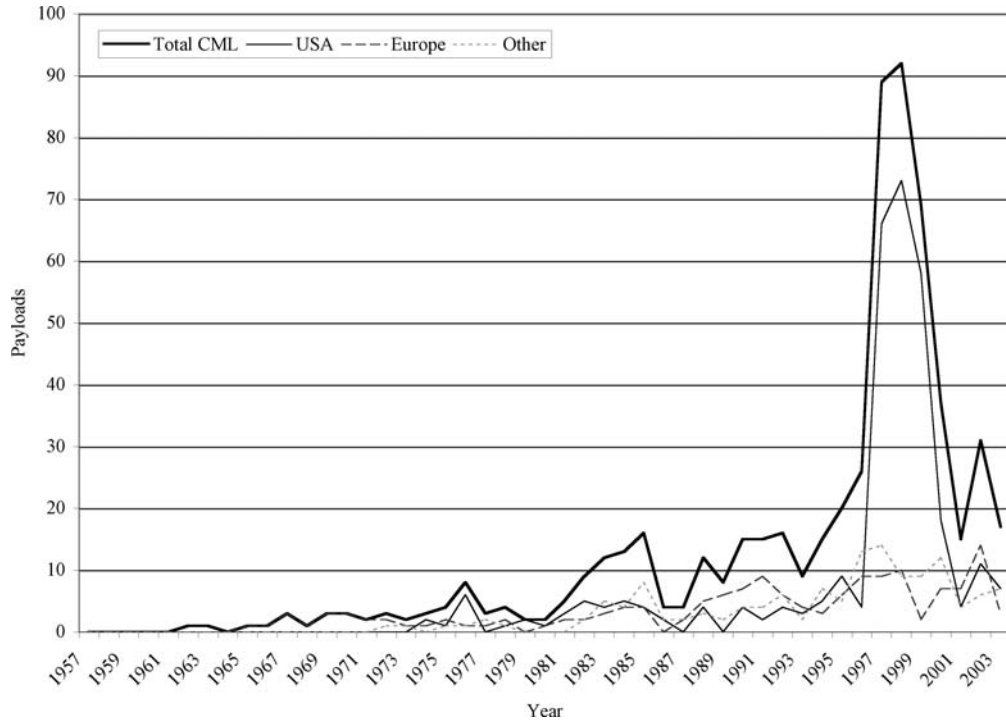

Figure A.7: Commercial Payloads By Country

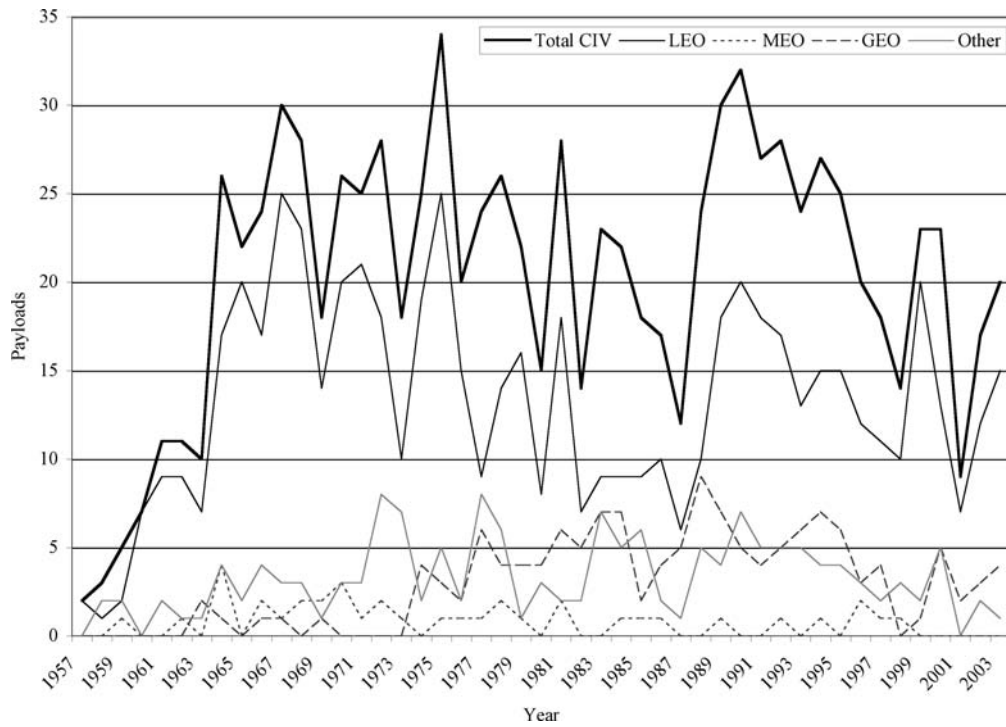

Figure A.8: Civilian Payloads By Orbit

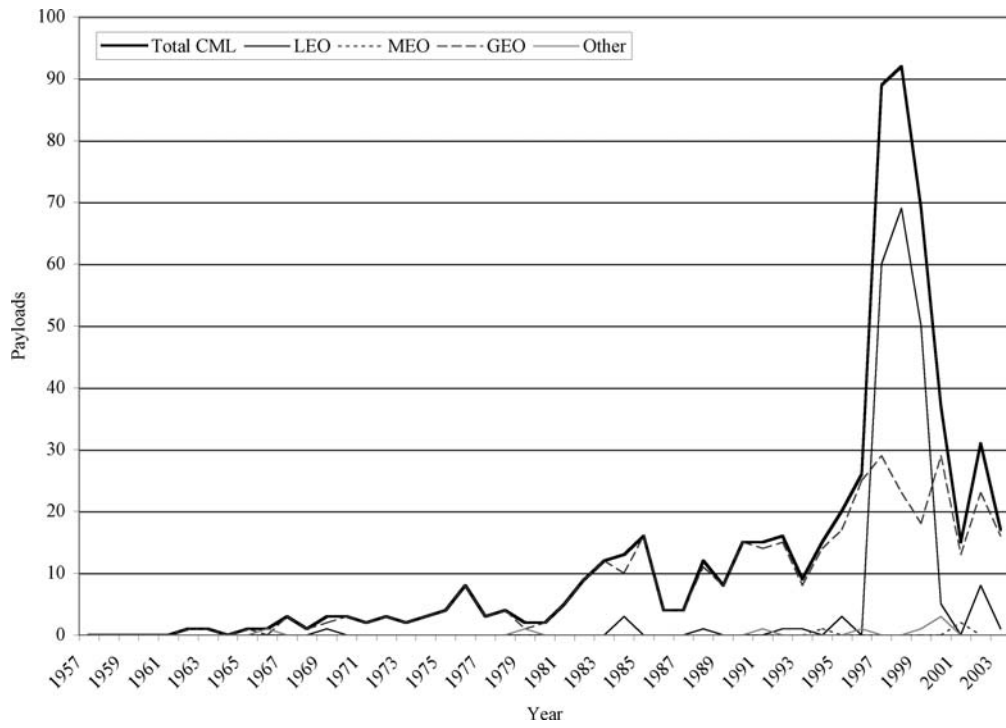

Figure A.9: Commercial Payloads By Orbit

A.2 Satellites By Orbit

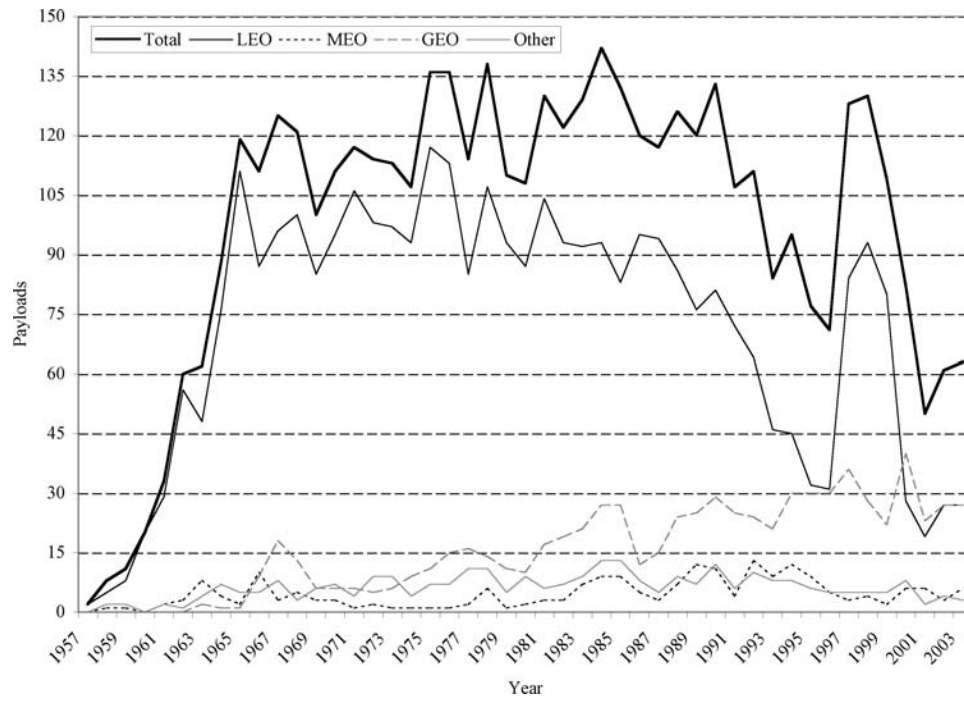

Figure A.10: Payloads By Orbit

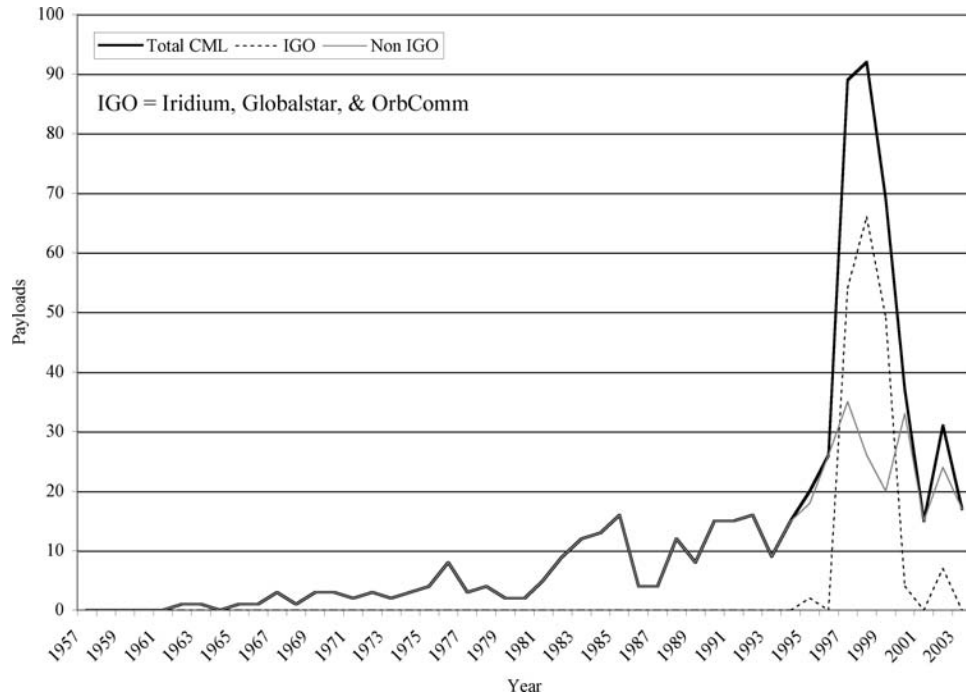

Figure A.11: Commercial Payloads - IGO Breakout

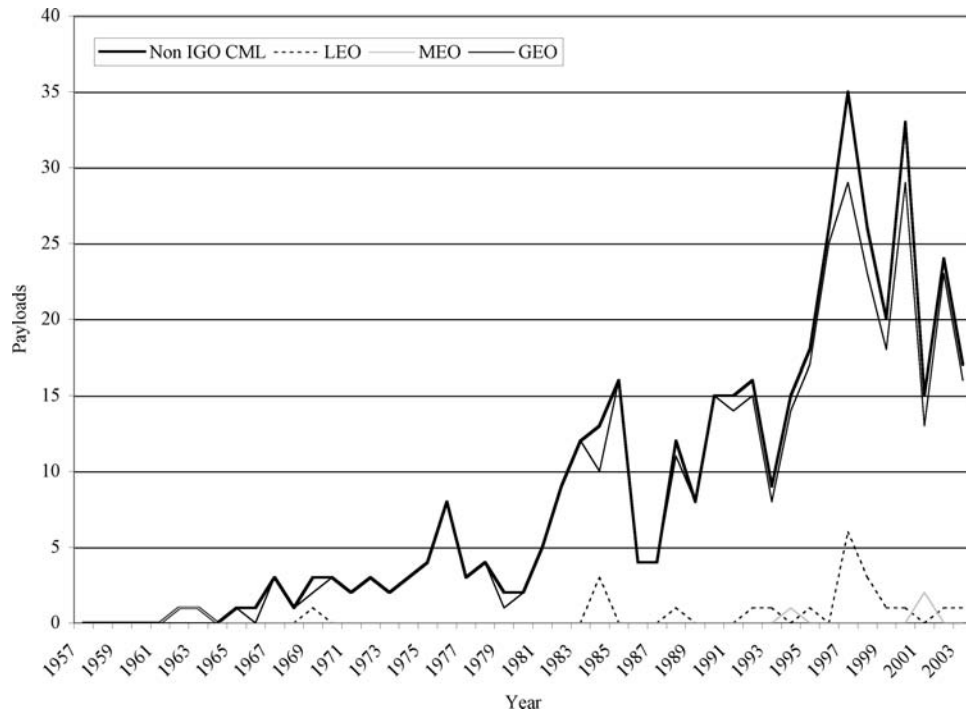

Figure A.12: Commercial Payloads Minus IGOs

The following figures show the population density of various orbital locations.

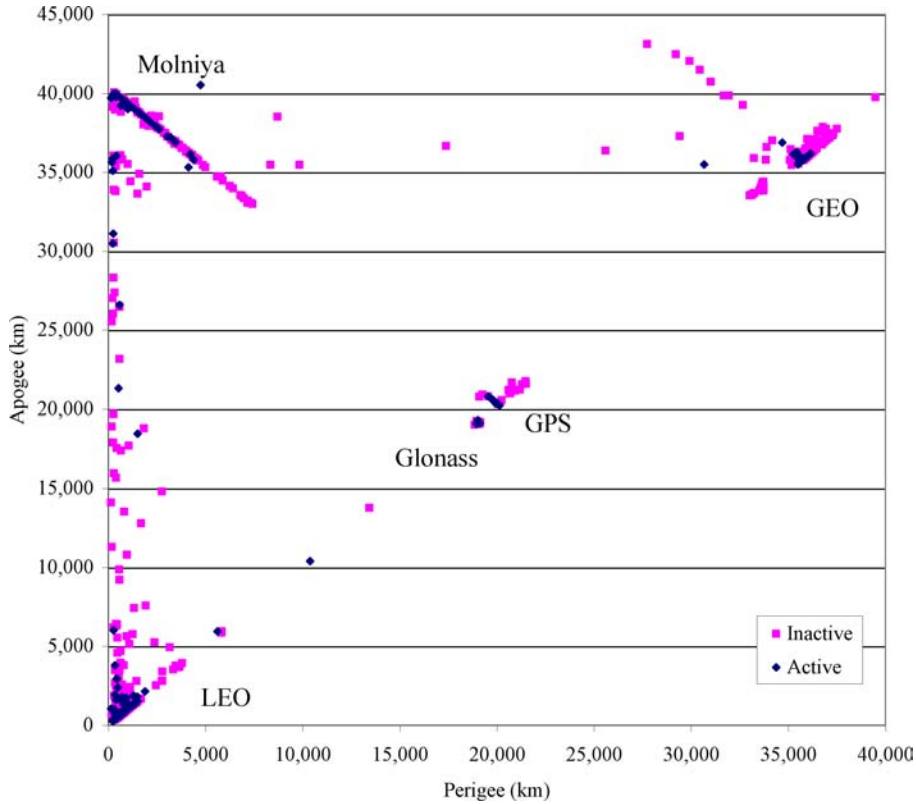

Figure A.13: Orbital Location Of All Spacecraft Near Earth

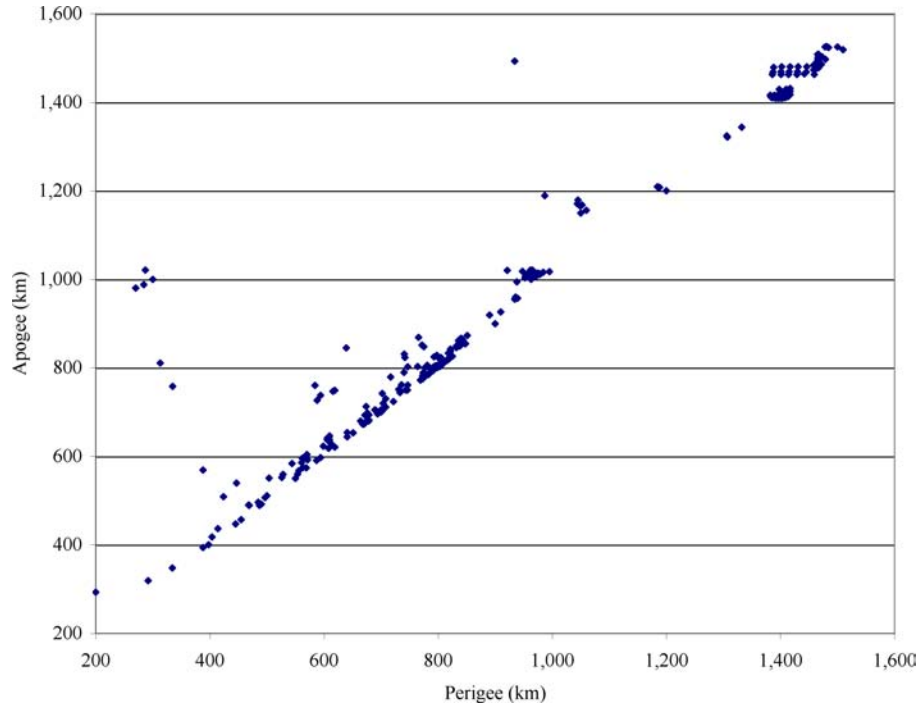

Figure A.14: Orbital Location Of Active Spacecraft In LEO

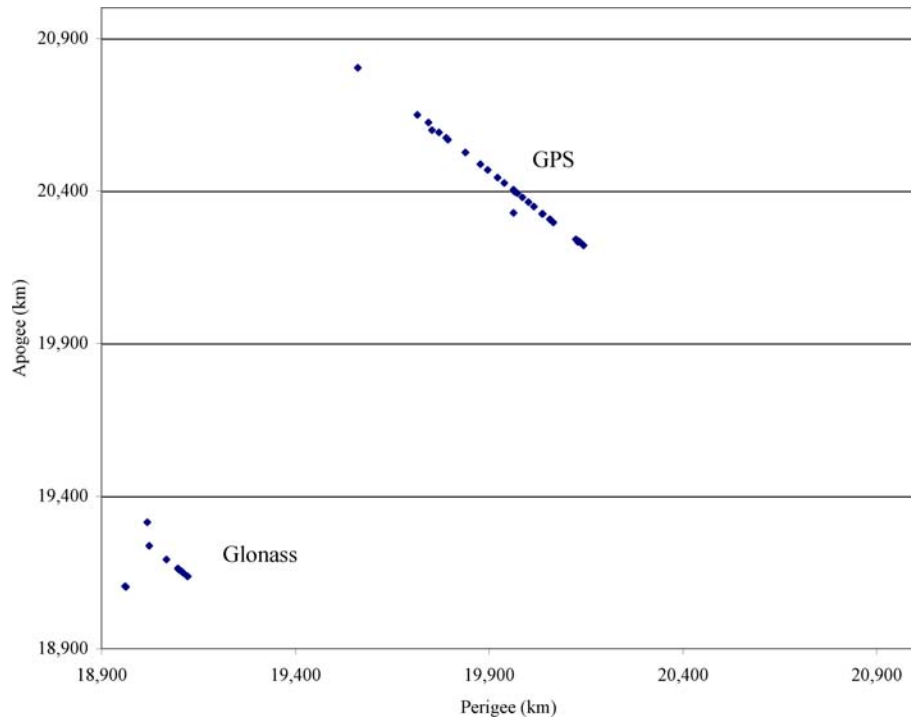

Figure A.15: Orbital Location Of Active Spacecraft In MEO

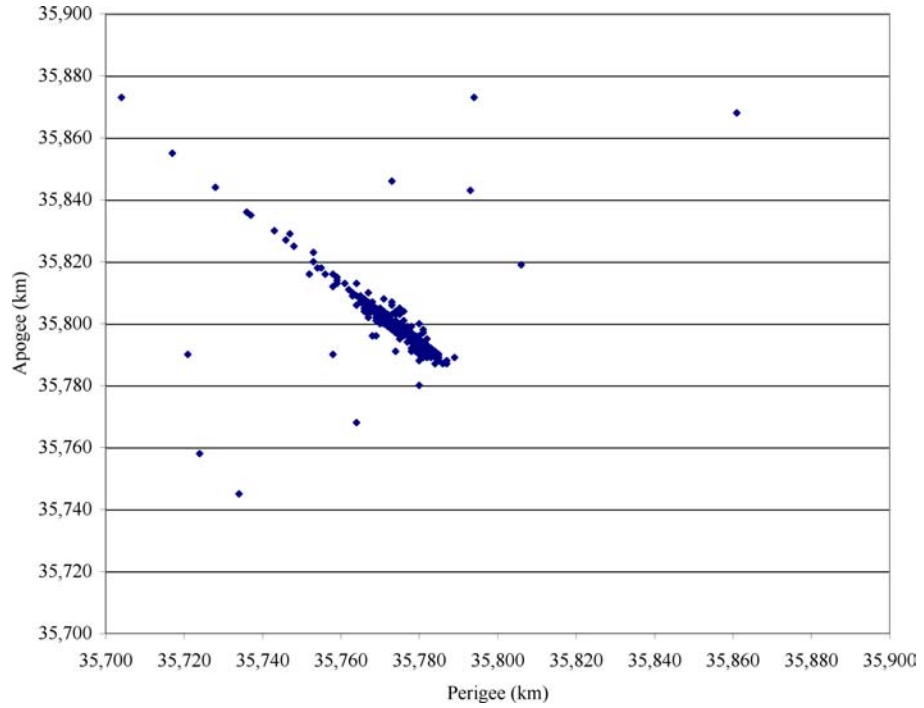

Figure A.16: Orbital Location Of Active Spacecraft In GEO

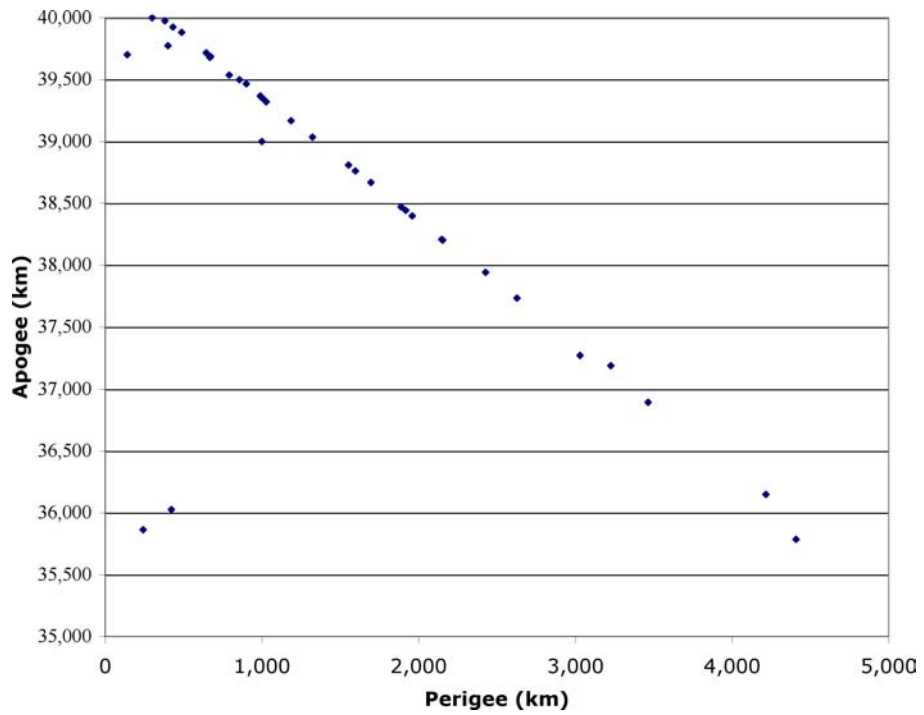

Figure A.17: Orbital Location Of Active Spacecraft In Molniya Orbits

A.3 Geosynchronous Satellite Lifetimes

The following figures show the active (uninclined) life and inclined life for geosynchronous communications satellites that operated in an inclined mode.

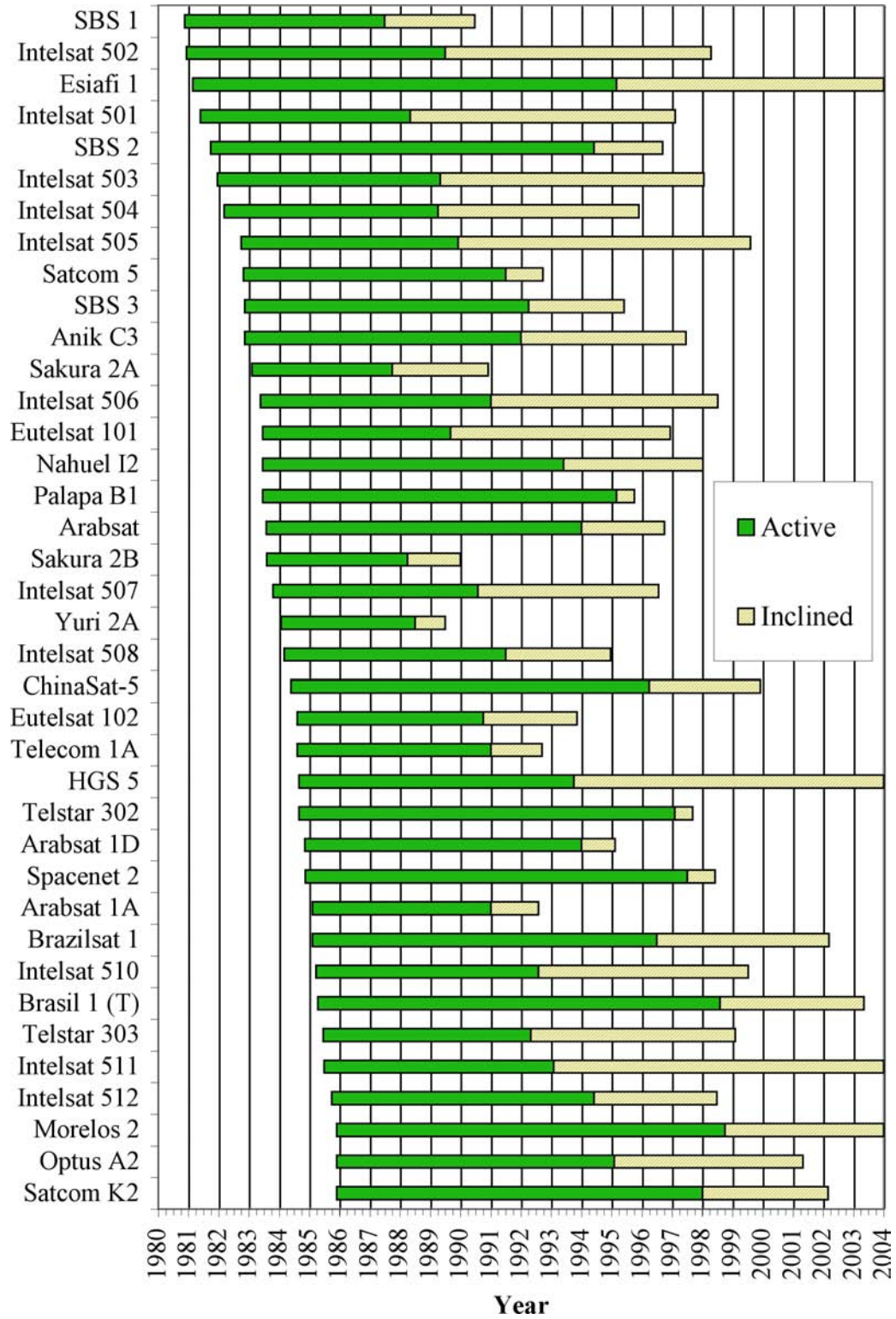

Figure A.18: Lifetimes Of Inclined Commercial Communications Satellites Launched Between 1980 And 1985

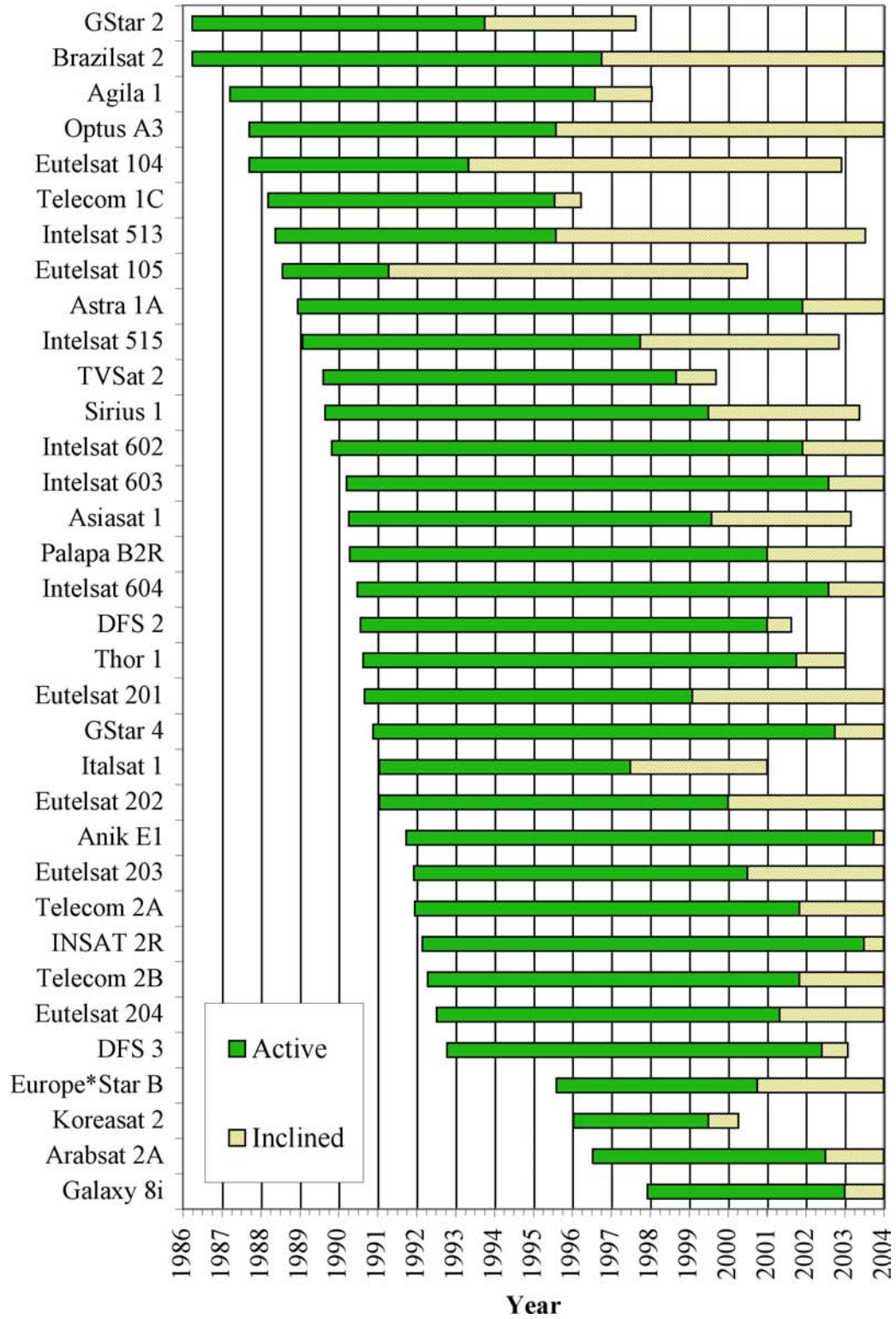

Figure A.19: Lifetimes Of Inclined Commercial Communications Satellites Launched From 1986 Onwards

Appendix B

Geosynchronous Communications Satellite

Revenues

This appendix includes commercial geosynchronous communications satellite revenue. Tables B.1, B.2, and B.3 show the annual revenues for the top 10 satellite operators for the years 2001, 2002, and 2003. Combining the average annual revenue per satellite with the average transponder count per satellite (from Figure 6.2), Table B.4 shows the revenue per transponder and the monthly satellite revenue. These quantities are used elsewhere in this analysis.

Satellite Operator	Country	2001 Revenue (\$M)	Satellites	Revenue Per Sat. (\$M)
SES Global	Luxembourg	1,162.2	29	40
Intelsat	US	1,100.0	22	50
PanAmSat	US	870.1	21	41
Eutelsat	France	593.5	18	33
Loral Space & Comm.	US	388.9	7	56
JSAT	Japan	298.2	8	37
New Skies Satellites	Netherlands	209.0	6	35
Telesat Canada	Canada	201.6	5	40
Space Comm. Corp.	Japan	170.8	4	43
Shin Satellite	Thailand	116.8	3	39
Total		5,111.1	123	41.6

Table B.1: Satellite Revenues For The Top 10 Satellite Operators For 2001 [33]

Satellite Operator	Country	2002 Revenue (\$M)	Satellites	Revenue Per Sat. (\$M)
SES Global	Luxembourg	1,410.0	29	49
Intelsat	U.S.	992.0	26	38
PanAmSat	U.S.	812.3	23	35
Eutelsat	France	690.8	23	30
Loral Space & Comm.	U.S.	391.2	7	56
JSAT	Japan	380.8	8	48
Space Comm. Corp.	Japan	218.7	4	55
Telesat Canada	Canada	207.4	5	41
New Skies Satellites	Netherlands	200.5	6	33
Shin Satellite	Thailand	115.5	3	39
Total		5,419.2	134	40.4

Table B.2: Satellite Revenues For The Top 10 Satellite Operators For 2002 [33]

Satellite Operator	Country	2003 Revenue (\$M)	Satellites	Revenue Per Sat. (\$M)
SES Global	Luxembourg	1,520.0	30	51
Intelsat	US	1,100.0	26	42
Eutelsat	France	954.0	24	40
PanAmSat	US	831.0	21	40
JSAT	Japan	421.0	9	47
Telesat Canada	Canada	266.2	6	44
Space Comm. Corp.	Japan	241.9	5	48
New Skies Satellites	Netherlands	214.9	5	43
Loral Space & Comm.	US	152.4	4	38
Shin Satellite	Thailand	146.5	3	49
Total		5,847.9	133	44.0

Table B.3: Satellite Revenues For The Top 10 Satellite Operators For 2003 [33]

Year	Revenue Per Satellite (\$M)	Transponders Per Satellite	Revenue Per Transponder (\$M)	Revenue Per Satellite Per Month (\$M)
2001	41.6	28.0	1.5	3.5
2002	40.4	30.0	1.3	3.4
2003	44.0	30.8	1.4	3.7

Table B.4: Average Geosynchronous Communications Satellite Revenues

Appendix C

On-Orbit Satellite Failures

This appendix includes spacecraft and anomaly information for reported on-orbit spacecraft failures. Table C.1 lists insurance claims for failure events from 1984 through 2003. Table C.2 lists the estimated value of uninsured losses for spacecraft which experienced mission ending failures. Claims for launch vehicle failures are not included. A number of spacecraft that experienced on-orbit failures were also not included. Omitted types of spacecraft include spacecraft with failures that occurred after the end of their published design life, spacecraft that exploded or inadvertently re-entered, and low mass, low cost experimental spacecraft. Additionally, Russian and Chinese government satellites are not included.

While the first two tables address failures and economic losses, Table C.3 shows additional on-orbit failures. These failures either did not result in loss of vehicle or did not include sufficient financial information to include them in the first two tables.

#	Year	Satellite Name	Cause	Loss Level	Claims (\$M)	Year Total (\$M)
1	1984	Westar 6	Wrong Orbit	Retrieved	105	
2	1984	Palapa B2	Wrong Orbit	Retrieved	56	
3	1984	Intelsat 509	Wrong Orbit	Total	102	263
4	1985	Arabsat 1D	Unknown	Partial	5	
5	1985	Leasat 3	Wrong Orbit	Repaired	20	
6	1985	Leasat 4	Payload	Total	84	109

#	Year	Satellite Name	Cause	Loss Level	Claims (\$M)	Year Total (\$M)
7	1987	TVSat 1	Solar Array	Total	51	51
8	1988	GStar 3	Wrong Orbit	Partial	65	65
9	1989	INSAT 1C	Solar Array	Partial	68	68
10	1993	UFO 1	Wrong Orbit	Total	187.7	188
11	1994	Anik E2	Attitude Control	Partial	4.5	5
12	1995	AMSC 1	Payload	Partial	66	
13	1995	Europe*Star B	Wrong Orbit	Partial	64.4	130
14	1996	Anatolia 1	Attitude Control	Partial	32	
15	1996	Asiasat 2	Antenna	Partial	36	
16	1996	Anik E1	Solar Array	Partial	142.5	
17	1996	Chinasat 7	Wrong Orbit	Total	120	
18	1996	SPOT 3	Attitude Control	Total	13	
19	1996	Hot Bird 2	Fuel Depletion	Partial	19.9	363
20	1997	Telstar 401	Power System	Total	132.5	
21	1997	Intelsat 801	Fuel Depletion	Partial	27	
22	1997	MSAT M1	Payload	Partial	109	
23	1997	JCSat 4	Payload	Partial	21	
24	1997	Tempo 2	Solar Array	Partial	21.4	
25	1997	B-SAT 1A	Payload	Partial	17	
26	1997	Iridium 921	Unknown	Total	18	
27	1997	PAS 6	Solar Array	Partial	37.5	
28	1997	INSAT 2D	Power System	Total	62.1	
29	1997	Hispasat 1A	Payload	Partial	17	
30	1997	HGS-1	Wrong Orbit	Total	215	
31	1997	EarlyBird	Power System	Total	29	707
32	1998	TDF 2	Payload	Partial	2	
33	1998	Iridium 44	Unknown	Total	29.5	
34	1998	Skynet 4D	Payload	Partial	17	
35	1998	UFO 8	Payload	Partial	2	
36	1998	Iridium 914	Unknown	Total	29.5	
37	1998	Iridium 911	Unknown	Total	29.5	
38	1998	Iridium 920	Unknown	Total	29.5	
39	1998	Iridium 48	Unknown	Total	29.5	
40	1998	Iridium 69	Unknown	Total	29.5	
41	1998	Iridium 24	Unknown	Total	29.5	
42	1998	Hispasat 1B	Payload	Partial	2.5	
43	1998	COMETS	Wrong Orbit	Partial	8	
44	1998	Indostar 1	Battery	Partial	25	
45	1998	Iridium 71	Unknown	Total	29.5	
46	1998	Echostar 4	Solar Array	Partial	219.3	

#	Year	Satellite Name	Cause	Loss Level	Claims (\$M)	Year Total (\$M)
47	1998	Galaxy 4	Control Processor	Total	160	
48	1998	Arabsat 2C	Battery	Partial	185	
49	1998	JCSat 1	Fuel Depletion	Partial	25.5	
50	1998	Sirius 2	Power System	Partial	23	
51	1998	Afristar	Payload	Partial	5	
52	1998	PAS 8	Antenna	Partial	68	978
53	1999	INSAT 2E	Payload	Partial	23	
54	1999	Orion 3	Wrong Orbit	Total	265	
55	1999	Galaxy 11	Solar Array	Total	286	574
56	2000	Garuda 1	Antenna	Partial	101.5	
57	2000	INSAT 3B	Unknown	Partial	22	
58	2000	Solidaridad 1	Control Processor	Total	250	
59	2000	PAS 1R	Solar Array	Total	343	
60	2000	Galaxy 7	Control Processor	Total	130	
61	2000	TDRS 8	Payload	Partial	98	945
62	2001	Artemis	Wrong Orbit	Partial	75	
63	2001	PAS 7	Solar Array	Partial	215	
64	2001	Arabsat 3A	Solar Array	Partial	171	461
65	2002	Anik F1	Solar Array	Total	136.2	
66	2002	Astra 1K	Wrong Orbit	Total	217	353
67	2003	Nimiq 2	Power System	Partial	49.8	
68	2003	ADEOS 2	Solar Array	Total	3	53

Table C.1: Insurance Payouts For On-Orbit Satellite Failures

#	Year	Satellite Name	Cause	Loss Level	Value (\$M)	Year Total (\$M)
1	1988	Telecom 1B	Attitude Control	Total	66.2	66.2
2	1993	NOAA 13	Power System	Total	148.4	148.4
3	1995	DFS 1	Unknown	Total	53.1	53.1
4	1996	Navstar 20	Attitude Control	Total	23.0	
5	1996	TDF 1	Attitude Control	Total	1.2	24.3
6	1997	Iridium 27	Unknown	Total	15.0	
7	1997	Navstar 25	Unknown	Total	35.0	
8	1997	ADEOS	Solar array	Total	463.4	
9	1997	STEP M4	Solar array	Total	66.0	579.4
10	1998	Iridium 79	Unknown	Total	16.0	16.0

#	Year	Satellite Name	Cause	Loss Level	Value (\$M)	Year Total (\$M)
11	1999	WIRE	Payload	Total	89.0	
12	1999	DSP 19	Wrong Orbit	Total	625.0	
13	1999	USA 143	Wrong Orbit	Total	1,233.0	1,947.0
14	2000	Globalstar M064	Unknown	Total	34.5	
15	2000	INSAT 2B	Fuel Depletion	Total	20.3	54.8
16	2001	GSAT 1	Fuel Depletion	Total	35.0	
17	2001	BSAT 2B	Wrong Orbit	Total	142.5	177.5
18	2003	Telstar 402R	Power System	Total	59.6	59.6

Table C.2: Estimated Losses For Uninsured On-Orbit Satellite Failures

#	Year	Satellite Name	Cause	Failure Level	Value (\$M)
1	1986	BS-2B	Payload, Comm	Major	
2	1988	San Marco 5	Payload, Sensor	Partial	
3	1988	USA 031	Wrong Orbit	Unknown	
4	1989	HIPPARCOS	Wrong Orbit	Partial	
5	1990	Intelsat 603	Wrong Orbit	Repaired	260
6	1990	BS-3A	Solar array, Deploy	Partial	171
7	1990	DMSP 10	Wrong Orbit	Minor	
8	1990	Superbird A	Fuel Depletion	Lifetime	149
9	1991	CRRES	Battery	Total	
10	1992	SPOT 2	Payload, Data	Partial	
11	1993	Eutelsat 104	Payload, Comm	Partial	75
12	1993	Olympus 1	Fuel Depletion	Lifetime	
13	1994	Anik E1	Attitude, Wheel	Redundancy	174
14	1994	Eutelsat 105	Payload, Comm	Partial	75
15	1994	ETS 6	Wrong Orbit	Major	668
16	1995	NOAA 14	Payload, Sensor	Partial	
17	1995	Skipper	Solar array	Total	
18	1996	Turksat 1C	Unknown	Unknown	157
19	1997	Intelsat 709	Payload, Comm	Partial	208
20	1997	SAX	Attitude, Wheel	Minor	431
21	1997	GOES 8	Attitude, Wheel	Partial	195
22	1997	GOES 10	Solar array	Major	290
23	1997	Agila 2	Wrong Orbit	Minor	290
24	1997	IRS 1D	Wrong Orbit	Major	

#	Year	Satellite Name	Cause	Failure Level	Value (\$M)
25	1998	Spacenet 4	Payload, Comm	Partial	160
26	1998	Equator S	Control Processor	Total	
27	1998	Echostar 3	Power	Partial	202
28	1998	DirecTV 1	Control Processor	Redundancy	247
29	1998	GOES 9	Attitude, Wheel	Major	290
30	1998	Galaxy 7	Control Processor	Redundancy	235
31	1998	PAS 4	Control Processor	Redundancy	198
32	1998	Galaxy 8i	Battery	Minor	250
33	1998	Anatolia 1	Battery	Partial	154
34	1998	TOMS EP	Fuel Depletion	Minor	56
35	1998	HGS-1	Battery	Partial	170
36	1999	GE 3	Attitude, Wheel	Minor	200
37	1999	Solidaridad 1	Control Processor	Redundancy	152
38	1999	ABRIXAS	Battery	Total	38
39	1999	Arabsat 2D	Solar array	Partial	306
40	1999	Telkom 1	Solar array	Minor	165
41	1999	Radarsat	Attitude, Wheel	Redundancy	526
42	2000	CBERS 1	Payload, Sensor	Partial	180
43	2000	NOAA 15	Payload, Sensor	Partial	135
44	2000	CHAMP	Collision	Minor	
45	2000	Galaxy 8i	Propulsion, Xenon	Lifetime	250
46	2000	NOAA 16	Payload, Comm	Partial	
47	2001	EchoStar 6	Propulsion	Partial	250
48	2001	GSAT 1	Wrong Orbit	Lifetime	
49	2001	Galaxy 3R	Control Processor	Redundancy	230
50	2001	Telstar 6	Control Processor	Redundancy	220
51	2001	Echostar 5	Attitude, Wheel	Redundancy	205
52	2001	FUSE 1	Attitude, Wheel	Redundancy	150
53	2001	FUSE 1	Attitude, Wheel	Minor	150
54	2002	TDRS 9	Propulsion	Partial	298
55	2002	Telstar 6	Collision	Minor	220
56	2002	DirecTV 3	Control Processor	Redundancy	275
57	2002	Echostar 5	Solar array	Partial	205
58	2002	EchoStar 6	Solar array	Partial	250
59	2002	Echostar 8	Propulsion	Partial	235
60	2002	DRTS	Wrong Orbit	Minor	311
61	2002	MSG 1	Payload, Comm	Partial	233
62	2003	Thaicom 3	Solar array	Partial	200
63	2003	AMSC 1	Payload, Comm	Partial	262
64	2003	Landsat 7	Payload, Sensor	Major	563

#	Year	Satellite Name	Cause	Failure Level	Value (\$M)
65	2003	ICESat	Payload, Sensor	Minor	202
66	2003	Galaxy 4R	Propulsion, Xenon	Lifetime	240
67	2003	PAS 6B	Propulsion, Xenon	Lifetime	240
68	2003	E-Bird	Antenna	Partial	140
69	2003	Echostar 5	Attitude, Wheel	Partial	205

Table C.3: Additional Significant On-Orbit Satellite Failures

Appendix D

Spacecraft Self-Rescues

This appendix includes altitude and inclination histories for spacecraft that were delivered to incorrect initial orbits. Similar spacecraft launched on analogous launch vehicles are shown for comparison. The horizontal “Days” axis is days since launch. All of these histories generally show that it took days to reach the correct altitude and that the spacecraft generally began inclined operations earlier than a similar spacecraft. Table D.1 shows the spacecraft that recovered and those used for comparison. Orbital data was derived as described in Appendix E.

Satellite Name	Spacecraft Bus	Launch Vehicle	Similar Satellite	Spacecraft Bus	Launch Vehicle
GStar 3	GE-3000	Ariane 3	GSTAR 2	GE-3000	Ariane 3
UFO 1	HS-601	Atlas 1	GOES 8	FS-1300	Atlas 1
Koreasat 1	GE-3000	Delta 7925	Koreasat 2	GE-3000	Delta 7925
Agila 2	FS-1300	Long March CZ-3B	Apstar 2R	FS-1300	Long March CZ-3B
HGS-1	HS-601HP	Proton K/DM-2M	Used Lunar Flyby		
GSAT 1	GSAT	GSLV	GSAT 2	GSAT	GSLV
Artemis	Artemis	Ariane 5	Eurobird	Spacebus 3000B2	Ariane 5
DRTS	DS-2000	H-2A	None Similar		

Table D.1: GEO Bound Spacecraft That Recovered From Incorrect Initial Orbits

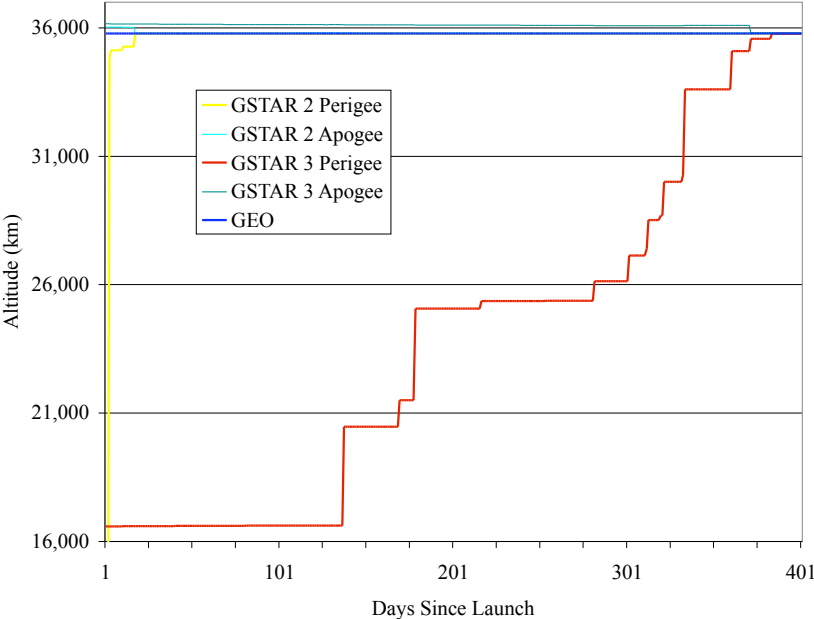

Figure D.1: GSTAR 3 Altitude History

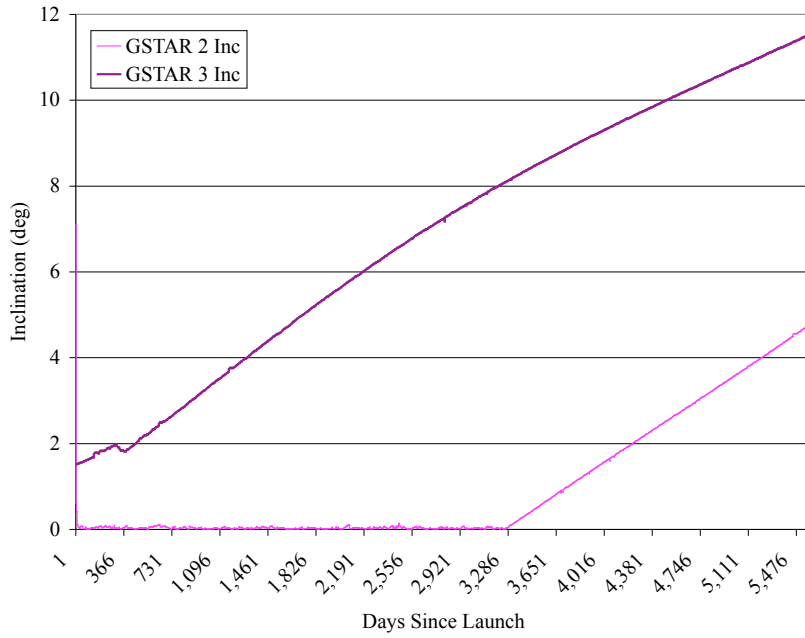

Figure D.2: GSTAR 3 Inclination History

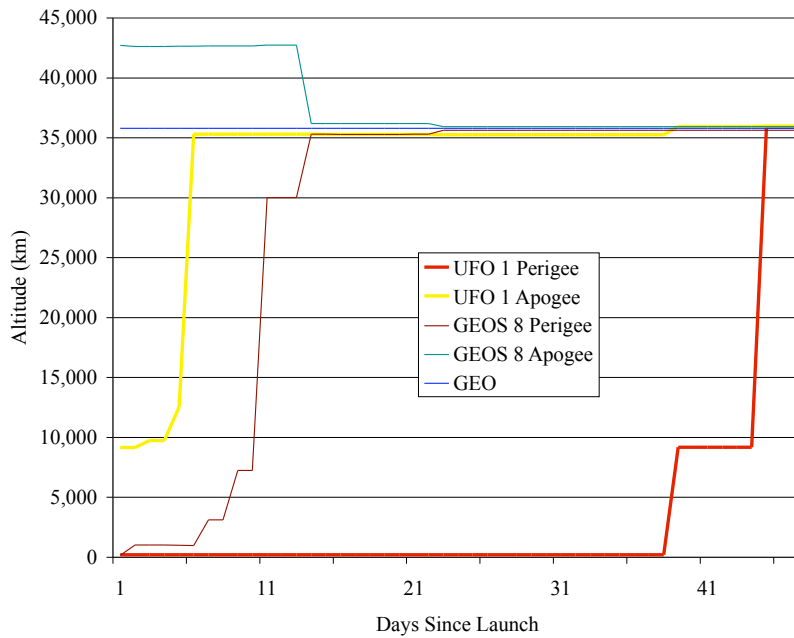

Figure D.3: UFO 1 Altitude History

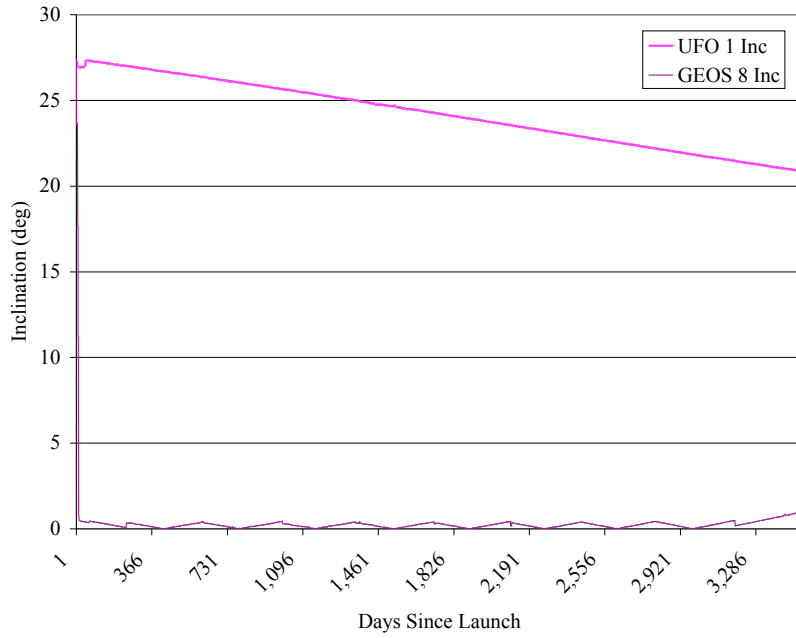

Figure D.4: UFO 1 Inclination History

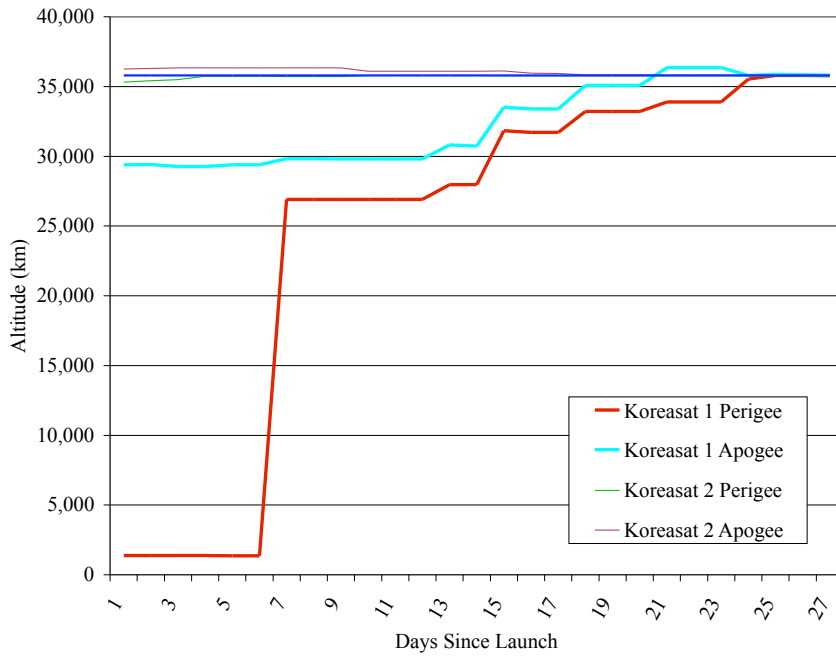

Figure D.5: KoreaSat 1 Altitude History

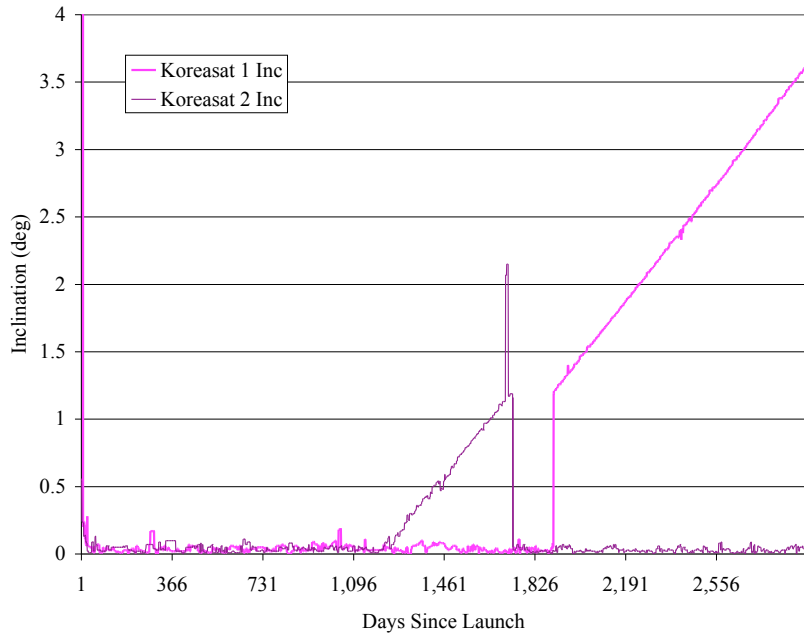

Figure D.6: KoreaSat 1 Inclination History

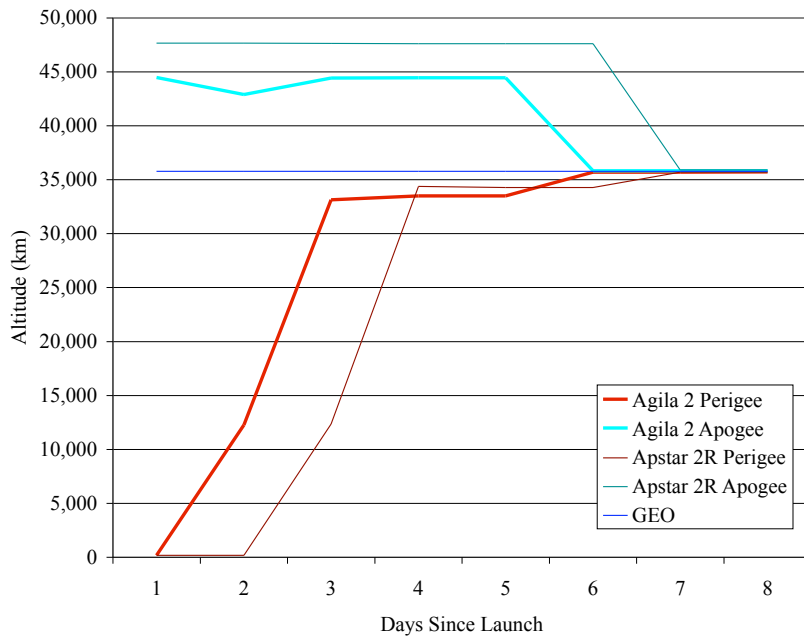

Figure D.7: Agila 2 Altitude History

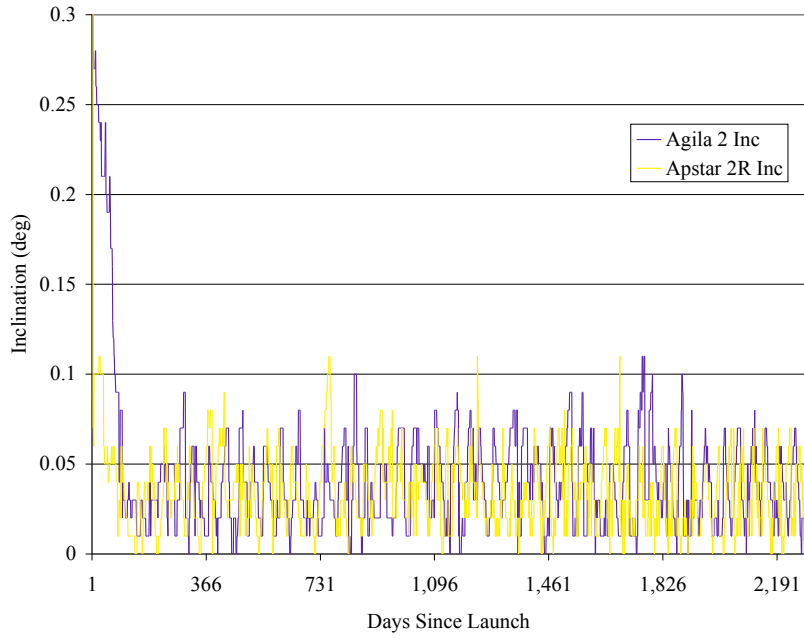

Figure D.8: Agila 2 Inclination History

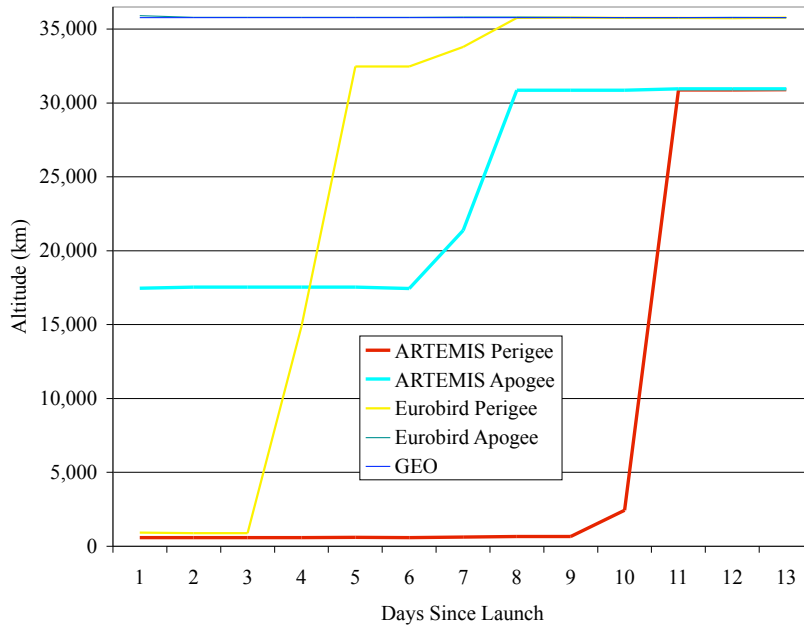

Figure D.9: ARTEMIS Altitude History, First 2 Weeks

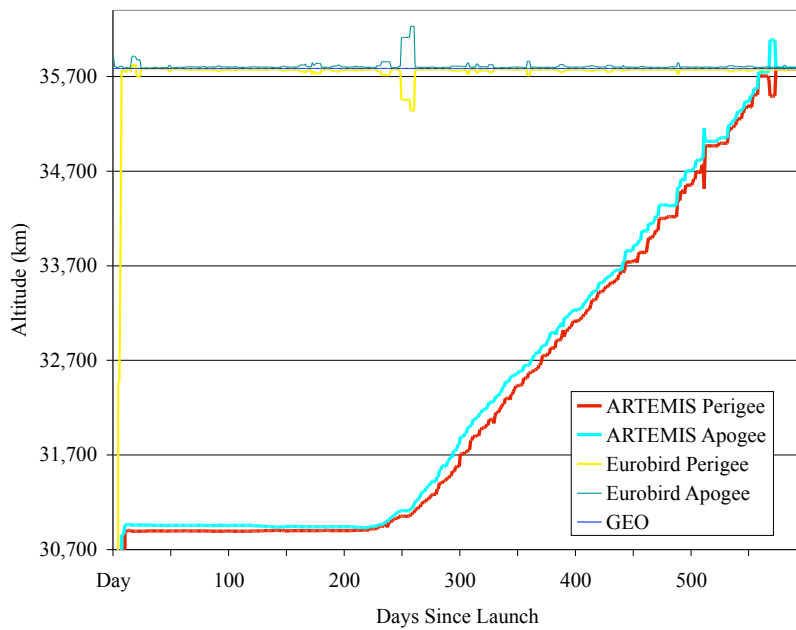

Figure D.10: ARTEMIS Inclination History, First 2 Years

Appendix E

Satellite Orbital Information

For the orbital analysis of this dissertation, information was obtained from the NASA GSFC Orbital Information Group [26]. The information is transmitted as Two Line Element (TLE) sets. The TLE format is shown in Section E.1. This information was filtered, parsed, and converted into a more useable form. It was then analyzed and converted to plots of daily orbital information by satellite. These processes are listed in Section E.2. About 10,000 such plots were generated with an emphasis on geosynchronous satellites.

E.1 NORAD Two-Line Element Set Format

The two line element format is shown below. A character ruler is shown above the two sample lines. In Table E.1 and Table E.2, for signed values, only negative values are flagged with a minus sign, positive values have a space. The first time derivative of the mean motion is in revolution per day-squared. Ballistic coefficient is in meters-squared per kilogram. All orbital elements are referred to the mean equator and equinox of date.

```
0000000001111111111222222222233333333334444444444555555555566666666667  
1234567890123456789012345678901234567890123456789012345678901234567890  
  
1 NNNNNU NNNNAAA NNNNN.NNNNNNNN +.NNNNNNNN +NNNNN-N +NNNNN-N N NNNNN
```

2 NNNNN NNN.NNNN NNN.NNNN NNNNNNN NNN.NNNN NNN.NNNN NN.NNNNNNNNNNNNNNN

Column	Description
1	Line Number of Element Data
03-07	Satellite Number
8	Classification (U=Unclassified)
10-11	International Designator (Last two digits of launch year)
12-14	International Designator (Launch number of the year)
15-17	International Designator (Piece of the launch)
19-20	Epoch Year (Last two digits of year)
21-32	Epoch (Day of the year and fractional portion of the day)
34-43	First Time Derivative of the Mean Motion
45-52	Second Time Derivative of Mean Motion (decimal point assumed)
54-61	BSTAR drag term (decimal point assumed)
63	Ephemeris type
65-68	Element number
69	Checksum (Modulo 10)

Table E.1: NORAD Two-Line Element Set Format [64], [26] - Line 1

Column	Description
1	Line Number of Element Data
03-07	Satellite Number
09-16	Inclination [Degrees]
18-25	Right Ascension of the Ascending Node [Degrees]
27-33	Eccentricity (decimal point assumed)
35-42	Argument of Perigee [Degrees]
44-51	Mean Anomaly [Degrees]
53-63	Mean Motion [Revs per day]
64-68	Revolution number at epoch [Revs]
69	Checksum (Modulo 10)

Table E.2: NORAD Two-Line Element Set Format [64], [26] - Line 2

E.2 Orbital Element Analysis Programs

In order to analyze satellite lifetime maneuvers, a number of programs were written to convert the TLEs into more useable format.

#	Program	Description
1	ParseOIGdata	Convert the TLEs to classical orbital elements (apogee, perigee, etc.).
2	GEOlongs	Analyze the longitude history of geosynchronous satellites.
3	MakePlotSpec	Create the gnuplot plot specification files for plotting the history of satellites' altitude (apogee and perigee), inclination, period, and longitude (of geosynchronous satellites).
4	PlotMania	Create the makefile to allow the plotting of all the satellite orbital elements history files.
5	MakeRelocPlots	Combine the geostationary longitude histories into one LaTeX file.
6	SatSitRepConv	Combine, clean up, and parse the NASA OIG Satellite Situation Reports into an update of the orbital elements for all published satellites.
7	NearGEO	Calculate the closest approach of satellites to the geosynchronous orbit. Results are shown in Section 7.5.2.

Table E.3: Orbital Element Manipulating Programs

E.2.1 ParseOIGdata

The ParseOIGdata program converts the TLEs to classical orbital elements (apogee, perigee, etc.). Includes filtering of bad data, such as data from before the launch date, data points that vary dramatically from the previous and next data points, and other clearly erroneous data.

E.2.1.1 ParseOIGdata Input Sample

ParseOIGdata reads in data files from NASA OIG which includes satellite orbital information the NORAD TLE format.

```

1 11669U 80004 A 80018.29102798 .00005671 -39186-4 +00000-0 0 00026
2 11669 026.3598 327.9713 7322446 181.6344 173.0949 02.27193372000082
1 11669U 80004 A 80018.72488317 .00023323 -39277-4 +99999-4 0 00044
2 11669 026.3339 321.6514 7310914 181.8850 172.0127 02.28381042000009

```

E.2.1.2 ParseOIGdata Output Sample

```

IntID SatName NORAD Date Ecc Apogee Perigee InclIn rtAsc
EpochDayFrac GEOlong GEOnear Data
1980-004A FltSatCom3 11669 1980/01/18 0.7322446 35961.8
166.5 26.36 327.97 0.29102798 999.00 999.00 New 1
1980-004A FltSatCom3 11669 1980/01/19 0.7322446 35961.8
166.5 26.36 327.97 0.29102798 999.00 999.00 Dupe 0

```

ParseOIGdata also produces SatReport.txt and GEOlongs.txt.

E.2.2 GEOlongs

E.2.2.1 GEOlongs Input Sample

GEOlongs uses the output (GEOlongs.txt) from ParseOIGdata as input.

```

NORAD GEOloc Name From To
25546 56.00 Bonum 1 01/01/1958 11/29/2003
25558 -117.00 SAT MEX 5 01/01/1958 03/01/2004
25585 -43.50 PAS 6B 01/01/1958 03/01/2004
25626 -93.00 Telstar 6 01/01/1958 03/01/2004
25630 124.00 JCSat 6 01/01/1958 03/01/2004
25638 25.50 Arabsat 3A 01/01/1958 03/01/2004

```

E.2.2.2 GEOlongs Output Sample

This file shows how long a satellite stayed at a particular longitude.

```

IntID SatName NORAD From To MoveDays FromLong ToLong MoveDegs EOL
1982-097A Intelsat505 13595 1996/06/30 1996/08/02 33 65.5
33.0 32.5 1999/08/04
1982-097A Intelsat505 13595 1996/12/11 1997/03/04 83 33.0
72.0 39.0 1999/08/04

```

E.2.3 MakePlotSpec

The MakePlotSpec program analyzes output (SatReport.txt) from ParseOIGdata, combines manual spec with autogenerated text to make PlotSpec.txt for PlotMania to drive GNUplot.

E.2.3.1 MakePlotSpec Input Sample

Uses SatReport.txt produced by ParseOIGdata.

E.2.3.2 MakePlotSpec Output Sample

Produces PlotSpecs.txt file for PlotMania.

E.2.4 PlotMania

E.2.4.1 PlotMania Input Sample

PlotSpecs.txt is a text file from an Excel list of files for processing. A sample is shown below.

```
gnu file input plot output xrange yrange xlabel ylabel title
label1 label2
Gnu11669Alt.txt 11669.txt TRUE 11669Alt.pdf [ ] [ ] Date
(Launched: 01/18/1980, EOL: 01/01/1991) Altitude (km)
Altitude History of OPS 6393 (FLTSATCOM 3) (11669, 1980-004A)
Apogee Perigee
Gnu11669Inc.txt 11669.txt TRUE 11669Inc.pdf [ ] [ 0.00: 27.00]
Date (Launched: 01/18/1980, EOL: 01/01/1991) Inclination (deg)
Inclination History of OPS 6393 (FLTSATCOM 3) (11669, 1980-004A)
```

E.2.4.2 PlotMania Output Sample

The following charts are produced by gnuplot based on the makefile produced by the previously described files.

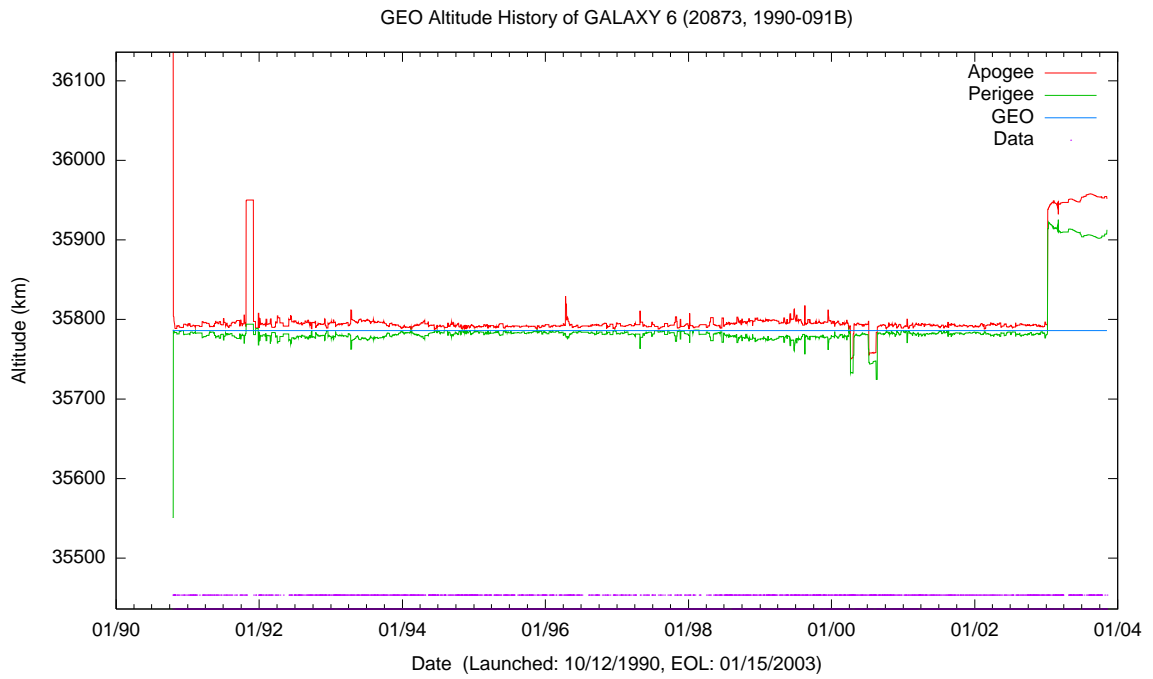

Figure E.1: Sample Satellite Geosynchronous Altitude History Plot

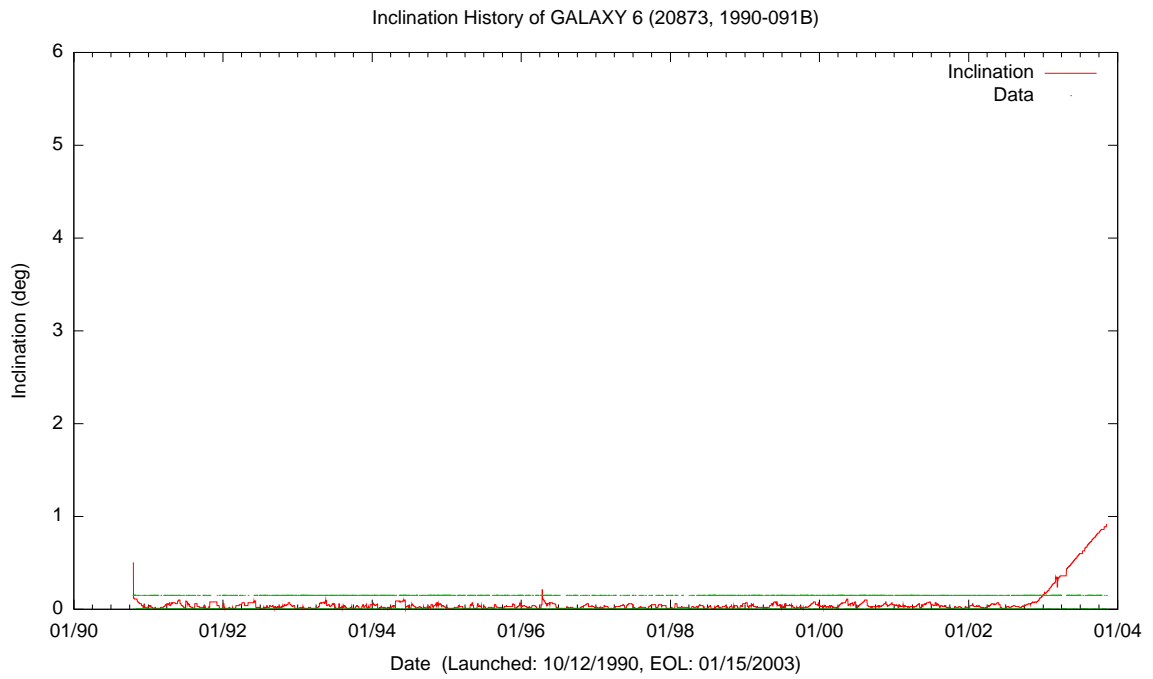

Figure E.2: Sample Satellite Inclination History Plot

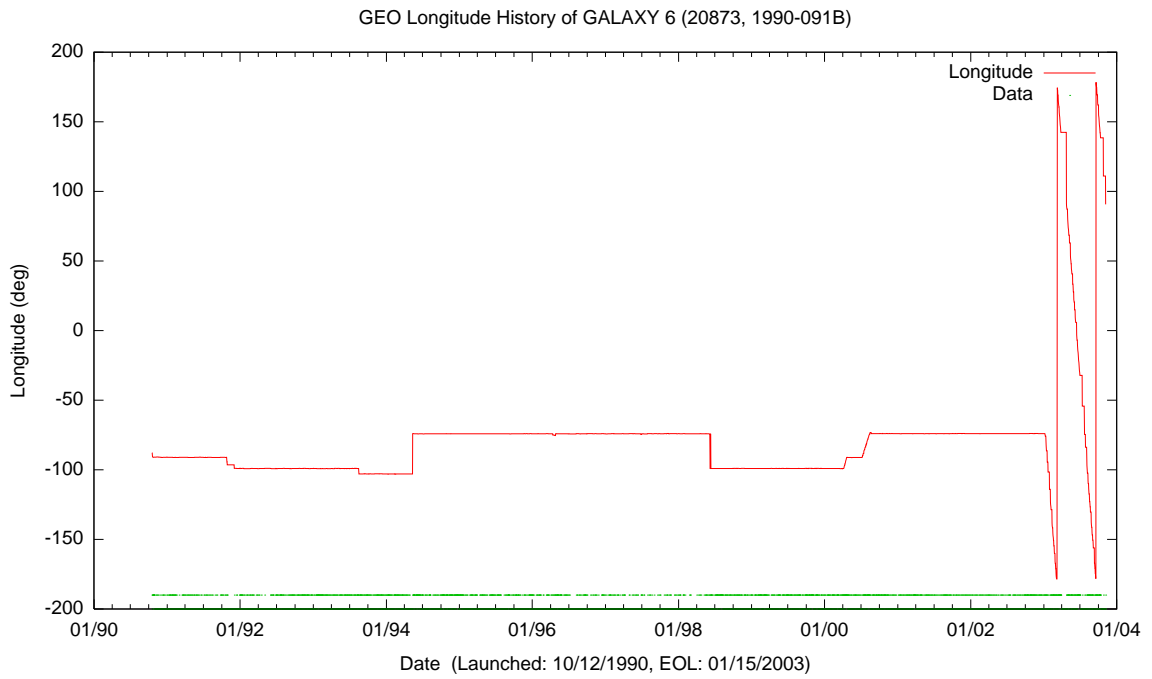

Figure E.3: Sample Satellite Geosynchronous Longitude History Plot

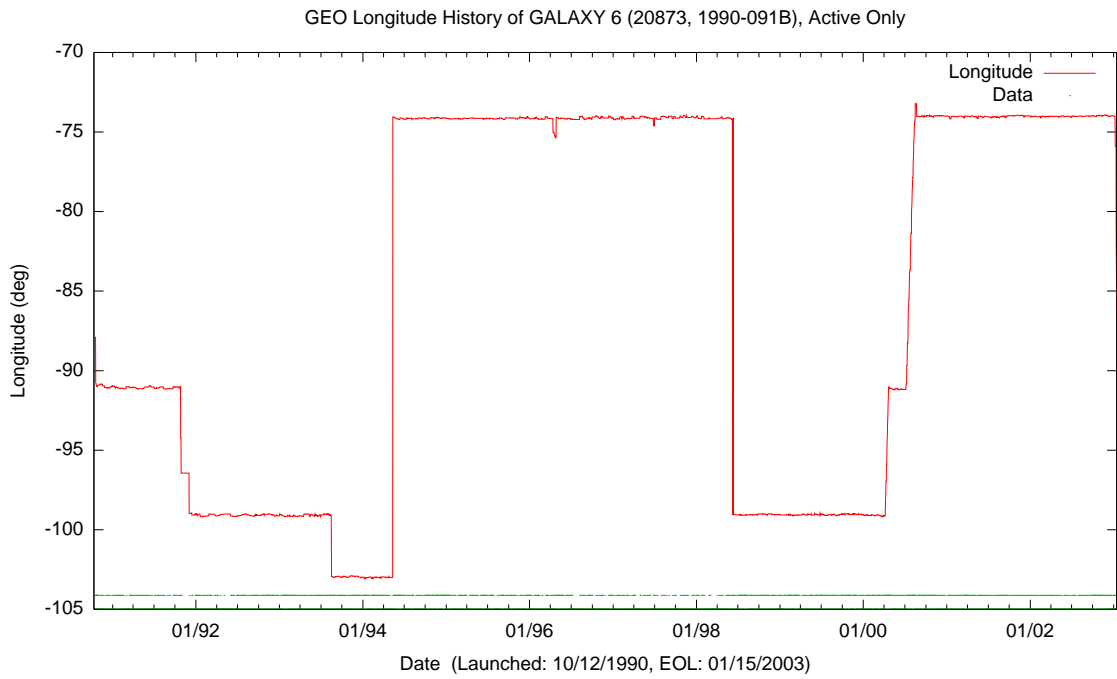

Figure E.4: Sample Satellite Geosynchronous Longitude History Plot, Active Life

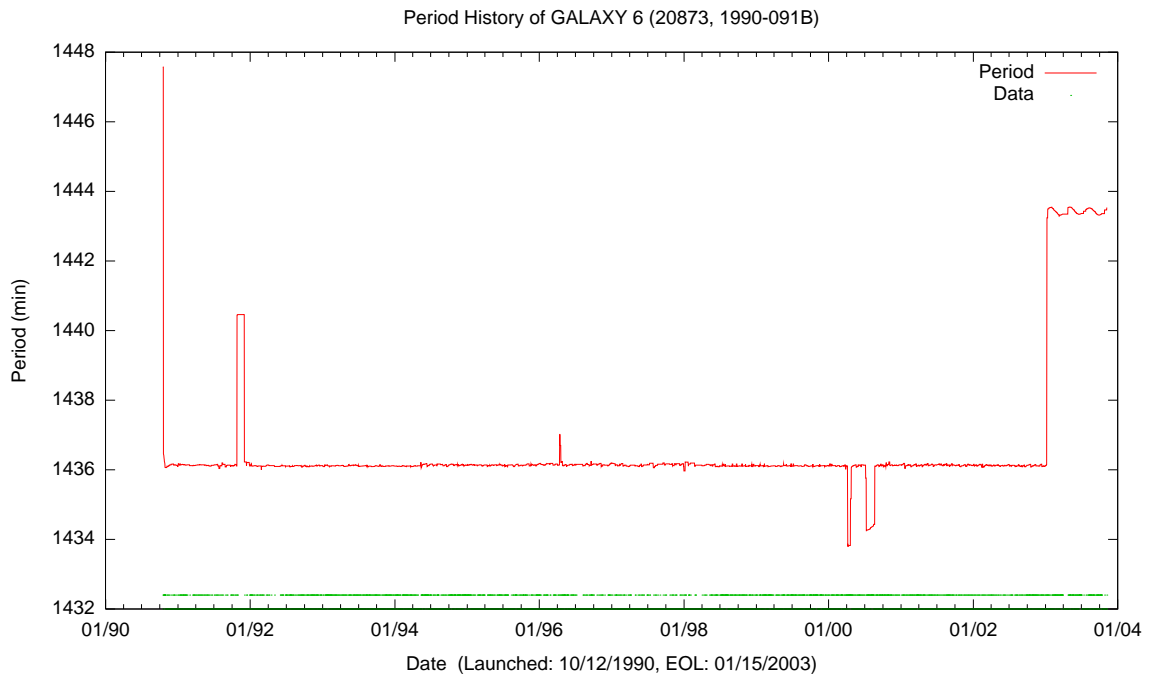

Figure E.5: Sample Satellite Period History Plot

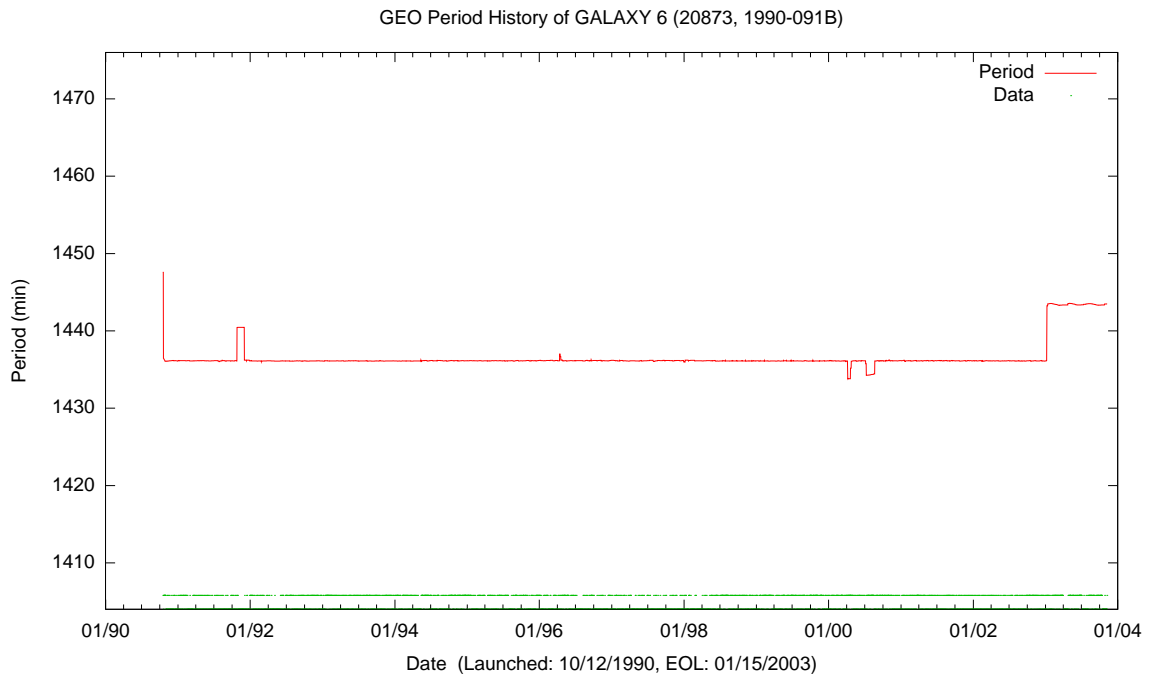

Figure E.6: Sample Satellite Geosynchronous Period History Plot

Appendix F

Launch Costs To GEO

The average cost of launching a kilogram to GEO can be found by consulting the Satellite Information Database. The key fields are estimated launch cost and estimated mass on orbit. In Table F.1 below, the “Satellites” column indicates the number of payloads successfully launched per year with launch and mass information. “Total Mass” is a sum of the mass of all the payloads. “Total Launch Cost” is a sum of the launch costs. Finally, the “GEO Cost” is the cost per kilogram delivered to GEO in units of \$1,000 per kilogram.

Year	Satellites	Total Mass To GEO (kg)	Total Launch Cost (\$M)	GEO Cost (\$K per kg)
1994	19	26,607	1,362	51
1995	23	38,059	1,763	46
1996	27	37,650	1,776	47
1997	32	52,066	2,340	45
1998	27	43,574	1,984	46
1999	20	39,765	1,630	41
2000	35	62,889	2,912	46
2001	16	31,713	1,378	43
2002	25	50,150	2,119	42
2003	14	30,135	1,154	38

Table F.1: GEO Cost Per kg

Appendix G

Inflation Rates

This appendix includes annual inflation rates from the Bureau of Labor Statistics [9]. Reported costs from a particular year can be translated to 2003 costs using the conversion factors Table G.1.

Year	Convert To 2003	Inflation Rate		Year	Convert To 2003	Inflation Rate
2003	1.0000			1991	1.3510	3.0
2002	1.0228	2.3		1990	1.4078	4.2
2001	1.0390	1.6		1989	1.4839	5.4
2000	1.0685	2.8		1988	1.5554	4.8
1999	1.1044	3.4		1987	1.6197	4.1
1998	1.1288	2.2		1986	1.6788	3.6
1997	1.1464	1.6		1985	1.7100	1.9
1996	1.1727	2.3		1984	1.7709	3.6
1995	1.2073	3.0		1983	1.8474	4.3
1994	1.2416	2.8		1982	1.9067	3.2
1993	1.2734	2.6		1981	2.0242	6.2
1992	1.3115	3.0		1980	2.2330	10.3

Table G.1: Annual Inflation Rate [9]

Appendix H

Database Sample Record

This appendix contains a sample data record from the satellite information database in Table H.1 and a sample data record from the on-orbit failure database in Table H.2. Both records reference satellite Astra 1K which is shown in Figure H.1. This spacecraft was intended to be a geosynchronous telecommunications satellite. A launch anomaly left it in a low earth orbit with insufficient fuel to reach its operating orbit. After boosting it to a longer life parking orbit and considering the alternatives, ground controllers eventually commanded it to re-enter after confirming that there was no currently feasible way for it to go into service.



Figure H.1: Astra 1K [36]

#	Field	Value
1	Joint IntID	2002-053A
2	Joint Name	Astra 1K
3	Joint Launch Date	11/25/02
4	Joint NORAD	27557
5	SvcDB	OK
6	GeoDB	GeoComm
7	Launch Mass (kg)	5,250
8	Spacecraft Bus	Spacebus 3000
9	Launch Vehicle	Proton K/DM-3M
10	Payload Year	2002
11	Launch Year	2002
12	Manufacturer	Alcatel Space
13	Program	Astra
14	Block	Europe
15	Mkt	CML
16	Msn1	Com
17	Mission1	GEO Comm
18	Msn2	
19	Mission2	
20	FCO	
21	Actual Duration (days)	0.0
22	Actual Life (yrs)	0.00
23	Design Lifetime (yrs)	15
24	Est Design Lifetime (yrs)	15
25	Est EOL	2002
26	Actual EOL Year	2002
27	Status	Inactive
28	Status Date	11/25/02
29	Decay Date	12/10/02
30	Orbit Note	DECAYED
31	Orbit Loc	DEC
32	Intended Orbit	GEO
33	Orbit	LEO
34	Missed Orbit	TRUE
35	Inc (deg)	51.6
36	Perigee (km)	244
37	Apogee (km)	317
38	Period (min)	90.1
39	Epoch	12/01/02
40	Orbit Info Source	

#	Field	Value
41	e	0.0054816
42	RAAN (deg)	
43	ArgPer (deg)	
44	Date in GEO	
45	GEO Long (deg)	
46	Drift (deg/day)	
47	Human Space Flight	
48	Crew (Up/Dn)	
49	Crew at Launch	
50	Satellite Name	Astra 1K
51	AKA1	
52	AKA2	
53	AKA3	
54	AKA4	
55	Acronym	
56	Operator, Owner, Org.	SES
57	Country	Luxembourg
58	Original Country	
59	Launch Site	Baikonur
60	Upper Stage	
61	Xenon Propulsion	
62	Dimensions	
63	Est In Orbit Mass (kg)	3,150
64	Est Dry Mass (kg)	2,205
65	Est Life Fuel Mass (kg)	945
66	In Orbit Mass (kg)	
67	Dry Mass (kg)	
68	Fuel Mass (kg)	
69	Payload Mass (kg)	
70	DC Power (W)	13,000
71	DC Power BOL (W)	
72	DC Power EOL (W)	
73	Payload Power (W)	
74	Solar Array Config	
75	Stabilization	3-axis
76	Stabilization Note	
77	SS/L Prog Cost (\$M) FY95	

#	Field	Value
78	SS/L Prog Cost (\$M) FY02	
79	SS/L Prog Cost (\$M)	
80	Est Sat Cost (\$M)	150
81	Est Launch Cost (\$M)	82.5
82	Total Cost (\$M)	
83	Sat Cost (\$M)	
84	Launch Cost (\$M)	82.5
85	Insurance Cost (\$M)	47
86	Insured Amount (\$M)	290
87	Low Insurance Pay- out (\$M)	275
88	High Insurance Pay- out (\$M)	290
89	Total Xpndr	54
90	C-band Xpndr	
91	C-band BW	
92	Ka-band Xpndr	2
93	Ka-band BW	
94	Ku-band Xpndr	52
95	Ku-band BW	
96	L-band Xpndr	
97	L-band BW	
98	S-band Xpndr	
99	S-band BW	
100	X-band Xpndr	
101	X-band BW	
102	UHF-band Xpndr	
103	UHF-band BW	
104	Coverage	
105	Sources	3
106	Source ASTX	Astx
107	Source AWST	
108	Source Celestrak	Celestrak
109	Source CLS2	
110	Source Hibbard	
111	Source Hughes	
112	Source Intelsat	
113	Source Isak	
114	Source JSR	

#	Field	Value
115	Source JSR2	
116	Source JSR3	
117	Source MSL	
118	Source NSSDC	
119	Source NSSDC2	
120	Source PAS	
121	Source SatToday	
122	Source STK	
123	Source TSE	TSE
124	Source SatND	
125	Payload Launch ID	2002-053
126	Deployed by / Released	
127	Firsts / Lasts	
128	Short Mission Description	Luxembourg geostationary communications spacecraft was prematurely commanded to separate from upper stage, resulting in the spacecraft orbiting at a very low orbit.
129	Long Mission Description	ASTRA 1K was to be a European (Luxembourg-based) geostationary communications spacecraft. It was launched by a Proton-K rocket from Baikonur at 23:04 UT on 2002 November 25. The 5.0-ton, 13-kW spacecraft was reported to be the most massive of civilian communications spacecraft, with 52 Ku-band and two Ka-band transponders to cover 1,100 channels. It was prematurely commanded to separate from the DM-3 booster, resulting in a very low orbit. In an effort to prevent imminent re-entry, the spacecraft was raised to a circular orbit at an altitude of 290 km. Three options were considered: (a) to force its re-entry over the Pacific Ocean; (b) to retrieve it by a US shuttle; or, (c) to use up all the fuel onboard the satellite to move it to a geostationary orbit at 19.2 degrees East longitude. It was commanded to re-enter.
130	Anomalies	The Block DM upper stage failed to ignite for its second burn, leaving the satellite in parking orbit.
131	More Failure Info	
132	FailDB	FOI
133	Fail Type	
134	BRS Notes	
135	NukeDB	
136	Nuclear Status	

#	Field	Value
137	Geo Xp / Kg	0.010
138	Geo Xp Yr / Kg	0.154
139	OIG TLEs 02/19/04	0

Table H.1: Satellite Database Sample Record

#	Field	Value
1	Failure ID	2002-053A#1
2	#	1
3	Joint IntID	2002-053A
4	Vers	DB
5	Joint Name	Astra 1K
6	Joint Launch Date	11/25/02
7	Joint NORAD	27557
8	FailDB	OK
9	Design Lifetime (yrs)	15
10	Failure Year	2002
11	Prefail Life (days)	0
12	Prefail Life (yrs)	0.0
13	Actual Life (yrs)	
14	Beyond EOL (yrs)	
15	Era	BOL
16	Status	Inactive
17	Status Date	11/25/02
18	Simple Failure Level	Total
19	Failure Level	Total
20	Failure Type	Wrong Orbit
21	Brief Failure Description	Upper stage failure
22	Failure Description	The Block DM upper stage failed to ignite for its second burn, leaving the satellite in parking orbit.
23	Failure Date	11/25/02
24	Failure Source	L/V
25	Standard Brief Failure Description	
26	salvage note	Commanded Reentry
27	Could Be Serviced	Yes
28	Generic Service Required	Boost
29	Probable State	Stable

#	Field	Value
30	Service Required	Boost to GEO
31	Total Cost (\$M)	
32	Sat Cost (\$M)	
33	Launch Cost (\$M)	
34	Low Insurance Claim (\$M)	277.5
35	High Insurance Claim (\$M)	
36	Source ASTX	ASTX
37	Source AWST2	
38	Source Dowa	
39	Source GTF	
40	Source INTEC	
41	Source Isak2	
42	Source ISIR	
43	Source SatND	
44	Source Stock	
45	Source Waltz	
46	Source MSL	
47	Source STK	
48	Source TSE	TSE
49	Source JSR	
50	Source NSSDC	
51	Source Morgan	

Table H.2: On-Orbit Failure Database Sample Record

BIBLIOGRAPHY

- [1] Satellite Servicing Mission Preliminary Cost Estimation Model. Technical Report NASA-CR-171978, SAIC, Jan 1987.
- [2] Satellite Servicing: A NASA Report To Congress. Technical Report NASA-TM-107816, NASA HQ, Mar 1988.
- [3] Satellite Servicing Economic Study. Technical Report NASA-CR-184113, Space Systems / Loral, Dec 1990.
- [4] Spacecraft Modular Architecture Design (SMARD). Technical report, Naval Research Laboratory, Oct 1996.
- [5] Space Insurance: The Claim Amount Per Loss. http://www.dowafire.co.jp/space/index_e.html, Jun 1998. Dowa Insurance.
- [6] Mission and Spacecraft Library. <http://leonardo.jpl.nasa.gov/msl/home.html>, Dec 2000. NASA JPL.
- [7] Satellite Today. <http://www.satellitetoday.com/>, Dec 2000.
- [8] Boeing Products. <http://www.hughespace.com/products.html>, Apr 2001. Boeing.
- [9] Bureau of Labor Statistics. <http://stats.bls.gov/>, May 2001.
- [10] Intelsat. <http://www.intelsat.com/satellites.asp>, Apr 2001.

- [11] NSSDC Master Catalog. <http://nssdc.gsfc.nasa.gov/nmc/sc-query.html>, Jan 2001. National Space Science Data Center.
- [12] PanAmSat Corporation. <http://www.panamsat.com/>, Apr 2001.
- [13] Spacecraft Digest. <http://www.stk.com/resources/scdigest-spacecraftdigest.cfm>, Feb 2001. Analytical Graphics Incorporated.
- [14] The Satellite Encyclopedia Online. <http://www.tbs-satellite.com/tse/online/index.shtml>, Feb 2001. Tag's Broadcasting Service.
- [15] NAFCOM. <http://nafcom.saic.com/>, Aug 2002. SAIC.
- [16] AFRL's Space Vehicles Directorate. <http://www.vs.afrl.af.mil/>, Jun 2004.
- [17] Arianespace. http://www.arianespace.com/site/launcher-future_sub_index.html, Nov 2004.
- [18] Autonomous Proximity Microsatellites. <http://www.afrlhorizons.com/Briefs-Dec03/VS0304.html>, Jun 2004. AFRL.
- [19] Camera Sees Giant Hughes Satellite Deploying Its Wings. <http://spaceflightnow.com/news/0002/24hs702arrays/>, Nov 2004.
- [20] CSA - Image Gallery. <http://www.space.gc.ca>, May 2004. Canadian Space Agency.
- [21] Delta Expendable Launch Vehicles. <http://www.boeing.com/defense-space-space/delta/flash.html>, Jul 2004.
- [22] DLR - ROboter Technology EXperiment ROTEX. <http://www.robotic.dlr.de/TELEROBOTICS/rotex.html>, Jun 2004. DLR.
- [23] Human Space Flight Gallery. <http://spaceflight.nasa.gov/gallery/index.html>, May 2004. NASA.

- [24] ILS: International Launch Services. <http://www.ilslaunch.com/missionplanner/>, May 2004.
- [25] Mini AERCam - Home. <http://aercam.nasa.gov/>, May 2004. NASA JSC.
- [26] NASA/GSFC Orbital Data. <http://oig1.gsfc.nasa.gov/>, Jun 2004.
- [27] Orbital Recovery Corp. <http://www.orbitalrecovery.com/>, Jun 2004.
- [28] Orbital Sciences Corporation. <http://www.orbital.com>, May 2004.
- [29] Parametric Cost Estimating Handbook. <http://www.jsc.nasa.gov/bu2-/PCEHTML/pceh.htm>, Nov 2004.
- [30] Satellite News Digest. <http://www.sat-index.com/>, May 2004.
- [31] Shuttle Program. <http://science.ksc.nasa.gov/mirrors/images/html-/shuttle.htm>, Jun 2004. NASA KSC.
- [32] Space Exploration Technologies Corporation. <http://www.spacex.com>, May 2004.
- [33] Space News. <http://www.space.com/spacenews/>, Jun 2004.
- [34] Space Systems Laboratory. <http://ssl.umd.edu>, May 2004. University of Maryland.
- [35] Spacecraft Vehicle Level Cost Model. <http://www.jsc.nasa.gov/bu2-/SVLCM.html>, Nov 2004.
- [36] Spacetoday.net. <http://www.spacetoday.net>, Jun 2004.
- [37] Tactical Technology Office. <http://www.darpa.mil/tto/>, May 2004. DARPA.

- [38] Teleoperation Experiments of Engineering Test Satellite VII (ETS-VII) Mounted Robotic Arm. <http://www.space.mech.tohoku.ac.jp/research/etsvii-etsvii-e.html>, May 2004. JAXA.
- [39] B. N. Agrawal. *Design of Geosynchronous Spacecraft*. Prentice-Hall, 1986.
- [40] D. L. Akin. Dexterous Robotics Technologies For On-Orbit Servicing. Technical report, UMD Space Systems Lab, 2003.
- [41] D. L. Akin and G. G. Gefke. The Ranger Robotics Program. Technical report, UMD Space Systems Lab, Apr 2002.
- [42] Rob Ambrose. Robonaut. http://vesuvius.jsc.nasa.gov/er_er/html/robonaut-robonaut.html, Jun 2000. JSC Robotics.
- [43] Benjamin S. Blanchard. *System Engineering Management*. Wiley-Interscience, 1991.
- [44] A. B. Bosse et al. SUMO: Spacecraft For The Universal Modification Of Orbits. Technical report, NRL, Apr 2004.
- [45] S. P. Bradley et al. *Applied Mathematical Programming*. Addison-Wesley, 1977.
- [46] Michael A. Collins Jr., A. D. Aldrich, and Glynn S. Lunney. STS 41-G National Space Transportation Systems Program Mission Report. Technical Report NASA-TM-105473, NASA JSC, Nov 1984.
- [47] Anthony R. Curtis, editor. *Space Satellite Handbook*. Gulf Publishing Company, third edition, 1994.
- [48] Richard de Neufville. *Applied Systems Analysis*. McGraw-Hill, 1990.
- [49] Peter de Selding. Space News June 28, 2004. http://www.space.com/spacenews-businessmonday_040628.html, Jul 2004.

- [50] Michael A. Delpinto. Assessing Potential Benefits For Service/Repair And Retrieval Of Satellites: A Pilot Decision Analysis. Master's thesis, Air Force Institute of Technology, Dec 1988.
- [51] J. H. Saleh E. Lamassoure and D. E. Hastings. Space Systems Flexibility Provided by On-Orbit Servicing: Part II. In *AIAA Space 2001 Conference and Exposition 28-30 August 2001, Albuquerque, NM*, number AIAA 2001-4631, Aug 2001.
- [52] Ted G. Eschenbach. *Engineering Economy*. Irwin, 1995.
- [53] Yohsuke Fukushima et al. Capture And Berthing Experiment Of A Massive Object Using ETS-VII's Space Robot World First On-Orbit Satellite Capture Experiment By Space Robot System. Technical report, NASDA, 2000.
- [54] Gardell Gefke. Ranger Telerobotic Shuttle Experiment. <http://rtsx.ssl.umd.edu/>, May 2001. UMD SSL.
- [55] T. Hanada and T. Yasaka. Orbital Debris Environment Model in the Geosynchronous Region. Jan 2002.
- [56] Gloria W. Heath, editor. *Space Safety And Rescue 1995*, volume 93. Univelt, 1997.
- [57] R. L. Hibbard. Satellite On-Orbit Refueling: A Cost Effectiveness Analysis. Master's thesis, Naval Postgraduate School, Sep 1996.
- [58] G. Hirzinger et al. Preparing a New Generation of Space Robots. <http://esapub.esrin.esa.it/pff/pffv7n2/hirzv7n2.htm>, Jun 2004.
- [59] S. J. Isakowitz. *International Reference Guide To Space Launch Systems, 3rd Ed.* AIAA, third edition, Sep 1999.

- [60] D. E. Hastings J. H. Saleh and D. J. Newman. Spacecraft Design Lifetime. Mar 2002.
- [61] D. E. Hastings J. H. Saleh, E. Lamassoure and D. J. Newman. Flexibility and the Value of On-Orbit Servicing: A New Customer-Centric Perspective. In *Core Technologies for Space Systems Conference 28-30 November 2001, Colorado Springs CO*, Nov 2001.
- [62] E. Lamassoure J. H. Saleh and D. E. Hastings. Space Systems Flexibility Provided by On-Orbit Servicing: Part I. In *AIAA Space 2001 Conference and Exposition 28-30 August 2001, Albuquerque, NM*, number AIAA 2001-4673, Aug 2001.
- [63] T. Kasai, M. Oda, and T. Suzuki. Results Of The ETS-7 Mission - Rendezvous Docking And Space Robotics Experiments. In *ISAIRAS99, Proceedings of the International Symposium on Artificial Intelligence, Robotics and Automation in Space*, page 15, Jun 1999.
- [64] T.S. Kelso. Celestrak WWW. <http://celestrak.com/>, Dec 2000.
- [65] A. S. Kiersarsky. Effects Of In-Orbit Servicing On Nimbus Configuration. Technical Report NASA-CR-106547, Bellcomm, Inc., Jul 1969.
- [66] Gunter Krebs. Gunter's Space Page. <http://www.skyrocket.de/space/space.html>, Jun 2004.
- [67] E. Lamassoure and D. Hastings. A Framework to Account for Flexibility in Modeling the Value of On-Orbit Servicing for Space Systems. Master's thesis, MIT, Jun 2001.
- [68] N.Y. Lao and Others. Small Satellite Cost Model, Version 98 Intro. Technical report, Aerospace Corp, Jun 1998.

- [69] G. Leisman and A. Wallen. Design And Analysis Of On-Orbit Servicing Architectures For The Global Position System. Master's thesis, Air Force Institute of Technology, Mar 1999.
- [70] G. Leisman, A. Wallen, S. Kramer, and W. Murdock. Analysis And Preliminary Design Of On-Orbit Servicing Architectures For The GPS Constellation. Technical Report AIAA Paper 99-4425, AIAA, 1999.
- [71] G.M. Levin and Others. The NASA/INTEC Satellite Salvage/Repair Study. In *3rd European In-Orbit Operations Technology Symposium, Noordwijk*, Jun 1993.
- [72] W. P. Manger and H. O. Curtis. Simplified Parametric Cost Trade-Offs In Satellite System Design. In *International Astronautical Federation, International Astronautical Congress, 32nd, Rome, Italy, Sept. 6-12, 1981*, number IAF Paper 81-224 in International Astronautical Federation, Sep 1981.
- [73] Jonathan McDowell. Jonathan's Space Report. <http://hea-www.harvard.edu/QEDT/jcm/space/jsr/jsr.html>, Feb 2001.
- [74] M. E. McVey. Valuation Techniques for Complex Space Systems: An Analysis of a Potential Satellite Servicing Market. Master's thesis, Jun 2002.
- [75] M. E. McVey and J. Warmkessl. Valuation Techniques for Complex Space Systems: An Analysis of a Potential Satellite Servicing Market. Technical Report AIAA 2003-1331, MIT, 2003.
- [76] Walter L. Morgan. Comm sats quality problems need more than just buzz words. <http://communications-center.com/pdf/q399.pdf>, 1999.
- [77] Lauri K. Newman. Economic Feasibility Of Satellite Refueling Using A Low-Cost Servicer. Master's thesis, University Of Maryland at College Park, 1994.

- [78] David M. North, editor. *Aerospace Source Book*, volume 152. McGraw-Hill, Jan 2000.
- [79] James Obert. Consultant Report: Soyuz Landing Safety. <http://www.jamesoberg.com/soyuz.html>, Nov 2004.
- [80] M. Oda. System Engineering Approach In Designing The Teleoperation System Of The ETS-VII Robot Experiment Satellite. In *ICRA97*, Apr 1997.
- [81] J.C. Parrish. The Ranger Telerobotic Shuttle Experiment: An On-Orbit Satellite Servicer. In *ISAIRAS99, Proceedings of the International Symposium on Artificial Intelligence, Robotics and Automation in Space*, page 225, Jun 1999.
- [82] C. Reynerson. Spacecraft Modular Architecture Design For On-Orbit Servicing. In *Space Technology Conference and Exposition, Albuquerque, NM*, number AIAA-99-4473 in American Institute of Aeronautics and Astronautics. AIAA, AIAA, Sep 1999.
- [83] C. M. Reynerson. Spacecraft Servicing - First Order Model for Feasibility and Cost Effectiveness. In *Core Technologies for Space Systems Conference 28-30 November 2001, Colorado Springs CO*, number AIAA 2001-4732, Nov 2001.
- [84] R. C. Reynolds and J. S. Greenberg. *A Parametric Approach To Evaluating Cost-Effectiveness Of Debris Mitigation Measures*, pages 403–422. Number IAA-95-6.6.02 in International Academy of Astronautics. Univelt, 1995.
- [85] Keith A. Ryden and David G. Fearn. *End-Of-Life Disposal Of Satellites Using Electric Propulsion: An Aid To Mitigation Of The Space Debris Problem*, pages 371–387. Number IAA-95-6.5.04 in International Academy of Astronautics. Univelt, 1995.

- [86] W. Scheider. Apparatus For Attaching Two Spacecraft Under Remote Control. *NASA Tech Reports*, Aug 1999.
- [87] W. Scheider. Apparatus For Attaching Two Spacecraft Under Remote Control. Technical report, NASA JSC, Aug 1999.
- [88] D. B. Spencer et al. Orbital Debris Hazard Assessment Methodologies for Satellite Constellations. Jan 2001.
- [89] David B. Spencer. Space Debris And Its Effects On Space Operations. *Aerospace America*, pages 38–42, Feb 1997.
- [90] B. Stockwell. *Space Insurance*, pages 340–343. Press Syndicate of the University of Cambridge, 1990.
- [91] B. Sullivan et al. On-Orbit Industrial Services - University of Maryland Business Plan Competition. Technical report, SSL, Jan 2003.
- [92] James H. Suttle. A Life Cycle Cost Effectiveness Comparison Of Satellite Replacement And Space Repair Strategies. Technical Report AIAA Paper 89-5068, AIAA, Jul 1989.
- [93] A. E. Turner. Cost-Effective Spacecraft Dependent Upon Frequent Non-Intrusive Servicing. In *AIAA Space 2001 Conference and Exposition 28-30 August 2001, Albuquerque, NM*, number AIAA 2001-4554, Aug 2001.
- [94] Andrew E. Turner. Orbit Dynamics for Cost-Effective Spacecraft Dependent on Frequent Non-Intrusive Servicing. Jul 2001.
- [95] Andrew E. Turner. Development of Geosynchronous Satellite Servicing. In *Core Technologies for Space Systems Conference 28-30 November 2001, Colorado Springs CO*, Nov 2001.

- [96] Andrew E. Turner. Orbital Fueling Benefits For Geosynchronous Spacecraft. Technical Report AIAA 2002-2006, SS/L, May 2002.
- [97] Andrew E. Turner. Use Of A Staging Orbit For Geosynchronous Orbit-Raising Involving Servicing. Technical Report AIAA 2002-4904, SS/L, Aug 2002.
- [98] Unattributed. Group Task Force On Satellite Rescue And Repair. Technical Report NASA-TM-108713, NASA HQ, Sep 1992.
- [99] Unattributed. Major Space Losses and Insurance Claims. *International Space Industry Report*, 3(6):19, Dec 1999.
- [100] J. A. Vandekerckhove. Satellite Servicing In Orbit. *ESA Journal*, 5(3):165–185, Jan 1981.
- [101] J. A. Vandekerckhove. Satellite Refueling In Orbit. In *Communications Satellite Systems Conference, 9th, San Diego, CA, March 7-11, 1982*, number AIAA Paper 82-0514 in American Institute of Aeronautics and Astronautics, Mar 1982.
- [102] J. A. Vandekerckhove. A Model For The Comparison, For Cost-Effectiveness, Of Expendable, Reusable And Serviceable Spacecraft. In *IAF, International Astronautical Congress, 36th, Stockholm, Sweden, Oct. 7-12, 1985*, number IAF Paper 85-425 in International Astronautical Federation, Oct 1985.
- [103] Mark Wade. Encyclopedia Astronautica . <http://www.astronautix.com>, May 2004.
- [104] Myles Walton and Daniel Hastings. Application of Uncertainty Analysis to Architecture Selection of Satellite Systems. Technical report, 2004.
- [105] Donald M. Waltz. *On-Orbit Servicing Of Space Systems*. Krieger Publishing Company, 1993.

- [106] James R. Wertz and Wiley J. Larson. *Space Mission Analysis And Design*. Microcosm, 1999.
- [107] Bradley Wong. The Aerospace Corporation Launch Log Report. <http://ax.laafb.af.mil/gowerj/ssed/>, Mar 2001.
- [108] T. Yasaka and Y. Yoshitsugu. Geostationary Service Vehicle (GSV) For Economical On-Orbit Servicing. In *IAF, International Astronautical Congress, 40th, Malaga, Spain, Oct. 7-13, 1989*, number IAF Paper 89-696 in International Astronautical Federation, Oct 1989.
- [109] Tetsuo Yasaka. Geostationary Service Vehicle Concept And Application, Feb 1989.
- [110] Tetsuo Yasaka. GSV - A New Opportunity For On-Orbit Service Technology. In *Space utilization and applications in the Pacific; Proceedings of the 3rd Pacific Basin International Symposium on Advances in Space Science Technology and its Applications, Los Angeles, CA, Nov. 6-8, 1989*, number AAS Paper 89-651 in Advances in Astronautical Sciences, pages 495–505, Nov 1989.
- [111] Tetsuo Yasaka. Tumble Orbit Transfer Of Spent Satellites. *Journal of Spacecraft and Rockets*, 27(3):348–350, May 1990.
- [112] Tetsuo Yasaka, Yoshitsugu Yasui, and Shun-Ichi Oda. On Orbit Servicing And Its Implications On Future Geostationary Activity Growth. In *I-SAIRAS '90; Proceedings of the International Symposium on Artificial Intelligence, Robotics and Automation in Space, Kobe, Japan, Nov. 18-20, 1990*, pages 325–328, Jan 1990.