

## ABSTRACT

Title of dissertation: ESSAYS ON FOREIGN EXCHANGE  
RESERVE ACCUMULATION

Youngjin Yun, Doctor of Philosophy, 2017

Dissertation directed by: Professor Şebnem Kalemli-Özcan  
Department of Economics

I study the effect of foreign exchange reserve accumulation on domestic financial markets. Central banks sterilize reserve purchases through sales and issuance of domestic debts. Therefore, reserves are funded by central banks' domestic borrowing. Public borrowing affects credit allocation in domestic financial markets. First, it reduces total credit to private sector. Second, as creditors adjust their portfolio after taking over public debts, different debtors are differently affected according to their risk-return characteristics.

The first chapter studies how sterilized accumulation of reserves affects bank lending. I develop a model of imperfect capital mobility where reserve is accumulated by the central bank's borrowing. The model analytically shows that reserve accumulation crowds out bank loans. I examine monthly balance sheets of all Korean banks from September 2003 to August 2008 and find that bank lending declined after reserve accumulation. The crowding-out coefficient, defined as the ratio of reduced lending to accumulated reserves, is estimated to be 0.5. I further investigate whether reserve accumulation leads banks to cut lending by examining bank char-

acteristics that can make some banks more responsive to reserve accumulation than others. I find that strong banks (highly capitalized, large size banks with abundant core deposits), which can expand lending easily, cut loans more. Also, foreign bank branches, which specialize more in security trading than loan provision, cut loans more aggressively compared to domestic banks.

The second chapter continues by examining the effect of reserve accumulation on firms' financial constraints. I build a model of reserve accumulation with heterogeneous firms and show differential crowding out effects of reserve accumulation on different-sized firms. The negative effect from reserve accumulation is larger on large firms that issue debt securities more substitutable with risk-free, low-return central bank papers. Using firm level data from Korea during 1999 to 2007, I measure firm financial constraints using investment-cash sensitivity regressions. I find that large firms become more financially constrained after reserve accumulation, whereas small firms are not affected. The large firms' investment loss in the sample amounts to 0.5% of GDP per every 1% of GDP reserve accumulation.

ESSAYS ON FOREIGN EXCHANGE RESERVE  
ACCUMULATION

by

Youngjin Yun

Dissertation submitted to the Faculty of the Graduate School of the  
University of Maryland, College Park in partial fulfillment  
of the requirements for the degree of  
Doctor of Philosophy  
2017

Advisory Committee:  
Professor Şebnem Kalemli-Özcan, Chair  
Professor S. Borağan Aruoba  
Professor Felipe Saffie  
Professor John Shea  
Professor Phillip Swagel

© Copyright by  
Youngjin Yun  
2017

## Preface

Foreign exchange reserve management is an important policy instrument to open economies. Countries can alleviate the negative impact of volatile international capital flows by managing international reserves properly. Reserve accumulation can bound exchange rate appreciation, thereby backing export-oriented growth. Decumulation of reserves can slow down the pace of currency depreciation and help preventing a sharper external adjustment. FX reserve management policy is used popularly and heavily in many countries. Indeed, the literature revealed that international reserve flow is one of the most important determinant of a country's equilibrium capital flow.

Foreign exchange reserve came into the focus of research interest years before the global financial crisis. Following up the capital account opening of the 1990s, many countries in the world increased international reserve holdings. Especially, east Asian countries started aggressive saving in the wake of the Asian crisis of the late 1990s. Reserve accumulation accounted for a large share of the global imbalance developed over 2000-2008. As such, many discussions were made on the origin of the “global saving glut”. A group of researchers paid attention to the precautionary motive against sudden stops ([Durdu et al. \(2009\)](#), [Obstfeld et al. \(2010\)](#), [Jeanne and Ranciere \(2011\)](#)), while there are others finding out merchantilist motives ([Dooley et al. \(2004\)](#), [Rodrik \(2008\)](#), [Korinek and Serven \(2010\)](#)). Despite the attention, however, the domestic consequence of reserve accumulation is not well investigated as most researches focus on the benefits of reserves.

No lunch is free in economics. There are costs for holding reserves. The most obvious one is the carry cost of reserves. Holding international reserves in the asset side, central banks or governments have corresponding debt. The return differential of the two items generates fiscal losses. Or, the economy as a whole, including private sector, the return on reserve assets can be compared with the country's external borrowing rate, since the reserve could have been used to pay back external debt. The cost of reserve holding measured by this static comparison of return rates often ranges around 1% of GDP for heavy accumulators. ([Rodrik \(2006\)](#), [Adler and Mano \(2016\)](#)) The carry cost of reserves, however, does not consider the distortion created in the course of stockpiling foreign exchange reserve. What happens in the domestic financial market when reserves are being accumulated remain unexplained in the literature.

Reserves are funded by domestic borrowing. It is documented that reserve accumulation is almost fully sterilized through issuance and sales of domestic debts by central banks. Most countries use interest rate targets for their monetary policy implementation. This means that any purchase of foreign exchange would be automatically sterilized not to make interest rate deviate from the target. In this sense, sterilized reserve accumulation is a swap of foreign exchange with public debt. The domestic borrowing of monetary authority can alter credit allocation in domestic financial markets and influence bank loans and firm investment. A monetary authority must be a major player in a local financial market and thus, its action has significant impact. Policy makers need to be well informed about the unintended impact of their decision.

This dissertation investigates the distortion of reserve accumulation in two aspects, the effects on bank loans and firm investments. Chapter 1 examines the impact on bank loans and Chapter 2 studies the firm financial constraints and investments. In both chapters, I begin with a simple theoretical model to characterize the mechanism. Unlike most existing models on FX reserves, I model reserves as being accumulated by the central bank's domestic borrowing. By introducing imperfection in international capital market, I show that reserve accumulation crowds out bank loans and firm investment, and that heterogeneity in banks and firms plays an important role.

In each chapter, I investigate data from Korea for the period before the Great Recession. Chapter 1 examines the bank level data and Chapter 2 investigates the firm level data. Korea is one of the most typical reserve accumulating countries and suitable for this study. I find that reserve accumulation is associated with reduction in bank loans and firm investment. Furthermore, I find that the effects vary according to bank and firm heterogeneity.

## Dedication

To Eunjung Lee,

my beloved wife,

whose love and care

made it possible for me to finish this work



## Acknowledgments

Getting through the dissertation process, I received tremendous help from many people. I need to thank for their support and encouragement.

I would first like to thank my advisors and committee members. I thank Professor Şebnem Kalemli-Özcan, the chair of my committee. I was deeply inspired by her passion, not to mention the knowledge and know-how to address research questions. She was always available to talk and listen despite daunting schedules. I am blessed to be her student.

I thank Professor John Shea for reading many versions of my humble drafts in detail and giving me the most important feedbacks. As a graduate student, I had the luxury of having a critical reader like him and I am truly grateful for that.

I learned the importance of intuition and insight in economic research from Professor Felipe Saffie and I thank him for his help and support. Professor S. Borağan Aruoba gave me important questions on my research and he kindly agreed to serve as one of my committee member. Professor Phillip Swagel generously accepted my invitation to the doctoral committee as the dean's representative. I very much appreciate their help.

I wish to acknowledge the financial support from the Bank of Korea. I was very fortunate for working at the bank to incubate questions on international capital flows and desire for a doctoral degree. Eventually, I was provided with the financial means to pursue my dream. And reserve accumulation, a policy that deals with capital flows, became my thesis topic.

I am indebted forever to my wife Eunjung Lee for her love and endurance throughout the last five years. I thank my parents for their unfailing belief in me. And I am grateful also to my parents in law for their help and support for my family. Lastly, I thank Ina and Inho, my daughter and son, for their presence itself has been a source of enormous encouragement and motivation to me.

## Table of Contents

|   |      |
|---|------|
| Preface   | ii   |
| Dedication  | v    |
| Acknowledgements                                  | vi   |
| Table of Contents                                 | viii |
| List of Tables                                    | x    |
| List of Figures                                   | xi   |
| List of Abbreviations                             | xii  |
| 1 Reserve Accumulation and Bank Lending           | 1    |
| 1.1 Introduction                                  | 1    |
| 1.2 Related Literature                            | 5    |
| 1.3 The Model                                     | 7    |
| 1.3.1 Households                                  | 8    |
| 1.3.2 Firms                                       | 9    |
| 1.3.3 Banks                                       | 11   |
| 1.3.4 Foreign Investors                           | 11   |
| 1.3.5 Central Bank                                | 14   |
| 1.3.6 Equilibrium                                 | 15   |
| 1.3.7 Effect of Reserve Accumulation              | 16   |
| 1.4 Empirical Investigation                       | 20   |
| 1.4.1 Data  | 20   |
| 1.4.2 Sample Period                               | 23   |
| 1.4.3 Bank Lending after Reserve Accumulation     | 25   |
| 1.4.4 Cross-sectional Differences in Bank Lending | 29   |
| 1.4.5 Robustness Check                            | 33   |
| 1.5 Conclusion                                    | 35   |

|       |  |    |
|-------|--|----|
| 2     | Reserve Accumulation and Firm Investment | 42 |
| 2.1   | Introduction                             | 42 |
| 2.2   | Theoretical Approach                     | 48 |
| 2.2.1 | Households                               | 50 |
| 2.2.2 | Non-tradable Good Firms                  | 51 |
| 2.2.3 | Tradable Good Firms                      | 51 |
| 2.2.4 | Domestic Financial Intermediary          | 54 |
| 2.2.5 | FX Intermediaries                        | 56 |
| 2.2.6 | Central Bank                             | 57 |
| 2.2.7 | Equilibrium                              | 58 |
| 2.2.8 | Effect of Reserve Accumulation           | 60 |
| 2.3   | Empirical Evidence                       | 67 |
| 2.3.1 | Testing Framework                        | 67 |
| 2.3.2 | Regression Equation                      | 70 |
| 2.3.3 | Data                                     | 73 |
| 2.3.4 | Measuring Firm Financial Constraints     | 76 |
| 2.3.5 | Main Results                             | 78 |
| 2.3.6 | Counterfactual Exercise                  | 81 |
| 2.3.7 | Dynamic Model                            | 82 |
| 2.3.8 | Effect on Firm Interest Rate             | 85 |
| 2.4   | Conclusion                               | 87 |
| A     | Appendix for Chapter 1                   | 88 |
| A.1   | Existence and Uniqueness of Equilibrium  | 88 |
| A.2   | Proofs of Propositions                   | 90 |
| A.3   | Numerical Illustration of the Model      | 95 |
| B     | Appendix for Chapter 2                   | 97 |
| B.1   | Sample Selection                         | 97 |
|       | Bibliography                             | 99 |

## List of Tables

|      |   |    |
|------|---|----|
| 1.1  | Bank Asset Composition  | 21 |
| 1.2  | Summary Statistics  | 22 |
| 1.3  | Macro Aggregates over the Sample Period                       | 24 |
| 1.4  | Response of Bank Lending to Reserve Accumulation              | 28 |
| 1.5  | Cross-sectional Determinants of Bank Lending                  | 31 |
| 1.6  | Different Regressand Form and Sample Period                   | 37 |
| 1.7  | KRW Loans   | 38 |
| 1.8  | Different Bank Categories                                     | 39 |
| 1.9  | Elasticity Regressions  | 40 |
| 1.10 | Placebo Test  | 41 |
| 2.1  | Central Bank Balance Sheet                                    | 43 |
| 2.2  | Parameters and Initial Conditions                             | 61 |
| 2.3  | Variable Definitions  | 75 |
| 2.4  | Effect of Financial Openness and Firm Size                    | 77 |
| 2.5  | Effects of Reserve Accumulation on Firm Financial Constraints | 79 |
| 2.6  | Dynamic Model Estimation                                      | 84 |
| 2.7  | Interest Rate Regression                                      | 86 |
| A.1  | Parameterization  | 95 |
| B.1  | Industry Classification                                       | 98 |

## List of Figures

|      |   |    |
|------|---|----|
| 1.1  | Reserve to GDP Ratio Changes between 2000 - 2015 . . . . .            | 2  |
| 1.2  | Monthly Reserve Accumulation over the Sample Period . . . . .         | 23 |
| 2.1  | International Reserves and Investment in Selected Asian Countries . . | 44 |
| 2.2  | Bank Credit Allocation . . . . .                                      | 46 |
| 2.3  | Model Outline . . . . .   | 49 |
| 2.4  | Exchange Rate and Trade Balance . . . . .                             | 62 |
| 2.5  | Ricardian Equivalence Failure . . . . .                               | 63 |
| 2.6  | Equilibrium Interest Rates . . . . .                                  | 64 |
| 2.7  | Crowded-out Capital . . . . .   | 65 |
| 2.8  | Reserve Accumulation of Korea . . . . .                               | 73 |
| 2.9  | Investment of Large Firms and Small Firms . . . . .                   | 76 |
| 2.10 | Counterfactual Gross Fixed Capital Formation . . . . .                | 82 |
| A.1  | Numerical Illustrations . . . . .                                     | 96 |

## List of Abbreviations

|      |   |
|------|---|
| BOK  | the Bank Of Korea                         |
| BOP  | Balance Of Payments                       |
| CD   | Certificate of Deposits                   |
| CIP  | Covered Interest rate Parity              |
| CP   | Commercial Paper                          |
| CRS  | Constant Returns to Scale                 |
| DRS  | Decreasing Returns to Scale               |
| FX   | Foreign Exchange                          |
| GDP  | Gross Domestic Product                    |
| GMM  | Generalized Method of Moment              |
| IMF  | International Monetary Fund               |
| KRW  | Korean Won                                |
| KSIC | Korean Standard Industrial Classification |
| MPK  | Marginal Product of Capital               |
| OLS  | Ordinary Least Squares                    |
| ROE  | Return On Equity                          |
| ROW  | Rest Of the World                         |
| SME  | Small and Medium sized Enterprise         |
| SOE  | Small Open Economy                        |
| UIP  | Uncovered Interest rate Parity            |
| USD  | United States Dollar                      |
| VAR  | Vector Autoregression                     |
| VMPL | Value of Marginal Product of Labor        |
| WLS  | Weighted Least Squares                    |

## Chapter 1: Reserve Accumulation and Bank Lending

### 1.1 Introduction

International reserve management is an important policy tool for small open economies facing volatile capital flows. Following the capital account opening of the 1990s, many countries, both in emerging and advanced economies, accumulated considerable amounts of reserves. Figure 1.1 compares the reserve to GDP ratio of 2000 with that of 2015. The ratio increased significantly in most countries over the last 15 years. The average increase of the ratio in the 33 countries is 9.7% points.

This chapter examines the effects of reserve accumulation on bank lending. Despite the popularity of reserve policy, the existing literature on foreign exchange reserves is mainly concentrated on the motivations and benefits of reserve hoarding, while domestic consequences are given little attention. Discussions on the cost of reserve accumulation are mostly focused on the carry cost, which is estimated by comparing the return on reserve assets and the cost of corresponding liabilities. What happens in the domestic financial market in the process of central bank operations for reserve accumulation has not been addressed. By investigating how reserve accumulation affects domestic credit allocation, this paper aims to fill in this gap in the literature.



Figure 1.1: Reserve to GDP Ratio Changes between 2000 - 2015

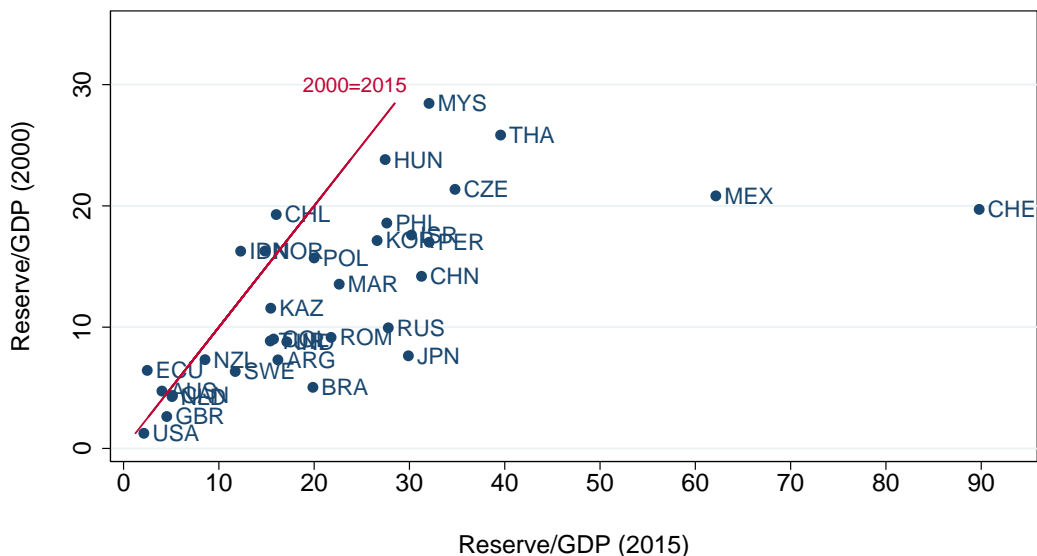

NOTES: Data is from the World Bank. 45 degree line is provided for comparison. Eurozone countries are excluded. Very small countries with 2015 GDP smaller than 100 billion USD are excluded. Hong Kong(62%, 112%) and Singapore(84%, 86%) are not displayed due to extreme values. Total of 33 countries are shown in the plot.

Conceptually, reserve accumulation is the same as foreign saving funded by central banks' domestic borrowing. It has been documented in the literature that heavy reserve accumulator countries have sterilized most of their reserve purchases. (See [Lavigne \(2008\)](#), [Reinhart and Reinhart \(2008\)](#), [Aizenman and Glick \(2009\)](#) or [Mehrotra \(2012\)](#)) Central banks have also declared that they absorb excessive liquidity after FX purchases.<sup>1</sup> To nullify the expansionary effect of reserve purchases on target interest rates, the central bank has to reduce its net domestic assets. Whether the sterilization is done through issuance of central banks' own securities, transfers from government, or raising reserve requirements, it amounts to central

<sup>1</sup>For example, the Bank of Korea states in the 2004 annual report([The Bank of Korea \(2004\)](#)) that "During the year, the Bank of Korea had no option but to absorb the excess liquidity supplied through the foreign sector owing to the widened current account surplus by means of the issue of Monetary Stabilization Bonds (MSBs) in order to maintain the call rate at its target level."

banks' borrowing from the domestic financial sector. The proceeds of this borrowing are exchanged with foreign currency in the local FX market and invested abroad in mostly safe assets.

Reserves were accumulated on a large scale, often dozens of percent of GDP, in many countries. The flip side is that central banks borrowed heavily from the domestic financial sector. Central banks' large scale borrowing could have serious implications in local financial markets. It may alter financial intermediaries' behavior and influence credit allocation in distortionary ways.<sup>2</sup> In this paper, I focus on banks' loan provision to private firms.

This paper shows that reserve accumulation reduces bank loans to firms. As central banks fund reserve purchases by borrowing from the domestic financial sector, banks are left with less funds. If domestic assets are imperfect substitutes for foreign assets so that the banks cannot borrow from abroad the same amount they lend to the central bank, banks would need to reduce loans to firms. I describe this mechanism by developing a simple two-period small open economy model, and provide empirical evidence from Korean banks' monthly balance sheets over September 2003 to August 2008.

The analytical model describes the mechanism of crowding-out. On top of an otherwise standard FX intervention model, I introduce production, capital and loans. The model assumes that reserves are funded by domestic borrowing. As the central bank channels funds abroad, the local financial market becomes short

---

<sup>2</sup>For instance, banks may opt to increase the riskiness of their portfolio to offset the effect of low yield sterilization assets that they are forced to hold. The second chapter discusses this effect. See also [Yu \(2014\)](#) for similar argument with Chinese reserve accumulation case, and [Kumhof and Tanner \(2005\)](#) for discussion on the effect of government debt on bank portfolio.

of funds and tries to borrow more from abroad. But the foreign demand for home bonds is finitely elastic. International financial intermediation is subject to a limited liability constraint and uncovered interest rate parity fails. The private sector can only partially offset the public outflows, so Ricardian equivalence also fails. Consequently, bank loans are crowded out, and this negatively affects investment and capital accumulation. The ratio of the reduction in loans to the accumulated reserves, which I define as crowding-out coefficient, is between zero and one.

This paper provides bank level evidence for the crowding out effect of reserve accumulation. I investigate monthly balance sheets of all banks in Korea over the massive reserve accumulation period (September 2003 to August 2008). First, I find that bank loans to private firms declined after reserve accumulation. The crowding-out coefficient is estimated to be 0.5. Second, I examine whether reserve accumulation leads banks to cut loans by exploiting two factors that would make some banks more responsive than others. I find that stronger banks, namely larger, more capitalized banks with abundant core deposits, reduce loans more after reserve accumulation. They can be more responsive in cutting loans and lending to the central bank because they can expand lending easily again later. This is consistent with another finding, that foreign bank branches are much more responsive to reserve accumulation than domestic banks. The main business of those branches is not in making loans but in trading securities. They are eager to cut loans when more profitable sterilization securities are supplied.

The remainder of this chapter is organized as follows. Section 1.2 overviews related literature and documents the contributions of this paper. Section 1.3 provides

the analytical model that describes the domestic consequences of reserve accumulation, including reduction in bank loans. Section 1.4 investigates the data and Section 1.5 concludes.

## 1.2 Related Literature

Existing models of reserve accumulation describe reserves as being accumulated by lump-sum taxation or by a representative agent's voluntary saving. Examples include [Caballero and Panageas \(2005\)](#), [Durdu et al. \(2009\)](#), [Alfaro and Kanczuk \(2009\)](#), [Jeanne and Ranciere \(2011\)](#), [Jeanne \(2012\)](#), [Benigno and Fornaro \(2012\)](#), and [Bacchetta et al. \(2013\)](#). Reserve accumulation has limited effects on domestic financial market in these models as the reserve accumulation is not central bank's borrowing. There are some FX intervention models that describe intervention as being executed by central bank's borrowing. However, they do not have competing private borrowers. See [Gabaix and Maggiori \(2015\)](#), [Amador et al. \(2016\)](#). By construction, they fail to observe the effect of reserve accumulation on other borrowers in the economy. I develop a reserve accumulation model which has private borrowers and reserves are accumulated by central bank's borrowing. Using the model, I show analytically that bank loans, investment, and capital are crowded out after reserve accumulation.

This paper adds to the literature on the cost of reserves. This literature is mainly focused on direct sterilization costs or the carry cost of reserves. They estimate the spread of sterilization bonds over the interest earned from reserves.

Examples are [Calvo \(1991\)](#), [Calvo et al. \(2012\)](#), [Rodrik \(2006\)](#), [Lavigne \(2008\)](#), and [Adler and Mano \(2016\)](#). [Calvo \(1991\)](#) investigates this cost and warns of the “perils” of sterilized intervention. [Calvo et al. \(2012\)](#) also weigh the cost of reserves using this measure. [Rodrik \(2006\)](#) suggests a similar but different definition of reserve cost. He argues that the “social cost” of reserves should be calculated from the spread between the yield on reserves and the cost of foreign borrowing, since reserves could have been used to reduce the country’s external debts.

More closely related to this paper are [Reinhart et al. \(2016\)](#) and [Cook and Yetman \(2012\)](#). [Reinhart et al. \(2016\)](#) relate the decline of growth in Asia after 2000 with reserve accumulation and bring up the possibility that private sector investments have been crowded out by reserve accumulation. Their argument is supported by correlations of macro aggregates and VAR evidence. [Cook and Yetman \(2012\)](#) compare 2003 and 2007 balance sheets of 55 banks in Asia and find that a 1% increase in reserves is associated with a 1.3% decline in loan growth. My paper contributes to the literature on cost of reserves by investigating the negative effect of reserve accumulation on bank lending and the role of bank heterogeneity.

This paper is also related to the burgeoning literature on bank lending behavior. Bank lending has been an important interest of many researchers since it can affect resource allocation, productivity and growth. Many factors that can affect bank lending have been examined by the literature. [Buch and Goldberg \(2014\)](#) study how liquidity risk affects bank lending in different countries. [Baskaya et al. \(2017\)](#) show that capital inflows lead to bank loan expansion in Turkey. [Jiménez et al. \(2014\)](#) find that expansionary monetary policy induces lowly capitalized banks

to provide more loans to risky firms. [Rodnyansky and Darmouni \(2016\)](#) find effects of U.S. quantitative easing on bank lending. [Ivashina and Scharfstein \(2010\)](#) identify banks which cut lending more than others during the Great Recession, exploiting cross-sectional differences in bank characteristics. The contribution of my work to this literature is that I investigate a previously unstudied shock, reserve accumulation with a new dataset from Korea.

### 1.3 The Model

I study a two period ( $t = 1, 2$ ) small open economy model. The economy is inhabited by households, firms and banks, each with a unit measure. There is a central bank which accumulates foreign exchange reserves. In general, the need for FX reserves would arise from precaution against sudden stops, or from the desire of achieving a trade surplus. I do not provide a particular justification in this paper, although the model shows trade balance improvement through reserve accumulation. Instead, I take central bank intervention as given and focus on its effects on firms, bank loans and production. In addition, there is a continuum of foreign investors channelling international capital flows.

### 1.3.1 Households

A continuum of identical households consume two goods, home goods and foreign goods. Home goods are the numeraire in this economy, and are produced by domestic firms, while foreign goods are the numeraire outside this economy, and are imported. I abuse the word currency to mean a claim to the numeraire of the economy hereafter. The exchange rate  $e_t$  is defined as the price of a unit of foreign good in units of home goods at time  $t$ . An increase in  $e_t$  is therefore depreciation as usual. The households' problem is:

$$\begin{aligned} \max \quad & \ln C_1 + \beta \ln C_2 \\ \text{s.t.} \quad & C_t \equiv C_{H,t}^\chi C_{F,t}^{1-\chi} \\ & C_{H,1} + e_1 C_{F,1} = \pi_{B,1} \end{aligned} \tag{1.1}$$

$$C_{H,2} + e_2 C_{F,2} = \pi_{B,2} + \pi_F - \tau \tag{1.2}$$

$\chi$  governs the household preference over home goods and foreign goods, and is between zero and one. Households own banks and firms and earn profits  $\pi_{B,t}, \pi_F$ , respectively.  $\tau$  is a tax levied by the central bank, which will be explained later.

The households' problem is stylized as I strive to focus on transactions between banks and firms. The households do not participate in the domestic financial market directly. Instead, they smooth consumption through their ownership of banks.<sup>3</sup> The only decision of the households is on the consumption ratio between home goods

---

<sup>3</sup>This feature is also present in [Benigno and Fornaro \(2012\)](#).

and foreign goods, which satisfies

$$\frac{\chi}{C_{H,t}} = \frac{1 - \chi}{e_t C_{F,t}} = \lambda_t \quad (1.3)$$

In the optimum, the marginal utility per one unit of domestic currency spending is the same in both home good and foreign good consumption, and equals  $\lambda_t$ .

To clear the home goods market, I need to introduce a demand curve of the rest of the world (RoW). From Equation (1.3), we see that the households devote a fraction  $(1 - \chi)$  of total expenditure  $E_t$  to foreign goods ( $e_t C_{F,t} = (1 - \chi)E_t$ ). By symmetry, I assume that RoW spends  $(1 - \chi)$  portion of its total expenditure  $E_t^*$  on home goods.

$$\frac{1}{e_t} C_{H,t}^* = (1 - \chi) E_t^*$$

By normalizing  $E_t^* = (1 - \chi)^{-1}$ , I make foreign demand for home goods the same as the exchange rate.

$$C_{H,t}^* = e_t \quad (1.4)$$

### 1.3.2 Firms

The firms operate with a CRS technology where capital is the only input.  $z$  is the productivity.

$$Y_t = zK_t$$



A representative firm enters the first period with initial capital  $K_1$  and existing debt  $L_1$  owed to the banks. It is assumed that the initial debt is same as the first period output ( $L_1 = zK_1$ ), so the firm produces with initial capital and uses the entire output to pay back the initial debt. The firm can get loan  $L_2$  from the banks and uses it to invest in  $K_2$ . Capital does not depreciate. Investment is done using home goods and is irreversible.<sup>4</sup> The firm yields profit to the households only in the terminal period. Consequently, the firms' problem is as follows:

$$\max \quad \pi_F = zK_2 - RL_2 \quad (1.5)$$

$$s.t. \quad K_2 = K_1 + L_2 \quad (1.6)$$

The borrowing rate in this economy is  $R$  and the capital rate of return is  $z$ . The solution to firms' problem shows that  $R$  and  $z$  should be equal to each other in any equilibrium.

$$R = z \quad (1.7)$$

For simplicity and analytical results, I further assume here the following.

$$\beta z = 1$$

Therefore, the capital rate of return  $z$  is  $\beta^{-1}$ . This assumption is harmless for the purpose of this model, because household consumption smoothing is not the focus.

---

<sup>4</sup>If investment is done by foreign goods (or more generally, some combination of foreign goods and home goods), reserve accumulation will crowd out bank loans even more because it will make investment more expensive. I close this channel by assuming investment is done only using home goods, and focus on the crowding out of loans due to imperfect international capital flows.

### 1.3.3 Banks

A representative bank yields profit to the households in both periods. Essentially, it does consumption smoothing on behalf of the households. It can also issue bonds to the foreign investors. The bank's problem is:

$$\begin{aligned} \max \quad & \pi_{B,1} + \beta \frac{\lambda_2}{\lambda_1} \pi_{B,2} \\ \text{s.t.} \quad & L_1 + B = \pi_{B,1} + L_2 + S \end{aligned} \tag{1.8}$$

$$RL_2 + RS = \pi_{B,2} + RB \tag{1.9}$$

$\lambda_t$  is the households' marginal utility at time  $t$ .  $B$  is banks' bond issuance which will be bought by foreign investors, and  $S$  is lending to the central bank. In the absence of risk, all domestic liabilities are perfectly substitutable. Hence, all domestic bonds in this model bear the same interest rate  $R$ . The banks' first order condition is a typical Euler equation.

$$\lambda_1 = \beta R \lambda_2 \tag{1.10}$$

### 1.3.4 Foreign Investors

There is a growing literature on segmented international financial markets in which foreign demand for home bonds is finitely elastic.<sup>5</sup> I follow this literature to bring uncovered interest rate parity failure into the model.

---

<sup>5</sup>For example, see [Gabaix and Maggiori \(2015\)](#), [Fanelli and Straub \(2016\)](#), and [Amador et al. \(2016\)](#).

There is a continuum of foreign investors. They start with no capital of their own and trade bonds. A foreign investor's balance sheet consists of  $q$  units of domestic currency(home goods) and  $-q/e_1$  obligation in foreign currency(foreign goods), where  $q$  is the domestic currency bonds in which the investor is long of and  $-q/e_1$  is the corresponding valued bond in foreign currency. They borrow  $q/e_1$  from the foreign financial market in foreign currency at world interest rate  $R^*$  and exchange it with domestic currency in the SOE's FX market.<sup>6</sup> Then they lend  $q$  to domestic banks at rate  $R$ . Hence the value of the foreign investor in terms of home currency as of period two is:

$$V = \left( R - R^* \frac{e_2}{e_1} \right) q = \Omega q \quad (1.11)$$

After taking positions, the foreign investor can divert a portion  $\Gamma|\frac{q}{e_1}|$  of the funds it intermediates.<sup>7</sup> If the foreign investor diverts the funds, it would get the proceeds from diversion in period two, and the lenders to the foreign investor recover a portion  $1 - \Gamma|\frac{q}{e_1}|$  of their credit position  $|\frac{q}{e_1}|$ . Since lenders correctly anticipate the investors' incentives for diversion, the foreign investors are subject to a credit constraint of the form:

$$\frac{V}{e_1} \geq \Gamma \left| \frac{q}{e_1} \right| \cdot \left| \frac{q}{e_1} \right| \quad (1.12)$$

Since the value of the firm is linear in the position  $q$ , while the right hand side

---

<sup>6</sup>It is assumed that the exogenous world interest rate  $R^*$  is smaller than the rate of return  $z$  of this economy as we are analyzing private capital inflows.

<sup>7</sup>Hence,  $\Gamma|\frac{q}{e_1}|$  is a proportion. Combining the foreign investors' value and constraints,  $\Gamma|\frac{q}{e_1}| = \frac{V}{q} = \Omega$ .  $\Gamma|\frac{q}{e_1}| < 1$  is always satisfied in an equilibrium if one makes a mild assumption that the return rate of FX intermediation is less than 100%. ( $-1 < \Omega < 1$ )

of the constraint is convex in  $q$ , the constraint always binds. Substituting the value into the constraint, and aggregating across the unit mass of foreign investors, the capital inflow from abroad  $Q$  is derived as:

$$Q = \frac{1}{\Gamma} (Re_1 - R^*e_2) \quad (1.13)$$

In foreign currency terms, the capital flow to this economy in period one is

$$\frac{Q}{e_1} = \frac{1}{\Gamma} \left( R - R^* \frac{e_2}{e_1} \right)$$

In these expressions, the term in parenthesis is the deviation from the uncovered interest rate parity condition. So the capital flow is linear in the deviation from UIP and  $\Gamma$  is the parameter that governs the degree of openness of this economy. If  $\Gamma$  is zero then international capital flows are frictionless and UIP holds. When  $\Gamma$  goes to infinity, then there are no capital flows and the economy is in financial autarky. In what follows,  $\Gamma$  is assumed to be a positive number and UIP fails in the model economy.<sup>8</sup>

---

<sup>8</sup>In the absence of uncertainty, expected return is the same as realized return in this model. Hence, UIP violation also means CIP violation. In the data, UIP does not hold but CIP does. This is problematic to the literature of segmented international markets. As it is pointed out by [Amador et al. \(2016\)](#), however, segmented market models predict that the CIP gap increases with reserve accumulation, which is consistent with the data.

### 1.3.5 Central Bank

For reasons exogenous to the model, the central bank sets a target for foreign exchange reserves of  $F$  measured in units of foreign currency. It cannot borrow from foreigners ( $F \geq 0$ ), and the reserve accumulation cannot exceed total exports which are equal to one in terms of foreign currency ( $F \leq 1$ ).<sup>9</sup> It borrows  $S$  from the domestic financial market, converts this to foreign currency in the FX market and invests abroad.

For the sake of completeness, the central bank brings the return on reserves back to the home country and pays back the domestic debt in period 2. Through this operation the central bank may occur fiscal losses. It covers the loss by lump-sum taxation on the households. The central bank budget constraints in each period are:

$$S = e_1 F \tag{1.14}$$

$$R^* e_2 F + \tau = RS \tag{1.15}$$

Equation (1.15) determines the amount of tax  $\tau$  needed for a given reserve  $F$ .

---

<sup>9</sup>Reserves not exceeding total exports is a mild assumption. For instance, in the year 2007, the Korean exports of goods were 382 billion USD while reserves outstanding at the end of the same year were 262 billion USD.

### 1.3.6 Equilibrium

There are four markets to be cleared in this economy. The market clearing conditions are as below.

- Home goods market

$$C_{H,1} + C_{H,1}^* + (zK_1 - L_1 + L_2) = zK_1 \quad (1.16)$$

$$C_{H,2} + C_{H,2}^* = zK_2 \quad (1.17)$$

- Loans market

$$L_2^D = L_2^S \quad (1.18)$$

- Bank borrowing

$$B = Q \quad (1.19)$$

- FX market

$$\underbrace{zK_1 - \frac{\chi}{\lambda_1} - K_2}_{\text{export}} + \underbrace{K_1 - \frac{1-\chi}{\lambda_1}}_{\text{import}} + \underbrace{Q - e_1 F}_{\text{capital flow}} = 0 \quad (1.20)$$

$$\underbrace{zK_2 - \frac{\chi}{\lambda_2}}_{\text{export}} - \underbrace{\frac{1-\chi}{\lambda_2}}_{\text{import}} - \underbrace{RQ + R^* e_2 F}_{\text{capital flow}} = 0 \quad (1.21)$$

The FX market clearing conditions are derived from combining budget constraints of each agent. These are the resource constraints of this economy.

## Equilibrium Definition

An equilibrium is defined as a set of allocations  $\{C_{H,1}, C_{F,1}, C_{H,2}, C_{F,2}, C_{H,1}^*, C_{H,2}^*, \lambda_1, \lambda_2, L_2, K_2, B, Q, S, \tau, \pi_F, \pi_{B,1}, \pi_{B,2}\}$  and prices  $\{e_1, e_2, R\}$  that satisfies equations (1.1)-(1.10), (1.13)-(1.17), and (1.19)-(1.21) given target FX reserve  $F$ , initial capital  $K_1$  and world interest rate  $R^*$ .

Note that (1.3) and (1.4) constitute two equations each, so the number of unknowns matches the number of equations.

## Existence and uniqueness of the equilibrium

The equations that define the equilibrium are linear in endogenous variables. The coefficient matrix of the equation system is non-singular and a unique equilibrium exists. Formal proof is provided in Appendix A.

### 1.3.7 Effect of Reserve Accumulation

I describe the domestic consequence of reserve accumulation with the following five propositions. They characterize the effect of reserve accumulation on capital flows, bank loans, the exchange rate, the trade balance, and consumption. The analysis is focused on the first period. The propositions are derived from the model's closed form solution. Proofs are provided in Appendix A.

**Proposition 1.** (Ricardian equivalence failure) *Private capital inflows only partially offset public capital outflows.*

$$0 < \frac{\partial(Q/e_1)}{\partial F} < 1$$

The numerator is private capital inflows and the denominator is public outflows, both measured in foreign currency. As the central bank channels funds abroad, the banks are short of funds to make loans and borrow more from abroad. Because of the friction in international capital flows, however, the additional borrowing is smaller than the funding shortage caused by reserve accumulation.

The model captures the two-way capital flows of private inflows and public outflows. The model is consistent with the empirical finding of [Alfaro et al. \(2014\)](#) that private capital inflows are obscured by large public outflows in reserve accumulating countries.

**Proposition 2.** (Loan crowding-out) *Banks cut loans to firms when the central bank accumulates more reserves.*

$$\frac{\partial L_2}{\partial F} < 0$$

Thus, reserve accumulation leads banks to cut loans to firms. Loans in this model are used only for investment. Hence, this proposition can also be read as ‘Reserve accumulation crowds out capital accumulation.’ The following corollary compares the size of reduced loans with accumulated reserves.



**Corollary 1.** (Crowding-out coefficient) *The model crowding-out coefficient is calculated as below.*

$$-\frac{\partial L_2}{\partial F} \frac{1}{e_1} = \frac{R^*(1+R^*)F^2 - \frac{2R^*}{\Gamma}(1+z)(z-R^*)F + \frac{1+R^*}{\chi} + \frac{R^*(1+z)^2}{\chi\Gamma} - \frac{(z-R^*)^2}{\Gamma}}{\left(1 + \left(\frac{z-1}{\Gamma} + F\right)R^*\right) \left(-R^*(1+z)F^2 + \left(\frac{R^*}{\chi}(\chi+z) - \frac{1}{\chi} - z\right)F + \frac{1+z}{\chi}\left(1 + \frac{z(1+R^*)}{\Gamma}\right)\right)}$$

The crowding-out coefficient is defined as the ratio of reduced loans to accumulated reserves. Using the period one ex-post exchange rate, the model crowding-out coefficient is derived as above. Numerical examples in the appendix illustrate that this coefficient is between zero and one. In the Section 4, this coefficient is empirically estimated to be 0.48 for Korea.

**Proposition 3.** *The exchange rate depreciates as reserves are accumulated.*

$$\frac{\partial e_1}{\partial F} > 0$$

As in [Kumhof \(2010\)](#) and [Gabaix and Maggiori \(2015\)](#), sterilized intervention can affect the exchange rate because domestic and foreign assets are imperfect substitutes. Through reserve accumulation, the central bank supplies domestic currency, demanding foreign currency. The private sector cannot undo the central bank action perfectly. As a result, the exchange rate depreciates.

The exchange rate is the same as exports in this model, hence this proposition also says that exports increase after reserve accumulation.

**Proposition 4.** (Consumption crowding-out) *Consumption of both home goods and foreign goods is crowded out by reserve accumulation.*

$$\frac{\partial C_{H,1}}{\partial F} < 0 \text{ and } \frac{\partial C_{F,1}}{\partial F} < 0$$

Like other models of reserve accumulation, this model exhibits consumption crowding out for home goods and foreign goods as reserve accumulation is akin to forced saving to the households.

**Proposition 5.** *The period one trade balance increases in reserve accumulation.*

$$\frac{\partial TB_1}{\partial F} > 0$$

Exports increase and imports decrease with more reserves being accumulated. As a result, the trade balance in period 1 improves. This might imply a mercantilist motivation for reserve accumulation if there is a dynamic benefit from running a trade surplus. This motivation is not discussed in this paper.

The propositions summarize the effect of reserve accumulation on the economy and show the mechanism. These propositions can be illustrated by numerical examples. I solve the model numerically and provide examples in the Appendix.

## 1.4 Empirical Investigation

In this section, I examine the impact of reserve accumulation on bank lending using bank level data from Korea. First, I show that bank loans fell after reserve accumulation in Korea over the massive reserve accumulation period of September 2003 to August 2008. Second, I investigate whether reserve accumulation leads banks to cut loans by exploiting cross-sectional differences of bank lending after reserve accumulation.

### 1.4.1 Data

The data used for the analysis in this paper come from the Bank of Korea (BOK). BOK collects detailed bank balance sheets every month from every bank which operates in Korea. This data contributes to monetary policy implementation and is also used for compilation of the official monetary and financial statistics. The data is more detailed than the publicly available quarterly financial statements of banks. It includes many items that are not on the public financial statements. For example, it reports loans to different types of debtors and securities in several categories.

The data encompass all banks that operate in Korea. There are 20 domestic banks and 47 foreign bank branches throughout the sample period of September 2003 to August 2008. As shown in Table 1.1, foreign bank branches are very different from domestic banks in size and asset composition. Foreign bank branches are

tiny in total assets size. Sum of 47 foreign bank branches' total assets is roughly one tenth of that of 20 domestic banks. 26.9% of the branches' total assets are invested in safe public bonds, while 5.4% are loans to private firms. This is in contrast with domestic banks. 30.3% of domestic banks assets are loans and only 7.1% are safe bonds.

Table 1.1: Bank Asset Composition

|                       | N  | Loans to<br>private firms | Gov't, central<br>bank bonds | Corporate<br>bonds | Total<br>assets   |
|-----------------------|----|---------------------------|------------------------------|--------------------|-------------------|
| Domestic banks        | 20 | 326.8<br>(30.3)           | 77.0<br>(7.1)                | 50.2<br>(4.7)      | 1077.5<br>(100.0) |
| Foreign bank branches | 47 | 6.2<br>(5.4)              | 30.8<br>(26.9)               | 0.8<br>(0.7)       | 114.6<br>(100.0)  |
| Top 5 branches        | 5  | 3.1<br>(11.5)             | 3.8<br>(14.0)                | 0.4<br>(1.6)       | 27.1<br>(100.0)   |

NOTES: The numbers are monthly average of sum across bank groups. Values are in 2003.9 real KRW. Numbers in parentheses are composition ratios. Loans cover only loans to private firms. Public bonds are government bonds and central bank bonds.

I construct two panels A and B to compare different banks. I exclude foreign bank branches from Panel A and study only regular domestic banks, and construct Panel B to include large foreign bank branches and compare their behavior with domestic banks. In particular, Panel A consists of the 20 regular domestic banks. The sample of banks varies from 17 to 19 throughout the period due to entry and exit. 15 banks have continuously been operating over the period. Panel B consists of the 20 banks in panel A plus 5 foreign bank branches whose average loans are larger

than 500 billion KRW (roughly 0.5 billion USD). I include only top five foreign bank branches in the sample, because other smaller branches are not making meaningful amount of loans. Summary statistics of key variables from both Panel A and Panel B are provided in the Table 1.2.

Table 1.2: Summary Statistics

|                                  | Mean  | SD    | P25   | P50   | P75   |
|----------------------------------|-------|-------|-------|-------|-------|
| Panel A: 20 domestic banks       |       |       |       |       |       |
| Total assets(tril. KRW)          | 62.58 | 52.72 | 16.39 | 54.08 | 98.40 |
| Log total assets                 | 17.41 | 1.23  | 16.61 | 17.81 | 18.40 |
| Loans to private firms(tril.KRW) | 18.98 | 16.70 | 5.93  | 11.04 | 34.14 |
| $\Delta \ln$ loans               | 0.01  | 0.02  | 0.00  | 0.01  | 0.02  |
| Core deposit ratio               | 0.53  | 0.18  | 0.46  | 0.57  | 0.65  |
| Capital ratio                    | 0.06  | 0.03  | 0.05  | 0.06  | 0.07  |
| Panel B: Panel A + 5 branches    |       |       |       |       |       |
| Total assets(tril. KRW)          | 51.70 | 52.31 | 9.20  | 22.16 | 85.53 |
| Log total assets                 | 17.02 | 1.39  | 16.03 | 16.91 | 18.26 |
| Loans to private firms(tril.KRW) | 15.44 | 16.64 | 1.65  | 7.53  | 22.22 |
| $\Delta \ln$ loans               | 0.01  | 0.06  | -0.01 | 0.01  | 0.02  |
| Core deposit ratio               | 0.45  | 0.24  | 0.25  | 0.51  | 0.63  |
| Capital ratio                    | 0.06  | 0.03  | 0.05  | 0.06  | 0.07  |

NOTES: P25, P50 and P75 refer to 25th, 50th and 75th percentile, respectively.

The main dependent variable in this study is bank loans. The data distinguish loans with different types of debtors and different currencies. I consider loans to private firms only and include both Korean Won loans and FX loans in the main variable  $\text{Loans}_{b,m}$ .  $b$  represents individual banks and  $m$  stands for month. All vari-

ables are deflated using September 2003 as the base month for inflation adjustment. The top and bottom 0.5% of loans and total assets are winsorized to reduce the impact of possible outliers.

### 1.4.2 Sample Period

The baseline analysis focuses on the five years from September 2003 to August 2008. Korea accumulated a large stock of reserves between the 1997 Asian Crisis and the 2008 Global Financial Crisis. After being bailed out by the IMF in 1997, Korea accumulated 242 billion USD over the next 10 years. By the end of 2007, the FX reserve stock reached 262 billion USD, which amounts to 23.4% of its GDP the same year.

Figure 1.2: Monthly Reserve Accumulation over the Sample Period

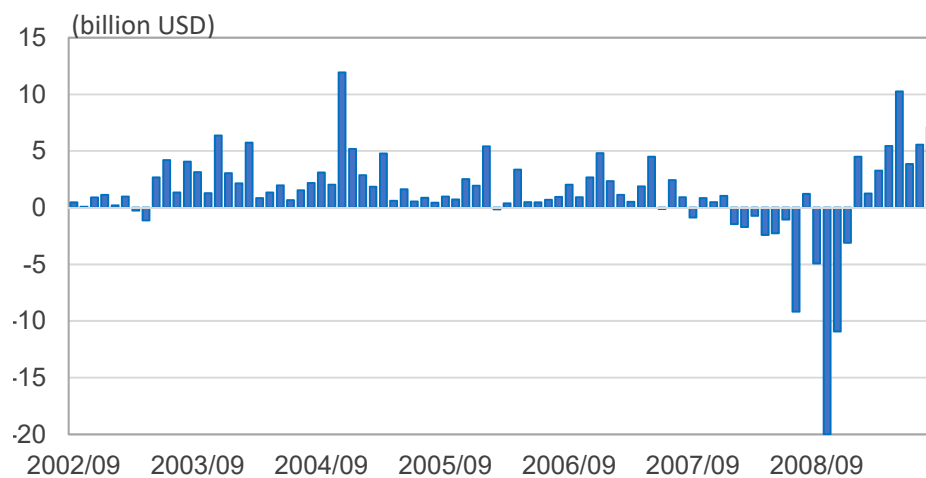

NOTES: The data is from the Bank of Korea. The sample period is from September 2003 to August 2008, while this graph shows the period from September 2002 to August 2009.

The sample period starts in September 2003 because the available data start from there. On the other side, the Global Financial Crisis period is excluded from the sample. Figure 1.2 shows the monthly reserve accumulation over the sample period. During the crisis, Korea experienced huge reserve decumulation, which is not of our interest. Over the sample period, Korea accumulated 92 billion USD reserves. This is roughly a quarter of the current stock of FX reserves(371 billion USD as of December 2016). Monthly average accumulation was 1.5 billion USD, with a standard deviation of 2.7 billion USD. Data for the period after the Great Recession is also available. However, this period involves more frequent decumulation episodes due to the European crisis and other events, so it is not appropriate for the analysis in this paper. Important macroeconomic statistics over the sample period are provided in Table 1.3.

Table 1.3: Macro Aggregates over the Sample Period

|                                   | Mean   | SD    | P25    | P50    | P75   |
|-----------------------------------|--------|-------|--------|--------|-------|
| Reserve accumulation(10 bil. USD) | 0.15   | 0.25  | 0.05   | 0.10   | 0.23  |
| Real GDP growth                   | 1.2    | 0.6   | 0.6    | 1.3    | 1.7   |
| Policy rate                       | 4.1    | 0.6   | 3.5    | 4.0    | 4.5   |
| Real exchange rate fluctuation    | -0.002 | 0.017 | -0.013 | -0.004 | 0.009 |

NOTES: P25, P50 and P75 refer to 25th, 50th and 75th percentile, respectively.

### 1.4.3 Bank Lending after Reserve Accumulation

I begin by examining the relationship between bank loans and reserve accumulation. To control for other factors that can influence bank lending, I run panel regressions with fixed effects and controls. The baseline regression equation is as follows:

$$\Delta \ln \text{Loans}_{b,m} = \alpha_b + \alpha_q + \lambda m + \beta \text{RA}_{m-1} + \gamma \mathbf{Bank}_{b,m-1} + \theta \mathbf{Macro}_{m-1} + \epsilon_{b,m} \quad (1.22)$$

where  $\alpha_b$  is a bank fixed effect;  $\alpha_q$  is a quarter fixed effect; and  $m$  is a linear trend variable. RA is Korea's monthly transaction of FX reserves, as reported in the balance of payments.

The baseline dependent variable is the change in the logarithm of a bank's loans. Different studies use different forms of the dependent variable in the literature. The change in log loans is used in [Jiménez et al. \(2017\)](#). The log level of loans is also popular: see [Baskaya et al. \(2017\)](#) and [Jiménez et al. \(2014\)](#). The ratio of the change in loans to total assets is used in the International Banking Research Network papers: see [Buch and Goldberg \(2014\)](#). I use the change in log loans form, although the regression results are robust to use of other different forms of the dependent variable.

When the dependent variable is in the change in log form, the bank fixed effect controls for the different trends of loans for individual banks, whereas the bank fixed effect absorbs different, time-invariant levels of loans across different banks when the



regressand is the log level of loans. The change in log form combined with bank fixed effects, assigns different trends of loan growth across banks, and absorbs more variation in the regressand. Over the sample period, different banks had different trend loan growth in the data, which is seemingly unrelated to reserve accumulation because monthly reserve accumulation had no trend as can be seen from Figure 1.2. As such, the change in log form is more suitable for this research.

In addition to the time and unit fixed effects, I include controls for individual bank characteristics. **Bank** is a set of bank level control variables which are standard in the literature. This includes banks' log total assets, capital ratio and core deposit ratio.

The timing and magnitude of reserve accumulation are decided by the central bank, presumably as a function of macroeconomic variables. To control for other macroeconomic factors that might affect bank loans, I include quarter fixed effects, a linear time trend, and the vector **Macro** which includes inflation, the real policy rate and the real exchange rate.<sup>10</sup> The quarter fixed effects absorbs quarterly differences in the loan growth rate, hence I use only the within quarter variation of loans. The linear trend absorbs within quarter linear trends. RA and other independent variables are lagged one month in order to mitigate endogeneity issues. All the regressions are based on weighted least squares using bank size as weight. Standard errors are clustered by banks.

Table 1.4 presents the results. Each column uses different forms of the depen-

---

<sup>10</sup>Regression results without real policy rate, real exchange rate are not very different from the main regression results.

dent variable. Column (1) uses the main form, the change in log loans. Results for the log level of loans are shown in column (2). Column (3) uses the ratio of the change in loans with respect to total assets. Regardless of how I define the change in loans, the coefficient is negative and significant. For both Panel A and Panel B, reserve accumulation is negatively associated with loan growth. The coefficients are statistically significant at the 1% level. The coefficients from Panel B are more negative than those of Panel A in all three columns.

The coefficients are also economically significant. Over the sample period, the standard deviation of monthly real reserve accumulation is 2.5 billion USD. Using the coefficient from column (1) for Panel A, I calculate that 2.5 billion USD reserve accumulation is associated with a decrease in the average loan growth rate of 0.40 percentage points. This is more than half of the average monthly loan growth rate of 0.69%.

I then estimate the crowding-out coefficient, proposed in Corollary 1. It is defined as the amount of reduction in loans after one dollar of reserve accumulation. I apply the coefficient from column (1) Panel A to total loans of all domestic banks and convert it to USD to compare with accumulated reserves:

$$\underbrace{-0.0161}_{\text{coefficient}} \times \underbrace{301.7 \text{ trillion KRW}}_{\text{total loans to private firms}^*} \div \underbrace{973 \text{ KRW/USD}}_{\text{real exchange rate}^*} = \underbrace{-5.0 \text{ billion USD}}_{\text{decrease in loans after 10 billion R.A.}}$$

\* as of March 2006(center of the sample period)

For total loans and the real exchange rate, I use the data of March 2006, which is

Table 1.4: Response of Bank Lending to Reserve Accumulation

|                        | (1)                              | (2)                       | (3)   |
|------------------------|----------------------------------|---------------------------|---|
|                        | $\Delta \ln(\text{loans}_{b,m})$ | $\ln(\text{loans}_{b,m})$ | $\frac{\Delta \text{loans}_{b,m}}{\text{assets}_{b,m-1}}$ |
| <b>Panel A</b>         |                                  |                           |   |
| RA <sub>m-1</sub>      | -0.0161***<br>(0.0038)           | -0.0174***<br>(0.0040)    | -0.469***<br>(0.1157)                                     |
| Observations           | 1,013                            | 1,013                     | 1,013   |
| Number of Banks        | 20                               | 20                        | 20  |
| R-squared              | 0.241                            | 0.847                     | 0.220   |
| <b>Panel B</b>         |                                  |                           |   |
| RA <sub>m-1</sub>      | -0.0252***<br>(0.0086)           | -0.0225***<br>(0.0049)    | -0.567***<br>(0.1887)                                     |
| Observations           | 1,257                            | 1,257                     | 1,257   |
| Number of Banks        | 25                               | 25                        | 25  |
| R-squared              | 0.067                            | 0.727                     | 0.062   |
| Macro controls & trend | yes                              | yes                       | yes   |
| Bank controls          | yes                              | yes                       | yes   |
| Quarter F.E.           | yes                              | yes                       | yes   |
| Bank F.E.              | yes                              | yes                       | yes   |

NOTES: The sample period is 2003.9-2008.8. RA is the reserve accumulation measured in 10 billion USD in the balance of payments. Loans and total assets are winsorized at the 0.5 and 99.5 percentiles. A constant is included in every regression but its coefficient is left unreported. Fixed effects and macro controls are either included(yes), not included(no), or spanned by another set of effects(-). Bank controls include log assets, core deposit ratio and capital ratio. Macro controls include inflation, real policy rate, and the real exchange rate. The coefficients for these controls are not reported. Regressions are all weighted-least squares, where weights are equal to the bank asset size. Standard errors are clustered by bank. \*\*\*, \*\* and \* denote significance at 1%, 5%, 10%, respectively.

the center of the sample period. The crowding-out coefficient is estimated as 0.5. This means that bank loans decline by 50 cents after one extra dollar of reserve accumulation.

#### 1.4.4 Cross-sectional Differences in Bank Lending

In this section, I explore cross-sectional differences of the response of bank lending to reserve accumulation to examine whether reserve accumulation leads banks to cut loans. In particular, I investigate two characteristics that can make some banks more responsive to reserve accumulation. First, I check whether large, sound banks are different from other banks in response to reserve accumulation. It would be easier for large and sound banks to cut loans and switch to assets offered by the central bank after reserve accumulation, since they can expand loans more easily later, compared to small and constrained banks.

Second, I check whether foreign bank branches are different in response to reserve accumulation than other ordinary domestic banks. It is a well known fact that foreign bank branches specialize in trading safe public securities on behalf of mother banks abroad. Making loans is not the main business for foreign bank branches although they do provide loans to firms. This can be confirmed from comparison of their asset composition with that of domestic banks. As can be seen from Table 1.1, 27% of foreign bank branches' assets are invested in safe bonds, while loans to firms account for only 5%. In contrast, loans to firms are 30% of

assets and safe bonds cover only 7% for domestic banks. As such, one can expect foreign bank branches to cut loans more aggressively than domestic banks when more central bank securities are supplied in the market as a consequence of reserve accumulation.

I investigate bank heterogeneity by interacting bank characteristics with reserve accumulation:

$$\Delta \ln \text{Loans}_{b,m} = \alpha_b + \alpha_m + \beta \text{RA}_{m-1} \times X_b + \gamma \mathbf{Bank}_{b,m-1} + \epsilon_{b,m} \quad (1.23)$$

$X_b$  is a set of bank characteristics including asset size, capital ratio, core deposit ratio, and a foreign bank branch dummy. These variables are averaged over the sample period and interacted with reserve accumulation. The main regressor in this specification varies over both banks and months, so I can use monthly fixed effects ( $\alpha_m$ ). When I use monthly fixed effects, the linear trend and macro controls are not carried over from the previous specification.

Table 1.5 shows the results. Columns (1)-(2) are regressions on Panel A, and (3)-(4) are regressions on Panel B. Note that columns (1) and (3) do not include monthly fixed effects. Instead they have quarter fixed effects, macro controls and linear trend. Column (2) and (4) have monthly fixed effects, so the regression equation is exactly Equation (1.23). Column (1) includes the RA term directly without having monthly fixed effects. The coefficient is similar to that of Table 1.4. It shows that reserve accumulation is negatively associated with the loan growth rate. Looking at the interaction terms in column (1), we see that larger banks,

Table 1.5: Cross-sectional Determinants of Bank Lending

|  | <b>Panel A</b>             |                            | <b>Panel B</b>             |                            |
|--|----------------------------|----------------------------|----------------------------|----------------------------|
|  | (1)                        | (2)                        | (3)                        | (4)                        |
|  | $\Delta \ln(\text{loans})$ | $\Delta \ln(\text{loans})$ | $\Delta \ln(\text{loans})$ | $\Delta \ln(\text{loans})$ |
| $RA_{m-1}$                               | -0.0157***<br>(0.0036)     |                            | -0.0259***<br>(0.0078)     |                            |
| $\ln \text{asset}_b \times RA_{m-1}$     | -0.00550***<br>(0.0015)    | -0.00541***<br>(0.0015)    | -0.00744***<br>(0.0019)    | -0.00724***<br>(0.0019)    |
| Core Deposit Ratio $_b \times RA_{m-1}$  | -0.0226**<br>(0.0105)      | -0.0227*<br>(0.0109)       | -0.0336**<br>(0.0139)      | -0.0318**<br>(0.0135)      |
| Capital Ratio $_b \times RA_{m-1}$       | -0.155**<br>(0.0620)       | -0.162**<br>(0.0637)       | -0.0989<br>(0.1133)        | -0.0925<br>(0.1125)        |
| Foreign Bank Branch $_b \times RA_{m-1}$ |                            |                            | -0.0817***<br>(0.0107)     | -0.0796***<br>(0.0102)     |
| Observations                             | 1,013                      | 1,013                      | 1,257                      | 1,257                      |
| Number of Banks                          | 20                         | 20                         | 25                         | 25                         |
| R-squared                                | 0.250                      | 0.372                      | 0.076                      | 0.114                      |
| Macro controls & trend                   | yes                        | -                          | yes                        | -                          |
| Bank controls                            | yes                        | yes                        | yes                        | yes                        |
| Quarter F.E.                             | yes                        | -                          | yes                        | -                          |
| Month F.E.                               | no                         | yes                        | no                         | yes                        |
| Bank F.E.                                | yes                        | yes                        | yes                        | yes                        |

NOTES: The sample period is 2003.9-2008.8. RA is the reserve accumulation measured in 10 billion USD in the balance of payments. Loans and total assets are winsorized at the 0.5 and 99.5 percentiles. All interaction terms are demeaned. A constant is included in every regression but its coefficient is left unreported. Fixed effects and macro controls are either included(yes), not included(no), or spanned by another set of effects(-). Bank controls include log assets, core deposit ratio and capital ratio. Macro controls include inflation, real policy rate and the real exchange rate. The coefficients for these controls are not reported. Regressions are all weighted-least squares, where weights are equal to the bank asset size. Standard errors are clustered by bank. \*\*\*, \*\* and \* denote significance at 1%, 5%, 10%, respectively.

banks with abundant core deposits, and more capitalized banks reduce loans more after reserve accumulation. This result remains valid in column (2), where I absorb time series variation using monthly fixed effects.

Regressions on Panel B suggest similar results. The absolute value of coefficients become larger compared to the regressions on Panel A, and the interaction term with the capital ratio loses statistical significance in Panel B. An important result is that the coefficient on the interaction of RA with the foreign bank branch dummy is negative and significant. Column (3) suggests that foreign bank branches cut loans roughly four times more than domestic banks after reserve accumulation. This result remains valid in column (4), where monthly fixed effects are included.

The economic significance of bank heterogeneity can be checked by examining the differences in responses of banks with interquartile differences in each characteristic. From column (2) of Table 1.5, after a 2.5 billion USD reserve accumulation, the loan growth rate declines 0.22 percentage points more in a bank at the 75th percentile of assets compared to a bank at the 25th percentile of assets. The loan growth rate declines 0.10 percentage points more in a bank with a 75th percentile core deposit ratio compared to a bank at the 25th percentile. The loan growth rate declines 0.08 percentage points more in a bank with a 75th percentile capital ratio compared to a bank with a 25th percentile capital ratio. In addition, column (4) suggests that foreign bank branches reduce loans 2.0 percentage points more than domestic banks after reserve accumulation of 2.5 billion USD.

### 1.4.5 Robustness Check

The regression results are robust to various changes. I report additional results in the following tables. First, Table 1.6 presents results using different forms of the dependent variable and different sample periods. Columns (1) and (2) use the change in loans normalized by bank assets as the dependent variable. The results are similar with the benchmark results in Table 1.5. Columns (3) and (4) show results for a different sample period. Since reserve decumulation over the Great Recession started as early as January 2008, the regressions in columns (3) and (4) exclude 2008 observations. The absolute value of coefficients get larger while statistical significance is not affected.

Table 1.7 presents results using only local currency loans. In the benchmark regressions, the dependent variable bank loans includes both FX loans and KRW loans. In terms of quantity, FX loans and KRW loans are roughly in the ratio of 1 to 9. The regressions in Table 1.7 exclude FX loans, but are not substantially different from the benchmark results.

Table 1.8 shows results with different bank categories. Columns (1) and (2) shows result with the primary dealer dummy. Each year, the bank of Korea announces a group of financial intermediaries which can participate in the primary market of sterilization securities. The selection is mainly based on soundness and past security transaction records of the intermediaries. The dummy variable  $\text{Primary Dealer}_b$  equals one if the bank was a primary dealer for at least four years within the five years of the sample period. The results show that primary dealer



banks cut loans more than other banks. The coefficient on the interaction term, however, lose its statistical significance once bank size, capital ratio, and core deposit ratio interaction terms are included together.

In columns (3) and (4), I use a dummy variable for nationwide banks. The 20 domestic banks can be categorized into 14 nationwide banks and 6 local banks. In general, nationwide banks are larger in asset size than local banks. Columns (3) and (4) compare the impact of reserve accumulation across three different groups of banks: nationwide banks, local banks and foreign bank branches. The base group is local banks. The coefficient on reserve accumulation is -0.0241 for the local bank group, -0.0341 for the nationwide bank group and -0.0796 for foreign bank branches. All those coefficients are statistically significant. Thus, the results show that nationwide banks reduce loans more than local banks after reserve accumulation. Foreign bank branches reduce loan even more than nationwide banks. However, the coefficient on the interaction term of nationwide dummy and RA lose statistical significance once the other interaction terms with bank size, capital ratio and core deposit ratio are included. The coefficient on the interaction of foreign bank branches dummy and RA stays significant after including the other interaction terms as previously reported in Table 1.5.

Table 1.9 provides results using the log rather than the level of reserve accumulation. To avoid negative values, the monthly reserve accumulation is re-scaled by adding 10 billion USD to every observation. By taking logs, the possible effect of outliers in the main independent variable is reduced. The regression results are similar to the benchmark results, except that the interpretation of the main coefficient

is now an elasticity.

Finally, Table 1.10 presents results from a placebo test. The goal of reserve accumulation is often thought to be exchange rate manipulation. One might worry that it is the change in the exchange rate that causes the change in bank loans, as the debtor firms are affected by exchange rate fluctuation. As a placebo test, I replace reserve accumulation with the growth rate of the exchange rate. I do not find any significant results from this regression.

## 1.5 Conclusion

This paper investigates an opportunity cost of FX reserve accumulation: reduction in bank loans to private firms. A simple FX intervention model shows that bank loans are crowded out by reserve accumulation. The reduction in loans leads to falls in investment and the capital stock. Empirical evidence from bank balance sheets suggests that bank loans are reduced after reserve accumulation. Particularly, the effect is larger in stronger banks and foreign bank branches.

This paper provides an important policy implication on how sterilized reserve accumulation can help open economies deal with large capital inflows and currency appreciation. There is a view that capital inflows lead to asset price inflation and credit increases. Policy makers believe that capital inflows are expansionary. This is supported by empirical evidences in the literature. For example, [Baskaya et al. \(2017\)](#) show that capital inflows decrease the cost of borrowing and lead to credit

expansion. The evidence presented in this paper shows that sterilized reserve accumulation has contractionary effects by reducing loans and leverage. Reserve accumulation not only works against exchange rate appreciation, but also partially offsets the expansionary effect of capital inflows. This paper explains why foreign exchange intervention is a favored tool to cope with capital inflows in many countries.

Table 1.6: Different Regressand Form and Sample Period

|  | (1)                          | (2)                          | (3)                        | (4)                        |
|--|------------------------------|------------------------------|----------------------------|----------------------------|
|  | $\Delta \text{loans/assets}$ | $\Delta \text{loans/assets}$ | $\Delta \ln(\text{loans})$ | $\Delta \ln(\text{loans})$ |
| $RA_{m-1}$                                     | -0.460***<br>(0.1138)        |                              | -0.0205***<br>(0.0060)     |                            |
| $\ln \text{asset}_b \times RA_{m-1}$           | -0.142***<br>(0.0391)        | -0.139***<br>(0.0395)        | -0.00790***<br>(0.0027)    | -0.00759***<br>(0.0027)    |
| $\text{Core Deposit Ratio}_b \times RA_{m-1}$  | -0.684**<br>(0.2816)         | -0.684**<br>(0.2893)         | -0.0387**<br>(0.0160)      | -0.0361**<br>(0.0165)      |
| $\text{Capital Ratio}_b \times RA_{m-1}$       | -4.494**<br>(1.7698)         | -4.737**<br>(1.8236)         | 0.199<br>(0.1749)          | 0.205<br>(0.1766)          |
| $\text{Foreign Bank Branch}_b \times RA_{m-1}$ |                              |                              | -0.0883***<br>(0.0127)     | -0.0856***<br>(0.0128)     |
| Sample Period                                  | 03.9-08.8                    | 03.9-08.8                    | 03.9-07.12                 | 03.9-07.12                 |
| Observations                                   | 1,013                        | 1,013                        | 1,087                      | 1,089                      |
| Number of Banks                                | 20                           | 20                           | 25                         | 25                         |
| R-squared                                      | 0.226                        | 0.350                        | 0.080                      | 0.119                      |
| Macro controls & trend                         | yes                          | -                            | yes                        | -                          |
| Bank controls                                  | yes                          | yes                          | yes                        | yes                        |
| Quarter F.E.                                   | yes                          | -                            | yes                        | -                          |
| Month F.E.                                     | no                           | yes                          | no                         | yes                        |
| Bank F.E.                                      | yes                          | yes                          | yes                        | yes                        |

NOTES: The sample periods are 2003.9-2008.8. in columns (1)-(2) and 2003.9-2007.12 in columns (3)-(4). Columns (1)-(2) are on panel A, and (3)-(4) are on panel B. RA is the reserve accumulation measured in 10 billion USD in the balance of payments. Dependent variables in columns (1)-(2) are multiplied by 100. Loans and total assets are winsorized at the 0.5 and 99.5 percentiles. All interaction terms are demeaned. A constant is included in every regression but its coefficient is left unreported. Fixed effects and macro controls are either included(yes), not included(no), or spanned by another set of effects(-). Bank controls include log assets, core deposit ratio and capital ratio. Macro controls include inflation, real policy rate and the real exchange rate. The coefficients for these controls are not reported. Regressions are weighted-least squares, where weights are equal to the bank asset size. Standard errors are clustered by bank. \*\*\*, \*\* and \* denote significance at 1%, 5%, 10%, respectively.

Table 1.7: KRW Loans

|  | (1)                            | (2)                            | (3)                            |
|--|--------------------------------|--------------------------------|--------------------------------|
|  | $\Delta \ln(\text{KRW loans})$ | $\Delta \ln(\text{KRW loans})$ | $\Delta \ln(\text{KRW loans})$ |
| $\text{RA}_{m-1}$                                    | -0.0135***<br>(0.0039)         | -0.0131***<br>(0.0036)         |                                |
| $\ln \text{asset}_b \times \text{RA}_{m-1}$          |                                | -0.00586***<br>(0.0013)        | -0.00573***<br>(0.0013)        |
| $\text{Core Deposit Ratio}_b \times \text{RA}_{m-1}$ |                                | -0.0263**<br>(0.0110)          | -0.0263**<br>(0.0115)          |
| $\text{Capital Ratio}_b \times \text{RA}_{m-1}$      |                                | -0.202***<br>(0.0696)          | -0.212***<br>(0.0718)          |
| Observations   | 1,013                          | 1,013                          | 1,013                          |
| Number of Banks                                      | 20                             | 20                             | 20                             |
| R-squared  | 0.240                          | 0.249                          | 0.365                          |
| Macro controls & trend                               | yes                            | yes                            | -                              |
| Bank controls  | yes                            | yes                            | yes                            |
| Quarter F.E.   | yes                            | yes                            | -                              |
| Month F.E.   | no                             | no                             | yes                            |
| Bank F.E.  | yes                            | yes                            | yes                            |

NOTES: Regressions are on Panel A. RA is the reserve accumulation measured in 10 billion USD in the balance of payments. Loans and total assets are winsorized at the 0.5 and 99.5 percentiles. All interaction terms are demeaned. A constant is included in every regression but its coefficient is left unreported. Fixed effects and macro controls are either included(yes), not included(no), or spanned by another set of effects(-). Bank controls include log assets, core deposit ratio and capital ratio. Macro controls include inflation, real policy rate and the real exchange rate. The coefficients for these controls are not reported. Regressions are weighted-least squares, where weights are equal to the bank asset size. Standard errors are clustered by bank. \*\*\*, \*\* and \* denote significance at 1%, 5%, 10%, respectively.

Table 1.8: Different Bank Categories

|   | (1)                        | (2)                        | (3)                        | (4)                        |
|---|----------------------------|----------------------------|----------------------------|----------------------------|
|   | $\Delta \ln(\text{loans})$ | $\Delta \ln(\text{loans})$ | $\Delta \ln(\text{loans})$ | $\Delta \ln(\text{loans})$ |
| $RA_{m-1}$                                    | -0.0154***<br>(0.0036)     |                            | -0.0260***<br>(0.0074)     |                            |
| Primary Dealer <sub>b</sub> × $RA_{m-1}$      | -0.0123**<br>(0.0044)      | -0.0121**<br>(0.0045)      |                            |                            |
| Foreign Bank Branch <sub>b</sub> × $RA_{m-1}$ |                            |                            | -0.0552***<br>(0.0054)     | -0.0543***<br>(0.0052)     |
| Nationwide Bank <sub>b</sub> × $RA_{m-1}$     |                            |                            | -0.00989**<br>(0.0041)     | -0.0101**<br>(0.0040)      |
| Observations                                  | 1,013                      | 1,013                      | 1,257                      | 1,257                      |
| Number of Banks                               | 20                         | 20                         | 25                         | 25                         |
| R-squared                                     | 0.248                      | 0.370                      | 0.075                      | 0.113                      |
| Macro controls & trend                        | yes                        | -                          | yes                        | -                          |
| Bank controls                                 | yes                        | yes                        | yes                        | yes                        |
| Quarter F.E.                                  | yes                        | -                          | yes                        | -                          |
| Month F.E.                                    | no                         | yes                        | no                         | yes                        |
| Bank F.E.                                     | yes                        | yes                        | yes                        | yes                        |

NOTES: Columns(1)-(2) are on Panel A and columns (3) and (4) are on Panel B. RA is the reserve accumulation measured in 10 billion USD in the balance of payments. Loans and total assets are winsorized at the 0.5 and 99.5 percentiles. All interaction terms are demeaned. A constant is included in every regression but its coefficient is left unreported. Fixed effects and macro controls are either included(yes), not included(no), or spanned by another set of effects(-). Bank controls include log assets, core deposit ratio and capital ratio. Macro controls include inflation, real policy rate and the real exchange rate. The coefficients for these controls are not reported. Regressions are weighted-least squares, where weights are equal to the bank asset size. Standard errors are clustered by bank. \*\*\*, \*\* and \* denote significance at 1%, 5%, 10%, respectively.

Table 1.9: Elasticity Regressions

|   | (1)                        | (2)                        | (3)                        |
|---|----------------------------|----------------------------|----------------------------|
|   | $\Delta \ln(\text{loans})$ | $\Delta \ln(\text{loans})$ | $\Delta \ln(\text{loans})$ |
| $\ln \text{RA}_{m-1}$                               | -0.0285**<br>(0.0127)      | -0.0292**<br>(0.0110)      |                            |
| $\ln \text{asset}_b \times \ln \text{RA}_{m-1}$     |                            | -0.00483***<br>(0.0012)    | -0.00468***<br>(0.0012)    |
| Core Deposit Ratio $_b \times \ln \text{RA}_{m-1}$  |                            | -0.0162*<br>(0.0083)       | -0.0151*<br>(0.0079)       |
| Capital Ratio $_b \times \ln \text{RA}_{m-1}$       |                            | -0.0940<br>(0.0844)        | -0.0921<br>(0.0834)        |
| Foreign Bank Branch $_b \times \ln \text{RA}_{m-1}$ |                            | -0.0672***<br>(0.0090)     | -0.0658***<br>(0.0089)     |
| Observations  | 1,257                      | 1,257                      | 1,257                      |
| Number of Banks                                     | 25                         | 25                         | 25                         |
| R-squared   | 0.070                      | 0.078                      | 0.114                      |
| Macro controls & trend                              | yes                        | yes                        | -                          |
| Bank controls                                       | yes                        | yes                        | yes                        |
| Quarter F.E.  | yes                        | yes                        | -                          |
| Month F.E.  | no                         | no                         | yes                        |
| Bank F.E.   | yes                        | yes                        | yes                        |

NOTES: The sample period is 2003.9-2008.8. Regressions are on panel B. RA is the reserve accumulation measured in 10 billion USD in the balance of payments. It is rescaled by adding 10 billion USD to every observation for log transformation. Loans and total assets are winsorized at the 0.5 and 99.5 percentiles. A constant is included in every regression but its coefficient is left unreported. Fixed effects and macro controls are either included(yes), not included(no), or spanned by another set of effects(-). Bank controls include log assets, core deposit ratio and capital ratio. Macro controls include inflation, real policy rate and the real exchange rate. The coefficients for these controls are not reported. Regressions are weighted by the bank asset size. Standard errors are clustered by bank. \*\*\*, \*\* and \* denote significance at 1%, 5%, 10%, respectively.

Table 1.10: Placebo Test

|   | (1)                        | (2)                        | (3)                        |
|---|----------------------------|----------------------------|----------------------------|
|   | $\Delta \ln(\text{loans})$ | $\Delta \ln(\text{loans})$ | $\Delta \ln(\text{loans})$ |
| $\Delta \ln ER_{m-1}$                                     | 0.0773<br>(0.0856)         | 0.0818<br>(0.0909)         |                            |
| $\ln \text{asset}_b \times \Delta \ln ER_{m-1}$           |                            | 0.0157<br>(0.0335)         | 0.0155<br>(0.0341)         |
| $\text{Core Deposit Ratio}_b \times \Delta \ln ER_{m-1}$  |                            | -0.0977<br>(0.3163)        | -0.102<br>(0.3272)         |
| $\text{Capital Ratio}_b \times \Delta \ln ER_{m-1}$       |                            | 0.697<br>(1.5388)          | 0.656<br>(1.5885)          |
| $\text{Foreign Bank Branch}_b \times \Delta \ln ER_{m-1}$ |                            | 0.262<br>(0.2724)          | 0.252<br>(0.2659)          |
| Observations  | 1,255                      | 1,255                      | 1,255                      |
| Number of Banks   | 25                         | 25                         | 25                         |
| R-squared   | 0.061                      | 0.062                      | 0.106                      |
| Macro controls & trend                                    | yes                        | yes                        | -                          |
| Bank controls   | yes                        | yes                        | yes                        |
| Quarter F.E.  | yes                        | yes                        | -                          |
| Month F.E.  | no                         | no                         | yes                        |
| Bank F.E.   | yes                        | yes                        | yes                        |

NOTES: The sample period is 2003.9-2008.8. Regressions are on panel B. Loans and total assets are winsorized at the 0.5 and 99.5 percentiles. ER is the KRW/USD exchange rate. All interaction terms are demeaned. A constant is included in every regression but its coefficient is left unreported. Fixed effects and macro controls are either included(yes), not included(no), or spanned by another set of effects(-). Bank controls include log assets, core deposit ratio and capital ratio. Macro controls include inflation, real policy rate and the real exchange rate. The coefficients for these controls are not reported. Regressions are weighted by the bank asset size. Standard errors are clustered by bank. \*\*\*, \*\* and \* denote significance at 1%, 5%, 10%, respectively.



## Chapter 2: Reserve Accumulation and Firm Investment

### 2.1 Introduction

Since the takeoff of foreign reserve hoarding in Asia in the early 2000s, reserve flows have received a substantial amount of attention. Unlike private flows, the size and pace of reserve accumulation is determined by official institutions like central banks. Many studies focus on the intentions of those institutions. However, possible costs associated with reserve accumulation have not been as thoroughly investigated. This paper analyzes the impact of reserve accumulation on domestic investment, which has often been ignored in the literature.

From a practical point of view, foreign exchange reserves are funded by central banks' domestic borrowing. It is well documented in the literature that reserve purchases are almost fully sterilized in most reserve accumulating countries.<sup>1</sup> Table 2.1 provides a stylized central bank balance sheet. Sterilization is offsetting an increase in net foreign assets by increasing liability items other than currency. Most of the heavy reserve accumulating countries rely heavily on issuance of their own securities, which are mostly held by domestic residents. Reserve requirements also

---

<sup>1</sup>Lavigne (2008) reports that emerging Asian countries sterilized most of their reserve accumulation over 2000 to 2006. (Sterilization coefficients: China 0.80, Korea 0.99, Singapore 0.96, Malaysia 0.96) See also Reinhart and Reinhart (2008), Aizenman and Glick (2009), Mohanty and Turner (2006).

play an important role by absorbing liquidity into reserve deposits. In essence, both instruments are central banks' domestic borrowing.

Table 2.1: Central Bank Balance Sheet

| Assets  | Liabilities   |
|---|---|
| <ul style="list-style-type: none"> <li>· Net foreign assets</li> <li>· Net domestic assets</li> </ul> | <ul style="list-style-type: none"> <li>· Currency</li> <li>· Reserve deposits</li> <li>· Central bank securities</li> <li>· Equity</li> </ul> |

If reserves are funded by the central bank's domestic borrowing, then reserve accumulation should have implications for domestic financial markets. Central bank borrowing reduces the remaining loanable funds available for other borrowers, especially firms. It is possible that reserve accumulation has unintended adverse consequences on investment. Figure 2.1 shows international reserves and investment of four East Asian countries from 1990 to 2014. The figure plots gross fixed capital formation relative to GDP(left axis) against the reserve stock(right axis). As can be seen from the graphs, these countries are heavy reserve accumulators. In these countries, a downtrend of investment coincides with reserve accumulation, as seen by the highly negative correlations. It is true that the 1997 Asian financial crisis affected both reserves and investment. However, investment remained depressed even 15 years after the crisis, while reserve hoarding continued.

To better identify the crowding out effect of reserve accumulation, I focus on firm heterogeneity. The financial sector should respond to larger central bank

Figure 2.1: International Reserves and Investment in Selected Asian Countries

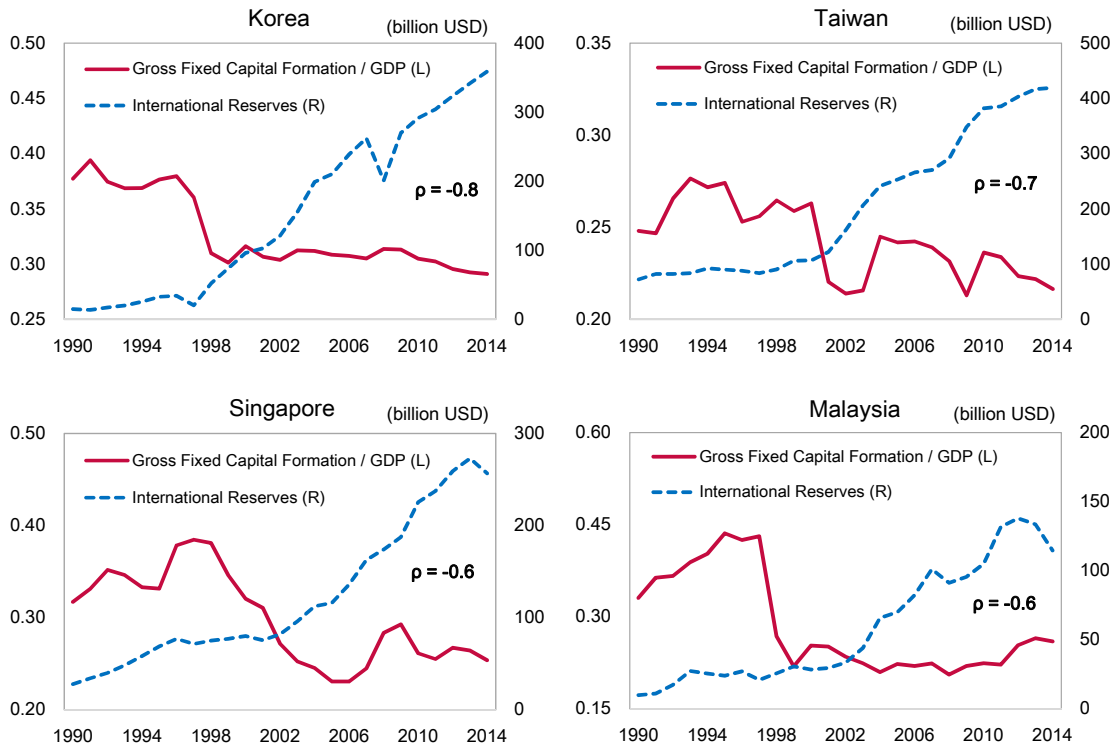

NOTES: The data is from the IMF IFS. The red lines are the gross fixed capital formation to GDP ratio, and they use left axis. The blue dotted lines show the stock of international reserves(right axis).

borrowing by optimally adjusting their portfolio given the risk-return characteristics of assets they hold. Therefore, sterilized reserve accumulation could impact large and small firms differently. Central bank securities are more substitutable with large firms' low-risk, low-return debt securities than small firms' high-risk, high-return debt. After reserve accumulation, financial intermediaries' portfolios are tilted more toward risk-free, low-return central bank securities. This gives the intermediaries more incentive to seek additional yield by taking more risk. If the intermediaries reduce private credit supply to hold more central bank debt, they could reduce

lending to large firms more than lending to small firms. I incorporate this mechanism of differential effects of reserve accumulation on different-sized firms in a theoretical model and find evidence from firm level data.

Figure 2.2 presents evidence on Korean commercial banks' asset allocation over the reserve accumulation period 1996-2007. The top left graph shows the proportion of sterilization bonds in banks' total assets, along with the reserve-GDP ratio. The proportion of sterilization bonds in bank assets increases significantly as reserves are accumulated. The next two graphs show banks' loans to large firms and loans to SMEs in proportion to total assets. The proportion of loans to large firms is negatively correlated with the proportion of sterilization bonds, while the proportion of loans to SMEs is positively correlated. The bottom-right graph shows banks' corporate bond holdings over total assets. Large firms have an ability to issue and sell their own bonds while SMEs mostly rely on bank loans for their external financing. The vast majority of corporate bonds are issued by large firms. The last graph shows that bond holdings are also negatively correlated with banks' holdings of sterilization bonds.

Nevertheless, the existing literature on costs of reserves is mainly focused on direct sterilization costs or the carry costs, meaning the spread of sterilization bonds over the interest earned from reserves. Calvo (1991) first identifies this cost and warns about the sustainability of sterilized intervention. In their study of the optimal level of reserves, Calvo et al. (2012) weigh the cost of reserves using this measure. Rodrik (2006) suggests a similar definition of reserve costs. He calculates the spread between the return on reserves and the cost of the country's foreign borrowing.

Figure 2.2: Bank Credit Allocation

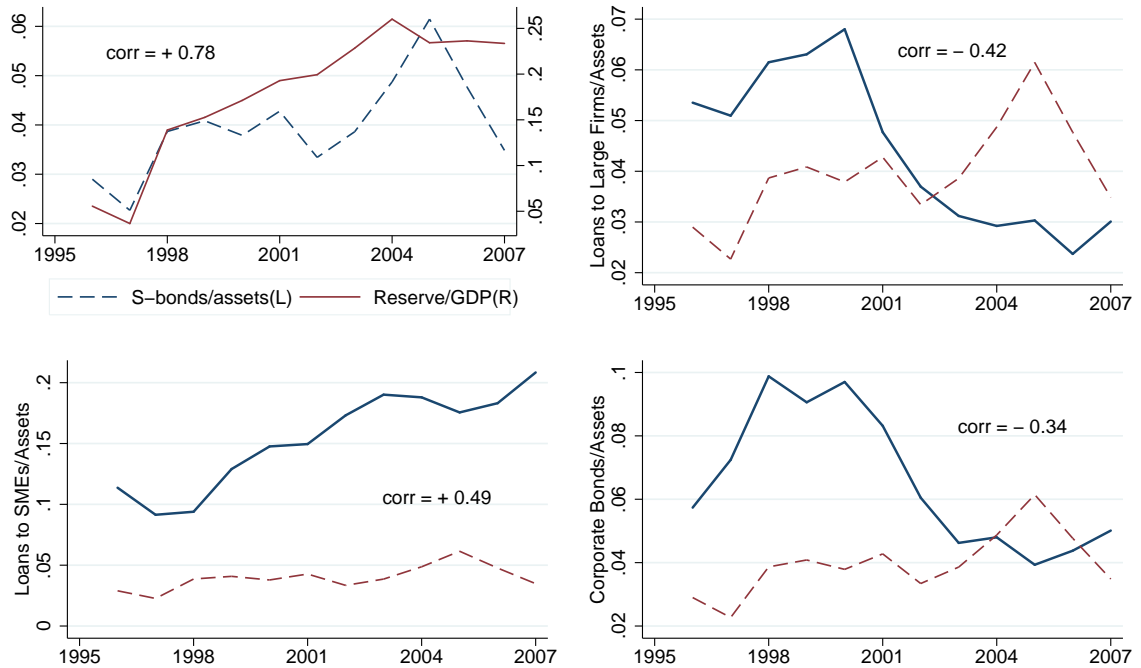

NOTES: The data is sourced from Korea Financial Supervisory Service. The graph shows the sum of all commercial banks, excluding regional banks and government owned banks. The dotted lines show the sterilization bond to total assets ratio in all four panels. The solid lines in each panel show different asset items as indicated at the left axes.

Other possible costs discussed in the literature include negative externalities to neighboring countries and investment crowding out. [Aizenman and Lee \(2008\)](#) argue that reserve accumulation may trigger competitive hoarding in neighboring countries (a keeping up with the Joneses effect). This yields negative externalities which can pre-empt any gains from devaluation made by reserve hoarding. [Reinhart et al. \(2016\)](#) relate the decline of growth rates in Asia after 2000 with reserve accumulation, and raise the possibility that private sector investments have been crowded out by international reserve accumulation. To the best of my knowledge, [Reinhart et al. \(2016\)](#) is the first paper solely devoted to the relationship between reserves and

investment. Their argument is supported by VAR evidence and correlations of aggregate statistics. In contrast, I build a small open economy model and provide micro evidence from Korean firms in this paper.

Existing models of international reserves fail to link reserve hoarding with investment. Focusing on the benefits and motivations of reserve accumulation, they often abstract from production and analyse endowment economies. Some models with production do not have capital (and thus investment), which will be pinned down by the world interest rate. Examples include [Caballero and Panageas \(2005\)](#), [Durdu et al. \(2009\)](#), [Alfaro and Kanczuk \(2009\)](#), [Jeanne and Ranciere \(2011\)](#), and [Benigno and Fornaro \(2012\)](#). By construction, these papers do not find any effect of reserve accumulation on capital or investment. In most of these models, the cost of reserves is just the foregone consumption from saving today. Interestingly, many of these studies document consumption crowding out. It is clear, however, that these models would also have investment crowding out if they had capital and production in their model.

My reading of the reserve accumulation literature leads me to focus on two things in this paper: First, I develop a reserve accumulation model that includes capital and investment. The model demonstrates how reserve accumulation crowds out investment and how it affects large firms more than small firms. Second, I find firm level evidence that supports the model implications. This paper tracks the financial condition of 23,365 Korean firms from 2000 to 2007, using cash sensitivity of investment as a proxy for financial constraints. I find that large firms become 23.8% more constrained after reserve accumulation increases by 1% of GDP, whereas

small firms are not affected. The large firms' investment loss amounts to 0.5% of GDP per every one percent of GDP reserve accumulation.

The remainder of this chapter is organized as follows. Section 2.2 builds a two period small open economy model and shows the differential crowding out effects of reserve accumulation on different sized firms. Section 2.3 provides supporting evidence from Korean firm data. Finally, Section 2.4 concludes.

## 2.2 Theoretical Approach

This section builds a two period model of reserve accumulation. I model reserve accumulation as a central bank borrowing domestically and saving abroad. The benefits and motivations of the central bank for reserve accumulation are beyond the scope of this paper. Instead, I focus on the domestic financial consequences of reserve accumulation. Taking reserve accumulation as exogenously decided from outside the model, I observe what happens to capital and investment of different-sized firms.

There is a small open economy with two sectors, NT(non-tradables) and T(tradables). The non-tradable is the numeraire and the exchange rate  $e_t$  is defined as the tradable price in terms of non-tradables.<sup>2</sup> An increase in  $e_t$  represents SOE currency depreciation. Non-tradable output is used for consumption only. Tradable output is used for consumption, export and investment. Time is discrete and there

---

<sup>2</sup>I abuse the word *currency* to mean a claim to the numeraire of the economy. Outside the small open economy, the tradable is the numeraire. In the SOE, every transaction is denoted in its currency(NT), and world currency(T) is used only in international transactions.

are two periods:  $t = 1, 2$ .

There are five types of private agents: households, non-tradable goods firms, tradable goods firms, domestic financial intermediaries and FX intermediaries. The latter are included in the model to introduce uncovered interest rate parity failure. There are two different types of tradable firms,  $S$ (safe) and  $R$ (risky). There is a unit measure of  $S$  type indexed by  $i \in [0, 1]$ , and another unit measure of  $R$  type indexed by  $j \in [0, 1]$ . In addition, there is a central bank that accumulates foreign exchange reserves by borrowing from the domestic financial intermediary. Figure 2.3 shows flows of funds among agents.

Figure 2.3: Model Outline

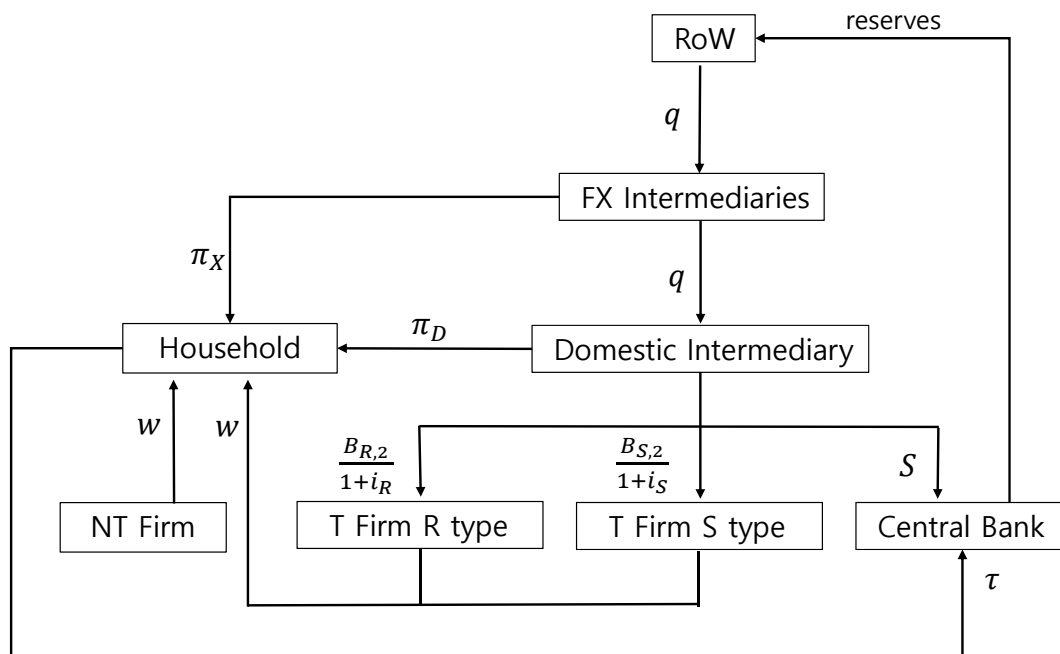



## 2.2.1 Households

There is a representative household which consumes baskets of tradable goods and non-tradable goods (numeraire).  $\chi$  is the weight on non-tradables in the consumption basket. The household inelastically supplies one unit of labor to non-tradable and tradable firms each period, and gets labor income  $w$ . It smooths consumption through the ownership of the domestic financial intermediaries.<sup>3</sup> The household earns profits from the domestic financial intermediaries in each period.  $(\pi_{D,t})$  They also get profits of tradable goods firms  $(\pi_S, \pi_R)$ , and FX intermediaries  $(\pi_X)$  which they own in the second period. Non-tradable good firms always break even, as will be explained later. A lump-sum tax  $\tau$  is also levied in the second period. The household's problem is the following:

$$\max_{\{C_{N,t}, C_{T,t}\}_{t=1,2}} \ln C_1 + \beta \ln C_2 \quad (2.1)$$

$$s.t. \quad C_t \equiv (C_{N,t})^\chi (C_{T,t})^{1-\chi} \quad (2.2)$$

$$C_{N,1} + e_1 C_{T,1} = w_1 + \pi_{D,1} \quad (2.3)$$

$$C_{N,2} + e_2 C_{T,2} = w_2 + \pi_{D,2} + \int_0^1 \pi_{S,i} di + \int_0^1 \pi_{R,j} dj + \pi_X - \tau \quad (2.4)$$

As the intertemporal decision is made by the domestic financial intermediaries on behalf of the household, the household faces intra-temporal choice only. The first order conditions indicates that the household equalizes the marginal utility

---

<sup>3</sup>To focus on what is happening in the local bond market when a central bank accumulates reserves, I assume that the households' intertemporal decisions are made by the domestic financial intermediary, as in [Benigno and Fornaro \(2012\)](#). However, the main mechanism of this model is not affected by households' participation in the bond market.

from spending one unit of local currency in both goods.

$$F.O.C. \quad \frac{\chi}{C_{N,t}} = \frac{1-\chi}{e_t C_{T,t}} = \lambda_t \quad (2.5)$$

$\lambda_t$  denotes the Lagrange multiplier on the budget constraint, which equals the households' marginal utility of wealth. The  $\lambda_t$  are used as intertemporal weights for the profits of the financial intermediaries and tradable good producing firms.

## 2.2.2 Non-tradable Good Firms

Non-tradable goods are assumed to be produced with a technology linear in labor with unit productivity. Hence, the wage is equal to the price of non-tradables:  $w_t = 1$ . The profit of non-tradable firms is zero.

## 2.2.3 Tradable Good Firms

There are two different groups of tradable good producing firms,  $S$  and  $R$ , with a unit measure each.  $S$  type firms are indexed by  $i$ , and  $R$  type firms are indexed by  $j$ . Each group starts with initial capital  $(K_{S,1}, K_{R,1})$  and debt  $(B_{S,1}, B_{R,1})$  owed to the domestic financial intermediaries. This is the same for every firm within each group. All tradable firms share the same decreasing returns Cobb-Douglas production function. In the following description of their problem, I suppress individual

firm subscripts  $i$  and  $j$ .

$$Y = zK^aL^b, \quad a + b < 1 \quad (2.6)$$

The main difference between the two groups is the second period productivity. There are two different states in the second period,  $G$ (good) and  $B$ (bad), with probability  $1 - \psi$  and  $\psi$ , respectively. In a  $G$  state, every firm gets the same productivity  $\bar{z}$ , which is the same as first period productivity. No firm defaults. In a  $B$  state, however,  $\Phi_S$  portion of  $S$  type firms and  $\Phi_R$  portion of  $R$  type firms get  $z = 0$ . If a firm gets zero productivity, it does not produce and defaults on its debt. The financial intermediary, which loaned to the firm in period 1, recovers nothing. All the other firms get  $z = \bar{z}$ .  $\Phi_S$  is smaller than  $\Phi_R$  ( $0 < \Phi_S < \Phi_R < 1$ ), so that the default probability in a  $B$  state is higher in  $R$  type firms than  $S$  type firms. Since  $S$  type firms are less risky, their borrowing rate is lower than  $R$  types in equilibrium. Due to the DRS technology,  $S$  type firms operate at larger scale than  $R$  type firms. Hence, safe firms become large and risky firms become small in the second period.

Labor is chosen after observing productivity and other prices in each period. Hence, the optimal labor demand equates the marginal product of labor with the wage rate:

$$\begin{aligned} VMPL_t &= e_t b z K_t^a L_t^{b-1} = 1 = w_t \\ L_t &= [e_t b z K_t^a]^{-\frac{1}{1-b}} \end{aligned} \quad (2.7)$$

Once the firms choose labor, their profit after production for the first period is realized as:

$$\begin{aligned}\pi_1 &= e_1 Y_1 - L_1 - B_1 \\ &= \frac{1-b}{b} (e_1 b z K_1^a)^{\frac{1}{1-b}} - B_1\end{aligned}\tag{2.8}$$

Therefore, the tradable firms have no control over their first period profit. Their problem is to maximize the second period profit by optimally choosing investment and borrowing.

Firms own capital and augment it through investment. One unit of tradable good is converted to one unit of capital, and the conversion is irreversible. Firms can borrow only from the domestic financial intermediary. We assume that internal funds (first period profits) are not enough to fund firms' investment, so that firms need to borrow from the domestic intermediary. Firms pay only the second period profits to the household. The first period profit, if any, is used solely for investment. In the first period, they solve the following problem of maximizing the expected second period profit:

$$\max_{B_2, L_2} E\{\lambda_2 \pi_2\} = E\{\lambda_2 (e_2 Y_2 - L_2 - B_2)\}\tag{2.9}$$

$$s.t. \quad e_1 (K_2 - K_1) = \frac{B_2}{1+i} + \pi_1\tag{2.10}$$

where  $i$  is the ex-ante promised interest rate on borrowing.  $i$  will be different for each type of firm in equilibrium. Note that the firms maximize according to household's

discount factor  $\lambda_2$ .<sup>4</sup> Firms' investment decision is characterized by the following first order condition.

$$E \left\{ \lambda_2 \left( \frac{a}{b} (e_2 b z)^{\frac{1}{1-b}} K_2^{\frac{a+b-1}{1-b}} - (1+i)e_1 \right) \right\} = 0 \quad (2.11)$$

Equation (2.11) determines the optimal scale of each firm in the second period.

## 2.2.4 Domestic Financial Intermediary

A representative domestic financial intermediary starts period 1 with initial funds  $\int_0^1 B_{S,1} di + \int_0^1 B_{R,1} dj = B_{S,1} + B_{R,1}$ . It borrows  $q$  from the FX intermediary at risk free interest rate  $R_f$ , and buys debt issued by firms and also the central bank. The intermediary yields profits to the household each period. It maximizes its discounted sum of profits as follows:

$$\max_{q, S, X_S, X_R} \quad \pi_{D,1} + E \beta \frac{\lambda_2}{\lambda_1} \pi_{D,2} \quad (2.12)$$

$$s.t. \quad \pi_{D,1} + S + X_S + X_R = B_{S,1} + B_{R,1} + q \quad (2.13)$$

$$\pi_{D,2} = R_f(S - q) + R_S X_S + R_R X_R \quad (2.14)$$

$S$  is the quantity of central bank debt bought by the intermediary, while  $X_S$ ,  $X_R$  are bonds from each type of firm. Within each group, firms are ex-ante identical, and

---

<sup>4</sup>Firms need household's discount factor to weigh between the profit in good state and the profit in bad state. Therefore, period 2 marginal utility is used. Using  $\frac{\beta \lambda_2}{\lambda_1}$  as the weight does not make any difference, since the firms do not have control over its first period profit and yield only second period profit to the households.

their bonds are also identical. The central bank's debt and the domestic financial intermediary's debt are identical in the sense that both have no risk. Their interest rates are the same in equilibrium and I denote this risk free rate as  $R_f$ . The realizations of  $R_S$  and  $R_R$  depend on the period two state:

$$R_S = \begin{cases} (1 + i_S), & \text{if } \mathbf{S}=G. \\ (1 - \Phi_S)(1 + i_S), & \text{if } \mathbf{S}=B. \end{cases} \quad R_R = \begin{cases} (1 + i_R), & \text{if } \mathbf{S}=G. \\ (1 - \Phi_R)(1 + i_R), & \text{if } \mathbf{S}=B. \end{cases}$$

In equilibrium the ex-post return of  $S$  type bonds is lower than  $R$  type bonds in state  $G$ , and is higher than  $R$  type in state  $B$ . Since  $R$  type firms have riskier technology, their promised interest rate  $i_R$  is higher in equilibrium than  $i_S$  ( $i_S < i_R$ ). Therefore, in  $G$  state where no firms default, the return is higher in the  $R$  group. Then, the overall return in  $B$  state must be higher for the  $S$  type, since otherwise no one will buy debts issued by  $S$  type firms. ( $(1 - \Phi_R)(1 + i_R) < (1 - \Phi_S)(1 + i_S)$ ) Hence, the  $S$  type bond yields better in the bad state, and worse in the good state compared to the  $R$  type bond.

The optimality conditions for the domestic intermediary are Euler equations:

$$1 = E \left\{ \frac{\beta \lambda_2}{\lambda_1} \right\} R_f \quad (2.15)$$

$$1 = E \left\{ \frac{\beta \lambda_2}{\lambda_1} R_S \right\} \quad (2.16)$$

$$1 = E \left\{ \frac{\beta \lambda_2}{\lambda_1} R_R \right\} \quad (2.17)$$

Note that the risk-free rate  $R_f$  is not state contingent, and it is outside the expec-

tation operator in Eq.(2.15).

## 2.2.5 FX Intermediaries

The role of the foreign exchange intermediaries in this model is to break Ricardian equivalence. FX intermediaries borrow from abroad in foreign currency and lend to the domestic financial intermediary in domestic currency. In a frictionless economy, the FX intermediaries will perfectly undo the central bank's action in the international capital market as pointed out in [Backus and Kehoe \(1989\)](#). I deviate from the frictionless world by imposing a limit to the amount a FX intermediary can channel to the SOE. This is similar to [Gabaix and Maggiori \(2015\)](#), [Fanelli and Straub \(2016\)](#) and [Amador et al. \(2016\)](#).

There is a continuum of FX intermediaries. They are labeled by  $\alpha \in [0, \infty)$ . Each intermediary is subject to a net open position limit  $X$ , and faces participation costs. The FX intermediary  $\alpha$  active in the domestic bond market is obliged to pay fixed cost of exactly  $\alpha$ . The FX intermediary  $\alpha$  chooses how much to invest ( $x_\alpha$ ) in domestic bonds by solving:

$$\begin{aligned} \max \quad & E \left( R_f - R^* \frac{e_2}{e_1} \right) x_\alpha - 1_{\{x_\alpha \neq 0\}} \alpha \\ \text{s.t.} \quad & x_\alpha < X \end{aligned}$$

where  $R^*$  is the world interest rate by which the intermediary funds its investment. The objective function is linear in  $x_\alpha$ , hence whenever  $x_\alpha$  is positive, it would be the

maximum amount  $X$ . All intermediaries with  $\alpha \leq E\left(R_f - R^* \frac{e_2}{e_1}\right) X$  would invest  $X$ . Then the total foreign capital flow into the domestic bond market is:

$$q = E\left(R_f - R^* \frac{e_2}{e_1}\right) X \cdot X$$

Define  $\Gamma = X^{-2}$ . Then

$$q = E\left\{\frac{1}{\Gamma}\left(R_f - R^* \frac{e_2}{e_1}\right)\right\} \quad (2.18)$$

The parameter  $\Gamma$  governs the degree of financial openness. If  $\Gamma = 0$  or  $X = \infty$ , then there is no limit in the capacity of individual FX intermediaries, and uncovered interest rate parity holds. If  $\Gamma = \infty$  ( $X = 0$ ), then the private sector cannot borrow or lend from the international market and the economy is in financial autarky. I assume that the fixed costs are paid to each other and that  $\theta$  portion of the intermediaries are owned by domestic households, while  $1 - \theta$  are owned by RoW. Then, the profit yielded to the households is:

$$\pi_X = \theta\left(R_f - R^* \frac{e_2}{e_1}\right)q \quad (2.19)$$

## 2.2.6 Central Bank

The central bank issues debt  $S$  in domestic currency and exchanges the proceeds for foreign currency  $F = S/e_1$ .  $F$  is the stock of reserves, and the central bank saves  $F$  abroad at the world interest rate  $R^*$ .  $F$  is exogenously decided. To



close the model, the central bank brings back the reserves  $R^*e_2S/e_1$  from abroad and pays back the debt  $R_fS$  in the second period. There could be a gap between the central bank's assets and liabilities in period two due to interest rate differentials and exchange rate variation. To recover its fiscal loss, it levies a lump-sum tax  $\tau$  on households in the second period:

$$\tau = \left( R_f - R^* \frac{e_2}{e_1} \right) S \quad (2.20)$$

### 2.2.7 Equilibrium

There are total five markets to be cleared in equilibrium.

- Labor market:

$$L_{N,t} + \int_0^1 L_{S,t} di + \int_0^1 L_{R,t} dj = 1 \quad (2.21)$$

- Non-tradable goods market:

$$C_{N,t} = L_{N,t} \quad (2.22)$$

- Risk free bond issued by domestic financial intermediary:

$$q^D = q^S \quad (2.23)$$

I use the same letter  $q$  for both FX intermediaries' choice of lending and the domestic intermediary's choice of borrowing, but they are actually indepen-

dently chosen by the two types of intermediaries and equalized at equilibrium.

- Risky bonds issued by firms:

$$\frac{B_{S,2}}{1+i_S} = X_S \quad (2.24)$$

$$\frac{B_{R,2}}{1+i_R} = X_R \quad (2.25)$$

- FX market:

$$\underbrace{e_1\{Y_{S,1} + Y_{R,1} - (K_{S,2} - K_{S,1}) - (K_{R,2} - K_{R,1}) - C_{T,1}\}}_{\text{Net Exports}} + \underbrace{q - S}_{\text{Portfolio Flows}} = 0 \quad (2.26)$$

$$\underbrace{e_2\left(\int_0^1 Y_{S,2} di + \int_0^1 Y_{R,2} dj - C_{T,2}\right)}_{\text{Net Exports}} + \underbrace{\left[\theta \left(R_f - R^* \frac{e_2}{e_1}\right) - R_f\right] q + \frac{e_2}{e_1} R^* S}_{\text{Portfolio Flows}} = 0 \quad (2.27)$$

The FX market clearing conditions are the resource constraints of this economy. The conditions are derived by combining the budget constraints of households and firms. Expressed in domestic currency, they mean that net demand for SOE currency against foreign currency has to be zero in each period. The net demand has two components: net exports and portfolio flows. The equilibrium exchange rate is determined to clear demand and supply of domestic currency.

Using the constraints and equilibrium conditions, a competitive equilibrium can be defined as follows.

### Equilibrium Definition<sup>5</sup>

A competitive equilibrium is defined as a set of allocations  $(\pi_X, \tau, q, K_{S,2}, K_{R,2}, B_{S,2}, B_{R,2}, X_R, X_S, \{C_{N,t}, C_{T,t}, L_{N,t}, L_{S,t}, L_{R,t}, \pi_{D,t}\}_{t=1,2})$  and a price system  $(R_f, i_S, i_R, \{\lambda_t, e_t\}_{t=1,2})$  that satisfy equations (2.3)-(2.5), (2.7), (2.9)-(11), (2.13)-(2.22), (2.24)-(2.27), given exogenous policy  $S$  and the initial conditions  $(K_{S,1}, K_{R,1}, B_{S,1}, B_{R,1})$ .

### 2.2.8 Effect of Reserve Accumulation

This subsection illustrates the effect of reserve accumulation and explains the mechanism by providing a numerical solution to the model. First, Table 2.2 shows the model parameterization. The time discount factor  $\beta$  is set to be compatible with an annual interest rate of 5%. The output elasticities of capital and labor ( $a$  and  $b$ ) are taken from the capital share and labor share of the 2005 Korean input-output table. They do not sum to one as the total value added consists of capital share(operating surplus and depreciation), labor share(wage) and tax.  $\psi$  is 0.5 so that the probabilities of boom and bust are even. In a bad state, the default rate of  $S$  type firms is set to 1%, while it is 10% for  $R$  type firms. The financial openness parameter  $\Gamma = 0.1$  is from Gabaix and Maggiori (2015).<sup>6</sup>  $\theta$  is chosen to be zero, so all the FX intermediaries are owned by foreigners and their profits do not flow into the SOE. Changing  $\theta$  to one, however, does not change the results qualitatively.

---

<sup>5</sup>Note that some equations should be counted two or four times for the two time periods and two types of tradable firms. The number of equations and unknowns exactly match.

<sup>6</sup>They document that the number is “in broad congruence with the experience of Israel and Switzerland during the recent financial crisis.”

Table 2.2: Parameters and Initial Conditions

---

| <b>Parameters</b>         |  |      |
|---------------------------|--|------|
| $\chi$                    | non-tradable goods preference                                | 0.50 |
| $\beta$                   | time discount factor   | 0.95 |
| $a$                       | output elasticity of capital                                 | 0.43 |
| $b$                       | output elasticity of labor                                   | 0.47 |
| $\bar{z}$                 | total factor productivity                                    | 1.40 |
| $\psi$                    | probability of Bad state                                     | 0.50 |
| $\Phi_S$                  | default rate of S-type firms                                 | 0.01 |
| $\Phi_R$                  | default rate of R-type firms                                 | 0.10 |
| $R^*$                     | gross world interest rate                                    | 1.00 |
| $\Gamma$                  | degree of financial openness                                 | 0.10 |
| $\theta$                  | portion of FX intermediaries<br>owned by domestic households | 0.00 |
| <b>Initial Conditions</b> |  |      |
| $K_{S,1}$                 | initial capital stock of $S$ type firms                      | 0.09 |
| $K_{R,1}$                 | initial capital stock of $R$ type firms                      | 0.09 |
| $B_{S,1}$                 | initial debt of $S$ type firms                               | 0.20 |
| $B_{R,1}$                 | initial debt of $R$ type firms                               | 0.20 |

---

The firm size is determined in the second period according to the riskiness of their technology, and initial capital only matters for the first period aggregate output. Therefore, I do not differentiate the initial capital of  $S$  type and  $R$  type firms. The initial capital was chosen to get a reasonable range of equilibrium interest rates.

Given an amount of exogeneously chosen reserves  $F(= S/e_1)$ , I can calculate the equilibrium numerically. To see the effect of reserve accumulation, I com-

pare equilibria with different amount of reserve accumulation. Below, I calculate equilibria with 11 different levels of reserves ranging from zero to 0.1 in foreign currency. The GDP measured in foreign currency when there is no reserve accumulation ( $F = 0$ ) is 0.84, hence reserve accumulation of 0.1 roughly corresponds to 12% of GDP.

Figure 2.4: Exchange Rate and Trade Balance

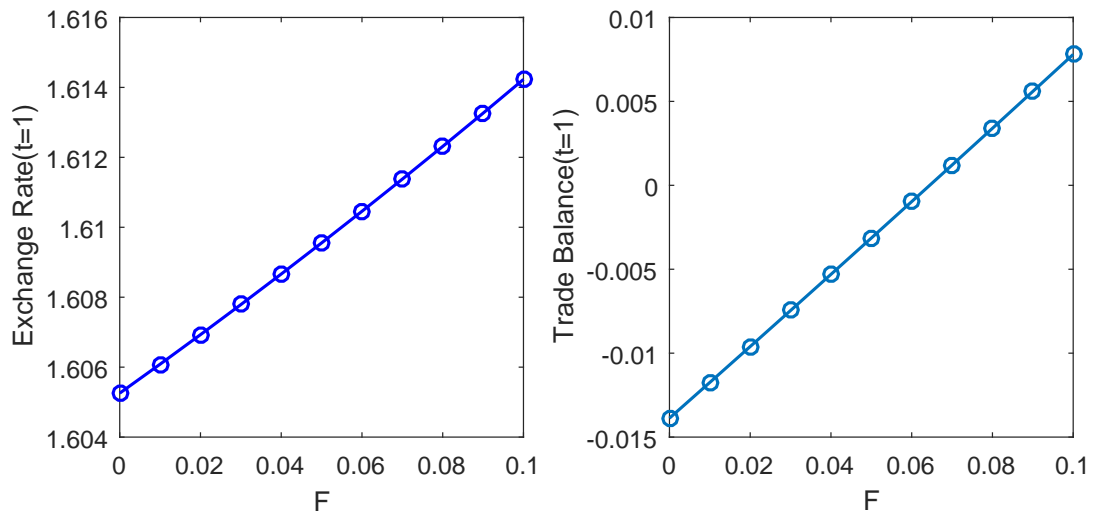

Figure 2.4 shows the equilibrium exchange rates and trade balances as functions of reserve accumulation. The left panel shows the first period exchange rate. As the quantity of reserves  $F$  increases, the exchange rate rises (depreciates). The intervention depreciates exchange rate because the central bank supplies local currency while demanding foreign currency in the FX market, and the private sector cannot fully offset the central bank's action.<sup>7</sup> The right panel shows that trade balance in period 1 improves with reserve accumulation. Tradable goods become more

<sup>7</sup>Adler et al. (2015) discuss the theoretical background and provide empirical evidence on the effects of FX intervention on exchange rate.

expensive due to reserve accumulation and the household consumption switches toward non-tradable goods. As a consequence, net exports increase. Promoting exports is thought to be one of the main reasons for reserve accumulation, although it is not explicitly modeled as a motivation here.

Figure 2.5: Ricardian Equivalence Failure

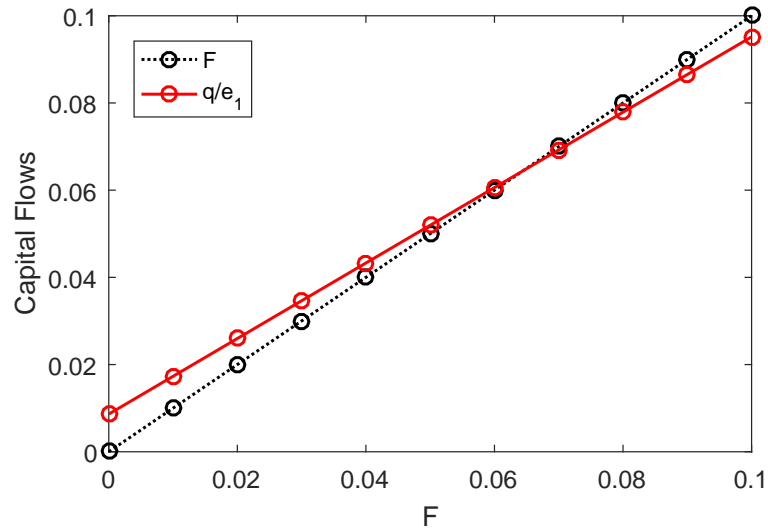

Figure 2.5 shows portfolio capital flows. The black dotted line shows FX reserve accumulation from zero to 0.1. It is a 45 degree line. The solid red line shows the private borrowing from abroad. As reserve accumulation increases, the private Ricardian response is to borrow more from abroad. As the UIP gap increases, the private capital inflow does increase. Because of the friction in international capital intermediation, however, the additional borrowing of the private sector does not fully offset the public outflows in the form of reserves. Therefore, the slope of private inflow is less than one in the graph above. In this numerical example, reserve flows outweigh private inflows after reserve accumulation exceeds 0.06.

Figure 2.6: Equilibrium Interest Rates

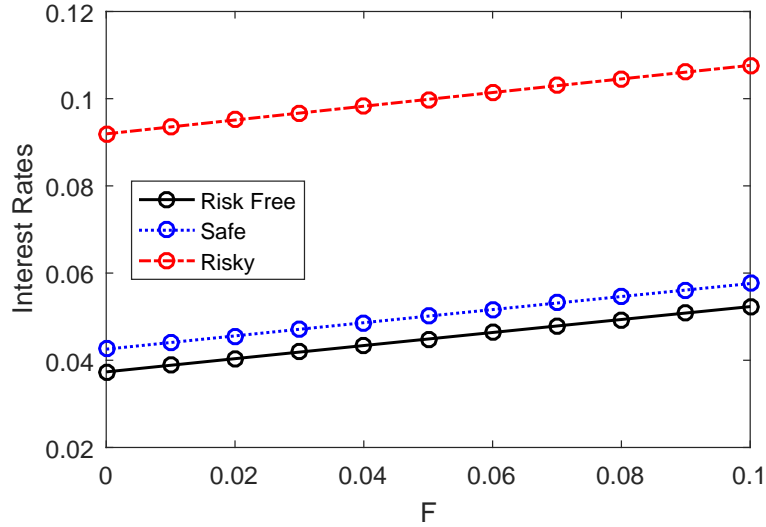
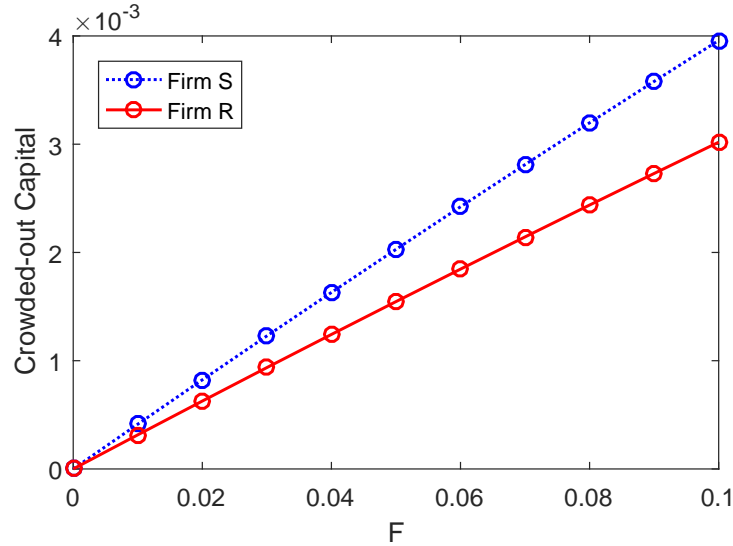

Figure 2.6 shows the equilibrium interest rates. The solid black line is the risk free rate. Starting around 0.04, it increases as reserve accumulation increases. The interest rate paid by  $S$  type firms is shown by the blue dotted line and is a little higher than the risk free rate, as the bonds of  $S$  type firms involve some risk. The interest rate for  $R$  type firms is much higher as shown in the red dashed line. Firm size in the second period is determined by the interest rates they pay. Paying a lower interest rate,  $S$  type firms invest more and become large firms, while  $R$  type firms become small.

Finally, Figure 2.7 shows the main result of differential crowding out effects on different-sized firms. It presents the amount of capital crowding out of  $S$  type firms and  $R$  type firms. The lines show the gap between the capital stock with no reserve accumulation and the capital stock with the level of reserve accumulation plotted on the horizontal axis. The blue dotted line is for  $S$  type firms, and the solid red line is for  $R$  types. As reserve accumulation increases, the reduction in capital stock

also increases in both types of firms.

Figure 2.7: Crowded-out Capital



The most important result is that the crowding out line is steeper for  $S$  type firms (large firms) than for  $R$  type firms (small firms). Large firms' bonds are more similar to the risk-free sterilization bonds issued by the central bank in two dimensions, expected return and variance of the return. When there is a higher supply of sterilization bonds, accompanied by a higher risk-free rate, the optimal response of the domestic financial intermediary is to reduce its holdings of large firms' bonds more than small firms, and to hold more risk-free bonds. The model predicts that large firms' investment and capital are crowded out more than small firms by reserve accumulation.

Although fairly stylized, with only two periods, this model has several characteristics different from existing models of reserve accumulation. First, by having capital and production, this model can analyze the effect of reserve accumulation



on investment. Most existing reserve accumulation models are built to explain the motivations or benefits of accumulating reserves, so that they either abstract from production and analyze endowment economies, or do not have capital, which would be pinned down by the world interest rate in a small open economy setup.

Second, this model can illustrate the empirical findings of [Alfaro et al. \(2014\)](#) that private capital inflows are dominated by much larger public outflows in reserve accumulating countries. By incorporating segmented international markets, as in [Gabaix and Maggiori \(2015\)](#) and [Fanelli and Straub \(2016\)](#), in a small open economy setup, the model of this chapter shows that public outflows and private inflows exist together, and that public outflows induce additional private inflows that offset the initial outflows only partially. This feature cannot be achieved with a brute-force borrowing constraint.

Third, this model shows that policy effects can be different across heterogeneous firms. Reserve accumulation reduces available credit. The increased access to safe central bank assets allows financial intermediaries to take more risk and thus increase their lending to riskier debtors. The model shows that credit to small firms is reduced by less than to large firms. The heterogeneous sensitivities of firms yields an important testable hypothesis which will be examined in the next section.

## 2.3 Empirical Evidence

This section tests how reserve accumulation affects financial constraints of different-sized firms in Korea. Section 2.3.1 reviews the testing framework and related literature. Section 2.3.2 derives the regression equation. Section 2.3.3 describes the data used, and Section 2.3.4 checks the performance of the testing framework by replicating previous literature using the Korean data. Section 2.3.5 documents the main findings, and Section 2.3.6 does a counterfactual exercise using the main results. Section 2.3.7 checks robustness of the finding in a dynamic panel regression setting. The last section 2.3.8 supports the main findings by investigating firms' interest rates.

### 2.3.1 Testing Framework

Firm financial constraints ultimately come from information asymmetries and agency problems. In a frictionless Modigliani-Miller world, there is no difference in the cost of internal financing and external financing. When frictions exist, however, external financing becomes more costly than internal financing, so that firms are financially constrained. Relying on this foundation, one can measure firms' financial constraints by examining how sensitive investment is to internal funds. If a firm is not constrained, its investment would not depend on internal funds per se, since firms with good investment opportunities can easily switch to external financing to fund the investments. Conversely, if a firm is financially constrained, then internal funds

would have explanatory power for its investment even controlling for fundamental factors affecting optimal frictionless investment.

The idea of using the investment-cash flow sensitivity as a proxy for firm financial constraints was first proposed by [Fazzari et al. \(1988\)](#) and it soon created a large literature. [Fazzari et al. \(1988\)](#) and other related papers find a positive relationship between investment and cash flow in financially constrained firms, identified in various ways. While many studies use variations of this methodology to gauge firm financial constraints, another group of studies questions the validity of this approach. [Kaplan and Zingales \(1997\)](#) show that investment-cash flow sensitivities do not increase monotonically with the degree of financing constraints. [Gomes \(2001\)](#) and [Alti \(2003\)](#) emphasize other important factors that determine firm investment such as Tobin's  $q$  or growth rates and argue that mis-measurement of those factors can result in spurious correlation between cash flow and investment. Most recently, using U.S. firm data, [Farre-Mensa and Ljungqvist \(2015\)](#) find that the cash flow sensitivity measure, along with four other measures, does not identify firms that behave as if they were constrained.

Despite the controversy, many empirical studies identify firm financial constraints via the investment-cash sensitivity and establish findings that are in line with other independent studies.<sup>8</sup> [Love \(2003\)](#) finds that firms in financially developed countries exhibit lower investment-cash sensitivity than firms in less developed financial markets. [Laeven \(2003\)](#) shows that financial liberalization lowers the

---

<sup>8</sup>For example, [Chen and Chen \(2012\)](#) report that many studies are using investment cash flow sensitivity despite the controversy, although they themselves find that the sensitivity declined and disappeared over time.

investment-cash sensitivity of small firms. [Harrison et al. \(2004\)](#) finds that global capital flows reduce the investment-cash sensitivity of firms. Similarly, [Forbes \(2007\)](#) shows that Chilean capital controls made small firms more financially constrained. She shows that small firms have higher investment-cash sensitivity than large firms, and that small firms' investment-cash sensitivity rose significantly during periods of capital controls. More recently, [Erel et al. \(2015\)](#) use the sensitivity of investment to cash flow, along with other measures of financial constraints, to show that acquisitions relieve financial frictions in target firms, using European firm data.

As will be shown later in this section, using the sample of Korean firms, I also find that small firms have larger investment-cash sensitivity than large firms, and that investment-cash sensitivity fell significantly after the opening of Korea's financial markets. Hence, recognizing the limitations, I proceed to interpret the cash sensitivity of investment as a proxy of financial constraints.

Standard investment regressions in previous literature are built on Tobin's  $q$  theory. The  $q$  theory, however, has many empirical problems. First, usually the average  $q$  is used instead of unobservable marginal  $q$ . It is the marginal  $q$  that determines firm investment, and the marginal  $q$  is equal to average  $q$  only in very restrictive cases. Second, one needs stock market valuations to measure average  $q$ , so it is not feasible to get  $q$  for unlisted firms. Third, even for listed firms, it is likely that average  $q$  is mis-measured from stock price data. Stock market valuation is not a reliable measure of average  $q$  if the financial market is not well developed or if the market for that stock is not thick enough. For these reasons, many recent papers dispense with  $q$  theory and directly estimate the investment Euler equation, rather

than the first order condition that contains marginal  $q$ . The goal of this paper is to contrast large firms with small firms during periods of reserve accumulation. The data used in this paper has many unlisted small firms, so I follow the Euler equation approach.

In the following, I use the Euler equation framework and infer that firms are financially constrained if their investment is sensitive to their cash holdings after controlling for profitability. I test whether firm financial constraints are associated with fluctuations of reserve accumulation and investigate whether this association is stronger for large versus small firms.

### 2.3.2 Regression Equation

The following derivation of the central estimating equation closely follows [Harrison et al. \(2004\)](#) and [Forbes \(2007\)](#). Suppose a firm maximizes the expected sum of dividends subject to constraints.

$$V_t(K_t, \zeta_t) = \max_{\{I_{t+s}\}_{s=0}^{\infty}} D_t + E_t \left[ \sum_{s=1}^{\infty} \beta_{t+s-1} D_{t+s} \right] \quad (2.28)$$

$$s.t. \quad D_t = \Pi(K_t, \zeta_t) - I_t - C(I_t, K_t) \quad (2.29)$$

$$K_{t+1} = (1 - \delta)K_t + I_t \quad (2.30)$$

$$D_t \geq 0 \quad (2.31)$$

$K_t$  is the capital stock at  $t$ ,  $D_t$  is the dividend,  $\zeta_t$  is the productivity shock,  $\Pi(K_t, \zeta_t)$  is a profit function, and  $C(I_t, K_t)$  is an adjustment cost function. The constraint

(2.31) prevents external financing. Let  $\lambda_t$  be the multiplier for this constraint. Then  $\lambda_t$  measures the shadow price of external financing. The first order condition and envelope condition are derived as follows.

$$\frac{\partial V_t}{\partial I_t} = - \left( \frac{\partial C_t}{\partial I_t} + 1 \right) (1 + \lambda_t) + E_t \beta_{t+1} \frac{\partial V_{t+1}}{\partial K_{t+1}} = 0 \quad (2.32)$$

$$\frac{\partial V_t}{\partial K_t} = \left( \frac{\partial \Pi_t}{\partial K_t} - \frac{\partial C_t}{\partial K_t} \right) (1 + \lambda_t) + E_t \beta_{t+1} (1 - \delta) \frac{\partial V_{t+1}}{\partial K_{t+1}} = 0 \quad (2.33)$$

One can estimate Eq.(2.32), if there is a proxy for  $q(= \partial V/\partial K)$ . For the reasons mentioned previously, I instead derive an Euler equation that does not have  $q$  in it. Combining (2.32) and (2.33), one gets the following optimality condition for this problem:<sup>9</sup>

$$1 + \frac{\partial C_t}{\partial I_t} = \beta E_t \frac{1 + \lambda_{t+1}}{1 + \lambda_t} \left[ \frac{\partial \Pi_{t+1}}{\partial K_{t+1}} + (1 - \delta) \left( \frac{\partial C_{t+1}}{\partial I_{t+1}} + 1 \right) \right] \quad (2.34)$$

$\lambda_t$  is the shadow cost of external financing and  $(1 + \lambda_{t+1})/(1 + \lambda_t)$  is the relative shadow cost of external financing in  $t + 1$  versus  $t$ . This can be used as a measure of financial constraints. If financial markets are complete, then  $\lambda_t = \lambda_{t+1}$  and the term becomes one. If  $\lambda_t > \lambda_{t+1}$ , however, the shadow cost of external financing is higher today than tomorrow, which means that the firm is financially constrained today. We assume that  $(1 + \lambda_{t+1})/(1 + \lambda_t)$  is described as a function of firm specific constraints and the cash-capital ratio at the end of the previous period. To see

---

<sup>9</sup> $\partial C/\partial K$  is a second order effect and I set this to be zero as in [Harrison et al. \(2004\)](#) or [Forbes \(2007\)](#).

whether financial constraints are affected by reserve accumulation, we let the impact of the cash-capital ratio vary with reserve accumulation:

$$\frac{1 + \lambda_{t+1}}{1 + \lambda_t} = \psi_{0,i} + (\psi_1 + \psi_2 \mathbf{res}_{t-1}) \frac{\mathbf{cash}_{i,t-1}}{K_{i,t-1}} \quad (2.35)$$

where  $\mathbf{res}$  is reserve accumulation / GDP. Since it would take time for reserve accumulation to affect firm investment through financial markets,  $\mathbf{res}$  is lagged by one year. To test whether the effect is different for different sized firms, the specification can be adjusted as follows:

$$\frac{1 + \lambda_{t+1}}{1 + \lambda_t} = \psi_{0,i} + (\psi_1 d_L + \psi_2 + \psi_3 d_L \cdot \mathbf{res}_{t-1} + \psi_4 \mathbf{res}_{t-1}) \frac{\mathbf{cash}_{i,t-1}}{K_{i,t-1}} \quad (2.36)$$

where  $d_L$  is a dummy variable for being large.

To get the estimating equation, I must specify the forms of the adjustment cost function and MPK. I assume a standard quadratic adjustment cost function as below:

$$C(I_{it}, K_{it}) = \frac{1}{2\alpha_1} \left[ \frac{I_{it}}{K_{it}} + \alpha_i + \alpha_t \right]^2 K_{it} \quad (2.37)$$

For the MPK, I assume a Cobb-Douglas production function and estimate MPK using the sales to capital ratio.

After substituting Eq.(2.35) into the optimality condition (2.34), I assume rational expectations which allows expected values to be estimated using realized values. I use  $\mathbf{sales}_{t-1}$  rather than  $\mathbf{sales}_t$  to avoid simultaneity. Taking first order

Taylor approximation, one gets the following estimating equation.

$$\left(\frac{I_{i,t}}{K_{i,t-1}}\right) = f_i + d_t + \theta_1 \left(\frac{\text{cash}}{K}\right)_{i,t-1} + \theta_2 \left(\frac{\text{sales}}{K}\right)_{i,t-1} + \theta_3 \text{res}_{t-1} \left(\frac{\text{cash}}{K}\right)_{i,t-1} + \epsilon_{it} \quad (2.38)$$

### 2.3.3 Data

Korea is the world's seventh-largest holder of FX reserves. As of December 2015, Korea held 368.0 billion USD, which amounted to 26.7% of its GDP. At the beginning of the 1997 financial crisis, however, it was holding only 20.4 billion USD, 3.7 % of GDP. Figure 2.8 shows the trend of Korea's reserve holdings. The bulk of the reserve was accumulated during the period 1999-2007. During this period, Korea increased its reserve stock from 52.0 to 262.2 billion USD, and the reserve-GDP ratio rose from 13.9% to 23.4%.

Figure 2.8: Reserve Accumulation of Korea

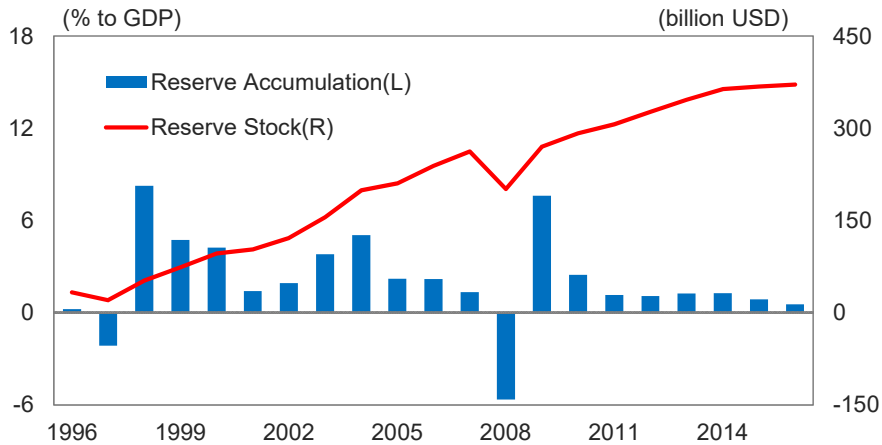

NOTES: The data is from the Bank of Korea. The line shows stock of international reserves(right axis). The bar graph shows annual transaction of reserve assets(left axis).



Therefore, Korea in 1999-2007 provides a useful laboratory to study the effects of reserve accumulation on private investment. Avoiding two financial crises (the 1997 Asian crisis and the 2008 global crisis), I focus on the time window between 1999 and 2007.

For the measure of reserve accumulation, I use data from the balance of payment (BOP) statistics. BOP measures international transactions. The “Reserve Assets” item in BOP measures the change in the reserves stock caused by transactions. It excludes the effects of asset price changes or exchange rate variation, so it is suitable for the purpose of this study. On average, Korea accumulated 3.2% of its GDP as reserves each year during the sample period. It accumulated reserves to varying degrees over this sample period; in 2001 reserve accumulation was 1.4% of GDP, whereas it was 5.1% in 2004. Thus, this period provides good variation in reserve accumulation.

The firm data comes from annual financial statements, and covers approximately all Korean corporations whose asset size is larger than 10 million USD. Those firms are obliged to report annual statements to the public. Most of the variables used in the following analysis come from balance sheets and cash flow statements. The data covers only those firms which are still operating. Firms in the financial sector or the public sector are excluded from the sample. I also exclude firms with only one employee and firms whose book closing month is not December. To control for outliers, I delete observations with unrealistic values, and winsorize key variables. Details about the sample selection procedure are described in Appendix B. After these restrictions, there remain 23,365 firms in the dataset.

Variable definitions are in Table 2.3. Sector indicators are built based on the KSIC(Korean Standard Industrial Classification) and there are 40 sectors. Details are provided in Table B.1 of Appendix B.

Table 2.3: Variable Definitions

| Variable             | Code         | Definition  |
|----------------------|--------------|---|
| Reserve accumulation | <b>res</b>   | $( \text{net reserve purchase} / \text{GDP} ) \times 100$                                       |
| Capital              | $K$          | tangible capital  |
| Investment           | $I$          | net purchase of non-financial assets  |
| Cash holding         | $C$          | cash and cash equivalent  |
| Sales                | $S$          | sales   |
| Firm interest rate   | <b>ihat</b>  | $\frac{\text{interest expense}_t}{0.5(\text{liability}_t + \text{liability}_{t-1})} \times 100$ |
| Asset size           | <b>asize</b> | $\ln(\text{asset})$   |
| Employment size      | <b>esize</b> | $\ln(\text{number of employees})$   |
| Return on equity     | <b>ROE</b>   | net income / equity   |

Before we get into the details of formal measure of firm financial constraints, I first examine the time series behavior of average investment of the firms in the dataset. Figure 2.9 shows the average  $I/K$  ratio and aggregated  $I/K$  ratio of large and small firms along with the stock of reserves(dashed line). The left panel shows the average of individual firms'  $I/K$  ratio, and the right panel shows the ratio of aggregated investment to aggregated capital within each groups of firms. Firms with average employment size larger than 300 are classified as large firms. Small firms' investment recovered soon after the crisis of 1997 while large firms' investment continues to be below the before crisis level in both of the graphs. It can be seen

that the drop in investment shown in Figure 2.1 is mostly driven by large firms rather than SMEs.

Figure 2.9: Investment of Large Firms and Small Firms

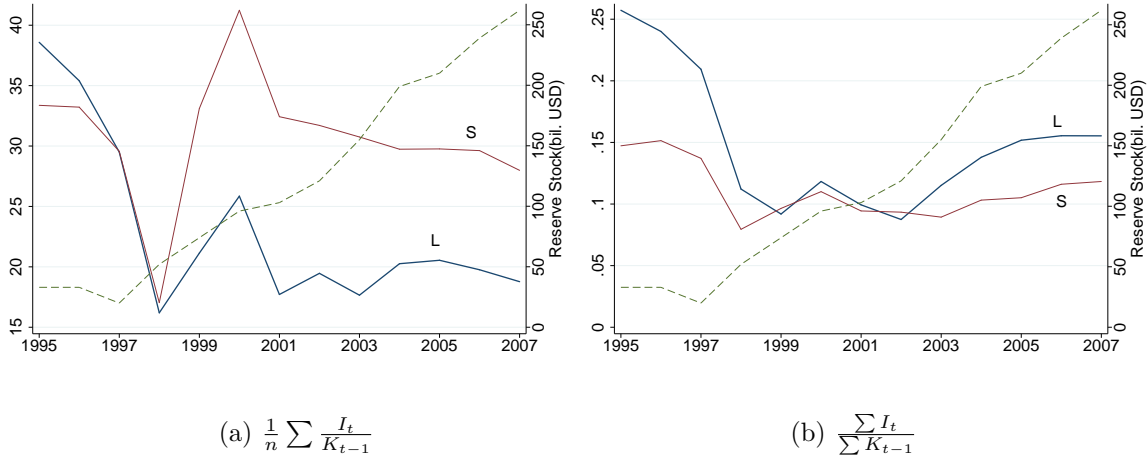

NOTES: The left axis is for the investment-capital ratio with the formular presented under each panel. The right axis is for the reserve stock(dashed lines). Top 1% is windsorized in the panel (a). The red lines are for small firms and blue lines are for large firms. They are indicated by S and L notation.

### 2.3.4 Measuring Firm Financial Constraints

I first perform tests used in previous studies to check whether the investment-cash sensitivity appears to be a reasonable measure of financial constraints in my sample. Table 2.4 reports a couple of applications of the empirical model. Every regression in this paper includes firm and Sector  $\times$  Year dummies. Sector  $\times$  Year dummies will absorb sectoral shocks and business cycle factors.

Columns (1) and (2) compare the cash sensitivity of investment in two different periods. Korea opened its capital account around 1998 by liberalizing foreign investment in stocks, bonds and bank deposits.<sup>10</sup> There are many studies that show

<sup>10</sup>CP market: February 1998, CD market: December 1998, bond market: December 1997, stock

that financial liberalization reduces financial constraints of firms. One can expect that Korean firms' financial constraints were alleviated significantly after 1998. The two columns (1) and (2) compare 1994-1996 and 2000-2007. The test is done on the same set of continuing firms, therefore the regression coefficients are directly comparable to each other. The cash sensitivity of investment is 10.5 in 1994-1996, and 4.0 during 2000-2007. The sensitivity was lowered significantly during the period of financial liberalization.

Table 2.4: Effect of Financial Openness and Firm Size

|  | (1)       | (2)       | (3)       |
|--|-----------|-----------|-----------|
|  | 1994-1996 | 2000-2007 | 2000-2007 |
| $C_{i,t-1}/K_{i,t-1}$                          | 10.49***  | 4.049***  | 9.617***  |
|  | (1.0400)  | (0.3633)  | (0.9654)  |
| $\text{asize}_{it} \times C_{i,t-1}/K_{i,t-1}$ |           |           | -0.530*** |
|  |           |           | (0.0964)  |
| $S_{i,t-1}/K_{i,t-1}$                          | 0.727***  | 0.581***  | 0.487***  |
|  | (0.0898)  | (0.0269)  | (0.0102)  |
| $\text{asize}_{it}$                            |           |           | -31.99*** |
|  |           |           | (0.6231)  |
| Firm fixed effects                             | yes       | yes       | yes       |
| Sector $\times$ Year fixed effects             | yes       | yes       | yes       |
| Number of observations                         | 4,243     | 12,782    | 59,996    |
| Number of firms                                | 1,624     | 1,624     | 14,325    |

NOTES: Dependent variable is  $(I_{i,t}/K_{i,t-1}) \times 100$ . Standard errors in parentheses. \*\*\*, \*\* and \* denote significance at 1%, 5%, 10%, respectively. Top 5% of  $I/K$ ,  $S/K$ ,  $C/K$  are windsorized.

market: May 1998

Column (3) is the same test as in Forbes (2007). It tests whether the cash sensitivity of investment is different among different-sized firms. One can expect large firms to be less financially constrained, since they tend to have more collateral and better access to financial markets. In column (3), asset size is interacted with cash holdings. The coefficient is negative and significant, meaning that as firm size gets larger, the cash sensitivity of investment gets smaller.

These results are in line with previous studies, and they support the validity of using the cash sensitivity of investment as a measure of financial constraints. Hereafter, I interpret this sensitivity as the degree of financial constraints.

### 2.3.5 Main Results

Table 2.5 shows the main empirical results of this chapter. Column (1) is a direct estimation of Eq.(2.38). It does not differentiate by firm size. The cash sensitivity of investment is 4.215 and it is statistically significant. But the effect of reserve accumulation on the cash sensitivity is not statistically significant without firm size differentiation.

Column (2) presents the main result. To see whether the effect of reserve accumulation is different by firm size, I create a dummy variable  $d_L$ , which is equal to one if firms' employment is larger than 300, and zero otherwise. The Korean government provides various supports to small and medium sized enterprises, while large firms are subject to more strict regulation. Employment size 300 is one of

Table 2.5: Effects of Reserve Accumulation on Firm Financial Constraints

|  | (1)                  | (2)                  | (3)                   | (4)                  |
|--|----------------------|----------------------|-----------------------|----------------------|
|  | no size effect       | 300                  | 200                   | 100                  |
| $d_L \times \text{res}_{t-1} \times C_{i,t-1}/K_{i,t-1}$ |                      | 0.587**<br>(0.2691)  | 0.418**<br>(0.2074)   | 0.431***<br>(0.1423) |
| $\text{res}_{t-1} \times C_{i,t-1}/K_{i,t-1}$            | -0.0401<br>(0.0631)  | -0.0802<br>(0.0648)  | -0.0913<br>(0.0661)   | -0.149**<br>(0.0715) |
| $C_{i,t-1}/K_{i,t-1}$                                    | 4.215***<br>(0.2463) | 4.348***<br>(0.2528) | 4.373***<br>(0.2585)  | 4.448***<br>(0.2791) |
| $d_L \times C_{i,t-1}/K_{i,t-1}$                         |                      | -1.881*<br>(0.9782)  | -1.240*<br>(0.7478)   | -0.877*<br>(0.5275)  |
| $d_L \times \text{res}_{t-1}$                            |                      | -1.158**<br>(0.4762) | -1.135***<br>(0.4065) | -0.905**<br>(0.3581) |
| $S_{i,t-1}/K_{i,t-1}$                                    | 0.526***<br>(0.0106) | 0.525***<br>(0.0106) | 0.525***<br>(0.0106)  | 0.525***<br>(0.0106) |
| Firm fixed effects                                       | yes                  | yes                  | yes                   | yes                  |
| Sector $\times$ Year fixed effects                       | yes                  | yes                  | yes                   | yes                  |
| Number of observations                                   | 59,716               | 59,716               | 59,716                | 59,716               |
| Number of firms  | 14,282               | 14,282               | 14,282                | 14,282               |

NOTES: Dependent variable is  $(I_{i,t}/K_{i,t-1}) \times 100$ . Standard errors in parentheses. \*\*\*, \*\* and \* denote significance at 1%, 5%, 10%, respectively. Top 5% of  $I/K$ ,  $S/K$ ,  $C/K$  are winsorized. Employment size 300 corresponds to 94.1 percentile, 200 to 90.4 percentile, and 100 to 79.6 percentile.

the key criteria used to officially define SMEs. There are 1,378 firms with  $d_L = 1$  in the sample. This is 5.9% of the entire sample, but their sales and investment amount to 64.6% and 73.7% of the entire sample, respectively. I interact this dummy variable with  $\text{res}_{t-1} \times C_{i,t-1}/K_{i,t-1}$ . The coefficient is 0.587 and is significant. This means that large firms are more financially constrained when reserve accumulation is high. For firms with less than 300 employees,  $d_L = 0$  and the coefficient on  $\text{res}_{t-1} \times C_{i,t-1}/K_{i,t-1}$  is negative and insignificant. Hence, there is no statistical evidence that small firms' investment sensitivity to cash flow is associated with reserve accumulation. Column (3) and (4) do the same exercise with different size thresholds, and the results remain virtually unaffected.

The magnitude of the coefficients suggests that the effect of reserve accumulation is also economically significant. For large firms, the coefficient on  $C_{i,t-1}/K_{i,t-1}$  is 2.47. This coefficient measures the financial constraint when there is no reserve accumulation ( $\text{res}=0$ ). If reserve accumulation increases by one percent of GDP, the constraint measure rises by 0.587, roughly a 23.8% increase. In contrast, for small firms, the coefficient is 4.35 and is not affected by reserve accumulation. Put differently, if reserve accumulation increases from zero to 3.2% of GDP (which is the average during the sample period), then a large firm with median  $C_{i,t-1}/K_{i,t-1}(=0.15)$  reduces its investment-capital ratio by 3.4 percentage points. For small firms, the effect is not statistically significant.

### 2.3.6 Counterfactual Exercise

Using the result in column (2) of Table 2.5, I calculate the aggregate investment loss due to reserve accumulation. I measure investment loss for each large firm and sum across firms to measure the aggregate effect. The following equation explains the calculation:

$$\Delta I_{i,t} = \frac{1}{100} \left( 0.587d_L \frac{C_{i,t-1}}{K_{i,t-1}} - 1.158d_L \right) K_{i,t-1} \Delta \text{res}_{t-1} \quad (2.39)$$

The coefficient on  $\text{res}_{t-1} \times C_{i,t-1}/K_{i,t-1}$ , 0.0802, is not included in the calculation as there is no statistical evidence that the coefficient is different from zero. The investment losses of large firms due to reserve accumulation are aggregated to be 1.6% of GDP on average per years over 2000 to 2007.<sup>11</sup> Put differently, I calculate that 1% of GDP reserve accumulation reduces aggregate investment by 0.5% of GDP on average.

The dashed line in Figure 2.10 shows the counterfactual gross fixed capital formation relative to GDP in the case of no reserve accumulation, starting from year 2000. The decline in the counterfactual investment is much milder than the actual statistics.

---

<sup>11</sup>2000 2.9%, 2001 2.5%, 2002 0.7%, 2003 0.9%, 2004 1.7%, 2005 2.3%, 2006 1.0%, 2007 0.9%



Figure 2.10: Counterfactual Gross Fixed Capital Formation

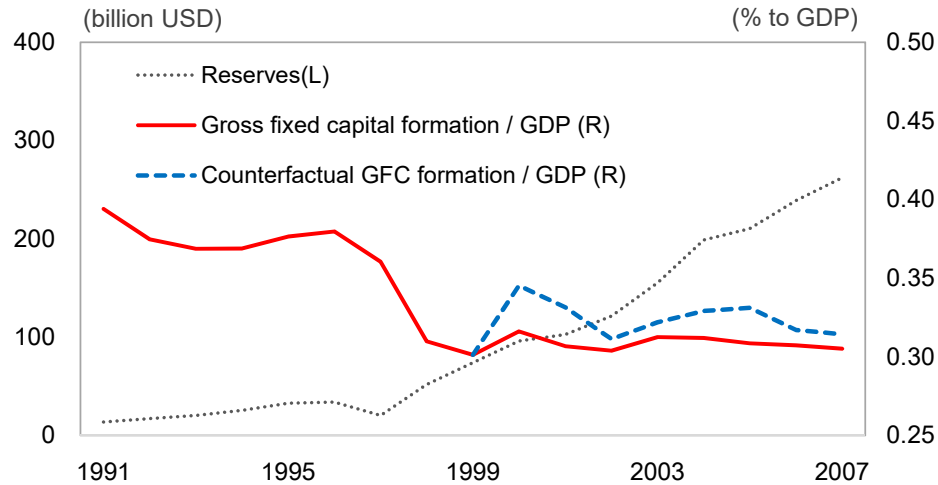

NOTES: The data is from the Bank of Korea. The dotted line shows reserve stock using the left axis. The red line is the actual gross fixed capital formation to GDP ratio. The blue dashed line shows the counterfactual exercise.

### 2.3.7 Dynamic Model

Investment is often serially correlated and it is common in investment regressions to include lags of investment as regressors. In this section, I include a lagged investment-capital ratio as an additional regressor and test robustness of the main finding. In panel data models, the presence of a lagged dependent variable biases coefficient estimates. The Arellano-Bond estimator (Arellano and Bond (1991)) addresses this problem by doing GMM estimation using lagged levels of regressors as instruments. I follow this approach in the following estimation of dynamic panel models.

Table 2.6 presents the results. I use a maximum three lags of the lagged investment-capital ratio as instruments. The coefficients on the lagged investment-

capital ratios are positive and significant in all three regressions. The first column shows the impact of reserve accumulation without controlling for firm size. The coefficient of financial constraints decreases after reserve accumulation. When I allow the measure of financial constraints to vary with firm size in column (2), however, it can be seen that large firms' financial constraints increase while small firms' decrease after reserve accumulation. The result in column (2) is not very different from the main results presented in the previous section.

[Arellano and Bond \(1991\)](#) suggests two tests to check the validity of the GMM estimator they develop. The Sargan test examines the null hypothesis of no correlation between residual and the instruments used. The lower section of [Table 2.6](#) shows the test results. Sargan test statistics of all three regressions support the validity of the instruments. A concern is the serial correlation. Arellano-Bond GMM estimator requires that the error be serially uncorrelated, and this needs to be explicitly tested. In columns (1) and (2), there are weak evidence of second order serial correlation in the error term. One way to resolve this problem is to add additional lags of the dependent variables, which I do in column (3). Adding a second order lag does remove the serial correlation, but we lose one third of the observations. As a consequence, the main regressors in the regression lose statistical significance although the signs of coefficients stay the same. The magnitude of the coefficients does not change much either.

Table 2.6: Dynamic Model Estimation

|  | (1)                  | (2)                   | (3)                   |
|--|----------------------|-----------------------|-----------------------|
|  | $I_{i,t}/K_{i,t-1}$  | $I_{i,t}/K_{i,t-1}$   | $I_{i,t}/K_{i,t-1}$   |
| $I_{i,t-1}/K_{i,t-2}$                                    | 0.109***<br>(0.0096) | 0.109***<br>(0.0096)  | 0.127***<br>(0.0146)  |
| $I_{i,t-2}/K_{i,t-3}$                                    |                      |                       | 0.0285***<br>(0.0104) |
| $d_L \times \text{res}_{t-1} \times C_{i,t-1}/K_{i,t-1}$ |                      | 0.874**<br>(0.4218)   | 1.061<br>(0.6819)     |
| $\text{res}_{t-1} \times C_{i,t-1}/K_{i,t-1}$            | -0.358**<br>(0.1549) | -0.426***<br>(0.1644) | -0.360<br>(0.2357)    |
| $d_L \times C_{i,t-1}/K_{i,t-1}$                         |                      | -3.064*<br>(1.8260)   | -4.802**<br>(2.3049)  |
| $d_L \times \text{res}_{t-1}$                            |                      | -0.634*<br>(0.3544)   | -0.219<br>(0.4525)    |
| $C_{i,t-1}/K_{i,t-1}$                                    | 6.189***<br>(0.6519) | 6.440***<br>(0.6894)  | 7.200***<br>(0.9480)  |
| $S_{i,t-1}/K_{i,t-1}$                                    | 0.927***<br>(0.0450) | 0.927***<br>(0.0450)  | 0.936***<br>(0.0656)  |
| Firm fixed effects                                       | yes                  | yes                   | yes                   |
| Year fixed effects                                       | yes                  | yes                   | yes                   |
| Number of observations                                   | 27,852               | 27,852                | 19,726                |
| Number of firms  | 7,981                | 7,981                 | 6,084                 |
| Sargan test  | 16.8                 | 17.1                  | 13.5                  |
| Serial correlation                                       | 1.85*                | 1.89*                 | 0.95                  |

NOTES: Dependent variable is  $(I_{i,t}/K_{i,t-1}) \times 100$ . Standard errors in parentheses. \*\*\*, \*\* and \* denote significance at 1%, 5%, 10%, respectively. Top 5% of  $I/K$ ,  $S/K$ ,  $C/K$  are winsorized.

<sup>1</sup> Sargan test is the  $\chi^2$  statistic from the test of the null hypothesis that the overidentifying restrictions are valid.

<sup>2</sup> Serial correlation test is the  $Z$  statistic from the null hypothesis that no second order serial correlation in the residuals.

### 2.3.8 Effect on Firm Interest Rate

In this subsection, I test whether firms pay disproportionately higher interest rates after reserve accumulation. Motivated by the model prediction that the required average rate of return on capital rises more in large firms than in small firms following an increase in reserve accumulation, I posit that reserve accumulation makes the interest burden relatively heavier for larger firms. It is a daunting task to identify crowding out effect from changes in the interest rate. The traditional crowding out literature finds little to no evidence for an effect of government borrowing on private interest rates.<sup>12</sup> Recognizing this limitation, I check the correlation between central bank borrowing and firm level interest rates in my dataset.

I build a proxy of average interest rates, `ihat`, for each firm and each year using their liabilities and interest expense over the year. The exact definition is shown in Table 2.3. As in the previous subsection, I lag reserve accumulation by one year. The estimating equation is:

$$\text{ihat}_{i,t} = \delta_i + \delta_t + \beta \text{res}_{t-1} \cdot \text{size}_i + \epsilon_{i,t} \quad (2.40)$$

Table 2.7 shows the results. Column (1) uses employment size, and column (2) uses asset size. As expected, the coefficient on the interaction term is positive and significant in both regressions. I interpret the magnitude using the asset size regression as follows. For a 90th percentile sized firm (`asize=10.8`), a 3.2 percentage

---

<sup>12</sup>In *the new Palgrave dictionary of economics* (Durlauf et al. (2008)), Blanchard puts it that “... the effect of government debt on interest rate; empirical evidence, from both across countries and from the last two centuries, shows surprisingly little relation between the two.”

point rise in `res` is associated with an increase in the proxy interest rate of 0.34 percentage points. For smaller firms this effect is smaller. If the firm size is at the 10th percentile(`asize=7.3`), then the effect is 0.23 percentage points. Although the economic significance of the coefficients is rather small, this result supports the previous financial constraint regressions in the sense that larger firms are more negatively affected by reserve accumulation.

Table 2.7: Interest Rate Regression

|  | (1)                            | (2)                            |
|--|--------------------------------|--------------------------------|
|  | <code>ihat<sub>it</sub></code> | <code>ihat<sub>it</sub></code> |
| <code>esize<sub>i</sub> × res<sub>t-1</sub></code> | 0.014***<br>(0.0027)           |                                |
| <code>asize<sub>i</sub> × res<sub>t-1</sub></code> |                                | 0.010***<br>(0.0022)           |
| <code>ROE<sub>i,t-1</sub></code>                   | -0.017***<br>(0.0030)          | -0.017***<br>(0.0030)          |
| Firm fixed effects                                 | yes                            | yes                            |
| Sector × Year fixed effects                        | yes                            | yes                            |
| Number of observations                             | 112,803                        | 115,624                        |
| Number of firms                                    | 19,037                         | 20,123                         |

NOTES: Standard errors in parentheses. \*\*\* denotes significance at 1%. `ihat` is windsorized at 1% level.

## 2.4 Conclusion

This article investigates whether there is investment loss caused by reserve accumulation. Two different methodologies are used to evaluate the effects of reserve accumulation on different sized firms' investment. First, I build a model that shows that a central bank hinders capital flows to productive sectors by accumulating international reserves. The effect is larger on large and safe firms which issue debt securities more substitutable with risk-free sterilization bonds. Second, I investigate a panel of Korean firms to find that large firms' cash sensitivity of investment significantly rises after reserve accumulation, whereas small firms' sensitivity is not associated with reserve operations. I also find that large firms' interest rate tends to rise more than small firms' after reserve accumulation. These empirical findings are consistent with the model prediction.

Although large firms are small in number, their significance in the economy is large. In the sample, they are about 6% of the sample in number, but their investment is 73.7% of aggregate investment. The cost of reserves in terms of forgone investment is economically significant. I gauge the annual investment losses due to reserve accumulation to be 1.6% of GDP on average from 2000 to 2007 in Korea. Although reserves may have important benefits, policy makers should also account for these potential costs on investment.

## Appendix A: Appendix for Chapter 1

### A.1 Existence and Uniqueness of Equilibrium

The model in Chapter 1 yields a closed form solution for every endogenous variable. The propositions that characterize the competitive equilibrium are derived by differentiating the endogenous variables by reserve accumulation. To get the analytical solution, I begin with the following minimal set of equations that defines equilibrium:

$$zK_1 - \frac{1}{\lambda_1} - L_2 + Q - e_1F = 0 \quad (\text{A.1})$$

$$zK_1 + zL_2 - \frac{1}{\lambda_2} - zQ + R^*e_2F = 0 \quad (\text{A.2})$$

$$Q = \frac{z}{\Gamma}e_1 - \frac{R^*}{\Gamma}e_2 \quad (\text{A.3})$$

$$\frac{\chi}{\lambda_1} = zK_1 - L_2 - e_1 \quad (\text{A.4})$$

$$\frac{\chi}{\lambda_2} + e_2 = zK_1 + zL_2 \quad (\text{A.5})$$

(A.1) and (A.2) are the resource constraints(FX market clearing conditions) and (A.4) and (A.5) are home goods market clearing conditions combined with house-

holds' optimal behavior. Plugging (A.3)-(A.5) into (A.1) and (A.2), I get the following two linear equations with two unknowns  $e_1$  and  $L_2$ .

$$\underbrace{\left(\frac{1}{\chi} + \frac{z - R^*}{\Gamma} - F\right)}_A e_1 + \underbrace{\left(\frac{1 - \chi}{\chi} - \frac{(1 + z)R^*}{\Gamma}\right)}_B L_2 = \frac{1 - \chi}{\chi} z K_1 \quad (\text{A.6})$$

$$\underbrace{\left(\frac{1}{\chi} + \frac{z(R^* - z)}{\Gamma} + R^*F\right)}_C e_1 + \underbrace{\left(\frac{1}{\chi} + z + (1 + z)R^*\left(\frac{z}{\Gamma} + F\right)\right)}_D L_2 = \frac{1 - \chi}{\chi} z K_1 \quad (\text{A.7})$$

A, B, C and D are the references to the corresponding terms. A unique solution to this system of equations exists if the coefficients matrix is non-singular.

### Existence of a Unique Equilibrium

*Within the assumed ranges of parameters, there exists a unique equilibrium.*

If the determinant of the coefficient matrix,  $AD - BC$  is not zero, then there exists a unique equilibrium. The determinant is derived as a quadratic function of  $F$ :

$$AD - BC = -R^*(1 + z)F^2 + \left(\frac{R^*}{\chi}(\chi + z) - \frac{1}{\chi} - z\right)F + \frac{1 + z}{\chi\Gamma}(z(1 + R^*) + \Gamma) \quad (\text{A.8})$$

The two values of  $F$  that make the determinant zero are either negative or greater than one. We are assuming that FX reserve  $F$  cannot be negative, and also it cannot exceed total exports which is equal to one measured in foreign currency. Therefore, there exists a unique equilibrium.



## A.2 Proofs of Propositions

**Proposition 1.** (Ricardian equivalence failure) *Private capital inflows cannot fully offset public capital outflows.*

$$0 < \frac{\partial(Q/e_1)}{\partial F} < 1$$

*Proof.*  $Q/e_1$  and its derivative with respect to  $F$  are calculated as:

$$\begin{aligned} \frac{Q}{e_1} &= \frac{z - R^*}{\Gamma} - \frac{R^*(1+z)}{\Gamma} \frac{(A-C)}{(D-B)} \\ \frac{\partial(Q/e_1)}{\partial F} &= \frac{R^*[(\Gamma - 2)(1 + R^*) + (1 + z)^2]}{(\Gamma + (1 + z)R^* + R^*\Gamma F)^2} \end{aligned} \quad (\text{A.9})$$

In the above,  $z$  is assumed to be greater than  $R^*$ , hence the numerator of (A.9) is positive. The denominator is squared term, so (A.9) is positive. It can also be shown that the denominator is larger than the numerator, hence (A.9) is less than one within the range of parameters and exogenous variables.  $\square$

**Proposition 2.** *Banks cut loans to firms when the central bank accumulates more reserves.*

$$\frac{\partial L_2}{\partial F} < 0$$

*Proof.*  $L_2$  and its derivative with respect to  $F$  are derived as:

$$\begin{aligned}
L_2 &= \frac{A-C}{AD-BC} \frac{1-\chi}{\chi} z K_1 \\
\frac{\partial L_2}{\partial F} &= \frac{\frac{1-\chi}{\chi} z K_1 (1+z)}{(AD-BC)^2} \left[ -R^*(1+R^*)F^2 + \frac{2}{\Gamma} R^*(1+z)(z-R^*)F \right. \\
&\quad \left. - \frac{1+R^*}{\chi} - \frac{R^*(1+z)^2}{\chi\Gamma} + \frac{(z-R^*)^2}{\Gamma} \right] \\
&< 0
\end{aligned} \tag{A.10}$$

In the equation (A.10), the terms in the square brackets is a quadratic function of  $F$ . It is straightforward to show that the sum of those terms is negative within the assumed range of  $F$ .  $\square$

**Corollary 1.** (Crowding-out coefficient) *The model crowding-out coefficient is calculated as below.*

$\partial L_2 / \partial F$  is derived in the Proposition 2. Dividing it by  $e_1$ ,

$$\begin{aligned}
-\frac{\partial L_2}{\partial F} \frac{1}{e_1} &= \frac{1+z}{(AD-BC)(D-B)} \left[ R^*(1+R^*)F^2 - \frac{2}{\Gamma} R^*(1+z)(z-R^*)F \right. \\
&\quad \left. + \frac{1+R^*}{\chi} + \frac{R^*(1+z)^2}{\chi\Gamma} - \frac{(z-R^*)^2}{\Gamma} \right] \\
&= \frac{R^*(1+R^*)F^2 - \frac{2R^*}{\Gamma}(1+z)(z-R^*)F + \frac{1+R^*}{\chi} + \frac{R^*(1+z)^2}{\chi\Gamma} - \frac{(z-R^*)^2}{\Gamma}}{\left(1 + \left(\frac{z-1}{\Gamma} + F\right)R^*\right) \left(\frac{(1+z)(\Gamma+z(1+R^*))}{\chi\Gamma} + \left(\frac{R^*}{\chi}(\chi+z) - \frac{1}{\chi} - z\right)F - R^*(1+z)F^2\right)}
\end{aligned}$$

**Proposition 3.** *The exchange rate depreciates as reserves are accumulated.*

$$\frac{\partial e_1}{\partial F} > 0$$

*Proof.* From (A.6) and (A.7), the closed form solution for the first period exchange rate is derived as:

$$e_1 = \frac{D - B}{AD - BC} \frac{1 - \chi}{\chi} z K_1$$

Differentiating the above with respect to  $F$ ,

$$\begin{aligned} \frac{\partial e_1}{\partial F} &= \frac{\frac{1-\chi}{\chi} z K_1 (1+z)}{(AD - BC)^2} \left[ R^* (AD - BC) \right. \\ &\quad \left. - \left( \frac{R^*}{\chi} (\chi + z) - \frac{1}{\chi} - z - 2R^* (1+z) F \right) \left( 1 + \frac{R^* (z-1)}{\Gamma} + R^* F \right) \right] \\ &= \frac{\frac{1-\chi}{\chi} z K_1 (1+z)}{(AD - BC)^2} \left[ (1+z) R^{*2} F^2 + 2R^* (1+z) \frac{(z-1)R^* + \Gamma}{\Gamma} F + \frac{R^* (1+z)}{\chi} \right. \\ &\quad \left. + \frac{(z-1)R^* + \Gamma}{\Gamma} (z - R^*) + \frac{1}{\chi \Gamma} (z^2 R^{*2} + 2(zR^* + zR^{*2}) - R^* - \Gamma(R^* z - 1)) \right] \\ &> 0 \end{aligned}$$

The term in front of the square brackets is positive. Inside the square brackets, only the last two terms are negative, but the absolute size of them are smaller than the sum of the other positive terms. Therefore, the partial is positive.  $\square$

**Proposition 4.** (Consumption crowding-out) *Consumption of both home goods and foreign goods is crowded out by reserve accumulation.*

$$\frac{\partial C_{H,1}}{\partial F} < 0, \text{ and } \frac{\partial C_{F,1}}{\partial F} < 0$$

*Proof.* Starting from the first period budget constraint of the household,

$$\begin{aligned} e_1 C_{F,1} &= \pi_{B,1} - C_{H,1} \\ &= Q - S + e_1 \\ C_{F,1} &= \frac{Q}{e_1} - F + 1 \end{aligned}$$

Therefore,  $\frac{\partial C_{F,1}}{\partial F} = \frac{\partial Q/e_1}{\partial F} - 1$ . From the Proposition 1,  $\frac{\partial Q/e_1}{\partial F}$  is between zero and one. Thus,  $\frac{\partial C_{F,1}}{\partial F}$  is negative.

Next, from equation (1.3), if  $\frac{\partial e_1 C_{F,1}}{\partial F} < 0$ , then  $\frac{\partial C_{H,1}}{\partial F} < 0$ . By Proposition 3,  $\frac{\partial e_1}{\partial F}$  is positive and it was proven above that  $\frac{\partial C_{F,1}}{\partial F} < 0$ . Therefore,  $\frac{\partial e_1 C_{F,1}}{\partial F} < 0$  and  $\frac{\partial C_{H,1}}{\partial F} < 0$ .  $\square$

**Proposition 5.** *The period one trade balance increases in reserve accumulation.*

$$\frac{\partial TB_1}{\partial F} > 0$$

*Proof.* Trade balance of the first period measured in domestic currency is same as

$e_1 - e_1 C_{F,1}$ . The first term  $e_1$  is exports and it is increasing in reserve accumulation (Proposition 3). The second term  $e_1 C_{F,1}$  is import, and it was shown in the proof of Proposition 4 that  $\frac{\partial e_1 C_{F,1}}{\partial F} < 0$ . Therefore, exports increases and imports decreases. Together, trade balance improves.  $\square$

The five propositions characterize the effect of reserve accumulation on the competitive equilibrium outcome. They can be summarized in the following national account identities. The arrows show qualitative changes after reserve accumulation.

$$Y = \underbrace{C}_{\downarrow} + \underbrace{I}_{\downarrow} + \underbrace{X}_{\uparrow} - \underbrace{M}_{\downarrow}$$

$$\underbrace{TB}_{\uparrow} = CA = FA = \underbrace{e_1 F - Q}_{\uparrow}$$

### A.3 Numerical Illustration of the Model

I include here numerical examples to show how the driving forces work. Table [A.1](#) shows the chosen parameters.  $\chi$  is 0.5, so the households weigh home goods and foreign goods equal. Productivity  $z$  is chosen to be 10% greater than the world interest rate  $R^*$  which is same as one. 0.1 for  $\Gamma$  is following [Gabaix and Maggiori \(2015\)](#).<sup>1</sup> The initial capital stock is chosen to be two to make the exchange rate around one.

Table A.1: Parameterization

| $\chi$ | $z$ | $R^*$ | $\Gamma$ | $K_1$ |
|--------|-----|-------|----------|-------|
| 0.5    | 1.1 | 1.0   | 0.1      | 2.0   |

I calculate equilibria with 11 different levels of FX reserve accumulation ranging from zero to one. Figure [A.1](#) shows the results. Each panel corresponds to Proposition 1 to 5 and Corollary 1. The upper-left panel illustrates Proposition 1. It shows that private inflows increase with public outflows, but cannot fully offset the outflows. The upper-right panel shows bank loan crowding out. The middle panels describes exchange rate depreciation and consumption crowding out. The bottom-left panel illustrates trade balance improvement. The bottom-right panel shows the crowding out coefficient. The coefficient is within the range of 0.3 to 0.5 and it is broadly compatible with the empirical finding.

---

<sup>1</sup>They note that  $\Gamma = 0.1$  is in broad congruence with the experience of Israel and Switzerland during the recent financial crisis.

Figure A.1: Numerical Illustrations

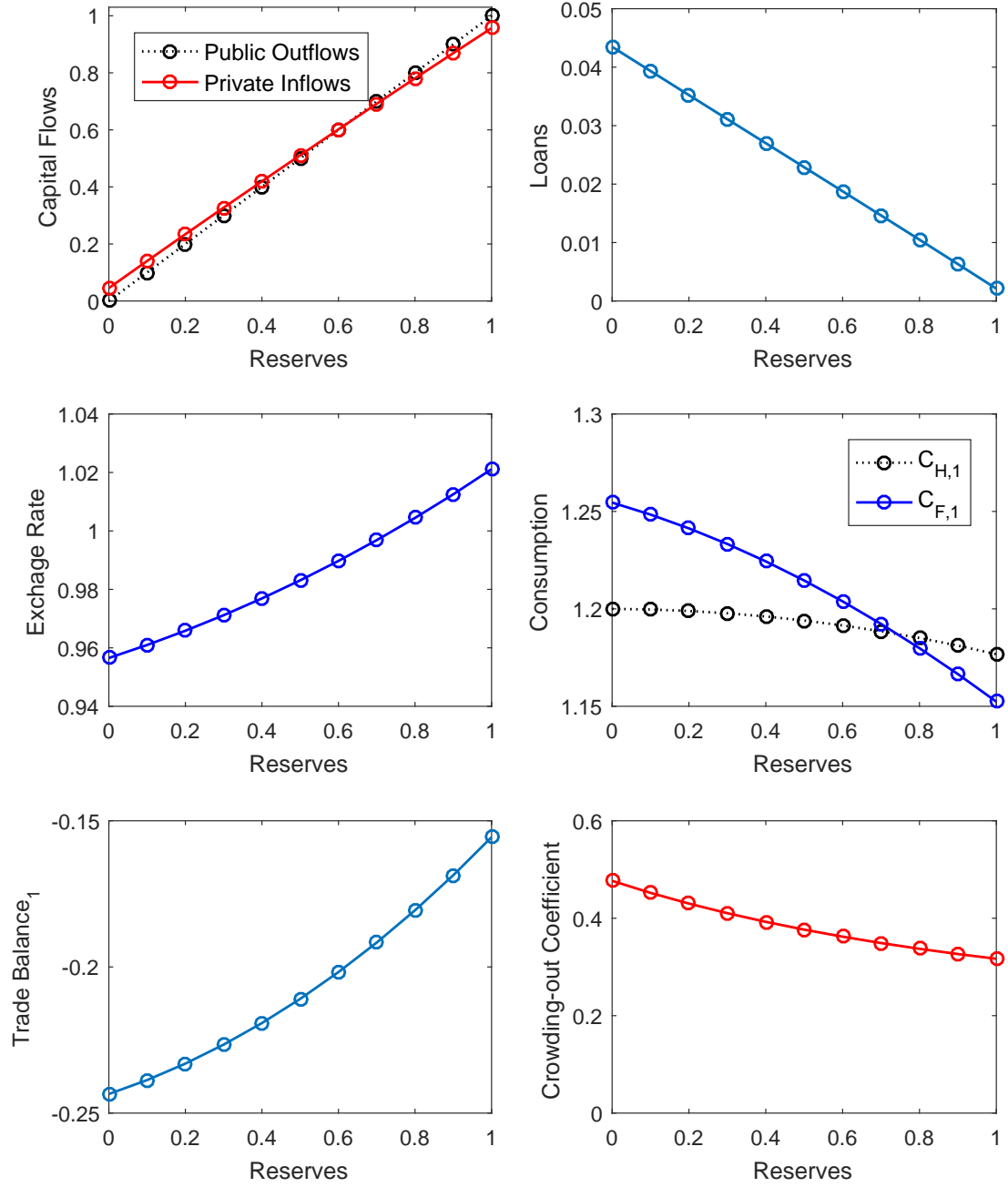

## Appendix B: Appendix for Chapter 2

### B.1 Sample Selection

All firms subject to mandatory external audit under Korean law are included in the sample; firms established after 2005, firms with employment size smaller than two, firms with asset size smaller than 2.7 million KRW, firms whose book closing month is not December are excluded. The sample does not include financial firms and firms in public/defence sector. In addition, I drop the following unrealistic observations. The variable definitions are provided in Table 2.3.

- Observations with  $I_t/K_{t-1} < -100$  (529 obs.)
- Observations with  $S_t/K_t < 0$  (26 obs.)
- Observations with  $C_t/K_t < 0$  (723 obs.)

The resulting sample has 211,324 observations and 23,365 firms. After this selection, key variables for the regressions are winsorized as described in each regression tables. The number of firms by sectors is given in Table B.1.



Table B.1: Industry Classification

| Code | KSIC | Name   | Firms  |
|------|------|--|--------|
|      |      | <u>Non-manufacturing Sectors</u>   | 12,542 |
| 1    | A    | Agriculture, forestry, fishing   | 90     |
| 2    | B    | Mining, quarrying  | 77     |
| 3    | D    | Electricity, gas, steam, water supply                                    | 76     |
| 4    | E    | Sewerage, waste management, materials recovery, remediation activities   | 222    |
| 5    | F    | Construction   | 2,325  |
| 6    | G    | Wholesale, retail trade  | 2,809  |
| 7    | H    | Transportation   | 821    |
| 8    | I    | Accommodation, food service activities                                   | 343    |
| 9    | J    | Information, communications  | 1,341  |
| 10   | L    | Real estate activities, renting, leasing                                 | 2,898  |
| 11   | M    | Professional, scientific, technical activities                           | 656    |
| 12   | N    | Business facilities management, business support services                | 254    |
| 13   | P    | Education  | 80     |
| 14   | Q    | Human health, social work activities                                     | 12     |
| 15   | R    | Arts, sports, recreation related services                                | 394    |
| 16   | S    | Membership organizations, repair, other personal services                | 144    |
|      |      | <u>Manufacturing Sectors</u>   | 10,823 |
| 17   | C10  | Food Products  | 486    |
| 18   | C11  | Beverages  | 66     |
| 19   | C12  | Tobacco Products   | 7      |
| 20   | C13  | Textiles, Except Apparel   | 359    |
| 21   | C14  | wearing apparel, Clothing Accessories, Fur Articles                      | 353    |
| 22   | C15  | Tanning, Dressing of Leather , Manufacture of Luggage, Footwear          | 101    |
| 23   | C16  | Wood Products of Wood, Cork ; Except Furniture                           | 81     |
| 24   | C17  | Pulp, Paper, Paper Products  | 211    |
| 25   | C18  | Printing, Reproduction of Recorded Media                                 | 121    |
| 26   | C19  | Coke, hard-coal, lignite fuel briquettes, Refined Petroleum Products     | 52     |
| 27   | C20  | chemicals, chemical products except pharmaceuticals, medicinal chemicals | 732    |
| 28   | C21  | Pharmaceuticals, Medicinal Chemicals, Botanical Products                 | 246    |
| 29   | C22  | Rubber, Plastic Products   | 637    |
| 30   | C23  | Other Non-metallic Mineral Products                                      | 481    |
| 31   | C24  | Basic Metal Products   | 740    |
| 32   | C25  | Fabricated Metal Products, Except Machinery, Furniture                   | 717    |
| 33   | C26  | Electronic Components, Computer, Radio, TV, Communication Equipments     | 1,444  |
| 34   | C27  | Medical, Precision, Optical Instruments, Watches, Clocks                 | 347    |
| 35   | C28  | electrical equipment   | 612    |
| 36   | C29  | Other Machinery, Equipment   | 1,536  |
| 37   | C30  | Motor Vehicles, Trailers, Semitrailers                                   | 1,026  |
| 38   | C31  | Other Transport Equipment  | 268    |
| 39   | C32  | Furniture  | 87     |
| 40   | C33  | Other manufacturing  | 113    |
|      |      | <u>Total</u>   | 23,365 |

## Bibliography

- Adler, G., Lisack, N., and Mano, R. (2015). Unveiling the effects of foreign exchange intervention; a panel approach. *IMF Working Paper*.
- Adler, G. and Mano, R. (2016). The cost of foreign exchange intervention; concepts and measurement. *IMF Working Paper*.
- Aizenman, J. and Glick, R. (2009). Sterilization, monetary policy, and global financial integration. *Review of International Economics*, 17(4):777–801.
- Aizenman, J. and Lee, J. (2008). Financial versus monetary mercantilism: Long-run view of large international reserves hoarding. *The World Economy*, 31(5):593–611.
- Alfaro, L., Kalemli-Özcan, Ş., and Volosovych, V. (2014). Sovereigns, upstream capital flows, and global imbalances. *Journal of the European Economic Association*, 12(5):1240–1284.
- Alfaro, L. and Kanczuk, F. (2009). Optimal reserve management and sovereign debt. *Journal of International Economics*, 77(1):23–36.

- Alti, A. (2003). How sensitive is investment to cash flow when financing is frictionless? *Journal of Finance*, 58(2):707–722.
- Amador, M., Bianchi, J., Bocola, L., and Perri, F. (2016). Exchange rate policies at the zero lower bound. *Federal Reserve Bank of Minneapolis Working Paper*.
- Arellano, M. and Bond, S. (1991). Some tests of specification for panel data: Monte carlo evidence and an application to employment equations. *The review of economic studies*, 58(2):277–297.
- Bacchetta, P., Benhima, K., and Kalantzis, Y. (2013). Capital controls with international reserve accumulation: Can this be optimal? *American Economic Journal: Macroeconomics*, 5(3):229–62.
- Backus, D. K. and Kehoe, P. J. (1989). On the denomination of government debt: a critique of the portfolio balance approach. *Journal of Monetary Economics*, 23(3):359–376.
- Baskaya, Y. S., Giovanni, J. d., Kalemli-Özcan, Ş., and Ulu, M. F. (2017). International spillovers and local credit cycles. *NBER Working Papers*, (No. w23149).
- Benigno, G. and Fornaro, L. (2012). Reserve accumulation, growth and financial crises. *CEP Discussion Paper*, (No. 1161).
- Bernanke, B. (2005). The global saving glut and the us current account, remarks at the sandridge lecture. *Virginia Association of Economics, Richmond, VA*, 10.
- Buch, C. M. and Goldberg, L. S. (2014). International banking and liquidity risk

- transmission: Lessons from across countries. *Federal Reserve Bank of New York Staff Reports*.
- Caballero, R. and Panageas, S. (2005). A quantitative model of sudden stops and external liquidity management. *NBER Working Papers*, (No. w11293).
- Calvo, G. A. (1991). The perils of sterilization. *Staff Papers-International Monetary Fund*, pages 921–926.
- Calvo, G. A., Izquierdo, A., and Loo-Kung, R. (2012). Optimal holdings of international reserves: self-insurance against sudden stop. *NBER Working Papers*, (No.w18219).
- Chen, H. J. and Chen, S. J. (2012). Investment-cash flow sensitivity cannot be a good measure of financial constraints: Evidence from the time series. *Journal of Financial Economics*, 103(2):393–410.
- Cook, D. E. and Yetman, J. (2012). Expanding central bank balance sheets in emerging asia: a compendium of risks and some evidence. *BIS Paper*, 66d.
- Dooley, M. P., Folkerts-Landau, D., and Garber, P. (2004). The revived bretton woods system. *International Journal of Finance & Economics*, 9(4):307–313.
- Durdu, C. B., Mendoza, E. G., and Terrones, M. E. (2009). Precautionary demand for foreign assets in sudden stop economies: An assessment of the new mercantilism. *Journal of Development Economics*, 89(2):194–209.

- Durlauf, S. N., Blume, L., et al. (2008). *The new Palgrave dictionary of economics*, volume 6. Palgrave Macmillan Basingstoke.
- Erel, I., Jang, Y., and Weisbach, M. S. (2015). Do acquisitions relieve target firms financial constraints? *The Journal of Finance*, 70(1):289–328.
- Fanelli, S. and Straub, L. (2016). A theory of foreign exchange interventions.
- Farre-Mensa, J. and Ljungqvist, A. (2015). Do measures of financial constraints measure financial constraints? *Review of Financial Studies*, page hhv052.
- Fazzari, S. M., Hubbard, R. G., and Petersen, B. . (1988). Financing constraints and corporate investment. *Brookings Papers on Economic Activity*, 1988(1):141–195.
- Forbes, K. J. (2007). One cost of the chilean capital controls: increased financial constraints for smaller traded firms. *Journal of International Economics*, 71(2):294–323.
- Gabaix, X. and Maggiori, M. (2015). International liquidity and exchange rate dynamics. *The Quarterly Journal of Economics*, 130(3):1369–1420.
- Gomes, J. F. (2001). Financing investment. *American Economic Review*, pages 1263–1285.
- Harrison, A. E., Love, I., and McMillan, M. S. (2004). Global capital flows and financing constraints. *Journal of Development Economics*, 75(1):269–301.
- Ivashina, V. and Scharfstein, D. (2010). Bank lending during the financial crisis of 2008. *Journal of Financial economics*, 97(3):319–338.

- Jeanne, O. (2012). Capital account policies and the real exchange rate. In *NBER International Seminar on Macroeconomics 2012*, pages 7–42. University of Chicago Press.
- Jeanne, O. and Ranciere, R. (2011). The optimal level of international reserves for emerging market countries: A new formula and some applications. *The Economic Journal*, 121(555):905–930.
- Jiménez, G., Ongena, S., Peydro, J., and Saurina, J. (2017). Macroprudential policy, countercyclical bank capital buffers and credit supply: Evidence from the spanish dynamic provisioning experiments. *Journal of Political Economy*, forthcoming.
- Jiménez, G., Ongena, S., Peydró, J.-L., and Saurina, J. (2014). Hazardous times for monetary policy: What do twenty-three million bank loans say about the effects of monetary policy on credit risk-taking? *Econometrica*, 82(2):463–505.
- Kaplan, S. N. and Zingales, L. (1997). Do investment-cash flow sensitivities provide useful measures of financing constraints? *The Quarterly Journal of Economics*, pages 169–215.
- Korinek, A. and Servén, L. (2010). Real exchange rate undervaluation: static losses, dynamic gains. *World Bank Policy Research Working Paper*, (5250).
- Kumhof, M. (2010). On the theory of sterilized foreign exchange intervention. *Journal of Economic Dynamics and Control*, 34(8):1403–1420.
- Kumhof, M. M. and Tanner, M. E. (2005). Government debt: A key role in financial intermediation. *IMF Working Paper*, (5-57).

- Laeven, L. (2003). Does financial liberalization reduce financing constraints? *Financial Management*, pages 5–34.
- Lavigne, R. (2008). Sterilized intervention in emerging-market economies: trends, costs, and risks. *Bank of Canada Discussion Paper*.
- Love, I. (2003). Financial development and financing constraints: International evidence from the structural investment model. *Review of Financial Studies*, 16(3):765–791.
- Mehrotra, A. (2012). On the use of sterilisation bonds in emerging Asia. *BIS Papers chapters*, 66:111–131.
- Mohanty, M. S. and Turner, P. (2006). Foreign exchange reserve accumulation in emerging markets: what are the domestic implications? *BIS Quarterly Review*, September.
- Obstfeld, M., Shambaugh, J. C., and Taylor, A. M. (2010). Financial stability, the trilemma, and international reserves. *American Economic Journal: Macroeconomics*, 2(2):57–94.
- Reinhart, C. M., Reinhart, V., and Tashiro, T. (2016). Does reserve accumulation crowd out investment? *Journal of International Money and Finance*, 63:89–111.
- Reinhart, C. M. and Reinhart, V. R. (2008). Capital inflows and reserve accumulation: the recent evidence. *NBER Working Papers*, (No. w13842).

- Rodnyansky, A. and Darmouni, O. (2016). The effects of quantitative easing on bank lending behavior. *Review of Financial Studies*, forthcoming.
- Rodrik, D. (2006). The social cost of foreign exchange reserves. *International Economic Journal*, 20(3):253–266.
- Rodrik, D. (2008). The real exchange rate and economic growth. *Brookings papers on economic activity*, 2008(2):365–412.
- The Bank of Korea (2004). *Annual Report*.
- Yu, Y. (2014). China's trilemma. *Project Syndicate Weblog*, (13).