

ABSTRACT

Title of Dissertation: INTEGRATED ECOLOGICAL ECONOMIC
MODELING OF ECOSYSTEM SERVICES FROM THE
BRAZILIAN AMAZON RAINFOREST

Rosimeiry Gomes Portela, Doctor of Philosophy, 2004

Dissertation directed by: Professor Robert Costanza
Marine, Estuarine and Environmental Science Program
(MEES)

This dissertation links the natural and social sciences, using modeling techniques to enhance understanding of the functioning of a complex ecosystem and its relevance to humans. For this purpose, I developed a Regional Unified Metamodel of the Brazilian Amazon (RUMBA) to simulate the Amazon forest provision of ecosystem goods and services and their contribution to human economy and welfare. The model was also used to simulate the potential effect of an incentive to reduce deforestation in return for a payment for avoided releases of carbon into the atmosphere.

Simulation was done from 1975 to 2100, with calibration performed for the first 25 years, and for four scenarios: a baseline scenario, based on historical trends, and four alternative scenarios based on different assumptions and policy choices. The baseline scenario shows deforestation proceeding at high rates, leading to decreasing provision of forest goods and services and increasing economic growth. The growth of GRP per

capita, on the other hand, remains much smaller than that of GRP. Regional welfare decreases significantly over the simulated period. The overall monetary contribution of ecosystem goods and services to the regional economy is estimated as 5 times the GRP in year 2100.

Scenarios of increased investment in development yielded higher economic growth accompanied by lower levels of welfare, while opposite trends were found for scenarios of higher investment in human, knowledge and natural capital. Finally, results also show that in order for a monetary compensation to represent a significant incentive to land owners to reduce deforestation, higher prices for avoided carbon emissions would have to be set than current prices of the emerging carbon market.

Main research findings are that increasing land use change in the Brazilian Amazon incurs significant losses of ecosystem services without this being adequately offset by increasing monetary income or welfare of people. This research has also found that in the absence of significant incentives from global beneficiaries for any one ecosystem service, or a combination of incentives addressing several types of ecosystem services, rational land uses at the local level lead to sub-optimal provision of these services from the global perspective.

INTEGRATED ECOLOGICAL ECONOMIC MODELING OF ECOSYSTEM
SERVICES FROM THE BRAZILIAN AMAZON RAINFOREST

By

Rosimeiry Gomes Portela

Dissertation submitted to the Faculty of the Graduate School of the
University of the Maryland, College Park, in partial fulfillment
of the requirements of the degree of
Doctor of Philosophy
2004

Advisory Committee:

Professor Robert Costanza, Chairman/Advisor
Professor Herman Daly
Assistant Professor David Tilley
Assistant Professor Joshua Farley
Associate Professor Roelof Boumans

©Copyright by

Rosimeiry Gomes Portela

2004

To Jari

for all his encouragement, support and love.

Acknowledgments

I wish to thank the members of my committee: Dr. Robert Costanza, Roelof Boumans, Herman Daly, Joshua Farley and David Tilley, for their support and advice. I am particularly indebted to Dr. Roelof Boumans, and grateful for his patience, guidance and generosity with his time.

I thank Dr. Kennedy Paynter, for his leadership of the MEES program at the University of Maryland. I thank Debbie Morrin-Nordlund and Elizabeth Zinecker for prompt support to MEES students on program-related issues. Thanks also go to Terry Island and Susan Dougherty for support with visa-related paperwork throughout the program.

I thank the former University of Maryland Institute for Ecological Economics for the financial support for my doctorate studies, through grants from the MacArthur Foundation, Ford Foundation and the LOICZ program. I am grateful to Janis King, for her outstanding support with financial-related issues. I also thank the State Foundation for the Environment – FEMA for partially funding my doctorate studies. I am particularly grateful for Frederico Guilherme de Moura Müller, for his leadership of environmental issues at the state of Mato Grosso and great support throughout my studies.

I thank the researchers and the staff of the Gund Institute for Ecological Economics of the University of Vermont for the discussions, technical and logistical support during my many visits to the institute. I thank Roel and Tiny Boumans, Joshua, Andrea and Liam Farley, Shuang Liu and Gary Flomenhoft for hosting me in Burlington Vermont, and for making my visits a time when I could enjoy their friendship.

A special thanks for the Ecological Economics Group of the University of Maryland, for their moral support, insightful discussions and enthusiasm about environmental issues, and about Ecological Economics, in particular. I thank Trista Patterson, Tim Gulden, Egor Kraev, Ken Cousins, Amanda Vemuri, Alexandre Vialou for their leadership in establishing the bi-weekly Ecological Economics Student Group seminar at the University of Maryland.

I thank my friends Charlotte and Michael Streck, Charles Cormier, Richard Warwick, Lekha Subaiya and Ida Rademacher for their continued support and encouragement. I thank my parents, Joao Bosco e Maria Portela, for their love and for being such a wonderful source of advice and support. Thanks to my brothers, sisters, nieces and nephew for their love and acceptance of my absence in our family reunions, and for being so warm and kind in my visits. Thanks also go to Jari's family for their love, kindness and respect. Finally, I thank Jari for his love, care and for reminding me I could make it.

TABLE OF CONTENTS

List of Tables	ix
List of Figures	xi
Chapter 1. Introduction.....	1
1.1. The Brazilian Amazon Forest: Deforestation and Ecosystem Services	1
1.2. Research Hypothesis.....	3
1.3. Research Approach.....	4
1.4. Dissertation Outline	5
Chapter 2. The Brazilian Amazon Overview: Definition, Current Land Uses, Long Term Impact and Potential of a Market-based Alternative.....	7
2.1. Definition	7
2.2. Development and Deforestation.....	8
2.3. Shifting Agriculture, Pasture and Logging	11
2.4. Land Use and Fire Regime.....	13
2.5. Regional and Global Long Term Impact of Deforestation	16
2.6. Private Benefits of Forest Exploitation versus Social Benefits of Forest Protection.....	18
2.7. The Potential of a Carbon Market for the Climate Regulation Service of Forests	20
Chapter 3. Ecological Economics and Dynamic Modeling.....	27
3.1. Sustainable Management of Natural Resources.....	27
3.2. Models Definition, Purposes and Uses	30
3.3. Dynamic Systems Models and Econometric/Statistical Models.....	33
3.4. Models and Public Policy	35
3.5. Models of the Amazon.....	37
3.5.1. Models of Deforestation and its Drivers.....	38
3.5.2. Models of Deforestation and Cost-Benefit Analysis.....	41
3.5.3. Models of Deforestation and its Ecosystem Services.....	43
3.5.4. Models of Deforestation and Climate Change	44
Chapter 4. RUMBA Model Development.....	50
4.1. From Global to Regional: The GUMBO and RUMBA Models	50
4.2. Land Cover/Land Use Sector of RUMBA.....	54
4.2.1. Land Cover.....	55
4.2.2. Land Use	56
4.3. Biosphere Sector of RUMBA	66
4.3.1. Biomass.....	67
4.3.2. Production Limits within Biosphere Sector	72

4.3.2.1. Temperature	72
4.3.2.2. Carbon	73
4.3.2.3. Energy.....	74
4.3.2.4. Nutrients	75
4.3.2.4. Water	76
4.3.3. Primary Production.....	77
4.3.4. Consumption	80
4.3.5. Decomposition	82
4.4. Lithosphere Sector of RUMBA.....	83
4.4.1. Soils Quality and Ecosystem Production.....	84
4.4.2. Carbon in Soils	87
4.4.3. Nitrogen in Soils.....	88
4.4.4. Soil Erosion.....	93
4.4.4.1. Chemical and Mechanical Erosion.....	94
4.5. Hydrosphere Sector of RUMBA	96
4.5.1. Water.....	98
4.5.2. Carbon.....	106
4.5.3. Nitrogen	108
4.6. Atmosphere Sector of RUMBA	113
4.6.1. Energy.....	113
4.6.2. Carbon.....	117
4.6.3. Nitrogen	119
4.6.1. Water.....	120
4.7. Anthroposphere Sector of RUMBA.....	122
4.7.1. Human capital	123
4.7.2. Social capital	126
4.7.3. Built capital	128
4.7.4. Natural capital	129
4.7.4.1. Soil Formation.....	130
4.7.4.2. Gas Regulation.....	131
4.7.4.3. Climate Regulation.....	131
4.7.4.4. Nutrient Cycling.....	132
4.7.4.5. Recreation and Cultural	132
4.7.4.6. Waste Assimilation.....	133
4.7.4.7. Disturbance Regulation	133
4.8. Economic Production and Human Welfare	133
4.8.1. Economic Production	135
4.8.2. Welfare Production	137
4.8.2. Ecosystem Services Value: Marginal Product.....	138
4.9. RUMBA Scenarios	138
4.9.1. Scenario 1: Exploitation with Own Resources.....	141
4.9.2. Scenario 2: Exploitation with Own and External Resources	141
4.9.3. Scenarios 3: Conservation with Own Resources	142
4.9.4. Scenario 4: Conservation with Own and External Resources.....	137
Chapter 5. RUMBA Calibration	145

5.1. Calibration of the Land Cover/Land Use Sector	148
5.2. Calibration of the Biosphere Sector.....	156
5.3. Calibration of the Lithosphere Sector.....	157
5.4. Calibration of the Hydrosphere Sector	161
5.5. Calibration of the Atmosphere Sector	165
5.5.1. Carbon Balance	165
5.5.2. Water Balance	172
5.5.3. Nitrogen Balance	173
5.5.4. Temperature	174
5.6. Calibration with Simulation Models of Amazon Deforestation and Climate Change.....	178
5.7. Calibration of the Anthroposphere Sector	182
Chapter 6. Results	187
6.1. Land Land Cover/Land Use Variables	187
6.2. Climate Variables	189
6.3. Ecosystem Services Variables.....	190
6.4. Capital Variables	191
6.5. Economic Variables.....	193
6.6. Welfare Variables.....	195
6.7. Compensation for Avoided Deforestation	195
Chapter 7. Discussions	226
7.1. Deforestation and Economic Growth of the Brazilian Amazon	226
7.2. Assessment of the Research Hypothesis.....	229
7.3. Alternatives for the Brazilian Amazon Continuous Provision of Ecosystem Services	235
7.3. Model Limitations and Caveats.....	238
Chapter 8. Conclusions.....	241
Appendix A: A dynamic model of patterns of deforestation and their effect on the ability of the Brazilian Amazonia to provide ecosystem services	244
Appendix B: Modeling the Dynamics of the Integrated Earth System and the Value of Global Ecosystem Services Using the Gumbo Model	291
Appendix C: RUMBA Equations.....	348
References	409

LIST OF TABLES

2.1.	Deforestation in the Brazilian Legal Amazon	10
2.2.	Carbon Emissions from Fossil Fuel and Tropical Deforestation	23
2.3.	Potential Carbon Mitigation and Associated Incomes through a Carbon-based Market Mechanism to Mitigate Climate Change	24
3.1.	Models of the Amazon Forest	46
4.1.	Biomass Values of the Land cover/Land Uses in the Brazilian Amazon	71
4.2.	Total Chlorophyll Content of Vegetation Used in the Biosphere Sector	80
4.3.	Carbon Vegetation, Litter and Soil Content of Forest and Forest-Derived Uses Used in the Biosphere Sector	88
4.4.	Nitrogen Content, Inputs and Outputs Used in the Biosphere Sector	92
4.5.	Values of Parameters/Property or Field Used in the Hydrosphere Sector	102
4.6.	Overview of the Scenarios Simulated in RUMBA	143
4.7.	Parameters Used to Determine Policies and Assumptions for the Investments in Formation of Capitals, Consumption and Trade Debt for Baseline and Four Alternative Scenarios of RUMBA	144
5.1.	Parameters/Datasets Used in the Calibration of the Land Cover/Land Use Sector	152
5.2.	Values Used in Calibration of the Land Cover/Land Use Sector	155
5.3.	Total Annual Net Primary Productivity (NPP) Used in Calibration of the Biosphere Sector	155
5.4.	Soil Carbon and Nitrogen Content Values Used in Calibration of the Lithosphere Sector	158
5.5.	Erosion Balance of the Amazon and its Main Tributaries Used in the Calibration of the Lithosphere Sector	160
5.6a.	Carbon (TOC and DIC) Values Used in Calibration of the Biosphere/Hydrosphere Sectors	163

5.6b.	Carbon (DIC) Values Used in Calibration of the Hydrosphere Sector	164
5.7.	Nitrogen Discharge in the Amazon River ($T \text{ km}^{-2} \text{ yr}^{-1}$)	166
5.8.	Nitrogen Values Used in the Calibration of the Hydrosphere Sector ($T \text{ yr}^{-1}$)	166
5.9.	Carbon Balance Values Used in the Calibration of the Atmosphere Sector	168
5.10.	Water Mass Balance Values Used in the Calibration of the Atmosphere Sector ($E12 \text{ m}^3 \text{ yr}^{-1}$)	173
5.11.	Nitrogen Values Used in the Calibration of the Atmosphere Sector ($E8 \text{ Ton N yr}^{-1}$)	174
5.12.	Temperature Values Used in the Calibration of the Atmosphere Sector ($E8 \text{ Ton N yr}^{-1}$)	175
5.13.	Simulation Models of Amazon Deforestation and Climate Change	180
5.14.	Population of the Legal Amazon, Brazil	182
5.15.	Waste Produced in the Legal Amazon, Brazil	183
5.16.	Gross Regional Product (GRP) of the Legal Amazon, Brazil	185
5.17.	International and Interregional Trade Balance of the North Region	186
6.1.	Average Values of Ecosystem Services Provision for Forest, Agriculture and Pasture	192

LIST OF FIGURES

2.1.	Legal Amazon, Brazil, Vegetation Cover (1992)	8
4.1.	RUMBA Model Basic Structure	53
4.2.a	STELLA Diagram of the Land Cover/Land Use Sector of RUMBA/Forest Area	60
4.2.b	STELLA Diagram of the Land Cover/Land Use Sector of RUMBA/Savanna Area	61
4.3.	STELLA Diagram of the Biosphere Sector of RUMBA	68
4.4.	STELLA Diagram of the Lithosphere Sector of RUMBA	86
4.5.	STELLA Diagram of the Hydrosphere Sector of RUMBA	97
4.6.	STELLA Diagram of the Atmosphere Sector of RUMBA	115
4.7.a.	STELLA Diagram of the Anthroposphere Sector of RUMBA/Capitals	124
4.7.b.	STELLA Diagram of the Anthroposphere Sector of RUMBA/Economy	125
6.1.	Forest, Annual Deforestation Rates	199
6.2.	Forest, All Land Cover and Uses	200
6.3.	Forest Cover, Remaining Forest	200
6.4.	Forest Cover, Agriculture Use	201
6.5.	Forest Cover, Pasture Use	201
6.6.	Forest Cover, Fallow Use	202
6.7.	Forest Cover, Urban Use	202
6.8.	Precipitation per Unit Area	203
6.9.	Evapotranspiration per Unit Area	203
6.10.	Regional Temperature	204

6.11a.	Forest Carbon Balance	204
6.11a.	Amazon Carbon Balance	205
6.12.	Recreation and Culture Service, Forest	206
6.13.	Gas Regulation Service, Forest	206
6.14.	Climate Regulation Service, Forest	207
6.15.	Disturbance Regulation Service, Forest	207
6.16.	Plant Nutrient Uptake Service, Forest	208
6.17.	Organic Soil Formation, Amounts/Forest	208
6.18.	Waste Assimilation Potential, Amounts/Forest	209
6.19.	Recreation and Culture Service, Price per Unit/Forest	210
6.20.	Gas Regulation Service, Price per Unit/Forest	210
6.21.	Climate Regulation Service, Price per Unit/Forest	211
6.22.	Disturbance Regulation Service, Price per Unit/Forest	211
6.23.	Plant Nutrient Uptake Service, Price per Unit/Forest	212
6.24.	Organic Soil Formation, Amounts/ Price per Unit/Forest	212
6.25.	Waste Assimilation Potential, Price per Unit/Forest	213
6.26.	Recreation and Culture Service, Amounts /Forest and Main Land Uses	214
6.27.	Gas Regulation Service, Amounts /Forest and Main Land Uses	214
6.28.	Climate Regulation Service, Amounts /Forest and Main Land Uses	215
6.29.	Disturbance Regulation Service, Amounts /Forest and Main Land Uses	215
6.30.	Plant Nutrient Uptake Service, Amounts /Forest and Main Land Uses	216
6.31.	Organic Soil Formation, Amounts /Forest and Main Land Uses	216
6.32.	Amazon Population	217

6.33.	Built Capital	217
6.34.	Built Capital per Capita	218
6.35.	Knowledge	218
6.36.	Knowledge per Capita	219
6.37.	Social Network	219
6.38.	Social Network per Capita	220
6.39.	Gross Regional Product	221
6.40.	Gross Regional Product per Capita	221
6.41.	Goods and Services Economic Production	222
6.42.	Goods and Services Economic Production per Capita	222
6.43.	Regional Welfare	223
6.44.	Welfare per Gross Regional Product	223
6.45.	GRP with Monetary Compensation for Avoided Emissions of C as a Result of Implemented Scenario 3 under different Market Prices per tonne of C and for a Single Payment	224
6.46.	GRP with Monetary Compensation for Avoided Emissions of C as a Result of Implemented Scenario 3 under different Market Prices per tonne of C and for a Continuous Payment	225

Chapter 1. Introduction

1.1. The Brazilian Amazon Forest: Deforestation and Ecosystem Services

The Amazon tropical rain forest is the largest tract of tropical forest on Earth (Kohlhepp, 2001). Home of tens of thousands of species of plants (Plotkin, 1988) and of an extremely rich animal and insect fauna (Whitmore, 1996), this forest hosts roughly half of the species of the world (Andersen, 1996). Its present-day vegetation pattern, mostly attributed to the continental drift and climate fluctuations (Whitmore, 1996), is now known to strongly influence the regional pattern of precipitation and radiation (Salati and Nobre, 1991; Shukla et al., 1990), playing an important role on the regulation of global greenhouse gases (McLain, 2001). Complex and intense plant-animal interactions of the Amazon, combined with rapid cycling of nutrients, are essential for the forest functioning (Whitmore, 1996), and play a key role on life-supporting energy and flows of materials. They also make this forest particularly vulnerable to external disturbances, especially those associated with removal of the vegetation. Indeed, deforestation, by threatening the current dynamic equilibrium of vegetation and regional climate (Shukla et al., 1990), as well as the diverse and complex links and connectivity among species, is certain to lead to important changes to regional and ultimately global climate, as well as to loss of the rich biodiversity of the region (Thomas et al., 2004).

Yet, over the last few decades, vast areas of the Amazon forest have been cleared for logging, pasture, and shifting agriculture in Brazil, where approximately 60% of the Amazon forest is located (Andersen et al., 1996; Andersen et al., 2002). Not only is Brazil the nation with more rain forest than any other (Whitmore, 1996), but it is also one

of the five megadiversity countries in the world (Mittermeier, 1988; Fearnside, 1999). At present, it is estimated that about 15% of the Brazilian Amazon forest is already cleared (Nepstad et al, 2002), as a result of a development process that was initiated in the 1960's, with state provision of road access and financial incentives designed to foster private investments in the region (Andersen, 1996). The adopted development approach for the region encouraged large, fairly unproductive areas, to be abandoned within a few years of occupation leading to increased clearing, and as a result, to increasing forest fragmentation (Moran, 1996).

Because they generate a direct, monetary income, logging, pasture, and agriculture activities are the most commonly perceived economic benefits of the Brazilian Amazon and have been used to justify the current pattern of forest exploitation. Very little or no attention has been paid to the value of protected forests in providing ecological functions such as carbon storage, biodiversity maintenance, and water cycling (Fearnside 1997a; Andersen, 1996; Andersen, 1997; Costanza et al, 1997). The neglect of these services is not puzzling, since they are primarily non-market goods, which provide little benefit to the profit-maximizing individual. The neglect is distressing, however, especially in the case of vital life support functions such as gas and climate regulation, which have been tremendously affected by the last few decades of clearing (Fearnside, 1997b).

This dissertation provides an assessment of the Brazilian Amazon's provision of ecosystem services and their contribution to the economy and welfare of local people. Ecosystem services are ecological conditions and processes that regulate and provide for human wellbeing (Daily, 1997). For the purpose of the analysis conducted here, a

dynamic systems model of the Brazilian Amazon forest was designed to integrate the functioning of the forest to human's economy and their social interactions, with a main focus on the contribution of the ecosystem goods and functions to human economy and welfare. The model, originally developed to simulate processes and patterns at a global scale (Boumans et al., 2002; Costanza et al., 2003), was adapted to run on a regional scale.

In this dissertation, I explicitly demonstrate not only the contribution of the ecosystem services to humans, but also explore the effects of the current use of natural capital and the resulting land cover changes on the decreasing availability of such goods and functions. I further explore the potential impact of an alternative that may be more sustainable over the long-term and that provides for a better compatibility between private preferences and public needs. The Brazilian Amazon rainforest is chosen because of the scientific challenges of comprehending this system under an appropriate level of complexity, as well as under appropriate temporal and spatial scales. Other important reasons include, but are not limited to: 1) the scientific need to enhance understanding of the relevance of processes of the forest to local, regional and global level processes; 2) the increasing development pressure and forest fragmentation threatening the largest, yet poorly understood, tract of tropical forest on Earth; 3) the importance of measures to be identified and put in place to protect this forest for current and future generations.

1.2. Research Hypothesis

Clearing of the Brazilian Amazon forest for main current anthropogenic uses provides economic benefits to local owners and their communities, contributing to their welfare. Removal of forest cover, however, incurs substantial losses of ecosystem

services and decreasing natural capital welfare-derived to local owners and communities. Furthermore, the Brazilian Amazon forest provision of non-market ecosystem services contributes not only to the welfare of landowners and communities throughout the entire region, but to those living elsewhere in Brazil and even on other continents. In summary, while the economic benefits of forest use are received exclusively at the local level, they incur forest fragmentation and consequent losses of ecosystem services that affect locals and non-locals alike. Similarly, if implemented, costs associated with measures to ensure forest conservation and its continued provision of ecosystem services are borne exclusively at the local level while benefiting those from other regions of the country and of the world.

- In this research, the primary hypothesis to be tested is that increasing land use change in the Brazilian Amazon, while incurring significant losses of ecosystem services, provides for an increasing monetary income and welfare of people of the region, as measured by both gross regional product per capita and welfare per capita.
- A secondary hypothesis is that, in the absence of incentives from regional and global beneficiaries of ecosystem services, rational land use decisions at the local level will lead to sub-optimal provision of these services from the global perspective.

1.3. Research Approach

To test these hypotheses, this dissertation will address three important questions:

- What is the contribution of the Brazilian Amazon ecosystem services both to economic production and human welfare in that region?

- What are the losses of ecosystem services attributed to deforestation given the current pattern of land use in the Brazilian Amazon and the overall effects of such losses on the economic production and human well-being in that region
- What are the needed incentives that must be put in place to foster a more sustainable use of the forest and ensure its preservation?

This dissertation explores short and long term effects of the current land use practices, acknowledging the complexity of different forces that result from land-cover changes and lead to further changes. Furthermore, it investigates the implementation of a potential alternative that takes into account the importance of the forest to the local population, and to those living elsewhere, as an alternative to discourage increasing land fragmentation and its effects on the provision of ecosystem goods and services. The basic premise is that success of such an initiative will most certainly depend on the provision of incentives, given the little enforcement power of local government and its inability to prevent forest destruction by measures associated with command and control regulations only.

1.4. Dissertation Outline

This dissertation is organized as follows:

Chapter 2 provides an overview of the Brazilian Legal Amazon, of pressing issues associated with land cover change and its long-term environmental impact. It also discusses the role of deforestation of tropical forests on global climate change, providing a brief review of the current debate on land use change and forestry projects under the Kyoto Protocol of the United Nations Framework Convention on Climate Change (UNCCC).

Chapter 3 provides the theoretical framework for the research described in this dissertation: the transdisciplinary integration of linkages between ecological, economic systems and social systems, as well as the use of modeling techniques to explore the dynamics of complex systems. It also provides an overview of models that have been developed for the Amazon region.

Chapter 4 discusses the development of the Regional Unified Metamodel of the Brazilian Amazon (RUMBA), presenting the theoretical and mathematical approach employed in the simulation of important processes within the model, as well as the changes done to account for its regional aspects. This chapter also describes the simulated scenarios and model parameters employed in their development.

Chapter 5 describes the calibration of the historical period of the model baseline scenario (1975 – 2005), presenting the datasets for some model variables, as well the assumptions and calculations used in their estimation when they were not readily available. Chapter 6 discusses the results of important variables simulated under the baseline scenario, as well as alternative scenarios, which are presented in graphical forms and followed by a brief explanation of the overall trends. Chapter 7 discusses the results, with a focus on the dissertation research questions and hypothesis. It also discusses caveats, uncertainty and future research needs. Finally, Chapter 8 summarizes the research, providing overall conclusions.

Chapter 2. Brazilian Amazon Overview: Definition, Current Land Uses, Long Term Impact and Potential of a Market-based Alternative

2.1. Definition

The Amazon river drainage basin is an area of approximately 6.6 million km² encompassing the countries of Brazil, Colombia, Ecuador, Peru, Bolivia and Venezuela (Wood and Skole, 1998). The Amazon forest, in turn, covers approximately 5.5 million km² of that area. Approximately two thirds of the Amazon basin and nearly 60% of the Amazon forest are located within Brazil (Andersen et al., 1996; Andersen et al., 2002), which has a forest area equivalent to one-third of the world's rain forest area (Verissimo et al., 1992).

In Brazil, this area is further described as the Classical Amazon and the Legal Amazon. The Classical Amazon refers to the northern portion of the country, an area of 3.5 million km² encompassing the states of Acre, Amapá, Amazonas, Pará, Rondônia, Roraima and Tocantins. This area represents nearly 40 percent of the Brazilian territory. The Brazilian Legal Amazon, a definition used for governmental planning purposes, is composed of the seven states of the Northern region, together with parts of the states of Mato Grosso and Maranhao (Andersen, 1996). The approximately 5,0 million km² area of the Brazilian Legal Amazon includes the forest of the northern and central Amazon, as well as the savanna and native grassland scattered throughout region and more distinctly located at the southern portion of the region (Chomitz and Thomas, 2001; Fearnside, 1993a, 1996; INPE, 2002; Pfaff, 1999; Serrao and Homma, 1993; Skole and Tucker, 1993). It is estimated that the forest area of the Brazilian Amazon area represents nearly

40% of the remaining tropical forests in the world (Peres, 2001). Figure 2.1. shows a map of the Brazilian Legal Amazon and its main vegetation covers.

FOREST COVER IN THE BRAZILIAN AMAZON, 1996

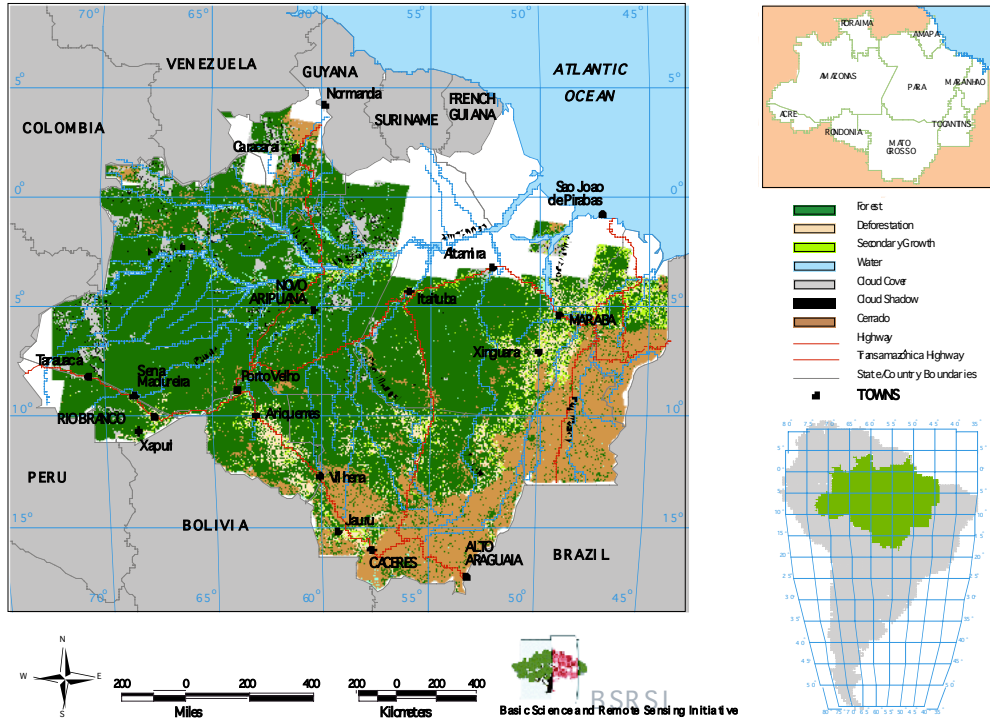

Figure 2.1. Legal Amazon, Brazil, Vegetation Cover (1992)¹. Source: Triopical Rainforest Information Center (TRFIC), Michigan State University (2004). Reprinted with permission.

2.2. Development and Deforestation

The large-scale deforestation of the Brazilian Amazon is the result of colonization of the region that began in the late 1960s (Salati, 1987; Moran, 1991). It started with the construction of roads (Salati, 1987; Moran, 1991, Moran, 1996; Pyne et al., 1996) and

¹ Map derived from the analysis of Landsat MSS and TM satellite images by TRFIC. Blank portions on the upper right and mid left areas of map are due to cloud cover in the images of these regions.

had the major objectives of alleviating population pressure in the Northeast of Brazil, strengthening the country borders in the region, and initiating the economic use of its natural resources (Pyne et al., 1996). Road construction was followed by investments designed to achieve socio-economic development of the region, such as internationally funded development projects, government sponsored colonization projects, fiscal incentives for extensive cattle ranching projects, farming and logging (Fearnside, 1987; Laurance et al., 1998). The result of this “policy of national integration”, as it would become known in Brazil, was increased migration to and deforestation of the Amazonian rain forest, particularly along roads (Fearnside, 1993a; Salati and Nobre, 1991), where large forest areas were converted into pasture (Moran, 1991; Uhl et al., 1988).

Studies have shown that the main causes of deforestation of the Brazilian Amazon are those associated with pasture, expansion of extensive, mechanized soy bean plantations, illegal logging activities, opening of roads, settlements designed for land reform, and invasion of land in the absence of tenure rights (Weber, 2003; Margulis, 2003; Brazil, 2004). The current absolute rate of the Brazilian Amazonian deforestation is the fastest in the world (Nepstad et al., 1994; Hecht et al, 1988; Laurance, 1998)_and has grown substantially over the last two decades (Alves, 1999; Ferraz, 2001) (Table 2.1). In the last decade alone, deforestation has proceeded at high rates (Fearnside, 2003), varying from 14 thousand km² per year in 1991 to over 20 thousand km² per year from 1995 to 1997 (Laurance, 1998). Between 2001 and 2002, approximately 25 thousand km² were destroyed in the Brazilian Amazon (Weber, 2003; INPE, 2004), a 40% increase from the 2000-2001 period. In 2003, preliminary estimates point to deforestation surpassing 21

Table 2.1. Deforestation in the Brazilian Legal Amazon

State	Deforested area (1E3 km2) ^a									Rate of Deforestation (1E3 km2) ^a						
	Amazon States	Original Forest Area (1E3 km2) ^b	% State Area ^c	1978 ^d	1989 ^e	1990 ^e	1995 ^e	2000 ^e	2001 ^e	77-88 ^f	88/89 ^f	89/90 ^f	94/95 ^f	99/00 ^f	00/01 ^g	01/02 ^g
Acre		152	100	9	10	10	13	16	16	1	1	1	1	1	0	-
Amapa		137	98	1	1	1	2	2	2	0	0	0	0		0	-
Amazonas		1,531	97	20	22	22	27	30	31	2	1	1	2	1	1	-
Maranhao		146	56	91	92	93	98	104	106	2	1	1	2	1	1	-
Mato Grosso		528	59	72	80	84	112	144	151	5	6	4	10	6	8	-
Para		1,184	94	132	139	144	169	200	207	7	6	5	8	7	5	-
Rondonia		212	89	30	32	34	46	58	61	2	1	2	5	2	3	-
Roraima		172	76	3	4	4	5	6	7	0	1	0	0	0	0	-
Tocantins		30	11	22	22	23	25	27	27	2	1	1	1	0	0	-
Legal Amazon		4,093		378	401	415	497	588	608	21	18	14	29	18	18	25
Deforestation (%)				9.2	9.8	10.1	12.1	14.4	14.9							

a. INPE (2004);

b. Kohlhepp (2001);

c; January;

d. August;

e. Decadal annual mean;

f. Annual mean.

thousand km² and possibly reaching 30,000 km² (Constantino, 2004). Overall, it is estimated that about 15% of the forest is already cleared (Nepstad et al., 2002).

2.3. Shifting Agriculture, Pasture and Logging

The large areas of pasture, which continue to account for most of the deforestation in the region (Fearnside 1993a; Fearnside, 1997b; Weber, 2003; Margulis, 2003; Kaimowitz et al., 2004; Brazil, 2004), differ substantially from the traditional “slash and burn” agriculture, the main economic activity practiced in this region until the 1960s. In shifting agriculture, small patches of forest are cleared, combining slashing of the understory, felling of selected trees and burning. Agricultural production follows until fertility declines, when the site is abandoned to succession (Whitmore, 1996; Noble and Dirzo, 1997). Practiced by small farmers for centuries, this kind of agriculture is considered a sustainable form of cultivation that can continue on the infertile soils of the rainforest provided that carrying capacity of the land is not exhausted (Toniolo and Uhl, 1995; Sponsel et al, 1996; Whitmore, 1996).

The impact of pasture, on the other hand, appears to be far greater than of the traditional “slash and burning”. This is not only because of its large area requirements, its high losses of ecosystem services relative to the short-term profits and low employment potential (Fearnside, 1980; Hecht, 1985; Moran, 1996), but also because of the soil degradation it incurs. Low soil fertility, extensive and repeated use of fire for graze maintenance and weed and woody species control, as well as overgrazing leads to pasture degradation and abandonment (Mattos and Uhl, 1994). Indeed, it is estimated that about 25% - 50% of original pasture areas in the Eastern AmazonAmazon are badly degraded or abandoned (Matos and Uhl, 1994; Weber, 2003). Furthermore, studies have shown that

pasture represents a major impediment to the growth of secondary vegetation (Uhl and Buschbacher, 1985; Nepstad et al, 1991), and concerns exist that areas cleared for pasture may not succeed into forest but instead develop into shrublands (Uhl et al., 1988). Yet, pasture remains widely implemented by small producers and large ranchers alike, which presumably reflects its economic rationality (Walker et al, 2000; Margulis, 2003). Furthermore, the fact that the cattle herd has grown substantially even in the absence of governmental subsidies (Andersen et al., 2002; Kaimowitz et al. 2004) shows the profitability of this economic activity in the Brazilian Amazon, if not its environmental viability. The significant increase in Brazilian meat exports from 1997 to 2003-- both a result of a significant Brazilian Real exchange currency devaluation and of an increasing international demand for safe meat-- is becoming an important incentive for pasture in the Brazilian Amazon (Kaimowitz et al., 2004). Overall, it is estimated that about 80% of the total cleared area in the Brazilian Amazon is due to pasture implementation (Weber, 2003; Brazil, 2004).

The pattern of natural resources use in the Brazilian Amazon has been labeled “growth without development”, one that is export-oriented, relying essentially on resource extraction and being highly subject to external drivers and their market oscillations (Moran, 1983). This is particularly true for the fast growing logging industry, which has over the last few years resulted in significant forest damage and fragmentation. Logging activities not only result in excessive environmental damage, but far more importantly, provide physical access to the forest, representing a major factor in further forest destruction and in the occurrence of fires in the primary forest (Laurance, 1998; Laurance, 2001).

A recent study by the Amazon Amazon Institute of People and the Environment (IMAZON) concluded that an estimated 10,000 to 15,000 km² of forest are logged each year increasing forest vulnerability to fire (Nepstad et al., 1999b). This area, on the same range as the amounts of the official annual deforestation values (ibid), remains categorized as intact forest for the purpose of national environmental accounting (Gerwing, 2002), despite the obvious depletion of timber stocks, severe ecological degradation and losses of important ecosystem services (Verissimo et al., 1992; Holdsworth and Uhl, 1997; Holmes et al, 2002).

2.4. Land Use and Fire Regime

Over the last thirty years, use of fire has become a common and widespread tool among farmers of the Brazilian Amazon rain forest (Setzer and Pereira, 1991). According to Nepstad et al. (1999a), fires are used in the Brazilian Amazon to clear land for shifting agriculture, pasture formation, and plantations (deforestation fires) and to maintain pastures and eliminate weeds (fires on deforested lands). Occasionally, these fires escape shifting agriculture and pasture areas and burn the fuel layer of the floor of primary or selectively logged forest (forest floor fires) (ibid).

While deforestation fires and fires on deforested land are primarily intentional, forest surface fires are primarily accidental fires (Nepstad et al., 1999a). Pasture creation and maintenance, as well as logging activities have contributed substantially to the increasing occurrence, extent and severity of forest surface fires especially during droughts (Laurance, 1998). Uhl and Buschbacher (1985, p.265, italics added) who documented fire spread from pasture into the open, dry, fuel rich and fire-prone selectively logged forest, described this phenomenon as a “*disturbing synergism between*

cattle ranch burning practices and selective tree harvesting". According to these authors, accidental fires escaping pasture areas cause great amounts of damage when invading the forest floor, changing the "*Amazonian forests... spectacular capacity to resist burning*" (Nepstad et al., 1998, p. 951, italic added).

Hence, it is no surprise that the Brazilian states with the highest rates of deforestation are also the ones where fire incidence is more severe (Skole and Tucker, 1993). Every year, fires escape from agricultural plots and pastures and burn thousands of square kilometers of the eastern and south Amazonian forest (Skole and Tucker, 1993; Cochrane and Schulze, 1998), in the states of Mato Grosso, Rondonia, Tocantins and Para.

The occurrence of droughts associated with El Niño-Southern Oscillation (ENSO) events in the last few years (Rasmusson and Wallace, 1983; Pyne et al., 1996; Uhl, 1998, Laurance, 1998; Kinnaird and O'Brien, 1998; Hammond and Steege, 1998; Beers, 1998; van der Werf et al, 2004) has aggravated the effect of the already existing Amazonian biomass burning phenomenon (Cochrane and Schulze, 1998), leading to catastrophic fires (Uhl and Kauffman, 1990; Kauffman, 1991; Kinnaird and O'Brien, 1998). Widespread fires occurred in the recent 1997-1998 El Niño event in the state of Roraima, burning an area of approximately 33,000 km², of which approximately 10,000 km² was estimated to be of intact forest (Beers, 1998; Hammond and Steege, 1998; Cochrane and Schulze, 1998).

Although fire occurrence in the Amazon has grown substantially over the last decade, the regional and global environmental effects of Amazonian fires are still poorly understood (Cochrane et al, 1999). According to Nepstad. et al. (1999b), during severe

El-Niño events, Amazonian ground fires may contribute to as much as 5% of annual carbon emission from all anthropogenic sources. A study by Barlow et al. (2003) based on large tree mortality and decline of biomass following fire in severely dry years, showed that these emissions could be equivalent to 10 – 12.5% of annual global carbon emissions from fossil fuels. More recently, van der Werf et al. (2004) estimated that emissions from fires in Central and South America during the 1997 – 1998 El Niño were responsible for 30% of total global fire emissions anomaly estimated as 2.1 ± 0.8 Pg of carbon (Table 2.2.). Still according to these authors, global fire emission represented $66 \pm 24\%$ of the CO₂ growth rate anomaly during that period. Lastly, not only do fires result in substantial amounts of aboveground carbon released to the atmosphere via combustion rather than decomposition (Seiler and Crutzen, 1980; Kauffman et al, 1998), but compared to other fire ecosystems, Amazonian fires also lead to the highest losses of nutrients ever measured (Kauffman et al, 1995).

Increasing anthropogenic-caused land fragmentation in the Amazon is leading to increased fire susceptibility and severity of fires in this region (Cochrane and Schulze, 1998), and is turning the Amazon forest into a fire-prone ecosystem (Mutch, 1970; Mueller-Dombois, 1981; Vitousek and D'Antonio, 1992; Uhl and Buschbacher, 1985; Uhl et al., 1988; Mueller-Dombois and Goldammer, 1991; Uhl and Kauffman, 1990; Kauffman, 1991; Holdsworth and Uhl, 1997; Uhl, 1998; Laurance, 1998; Kinnaird and O'Brien, 1998; Cochrane et al., 1999; Nepstad et al., 1999b). As deforestation increases, and with it the area of disturbed and fire-prone vegetation (Uhl and Kauffman, 1990; Holdsworth and Uhl, 1997), the frequency and severity of burning biomass might lead a system that is presently in equilibrium (Salati and Vose, 1984; Kauffman and Uhl, 1990)

to changes beyond our current comprehension. Indeed, there is an evident synergy between land use and climatic variability (Laurance 1998) that is only now becoming appreciated.

2.5. Regional and Global Long Term Impact of Deforestation

The equilibrium of the Amazonian rain forest as a system (Salati and Vose, 1984; Kauffman and Uhl, 1990) relates to the present vegetation cover and to the unique precipitation and water recycling of the basin (Salati and Vose, 1984; Salati and Nobre, 1991; Burgos et al., 1991). Significant clearing of the rainforest results in increased erosion and runoff, initial flooding in the lower portion of the basin, reduced infiltration, evapotranspiration and, most importantly, reduced precipitation (Salati and Vose, 1984; Salati and Nobre, 1991). Less available radiative energy (Salati and Vose, 1991) coupled with reduced soil water at the rooting zone (Nepstad et al, 1994; Nepstad et al, 1998; Laurance, 1998) combine to aggravate the reduced evapotranspiration of the changed landscape.

On a regional scale, severe deforestation is expected to lead to drastic changes on both the water and energy balance of the basin, causing changes in regional climate, potentially enhancing the current fire regime pattern due to expected warmer temperatures and diminished precipitation (Salati and Nobre, 1991; LBA, 2001; Moutinho, 2004). Severe burning of the biomass, in turn, is expected to modify physical and chemical properties of the aerosol and the cloud condensation nuclei (CCN) (LBA, 2002b; Andreae et al, 2002). Combined land clearance and biomass burning is expected to lead to imbalances in the meteorological cycle within the region and probably in the large-scale climate dynamics (Mylne and Rowntree, 1992; Zhang and Henderson-Sellers,

1996b; Roberts et al., 2001; Andreae et al., 2002; Werth and Avissar, 2002; LBA, 2002b). Lastly, not only deforestation and its fire regime have a major environmental impact, but ironically, they will also have an effect on the economic activities implemented, such as logging, pasture and agriculture (Moutinho, 2004).

On a global level, deforestation and fire emissions represent an important source of heat capturing gases and aerosols, ultimately aggravating global warming effects (Salati and Vose, 1984; Buschbacher, 1986; Detwiler and Hall, 1988; Salati and Nobre, 1991; Nepstad et al., 1991; Moran, 1991; Skole and Tucker, 1993; Skole et al., 1994; Reiners et al., 1994, Fearnside, 1997b; Laurance, 1998; Roberts et al., 2001). Global climate change, in turn, will most certainly have an ecological and physiological impact on the forest, possibly altering growing season length, biomass production, competition, causing shift in species and possibly extinction. Evidence to these effects have been shown by a recent study by Laurance et al. (2004), which points out to important changes in dynamics and composition of forests in central Amazonian forest over the past two decades. The study shows an accelerated productivity and dominance of faster-growing canopy and emergent trees, as well as a decline in slower-growing trees, most likely as a result of rising atmospheric CO₂ concentrations. These changes are important because by altering the carbon storage and species composition of the forest, they can reverse the overall carbon sink property of the Amazonian forests (ibid).

A global simulation model developed by Levy et al. (2004) points to such a trend. Levy's et al. model shows substantial loss of carbon in the Amazon due to climate change. According to the model, while most regions in the world are predicted to be

carbon sinks for the next century, the Amazon region was consistently a net source of carbon in all simulated IPCC SRES scenarios² (ibid).

2.6. Private Benefits of Forest Exploitation versus Social Benefits of Forest Protection

The Brazilian Amazon forest provides a variety of marketable products as well as unpriced services that benefit not only those who have property right over these resources in the region but also those living in the Amazon, elsewhere in Brazil and even on other continents. Private benefits of forest resources are normally obtained by economic returns of cleared forest, such as logging, crops and pasture activities. Social benefits, on the other hand, are normally associated with the functional properties of the intact forest such as the regulation of regional and global climate patterns, and provision of fundamental services that ensure the public well-being.

While private benefits of forest exploitation are valued through the market, social benefits--not easily valued by market methods, are often times disconsidered in decisions to use forest resources (Farnworth et al., 1983, Crook et al, 1998, Pagiola et al, 2002). Since they do not face the full social opportunity costs of their actions in terms of foregone ecosystem services, land owners are often compelled to use resources unsustainably (Barbier, 1994). They do so because the marginal private benefits of their use of cleared land (e.g. the monetary return of cultivation of crops) are not balanced against the marginal costs to society of forest loss (e.g. losses of important forest services). This is a typical case of market failure: because the economic values of important forest functions are not accounted for in decisions regarding forest use, more forest is likely to be cleared than is optimal (Barbier, 1994; Chomitz, 1999; Prugh, 1999;

² IPCC scenarios are based on 'storylines' defined as possible ways that socio-economies may develop over the next century.

Pagiola et al., 2002). In developing countries, market failure is often exacerbated by institutional and government failure, such as that associated with lack of regulatory institutions or the implementation of governmental policies that encourage depletion of natural capital for private benefits.

Given the pervasiveness of market, institutional and government failure in environmental public goods and services depletion, many alternatives have been attempted to ensure ecosystems protection. The most common initiative involves an effort by governments to protect and manage natural resources and forests, in particular, through institutional and policy intervention. At the national/local level, public intervention such as the establishment of protected areas and the overall use of command and control mechanisms are often limited by lack of sufficient information of what to protect, lack of funds and vulnerability to political pressures (Pagiola, 2002).

At the international level, many environmental treaties³, although an important effort in protecting natural resources, are also limited due to their lack in binding obligations (with the exception of Convention on International Trade and Endangered Species (CITES)), as well as absence of funding mechanisms (Bonnie et al., 2002). Lastly, environmental education and integrated conservation and development programs have also been attempted, with mixed results, as noted by Pagiola et al. (2002). As a general rule, the inability of these initiatives to address the fundamental issue of market failure has represented a main impediment for their effectiveness in protection of ecosystems (ibid).

³ Convention on International Trade and Endangered Species (CITES), UN Convention on Biological Diversity (CBD), UN Convention to Combat Desertification (CCD).

Clearly, this situation requires innovative measures and creative alternatives that could build a bridge between private and public interests.

2.7. The Potential of a Carbon Market for the Climate Regulation Service of Forests

The Kyoto Protocol of the United Nations Convention on Climate Change (UNCCC) and its market-based mechanisms offer an innovative and cost-effective means to mitigate the effects of the atmospheric concentration of greenhouse gases (GHGs), having the potential to enhance the protection of forests (Niesten et al, 2002). The Kyoto Protocol places binding limits or caps on GHGs from industrialized countries (Annex-B Parties) for the first commitment period (2008-2012), based on a baseline of the nations' GHG emissions in 1990 (UNFCCC, 1997). Market-based mechanisms that may be used by countries to meet their emissions caps include emissions trading and reallocation of targets among Annex-B parties, joint investment projects in Annex-B parties (so called Joint Implementation), and reductions through the Clean Development Mechanisms (CDM) in non-Annex B parties.

Although the significance of the contribution of land use change to the increasing atmospheric CO₂ levels and enhanced greenhouse warming is an issue that few would dispute, the inclusion of land use activities in an emission-trade framework, particularly that associated with carbon-sequestration and emissions activities, has been an extremely controversial issue in the negotiations of the Protocol (Smith, 2002). Many important political and technical issues have been at the core of the controversy, but important reasons for the controversy regarding carbon trading can be summarized as: 1) the fact that land use changes emissions and sequestration were not originally accounted for in the calculation of country's 1990 baseline; 2) the fact that countries different perceptions

were highly dependent on their own expectation of status of net seller/purchaser of emissions-reductions credits under the protocol (Bonnie et al., 2002). For instance, less economically developed countries (LEDCs) point to the fact that carbon trading might discourage industrialized countries to improve pollution controls, opting for the least expensive means of carbon reductions in non-Annex-B countries. LEDCs' concern is that their eventual pursuance of a carbon program will be the most expensive alternative, since the best carbon opportunities would be taken by non-Annex-B countries (Richards, 2000; Bonnie et al., 2002); 3) the absence of a comprehensive carbon measurements systems in many countries and the fungibility of credits produced by other means (Bonnie et al, 2002).

An example of the problematic aspects of land use changes within the context of the Kyoto Protocol from the standpoint of Annex-B countries can be seen in Articles 3.3. and 3.4. Under Article 3.3., Annex-B countries are required to account for net emissions/sequestration from afforestation, reforestation and deforestation since 1990, in the context of land-use conversions only. Article 3.4., designed to provide incentives for credits from forest, cropland and grazing-land management and revegetation, excluded deforestation emissions while establishing a cap limiting the credits from forest management (UNFCCC, 1997). Many fear that the likely outcome of this chapter is an overall reduction in the stringency of the Kyoto Protocol (Bonnie et al, 2002).

From the standpoint of both Annex-B and non-Annex-B countries, however, the most controversial aspect of the Kyoto Protocol in terms of the use of land use activities to mitigate CO₂ emissions, is its overall exclusion of projects addressing tropical deforestation through CDM projects (Bonnie et al., 2002, Niesten et al, 2002). Under the

CDM Annex-B countries are allowed to meet part of their emission reduction commitments (up to 1% of their 1990 emission times five) by projects sequestering carbon in non-Annex-B countries (Smith and Scherr, 2003). CDM is, at present, the only market-based mechanism allowed in non-Annex-B parties, where tropical forests are located, and one that could potentially deal with the significant sources of GHG emissions by tropical deforestation world-wide. Table 2.2 provides an overview of carbon emissions from Brazilian sources, as well as from the rest of the world giving a dimension of that contribution. According to the estimates provided in Table 2.2., the Brazilian Amazon deforestation-- a substantial source of GHG emissions (Salati and Nobre, 1991; Keller et al., 1991; Skole and Tucker, 1993; Dixon et al., 1994; Dale, 1997; Fearnside, 1997b; Nepstad, 1999b; Barlow et al, 2003)-- corresponds to more than twice as much as the emissions by fossil fuels in that country (EIA, 2003). On a global scale, tropical deforestation corresponds to about 15% - 25% of the CO₂ emissions from fossil fuels.

Currently, emissions and sequestration of atmospheric carbon by land use activities for the first commitment period (2008-2012) of the Kyoto Protocol under the CDM mechanism are limited to afforestation and reforestation (Niesten et al, 2002). Under that mechanism, Annex-B countries may purchase certified emission reductions (CER) from afforestation and reforestation projects implemented in non-Annex B countries (Brown et al, 2000). According to Niles et al. (2002), forest land-based opportunities for climate mitigation projects may also include: 1) protection of secondary and degraded lands; 2) reforestation of native forests; 3) avoided deforestation; 4) establishment of plantations on non-forest lands; 5) sustainable management of forests.

Table 2.2. Carbon Emissions From fossil Fuels and Tropical Deforestation

Source	Carbon Emissions (PgC yr ⁻¹)
Brazil	
Fossil Fuel	0.09 ^a
Amazon Forest Deforestation	0.20 ^b
Forest Fire (Average 1997 – 2001)	0.27 ^c
Forest Fire (El Niño year anomaly: 1997- 1998)	0.45 ^c
Global	
Fossil Fuel	6.50 ^a
Tropical Deforestation	0.96 ^d – 1.7 ^e
Forest Fire (Average 1997 – 2001)	3.53 ^f
Forest Fire (El Niño year anomaly: 1997- 1998)	2.13 ^f

a. EIA(2003);

b. Houghton (2000);

c. van der Werf (2004). Values for Central and northern South America;

d. Achard (2002). Maximum estimate of global net emissions from land-use changes in the tropics.

e. Malhi et al. (2002). Release from tropical deforestation.

f. van der Werf (2004).

Table 2.3. provides an estimation of the amounts of avoided emissions and of the economic benefits of three of these options for the tropical forest in Brazil and throughout the world, which highlights the significant contribution that these mechanisms may entail. Results show that a 15% avoided deforestation in Brazil, currently estimated as 25 thousand km² yr⁻¹, if compensated, would yield a net present value of about \$4.5 billion for the period 2003-2012 for that country.

Clearly, several important technical and scientific aspects of the climate mitigation projects by land use change represent a challenge for the implementation of such projects. First, it must be demonstrated that carbon credits obtained from such projects must be additional to the “business-as-usual” scenario (additionality); second, it must be demonstrated that project implementation is not leading to losses outside the project area (leakages); third, measures must be taken to prevent the carbon gain to be eventually lost as a result of major disturbances (permanence); fourth, a baseline scenario

(i.e. without the project case) must be developed, against which changes in carbon may be compared (baseline); and fifth, an effort must be made towards an accurate measurement of carbon forest stocks, of the overall emissions and credits from land use (carbon inventory, monitoring and verification) (Brown et al, 2000; Richards et al., 2000).

Table 2.3. Potential Carbon Mitigation and Associated Incomes through a Carbon-based Market Mechanism to Mitigate Climate Change^a

	Annual Deforestation (km ² yr ⁻¹)	Deforestation Halted	Carbon over 2003 – 2012 (MtC)	Net Present Value 2003- 2012 (US\$ million)
Brazil	25,540	3,831	603.4	4,598.4
Total	119,180	14,476	1,565.5	11,930.5
		Reforestation Rate (km ² yr ⁻¹)		
Brazil		7,500	103.1	713.7
Total		34,610	315.8	2,185.4
		Sustainable Agriculture Adoption Rate (km ² yr ⁻¹)		
Brazil		51,000	44.8	310.4
Total		496,000	420.6	2,910.8

a. Niles et al. (2002). Total of 48 major tropical and subtropical developing countries of Africa, Latin America and Africa, given a central price of \$10 per tonne of carbon and a discount rate of 3%.

Because the challenges described above are characteristic of all emissions-reductions in uncapped nations, they should not be used as a reason to exclude land use climate mitigation projects (Bonnie et al, 2002), particularly those associated with avoided deforestation as an eligible activity under CDM. Because tropical forests play such an important role in the global carbon cycle and its overall budget (Malhi et al.,

2002), having, as a result, a potential significant impact on the climate change, many argue that it must be considered in the effort to mitigate the effects the increasing atmospheric concentration of GHGs on the atmosphere. Avoided tropical deforestation may not only be a cost-effective means to mitigate carbon emissions, but may also lead to the protection of forest and its many ecosystem services, assisting host countries and their communities in their socio economic development (Hardner et al., 2000; Asquith et al., 2002). In that sense, it is important to point out that special attention must be paid to the social issues surrounding projects in developing countries, such as risks and benefits, as well as equity (Jong et al, 2000; Smith and Scherr, 2003).

Given the fact that CDM does not contemplate avoided deforestation projects, a new proposal presented at the recent COP9 – 9th Conference of the Parties to the United Nations Framework Convention on Climate Change (December/2003, Milan/Italy), suggests the creation of an alternative mechanism, the "Compensated Reduction", offering a possibility of expanding the options for offsetting carbon emissions (IPAM, 2003; Santilli et al., 2003). This proposal presented by a group of renowned Amazon scientists aims for countries to reduce the national level of deforestation to below a 1980-1990 level in order to receive post fact compensation, committing themselves to the stabilization and reduction of future forest deforestation rates.

Despite the many challenges posed by the implementation of CDM projects, or new mechanisms geared toward tropical deforestation, such as the proposed “Compensated Reduction”, it is important to consider that these mechanisms may have the potential to minimize the current market failure leading to the destruction of tropical forests worldwide, and of the Brazilian Amazon. At present, while there is a private

benefit that accrues to those exploiting the forest when they do so, there are no mechanisms that could potentially compensate such landowners for foregoing forest use—and benefiting people from elsewhere in the world. It is therefore unrealistic to expect landowners to bear the cost of providing well-being to the public in general by protecting the forest and its goods and services. In that sense, these market-based mechanisms may offer a viable tool to allow private preferences of individuals to be compatible with public needs (Norgaard, 1989).

The research presented in this dissertation explores the potential effect of a market-based mechanism to curtail carbon emissions from deforestation in the form of a monetary compensation to landowners to forego forest clearing. Sustainable management of resources, ecological economics and dynamic systems modeling--the theoretical and methodological framework on which the research is developed, are discussed at length in the following chapter. A brief literature review of models developed for the Amazon forest is also presented in that chapter.

Chapter 3. Ecological Economics and Dynamic Modeling

3.1. Sustainable Management of Natural Resources

One of the main problems and obstacles preventing a more sustainable management and use of natural resources is the overall lack of understanding regarding the functioning of large-scale natural systems and of the effects of human intervention on such systems (Daly, 1994; Holling, 1996). As a result, often times the management of ecosystems is based on too narrow a goal, too small scale and not considering the integrated economic, ecological and social effects and implications of management alternatives (Costanza et al, 2002). This is particularly the case with important ecosystems goods and functions, rarely taken into account in management decisions (de Groot, 1994) despite their significance to human lives. Yet, one of the most important reasons to conserve and manage ecosystems more carefully, and forest ecosystems in particular, is the benefits the ecosystem services provide to humans (Bishop and Landell-Mills, 2002).

Enhancing understanding of the interrelatedness, hierarchical complexity, dynamism, openness and creativity associated with ecosystems functioning (Norton, 1992), and the inherited uncertainties associated with human intervention on such systems (Ludwig et al, 1993; Holling, 1996; Cornwell and Costanza, 1999), has therefore become crucial to environmental management. The ultimate goal is the implementation of measures to preserve ecosystem integrity while maintaining sustainable benefits for human populations (Montgomery et al., 1995).

This is, however, a challenging goal. Not only because it demands a transdisciplinary integration of issues (Born and Sonzogni, 1995) at an appropriate temporal and spatial scale (Rastetter et al., 1992; Gardner, 1998; Peterson et al., 1998), but also because it requires the investigation of the characteristic dynamics associated with complex systems (Gardner, 1982; Maxwell and Costanza, 1993).

Ecological economics aims for a deeper understanding of the linkages between ecological and economic systems (Costanza, 1996a; 1996b) and offers a scientific framework for dealing with such complex questions. To ecological economists, natural capital, together with human and physical capital, represent the factors of production (land, labor, and capital) (Segura and Boyce, 1994). However, unlike conventional economics, ecological economics is based on the assumption that natural capital is not a mere factor of production (Prugh, 1999), but in addition the supporting goods and functions that enable life on the planet_ without it there can be no economy.

There are several implications to that statement. First, because economic production imports a flux of natural resources from the environment, and exports waste back to it, it is necessarily constrained by both the limits of natural capital supply and the waste assimilative capacity of the earth (Daly, 1996). That is, the economy is a subsystem within the Earth system (Daly, 1996; Costanza et al., 1997; Prugh, 1999; Lawn, 2001). Second, because knowledge, information and humans have to be embodied in physical structures, diminishing natural capital cannot potentially be substituted by increasing human or physical capital. That is, the factors of production are not substitutes, but instead complements (ibid). Hence, the limits to economic growth and welfare are not

determined only by technology and human ingenuity, but also by the inevitable scarcity associated with natural resources availability (Daly, 1999; Daly and Farley, 2003).

The assumption that diminishing natural capital could potentially be substituted by increasing human, social or physical capital implies the possibility of an ever-increasing creation of outputs, out of a stock of natural resources inputs that has been exhausted—a physical impossibility (Georgescu-Roegen, 1971; Daly, 1997; Cleveland and Ruth, 1997). The substitutability among inputs of production is the basis of the weak sustainability concept. The weak sustainability ignores the difference between stock-flow resources (*material cause*), which are transformed into what they produce, and fund-service (*efficient cause*), which are worn out from production but not transformed into what they produce (Daly and Farley, 2004). The stock-flow and fund-service are complements, not substitutes. The weak sustainability concept also ignores the natural limits to growth and the planet's absorptive capacity for waste. The strong sustainability concept, on the other hand, is based on the limits to substitution (Barbier, 1994), and on the fact that natural and manufactured capital are largely complementary (Prugh, 1999), and hence, that there can be no economic production without natural capital inputs.

While the advent of ecological economics has provided the theoretical framework through which transdisciplinary problems can be assessed, advances in computer techniques and accessibility in the last few decades, on the other hand, have enabled the development of dynamic systems models and are allowing scientists to explore the long-term assessments of landscapes under human intervention (Huston et al., 1988; Costanza et al, 1993; Bockstael, 1995). Dynamic systems models are a particularly useful tool to simulate ecosystems processes and patterns and their responses to different management

options (Costanza et al, 1990). Models enhance understanding of ecological functioning and the effects of human-made decisions on ecosystems, helping the investigation of alternative and more sustainable scenarios (Rykiel, 1996; Van Winkle and Dale, 1998; Costanza et al., 1990).

However, while several models offer great insights from a science, management and policy -making standpoint, they are rarely designed to assess the contribution of natural capital to humans and its value to the human economy. And even when the value of natural capital is acknowledged, it is seldom taken into account in the assessment of more efficient management alternatives (Kramer et al., 1992). This dissertation represents an effort to assess such contribution and to investigate a management scenario that takes into account the continued provision of natural capital.

3.2. Model Definition, Purpose and Uses

A model is a “*simplified concept within the human mind by which it visualizes reality*” (Odum, 1994; Odum, 1996). It is, above all, a synthesis of elements of knowledge about a system (Jorgensen, 1997; Dale and Van Winkle, 1998). A model is of significant aid in the process of enhancing understanding of complex systems (Rykiel, 1996; Van Winkle and Dale, 1998; Costanza and Ruth, 1998), and in the analysis and prediction of systems dynamics (Rykiel, 1996; Costanza et al., 1990). Moreover, models can be used to educate scientists, local government officials and stakeholders. Indeed, Oreskes et al. (1994, italics added) asserted that “*the primary value of models is heuristic*” (p. 641). A model can also be used to build consensus among stakeholders groups (Costanza, 1996a; Costanza and Ruth, 1998) and in doing so, to provide public support for policy decisions.

Models enhance comprehension and provide insights in the choices of alternative actions (Costanza and Ruth, 1998). This is particularly the case of mental models, which humans routinely use, by linking crucial parts of a problem together and leaving out irrelevant and or detailed aspects of it, in order to make informed decisions about a situation (ibid). From a more scientific standpoint, conceptual models, in particular, widely used to organize existing information, are crucial in indicating our current knowledge of the system, and to point out gaps of information and where research should focus (Van Winkle and Dale, 1998). Such models are based on the identification of essential components, their relationship, changes in the objects or their connections that will affect the functioning of the system, and the identification of the research goals and needs to further enhance understanding of the subject in question (Engelbart, 1962; Järvelin and Wilson, 2003).

In terms of landscape processes, such as those associated with ecosystem protection and management, the three most important types of models are empirical, mechanistic and systems models (Lambin, 1994). Empirical models are based on stationary processes, that is, the assumptions that relationship between variables and processes will hold into the future. Such models are strongly based on the observation and field-collected data. Mechanistic models, on the other hand, are based on the assumption that we understand the processes by which the system operates, which in essence, follows scientific laws and can be described by simple equations. System models, although also based on scientific laws, focus on the interactions among all parts of a complex system, often sacrificing details and focusing on relevant aspects of an issue, in order to simulate the system in its entirety (ibid).

System models are useful tools to investigate the system's response and sensitivity to direct and indirect feedbacks and loops, and to predict different scenarios given different policy choices (Costanza et al., 1993). This is particularly the case of modeling ecological economic systems, where purposes normally range from understanding of system behavior, development of realistic applications, and to investigating policy alternatives (Costanza and Voinov, 2002). Although, these models are often built with the goal of understanding, predicting and modifying nature, it is important to point out that, albeit desirable, it is not possible to maximize realism (simulating system behavior in a qualitative realistic way), precision (simulating system behavior in a quantitative precise way) and generality (representing a broad range of system's behavior) (Levins, 1966; Costanza and Ruth, 1998). Levins (1966)_ in what became an extremely influential analysis of scientific modeling, pointed out the necessary trade-offs between such features (Orzack and Sober, 1993). More recently, Levins (1993, p. 68, *italics added*) emphasized that

... Models do not fall into mutually exclusive classes but lie on a multidimensional continuum. Three of these axes are generality, realism and precision. Others are manageability and understandability... The strategy of model building consists of deciding how to move along this continuum.

Hence, the choice of which type of model to pursue depends on the fundamental purposes of the model to be built (Costanza et al., 1990; Costanza and Ruth 1998). For example, if the purpose of the model is the understanding of a system, at very broad and aggregate levels, conceptual models and those characterized by high generality may be appropriate (i.e. simple linear and non-linear economic models). If, on the other hand,

precision is desired, one should apply high resolution and simple relationships within short time frames (i.e. input-output models). Lastly, if realism is required, dynamic, non-linear systems models are usually built to provide a realistic description of the particular system to be studied (i.e. a site specific model) (Costanza et al., 1993; Costanza et al, 1996). In essence, depending on the purpose of the model, one feature (realism, precision or generality) must be sacrificed in favor of the other two.

The dynamic systems model developed for the research presented in this dissertation integrates different aspects of a site-specific ecosystem—the Brazilian Amazon—with the goal of enhancing understanding of that system behavior and furthermore, of anticipating its response to different, opposing policy alternatives. In that sense, it emphasizes realism in detriment to generality and precision.

3.3. Dynamic Systems Models and Econometric/Statistical Models

Dynamic systems models are powerful learning tools, a great way to organize ideas about a specific problem to be investigated, and most importantly, of depicting the inherent dynamics associated with ecological, economic and social systems. They have a specific representation of future states or conditions (Haefner, 1996), and besides depicting our current knowledge of a problem, often allow the investigation of alternative scenarios given different policy options (Costanza and Voinov, 2002). The development of such models begins with a detailed identification of the system to be investigated and of the questions to be addressed, followed by determination of sectors, stocks, flows, driving variables, loops and feedbacks representing the system in study (Ford, 1999). In such models, the establishment of direct and indirect connectors between state and

auxiliary variables depicts the links and relations between and within the different sectors of the model (ibid).

Equations and random numbers are employed in dynamic systems models to describe some expected behaviors that are well documented in the literature. Time series and other indicators are employed whenever sufficient data are available (Hendry, 1997). In the absence of data, relations are built to mimic the qualitative aspects of the problem, as described in the literature, or by formulated by extensive knowledge of the problem. External shocks are usually depicted by means of stochastic parameters or functions, which provide the system with a random component, a helpful tool in investigating the system behavior. Time lags (often useful in phenomenon associated, for example, with delayed effect of policies or measures) can also be employed by means of attractors. They are very useful in processes leading to complex dynamics and instability (Haefner, 1996). Extensive documentation of processes described in the model, as well as of assumptions made in its construction enhances one's ability to understand the system investigated, as well as model performance and its limitations.

Econometrics/statistical models combine theory with statistical data in a formal quantitative framework (Lambin, 1994; Hendry, 1997). While, on one hand, their limitation to a certain field of study leads to their better acceptability within the scientific/policy arena, on the other hand it incurs a significant constrain for the assessment of a problem whose important variables, and their direct and indirect relations can not be described within the framework of such models. Probably the main difficulty in building these models is precisely the establishment of the somewhat intuitive

selection of variables to be correlated and their quantitative relationships (Costanza and Ruth, 1998).

The relevance of statistical models, in turn, is their ability to summarize data, to enable one to interpret empirical evidence, to provide competing explanations for a particular phenomenon, and finally to serve as a vehicle of accumulation and consolidation of empirical knowledge (Hendry, 1997). Limitations of such models are often associated with the extent of one's knowledge about the modeled system (as in all other modeling approaches) and the static, equilibrium-oriented character of most of these models. Other shortcomings are great reliance on time series data that are often in short supply, highly aggregated, heterogeneous, non-stationary, and time-dependent interdependent. Stochasticity in random coefficient models is often limited by use of constant parameters in equations (Hendry, 1997).

In summary, although both approaches are useful and relevant given different needs, the great advantage of dynamic models over statistical models is their use of our scientific knowledge of a system, and as a result, its transferability to new applications (Costanza and Ruth, 1998). Because their construction is based on fundamental concepts which are present in other systems, dynamic models, unlike the statistical ones, do not rely on historical or cross-sectional data to have relationships identified or demonstrated, such as those observed on regression equations derived from statistical models (*ibid*).

3.4. Models and Public Policy

Computer models can be a great tool to overcome obstacles that prevent a better, more effective linkage between environmental science and policy, by enhancing the understanding the dynamics associated with biophysical environment, the human society

and economy (Slocombe 1993a, 1993b). They can be used either to explicitly show the linkages and responses of the system to different interventions-- and as a result to different scenarios of policies, or to help in the investigation of areas where more research needs to be done (Rykiel, 1996; Costanza et al., 1990). Furthermore, models can be used to enhance public involvement and to build consensus toward policy-making (Costanza and Ruth, 1998).

Watershed modeling and management, for instance, has gained an important role in the last few decades, particularly because of its holistic approach of integrating environment and development. The geographical scale of a watershed provides the framework for gathering and interpreting information, to observe cumulative changes resulting of certain land use practices and to support decision-making interventions and public participation. Watershed models describe complex interactions of physical, hydrological and biogeochemical processes by means of empirical or theoretical mathematical relationships, with the goal of providing insight to watershed management, conflict resolution, protection of ecological benefits and control of local resources (McGinnis et al., 1999). Models of ecoregions for ecological studies are also an important way to assess ecosystems when the focus is the similarity of ecological patterns, as opposed to the topographic boundaries of a watershed (Omernik and Bayley, 1997).

Regardless of the spatial unit adopted, as a general rule, the use of models to assess structural and functional properties and behavior of ecosystems, as well as their changes due to human uses, enables scientists, policy-makers and the public to pursue a systemic, broad-scale perspective. In that sense, they are a great outcome and a promising field. However, because models are often based on simplification and, moreover, on

uncertainties associated with responses of human and ecological systems, modeling-derived policies require an assessment of the model outcomes in terms of its limitations and reliability. Furthermore, implementation of policy alternatives derived from models demands the application of precaution and adaptive mechanisms to respond to surprises or unexpected events resulting from policy intervention (Holling, 1996; Cornell and Costanza, 1999). Experience has shown that apparent successful management of a single variable tends to lead to less resilient and changed ecosystems (Holling, 1996; Peterson et al, 1998; Gunderson et al., 2002). Hence, management should be based on the complexity of interactions and on the different successional stages necessary for diversity, especially if protected areas are too small or topographically limited to have these processes occurring naturally (Gilbert 1980).

This is particularly the case of policies employed to reduce ecosystem's variability (i.e. natural disturbances) that, albeit successful in the short-term, often lead to eventual destructive disturbances due to the ecosystem's loss of resilience (Holling, 1996). As they occur at different scales, disturbances are often a source of cross-scale interaction among different processes, with fine-scale changes driving broad scale responses. Understanding the combination of these forces has a very practical effect on our effort to describe landscape cover and its changes in a computer model, and on deriving and investigating potential management alternatives.

3.5. Models of the Amazon

Increasing awareness of the importance of the Amazon forest, as well as of concern about the potential effects of its deforestation has led scientists to develop many computer models for the region in the last few decades. Table 3.1. at the end of this

chapter provides a brief review of such models, which I aggregated into Models of Deforestation and its Drivers, Models of Deforestation and Cost-Benefit Analysis, Models of Deforestation and Ecosystem Services and Models of Deforestation and Climate Change. This list is not intended to be an exhaustive list, but an overall view of the modeling effort so far. Models included in this list range from conceptual models describing important linkages of the phenomenon studied to process-based simulation models for interacting land-ocean-and atmosphere processes. Although some models address both the causes (i.e. drivers) of deforestation, as well as its effects (i.e. losses of ecosystem services), for the purpose of classification here described, models are grouped according to their main purpose, as specified on the documentation of the referred models.

3.5.1. Models of Deforestation and its Drivers

Generally speaking, models of Deforestation and its Drivers investigate the economic and sociological processes that drive deforestation. According to Kainowitz and Angelsen (1998) the variables affecting deforestation can be separated into three different levels: the underlying causes of deforestation, the immediate causes of deforestation and the direct sources of deforestation. The underlying causes of deforestation are generally macro level variables, such as income, population and macroeconomic policies. The immediate causes of deforestation, in turn, are those that determine agent's decisions among a set of variables, such as institutions, infrastructure, markets and technology. Finally, the direct sources of deforestation represent the agents of deforestation themselves, such as farmers, ranchers, loggers, etc (ibid). The discussion of the Deforestation Drivers models in this section follows this framework of analysis.

Like the great majority of deforestation models for other regions of the world (Kainowitz and Angelsen, 1998), most deforestation models for the Amazon are based on econometric analysis (i.e. regression). The spatial scale of these models is often the entire Brazilian Amazon region (Reis and Guzman, 1994; Andersen, 1996; Pfaff, 1999; Ferraz, 2001), with a few exceptions. Jones et al. (1995), for instance, documents a regression model based on farm-level scale. Among the same “Deforestation Drivers” category, but using a different methodology, is a model that investigates the expansion of cattle herding using spatial economics/spatial pricing (Faminow, 1997), and a model that simulates the effects of economic, infrastructure and governmental policy variables using computable general equilibrium approach (Cattaneo, 2001; Cattaneo, 2001).

At the macro level, and according to Cattaneo (2001), devaluation of the currency aimed to balance national accounts has the double benefit of decreasing deforestation rates in the Amazon and of potentially being used to partially offset the increasing deforestation associated with decreasing transportation costs. And while there is no question that availability of governmental credits has played an important role in the implementation of cattle ranching, the fact that pasture remains the preferred economic use of land, even in the absence of subsidies, shows that even if subsidies are important, they alone can not be blamed for deforestation (Andersen et al, 2002). The role of population and migration is far more difficult to assess, and subject to great controversy. Pfaff (1999) found no evidence of population density playing a role when other variables are considered, although his results also showed that first migrants in a region tend to create a much higher environmental impact than later migrants. Faminow (1997) associated the rapid growth of urban population in the region and of its increasing

purchasing power to the creation of a huge demand for cattle products, and as a result, to the expansion of pasture in the region. Andersen (1996), on the other hand, showed that population growth in a particular area is mostly associated with population growth of a neighboring area. Still according to that study, people tend to move to areas with higher levels of per capita income and higher rate of growth of per capita income (ibid).

At the intermediate levels, variables such as density of paved and unpaved roads, transportation costs and price of cattle head together with soil characteristics, land prices and regulation of tenure regimes have shown to be significant deforestation drivers (Pfaff, 1999, Ferraz, 2001, Cattaneo, 2002; Cattaneo, 2002). The impact of improved technology for agriculture and pasture in the region appears to have dubious effects. By improving short-term gains for producers, improved technology may lead to increasing deforestation in the long-run (Cattaneo, 2001), and therefore must be carefully examined. An overall consensus exists on the effects of the expanding road network, which, by providing accessibility to the forest and to market for forest products, plays a crucial role in the increasing deforestation rates (Carvalho et al, 2001; Nepstad et al, 2002).

Lastly, at the level of direct sources of deforestation a model developed by Scatena et al. (1996) based on field survey showed that the choice on the length of fallow appear to be very dependent on cost of land clearance and preparation. Farmers are inclined to compensate the losses in production associated with several short rotations with the reduction in site preparation costs that the young secondary forest provides.

In reviewing the results of these models, it becomes apparent that a combination of both underlying causes and immediate causes combine to drive deforestation in the Amazon, although immediate causes are more often described as the most significant

variables in the deforestation. Indeed, this conclusion is supported by Anderson (1996) who asserted that although the federal government played a key role in initiating deforestation by means of infrastructure provision and fiscal incentives, it may have lost control of it to local market forces.

3.5.2. Models of Deforestation and Cost-Benefit Analysis

The costs and benefits of deforestation, in particular those associated with subsidies and road construction, has been one of the areas of analysis on which many scientists have focused in the last few years. These models can be divided into two major categories: the econometric models and the empirical, mechanistic models. In the first category, Andersen and Reis (1997) showed that subsidies can be beneficial for economic development of the region, and a good trade-off between economic growth and deforestation; the opening of a new road, on the other hand, represents a far less favourable trade-off, according to that study. The recent Anderson et al. (2002) expands on the former work by Anderson and Reis (1997), using a dynamic and spatial econometric model based on county-level data for the entire Brazilian Amazon from 1970 to 1996, with a focus on the effects of some incentives on both economic growth and forest protection. Their results show that while construction of roads in the highly settled areas may be beneficial for both economic development and forest protection, the construction of roads in pristine areas have the opposite effect, being both economically wasteful and environmentally unsound.

The models developed by Carvalho et al. (2001) and Laurance et al. (2001) offer two important contributions to the debate associated with improved infrastructure for the Brazilian Amazon, with the implementation of the project “Avança Brasil” (Forward

Brazil). “Avança Brasil” is a US\$45 billion infrastructure investment project proposed by the Brazilian government focusing on road paving, river channeling, port improvements and expansion of energy production, to be implemented over the 2000-2007 period (Carvalho et al., 2001, Laurance et al., 2001). Both models take into account the observed historical spatial pattern of deforestation alongside roads. Carvalho et al. (2001), using a spatial model, estimated the planned 6,245 km of paved highways proposed by the “Avança Brasil” project to cause around 120,000 – 270,000 km² of additional deforestation alongside such roads. According to these authors, the overall deforestation for the Brazilian Amazon would increase from the current 14% levels to about a third of the total area in the next 20 to 30 years. The model designed by Laurance et al. (2002) simulates two scenarios of deforestation based on the “Avança Brasil” project with different assumptions: the optimistic scenario resulted in extensive deforestation, more so along the southern and eastern portion of the basin, but with great fragmentation throughout the central and northern portions of that region; the non-optimistic scenario, in turn, predicted great forest degradation by the year 2020, with only few pristine areas remaining in the western portion of the Brazilian Amazon region.

3.5.3. Models of Deforestation and Ecosystem Services

A very limited number of models address the ecological effects of deforestation on the provision by the forest of ecosystem services not directly associated with climate regulation. The models here described document the effects of forest fragmentation on biodiversity, forest resilience to disturbance such as fire, its carbon sink capacity, erosion control and nutrient cycling. Two models describing fragmentation employed landscape ecology methods to assess the impact of forest clearing on greenhouse gas emissions and

on communities and faunal diversity. The first model provided an estimation of net committed emissions from forest fragmentation, according to different patterns of fragmentation (Laurance, 1998). The second model showed the vulnerability of rare plant species in the heavily degraded and fragmented landscape and the dramatic difference between high (95%) and very high (99%) levels of habitat clearing (Laurance, 1999). Dale et al. (1994) using a model combining gap-crossing ability and area requirement for Neotropical animals concluded that species requiring large areas and crossing only small gaps are more affected by the forest fragmentation.

Fearnside (1996), using a markov transition probability model designed to estimate the amount of biomass taken up by the secondary forest in abandoned areas, found biomass numbers that were more than the double the number used by Intergovernmental Panel on Climate Change (IPCC) in estimating emissions from deforestation. Potter et al. (2001) estimated the fluxes of water, carbon and nitrogen gas for two sites in the Amazon. Their results have a good potential of being scaled up for the entire region, given improvements in classification of land cover, land use and soils, and furthermore, in the knowledge of biotic and abiotic emissions that lead to green housing effects. Another model by Nepstad et al. (1998), based on a integrating the effects of drought and logging on forest susceptibility to fire, has shown to be an important predictive tool and has supported government effort to coordinate enforcement activities designed to prevent large-scale, catastrophic fires during the dry season.

Lastly, a model by Portela and Rademacher (2001) was the only dynamic systems model directly addressing the losses of forest ecosystem services due to different patterns of land use. This innovative model-- shown as Appendix A on this dissertation, provides

a monetary value for the services assessed (i.e. its carbon sink capacity, erosion control, nutrient cycling and biodiversity) and compares that to the annual revenue derived for land uses for which the forest is cleared. As the primary author of such a study, I have done substantial research and data collection, have developed and described most of the sectors and contributed to a large extent to documentation of model results.

3.5.4. Models of Deforestation and Climate Change

This is by far the most extensive, comprehensive and sophisticated type of model developed for the Brazilian Amazon forest. These models, mostly Global Circulation Models (GCM) developed by different laboratories, investigate the effects of the Amazon deforestation, under different resolutions, parameterizations and simulation length. Overall, results show that forest cover replaced by a human-land use results in regional reduction of evapotranspiration and precipitation, as well as in increase in surface temperature. Most results show that deforestation causes a local reduction in precipitation of 146 to 638 mm yr⁻¹, which are equivalent to 6 to 27% of the current estimated mean annual rainfall of 2,328 mm yr⁻¹ (Marques et al., 1980). Only one study showed no net reduction (Dickinson and Henderson-Sellers, 1998) with another showing net gain (Polcher and Laval, 1994). The effects of deforestation on evapotranspiration appear, in turn, to be even more dramatic than that on precipitation. According to most results, deforestation causes a local reduction in evapotranspiration of 73 to 730 mm yr⁻¹ that are equivalent to 6 to 58 % of the current estimated mean annual values of evapotranspiration (Marques et al., 1980). The decrease in evapotranspiration and precipitation results in reduced moisture convergence into the region. Furthermore, increased temperature, ranging from 0 to 3.8 °C, was also observed.

Most results of models show that deforestation has an important impact on regional climate pattern. An impact on global climate, although not certain, is also expected. A recent model by Werth and Avissar (2002) showed that deforestation of the Amazon causes noticeable and significant response in remote areas of Earth, most noticeable on precipitation patterns, which, in turn, may affect water resources and agriculture productivity on such areas.

In summary, current models of the Amazon region have contributed substantially to enhancing understanding of leading forces and of patterns of current use of resources in that region and of its potential environmental impact. They have, however, addressed issues associated with environmental-human interactions by focusing on either the ecological or economic modeling approach to such connections. The unique contribution of the Regional Unified Metamodel of the Amazon (RUMBA)--developed for the research presented here, is the integration of dynamic feedbacks among the ecosystem goods and functions with the economic production and human welfare within the region. In the following chapter, I describe in detail the development of RUMBA, in terms of the chosen modeling approach for processes and patterns described in the model, as well as for their connections and interactions. This chapter also discusses the extensive research done to inform model parameters.

Table 3.1. Models of the Amazon Forest

Subject/Author	Model/Method	Main Purpose	Scale
Deforestation and Its Drivers Models			
Reis and Guzman (1994)	Econometric analysis/Regression	Deforestation, CO2 emissions, spatial growth of population and economic activities	Regional (cross-section data at municipal level)
Dale et al. (1994)	Dynamic ecological-land tenure analysis	Land use practices and typical land use conditions	Farm level
Jones et al. (1995)	Econometric analysis	Economic and environmental aspects of farming practices	Farm level
Andersen (1996)	Econometric analysis	Determinants of deforestation	Regional (cross-section data at county level)
Scatena et al. (1996)	Conceptual model based on field survey	Factors influencing cropping and fallowing practices on small farms	Farm level
Faminow (1997)	Aggregate spatial economics/Spatial pricing	Determinants of the expansion of the cattle herd	Regional model
Pfaff (1999)	Econometric analysis/Regression	Determinants of deforestation	Regional model/county level
Cattaneo (2001) Cattaneo (2002)	CGE (computable general equilibrium)	Effects of real exchange rate, agricultural tax and support policies, transportation costs, land tenure and technological changes on deforestation	Regional model
Ferraz (2001)	Econometric analysis	Determinants of agriculture expansion and deforestation	Regional model

...Table 2.1. Continued.

Subject/Author	Model/Method	Main Purpose	Scale
Deforestation and its Cost-benefit Models			
Andersen and Reis (1997)	Econometric analysis	Cost-benefit analysis of deforestation	Regional (urban and rural sectors)
Andersen (1997)	Econometric analysis	Cost-benefit analysis of deforestation	Regional
Rocha et al. (2002)	Econometric analysis	Assessment of forest concession	Regional
Andersen et al. (2002)	Econometric analysis	Trade-off between land clearing and economic growth	Regional
Carvalho et al. (2001)	Empirical/Mechanistic model	Alternatives for large-scale conservation based on frontier governance	Regional
Laurance et al. (2001), Fearnside and Laurance (2002), Schwartz (2002)	Empirical/Mechanistic model	Deforestation and forest degradation as a result of implementation of a mega development/infrastructure project (Avana Brasil)	Regional
Deforestation and Ecosystem Services Models			
Dale et al. (1994)	Spatial model	Effects of deforestation in the faunal biodiversity	Regional
Fearnside (1996)	Markov matrix of transition probabilities	Estimation of carbon stocks in vegetation replacing forests	Regional
Nepstad et al. (1998)	Spatial modeling	Forest susceptibility to fire	Regional
Laurance et al. (1998)	Spatial modeling	Effects of forest fragmentation on greenhouse gas emissions	Regional
Laurance et al. (1999)	Random-clearing model	Effects of habitat loss on plant community and populations	Regional
Portela and Rademacher (2001)	Process-based simulation model	Effects of different land use patterns on the value of ecosystem services	Regional

...Table 2.1. Continued.

Subject/Author	Model/Method	Main Purpose	Scale
Nepstad et al. (2002)	Empirical/Mechanistic model	Alternatives for large-scale conservation based on frontier governance	Regional
Cochrane (2003)	Conceptual model	Positive and negative feedbacks controlling fire processes in tropical forest	
Deforestation and Climate Change Models			
Hendersons-Sellers and Goornitz (1984)	CCM, BATS ^a	Effects of deforestation on climate variables	Regional
Dickinson and Henderson-Sellers (1988)	CCM, BATS ^a	Effects of deforestation on climate variables	Regional
Lean and Warrilow (1989)	UKMO, GCM ^b	Effects of deforestation on climate variables	Regional
Sud et al. (1990)	GLA, GCM, SiB ^c	Effects of deforestation on climate variables	Regional
Shukla et al. (1990), Nobre et al. (1991)	COLA, GCM, SiB ^d	Effects of deforestation on climate variables	Regional
Dickinson and Kennedy (1992)	CCM, BATS ^a	Effects of deforestation on climate variables	Regional
Hendersons-Sellers et al. (1993)	CCM, BATS ^a	Effects of deforestation on climate variables	Regional
Lean and Rowntree (1993)	UKMO GCM ^b	Effects of deforestation on climate variables	Regional
Polcher and Laval (1994)	LMD GCM, SECHIBA ^e	Effects of deforestation on climate variables	Regional
Fearnside (1995)		Effects of climate change on forests and forestry	Regional
McKane et al. (1995)	MBL-GEM ^f	Effects of global change on carbon storage	Regional
Walker et al. (1995)	GLA, GCM, SiB ^c	Effects of deforestation on climate variables	Regional
da Rocha et al. (1996)	SiB-1D	Effects of land cover soil water stress into precipitation	Regional
Zeng et al. (1996)	CCM, BATS ^a	Effects of deforestation on climate variables	Regional
Zhang et al. (1996b)	NCAR, CCM, BATS ^g	Effects of deforestation on climate variables	Regional

...Table 2.1. Continued.

Subject/Author	Model/Method	Main Purpose	Scale
Sud et al. (1996)	GLA, GCM, SiB ^c	Effects of deforestation on climate variables	Regional
Lean et al. (1996)	UKMO GCM	Effects of deforestation on climate variables	Regional
Lean and Rowntree (1997)	UKMO GCM ^b	Effects of deforestation on climate variables	Regional
Hahmann and Dickinson (1997)	CCM, BATS ^a	Effects of deforestation on climate variables	Regional
Kleidon and Heimann (1999)	GCM	The role of deep-rooted vegetation and effects of its removal on climate variables	Regional
Potter et al. (2001)	Process-based simulation model	Water, carbon, and nitrogen gas fluxes	Regional
Costa and Foley (2000)	GENESIS AGCM	Effects of deforestation and double atmospheric carbon on climate variables	Regional
Werth and Avissar (2002)	NASA-GISS model II GCM ^h	Effects of land cover changes in the Amazon on local and global climates	Global

a. Community Climate Model (CCM), Biosphere Atmosphere Transfer Scheme (BATS).

b. United Kingdom Metereological Office (UKMO) Atmospheric Global Climate Models (AGCM).

c. Goddard Laboratory for Atmosphere (GLA), General Circulation Model (GCM), Simple Biosphere Model (SiB).

d. Center for Ocean-Land Atmosphere Interactions (COLA), General Circulation Model (GCM), Simple Biosphere Model (SiB).

e. Laboratoire de Météorologie Dyanmique (LMD), Shématisation des Echanges Hydriques a l'interface entre le Biosphère et l'Atmosphère. (SECHIBA)

f. Marine Biological Laboratory (MBL), General Ecosystem Model (GEM) General Circulation Model (GCM).

g. National Center for Atmospheric Research (NCAR), Community Climate Model (CCM), Biosphere Atmosphere Transfer Scheme (BATS).

h. National Aeronautical and Space Administration (NASA), Goddard Institute for Space Studies (GISS), Global Climate Model.

Chapter 4. GUMBO/RUMBA Model Development

4.1. From Global to Regional: The GUMBO and RUMBA Models

The Global Unified Metamodel of the BiOsphere (GUMBO) simulates the integrated earth systems and assesses the dynamics and values of ecosystem services (Boumans et al., 2002). GUMBO is a metamodel in that it incorporates the simplified version of several existing models at an intermediate level of complexity. The model simulates the dynamics of carbon, nutrients and water within the Atmosphere, Lithosphere, Hydrosphere, and Biosphere sectors, as well as the fluxes among these compartments, and across eleven biomes covering the surface of the planet. The dynamics of social interactions, the human economy and welfare are modeled within the Anthroposphere sector of the model.

GUMBO is the first global model to explicitly account for ecosystem goods and services and factor them directly into the process of global economic production and human welfare development (Boumans et al., 2002). In GUMBO, the flow of ecosystem goods and services are explicitly combined with manufactured and human capital to produce human welfare. Such design is based on the concept that natural capital is essential for the creation and maintenance of the human, physical and social capital aspects of the anthroposphere—commonly referred as the strong sustainability concept.

Appendix B provides detailed documentation on the major sectors of GUMBO model and the important processes within the sectors, as well as the connections among these sectors. Development of a baseline scenario and of four other scenarios based on different assumptions and policies, as well as their results, are also described in detail.

The construction of the GUMBO model is the result of a cooperative effort of scientists and of their attempt to integrate social, economic and ecological aspects of the Earth system using STELLA Programming Language (High Performance System 1993). Although I contributed to many discussions on several aspects of model building, and that of land cover change in more detail, my main contribution to GUMBO was the documentation of the model, particularly of processes and patterns within the sphere components of the model. I also contributed to the description of the scenarios and of the overall results of the model.

The model I developed for this research, the Regional Unified Model of the Amazon (RUMBA), is derived from the main GUMBO structure. However, unlike the global GUMBO model, considered a closed system with respect to the matter that is produced and exchanged within the spheres, RUMBA, a regional model, is by definition an open system. It accounts for inputs of matter from outside the region, as well as outputs to areas outside the region. Therefore, appropriate modifications were made to describe and simulate these inflows and outflows, and to transform the original global closed system model into a regional open-system model. Many other modifications were also made in order to account for forest specific processes that were not simulated within GUMBO. For instance, unlike GUMBO, RUMBA differentiates among land cover and land use, and has a more complex array structure to describe the patterns associated with change from forest or savanna, the two main original types of vegetation in the Brazilian Amazon region, to other land uses. These and other modifications are described in detail in the documentation of the many RUMBA spheres that follows.

RUMBA, like GUMBO, simulates energy, water, carbon, nutrients and mineral matter and their exchange between the five spheres: Atmosphere, Lithosphere, Hydrosphere, Biosphere and Anthroposphere (Boumans et al.2002). The Terrestrial systems stocks and processes occur on the soil (lithosphere), water (hydrosphere) and ground (biosphere) of four different land covers: forest, savanna, rivers and seasonally flooded forest. Forest and savanna land covers are changed into four different uses: agriculture, pasture, fallow and urban uses. Processes of production and exchanges between the atmosphere and terrestrial systems, as well as between the terrestrial systems and its different land covers, regulate the stocks within all spheres.

In the model, the atmospheric processes attenuate solar radiation energy that is used in the vital process of photosynthesis, where carbon dioxide is assimilated into energy-rich carbon compounds. The atmospheric exchange of carbon and nitrogen with terrestrial and aquatic systems (atmosphere sector) is regulated by growth, decay, burning, sedimentation as well as anthropogenic processes. Producers, consumers and decomposers control such processes on the ground (biosphere) and have an important role on the biogeochemistry and physical processes on the soil (lithosphere) and water (hydrosphere) of the different land cover/land uses. These conditions and processes result in the provision of goods and services, which are referred in the model as natural capital. Human-driven land cover changes have an effect on the provision and availability of natural capital, which in turn, is an important determinant of human economy and social welfare (anthroposphere). The basic structure of RUMBA summarizing this information is given in Figure 4.1.

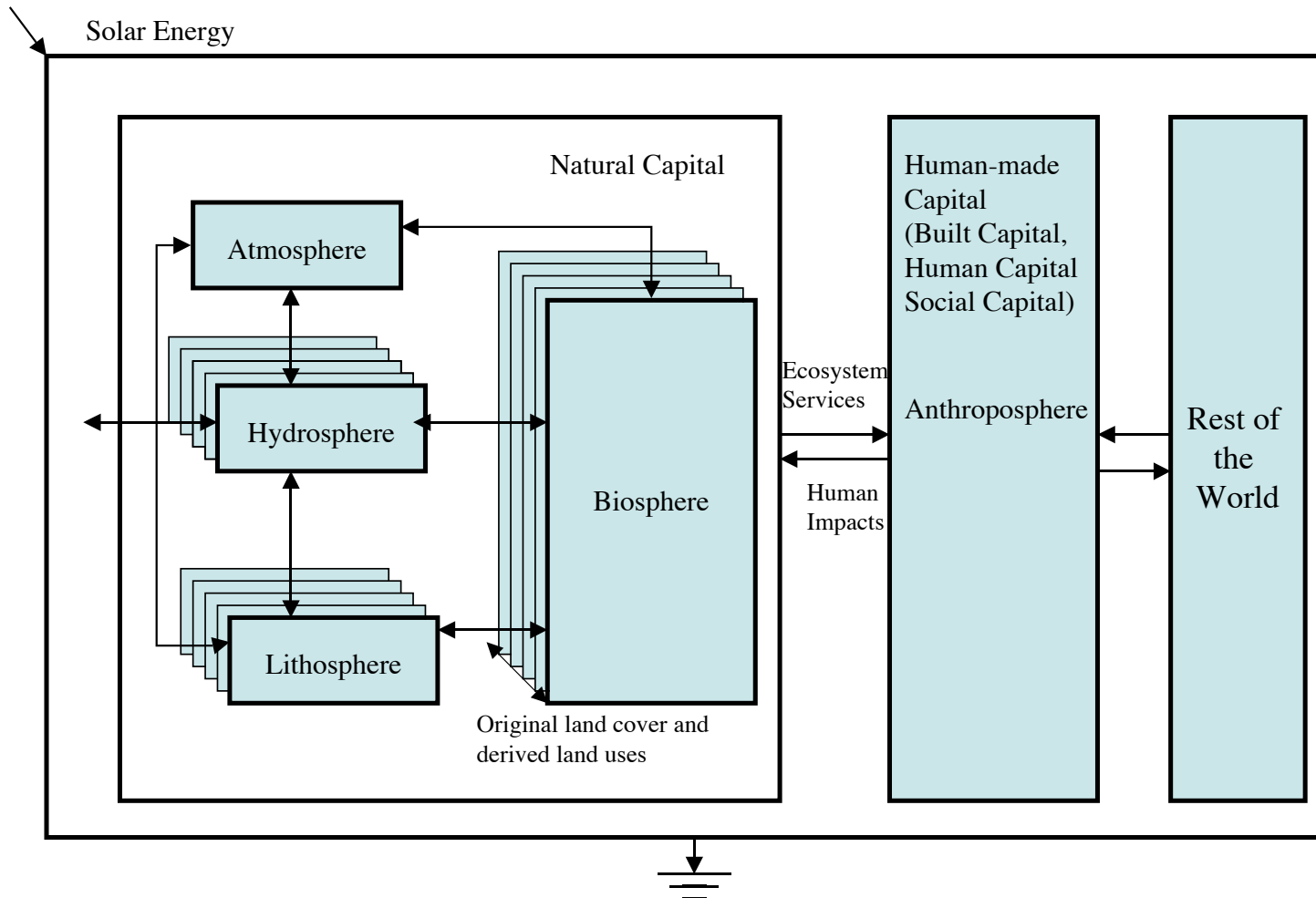

Figure 4.1. Basic Structure of RUMBA. The hydrosphere, lithosphere and biosphere are reproduced for the original land covers (i.e. forest and savanna), for the forest and savanna-derived land uses such as agriculture, pasture, fallow and urban uses, as well as for the land covers of rivers and flooded forest and lakes (adapted from Boumans et al., 2002).

RUMBA simulates the ecological, economic and social responses of the Brazilian Amazon region and its inhabitants to changes, with a main focus on the effects of this region's natural capital on human economy and welfare. It does so by means of production and welfare functions that not only account for the role of natural capital, but also define such capital as a limiting factor for the creation and maintenance of human, physical and social capital. Detailed explanation of processes occurring within each sphere of the model, together with the changes in the original model to account for the regional characteristics of the Brazilian Amazon, is provided below. Equations for important processes are also provided below and unless otherwise noted, parameters are specific for the each of land cover/uses simulated in the model.

4.2. Land Cover/Land Use Sector of RUMBA

In a strict sense, land cover refers to the type of feature found on the surface of earth, such as forests, rivers, crops, etc. Land use, on the other hand, refers to the human or economic use associated to land (crops, pasture, forestry, etc) (Lillesand and Kiefer 1994). In the original GUMBO model the concept of land use and cover are used interchangeably to refer to the biomes occurring on Earth. The biomes are represented by the global areas of vegetation (i.e. tropical forests) or cultivated land (i.e. croplands), with no reference to the original vegetation cover of human-altered land. In RUMBA, an explicit distinction is made between original vegetation (LC) and current land use (LU) to convey the dynamics of land use change and its effects on the Amazon forest. The land cover concept is used in a narrow sense to refer to the original vegetations/ecosystems of the region. According to this interpretation, the Amazon natural cover, e.g. forest (AMF), savanna (SAV), flooded forests/lakes (FFL), and rivers

(RIV), are either in their pristine (NE) state or altered by human use (CR, PA, FA, UR). The land uses derived from these original vegetations are defined as cropland (CR), pasture (PA), fallow (FA) and urban (UR) areas. In this sense, the sector land cover/land use of the RUMBA accounts for the initial changes occurring in the forest and savanna, the two main original land covers in the Amazon and the ones most subject to anthropogenic uses. It also accounts for the remaining pristine areas of both forest and savanna. The land cover and its uses are displayed in the model as an array structure that enables the simulation of the dynamics of land change for the entire area. This structure accounts for the subsequent changes over time among different uses within the forest or savanna land covers, explicitly maintaining the association among use at any point in time and its original vegetation cover/ecosystem.

While defining the land covers/uses to be modeled, many different land covers and land uses found in the Brazilian Amazon were aggregated according to their main similarities, under the limited land classes of cover/uses chosen to be modeled. The limitations of modeling the changes of use associated with forest and savanna only are apparent. However, this limited scope is largely dictated by the very limited information available on the remaining original covers. Next, an explanation of the main definitions, and methods of aggregation are presented based on a literature review.

4.2.1 Land Cover

Forest and savanna represent the main original vegetation types found in the Brazilian Legal Amazon. These vegetations are further defined as dense upland forest, open upland forests, alluvial floodplain vegetation (*varzea*) and savanna-type vegetation (Serrão and Homma, 1993). In RUMBA these vegetations were aggregated into land

covers defined as forests, flooded forest and savannas. In the model, forest cover (AMF) encompasses the dense and open forest found in the upland dystrophic and eutrophic soils. The seasonally inundated forest and lakes found on floodable eutrophic soils are represented as flooded forests (FFL). The savanna land cover (SAV) refers to the areas covered with dry, scrub vegetation, as well as to the native grassland of the dystrophic and eutrophic soils, found in the the central Brazilian Plateau and in patches within the Amazon rainforest region (Harris, 1980; Eiten, 1982; Sarmiento, 1983; Solbrig, 1996). Rivers (RIV) are the surface water running cover represented by the Amazon River mainstem and its tributaries. The two-dimension array structure of RUMBO (i.e. Land Cover by Land Use) allows change from forest (Land Cover) into cropland (CR), pasture (PA), fallow (FA) and urban land uses (UR) (Land Uses), keeping track on the remaining areas of forest, referred to in the model as natural ecosystems land use (NE). An independent but similar process models dynamics of land changes occurring in savanna cover.

4.2.2. Land Use

The last few decades of government-induced development of the Brazilian Legal Amazon have changed the landscape from its original cover into extensive areas of cropland and cattle ranching, as well as of settlement. The economic activities and population of the Brazilian Legal Amazon are more concentrated into the southern and eastern fringes of the region (Andersen, 1996), in areas of frontier expansion where resources are accessible by roads and close to markets (Nepstad et al., 1997).

Land use is mostly associated with the removal of forest or savannah for implementation of cropland and pasture activities. Shifting agriculture, an activity that is

more prominent in the formerly forested areas, has been practiced in the Amazon for thousands of years (Schmink, 1987) and there are more than five million people that depend on subsistence agriculture for livelihood in the Brazilian Amazon (Toniolo and Uhl, 1995). Pioneer agriculture is generally based on annual crops planted for one or two years, after which the land is converted into pasture or abandoned as fallow (Fearnside, 1988). Large-scale, commercial agriculture is also practiced in the Brazilian Amazon, most notably in the savanna (cerrado) areas at the southern portions of the Brazilian Amazon. In this region, large areas are devoted to the main commercial crops, soybeans, corn rice, coffee beans and manioc, comprising an important percentage of the national production (Nepstad et al., 1997).

Pasture, the main use of the cleared forest (Hecht, 1983; Fearnside, 1988; Margulis, 2003), and also a significant use of the savannah areas, is mostly associated with large-scale operations, although an increasing number of small farmers are practicing this activity as well (Andersen et al, 2002). As pasture land becomes unproductive within an average of ten years, the used area is abandoned and new areas are cleared. Decline in soil fertility, competition from invading weedy species and overgrazing are some of the main factors leading to pasture abandonment. Abandoned pastures generally fall into succession and are re-used again, although some are badly degraded or abandoned (Mattos and Uhl, 1994).

Forest regrowth (secondary forest) occurs in land that was originally covered with “primary” forest cover removed for cropland and pasture, or by logging activities (Perz and Skole, 2003) and eventually abandoned due to decreased productivity. In the Brazilian Amazon, the typical landscape of a previously deforested area is likely to

consist of patches of successional forests and cultivated lands (Lu et al., 2003). These successional forests play a crucial role in soil restoration through the accumulation of biomass, build up of litter and organic matter and other important soil-plant interactions (ibid). Furthermore, they are important in sequestering carbon from the atmosphere, in providing habitat and enhancing biodiversity, in restoring riparian zones, hydrological and biogeochemical cycles, as well as in providing important resources for humans (Lu et al., 2003; Salimon and Brown, 2000).

According to Uhl et al. (1982) the intensity of the deforestation process is an important determinant of the recovery capacity of the forest. For instance, although cut and burned forest sites previously used for pasture can generally recover into forest once abandoned, biomass accumulation and species richness on such sites tend to be smaller than that of a cut but not burned site (Uhl et al, 1988). And while it is estimated that approximately 100 years will be required for both a cut, and cut and burned Amazon caatinga forest to reach the mature level of the original forest cover, it will take more than a 1000 years for a bulldozed site of the same forest to recover to its mature level (ibid). However, the typical pattern of land use in the Amazon most certainly precludes full recovery as cleared land tends to oscillate between use and deuse, with abandonment and subsequent regrowth being allowed for a period long enough to recover the site's nutrient storage.

A study by Fearnside (1996) has shown that the average age of an abandoned site is about 6.7 years before it returns to either agriculture or pasture. It is interesting to point out that Salimon and Brown (2000) showed that in order for current annual losses of carbon from deforestation of the Amazon to be offset by the sink ability of the forest in

regrowth, a very large area would have to be abandoned each year and left to accumulate carbon for 30 years. However, because re-use of the fertile fallow areas is a common trend-- since it represents a much cheaper alternative when compared to the costly regain of fertility by means of external inputs (e.g. fertilizers) (Scatena et al., 1996), it is unlikely that forest would be let to regrow for such a long period of time.

In the RUMBA, cropland use refers to the areas of annual and permanent cropland found in the forested areas of the Amazon (AMF, CR), as well as those in the fertile soils of savannah region (SAV, CR). Pasture refers to the planted pasture devoted to cattle ranching in the forested areas (AMF, PA) and savanna region (SAV, PA). Fallow land uses (AMF, FA and SAV, FA) are the fallow, as well as the productive but not used, areas previously used (or to be eventually used) for agriculture or pasture purposes, derived from the forest and savanna original cover. In the forested areas, the fallows represent the secondary forest of abandoned areas of crop and pasture. Nuclei of settlement areas that provide urban functions for its population are considered urban land (AMF, UR and SAV, UR).

Figure 4.2. provides an overview of the LandCover/LandUse Sector of RUMBA. The process of land use change starts with clearing of forest or savannas for economic uses. Factors leading to deforestation were already described in section 3.5.1, in the analysis of Amazon model classified as “Deforestations and its Drivers”. In that section, I discuss the results of models addressing drivers of deforestation according to a framework proposed by Kainowitz and Angelsen (1998), concluding that both underlying causes and immediate causes of deforestation combine to drive deforestation in the

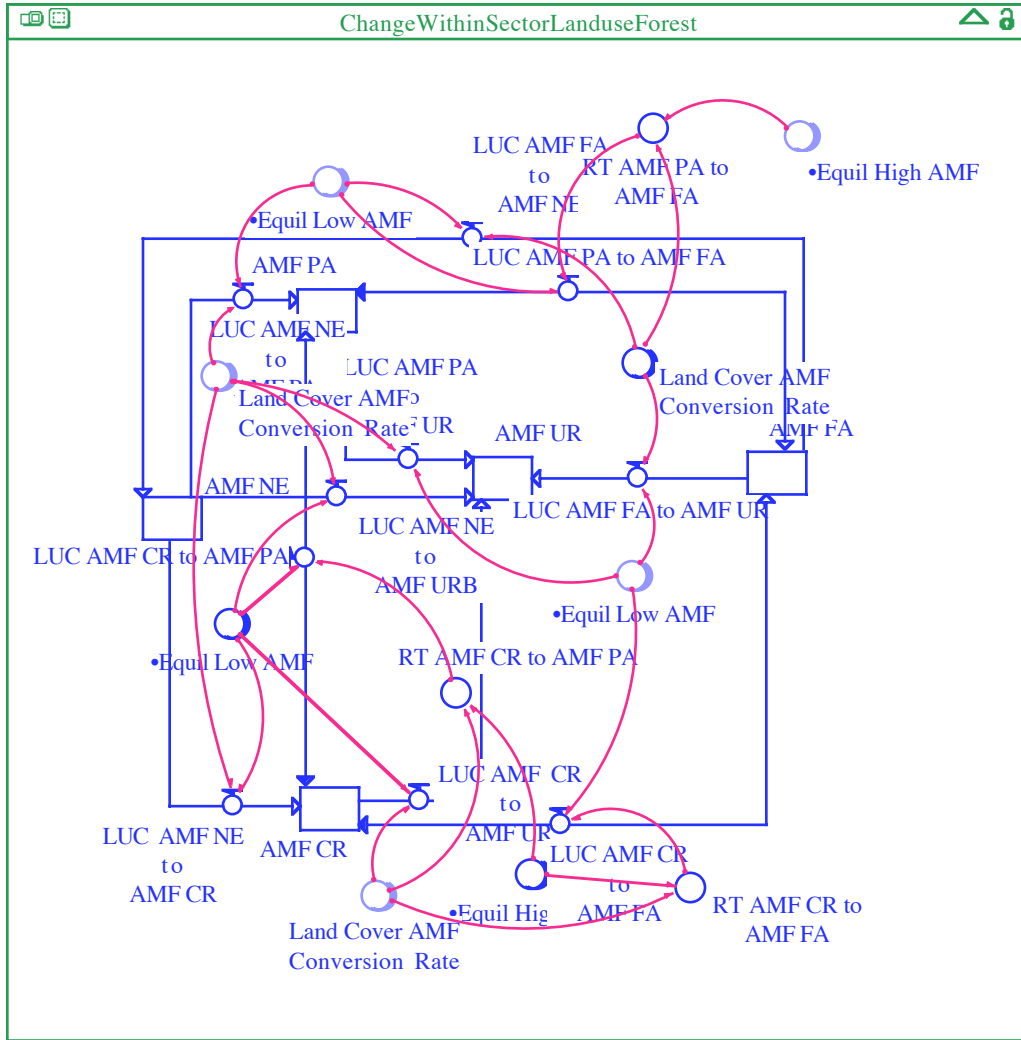

Figure 4.2a. STELLA Diagram of the Land Cover/Land Use of Forest Area.

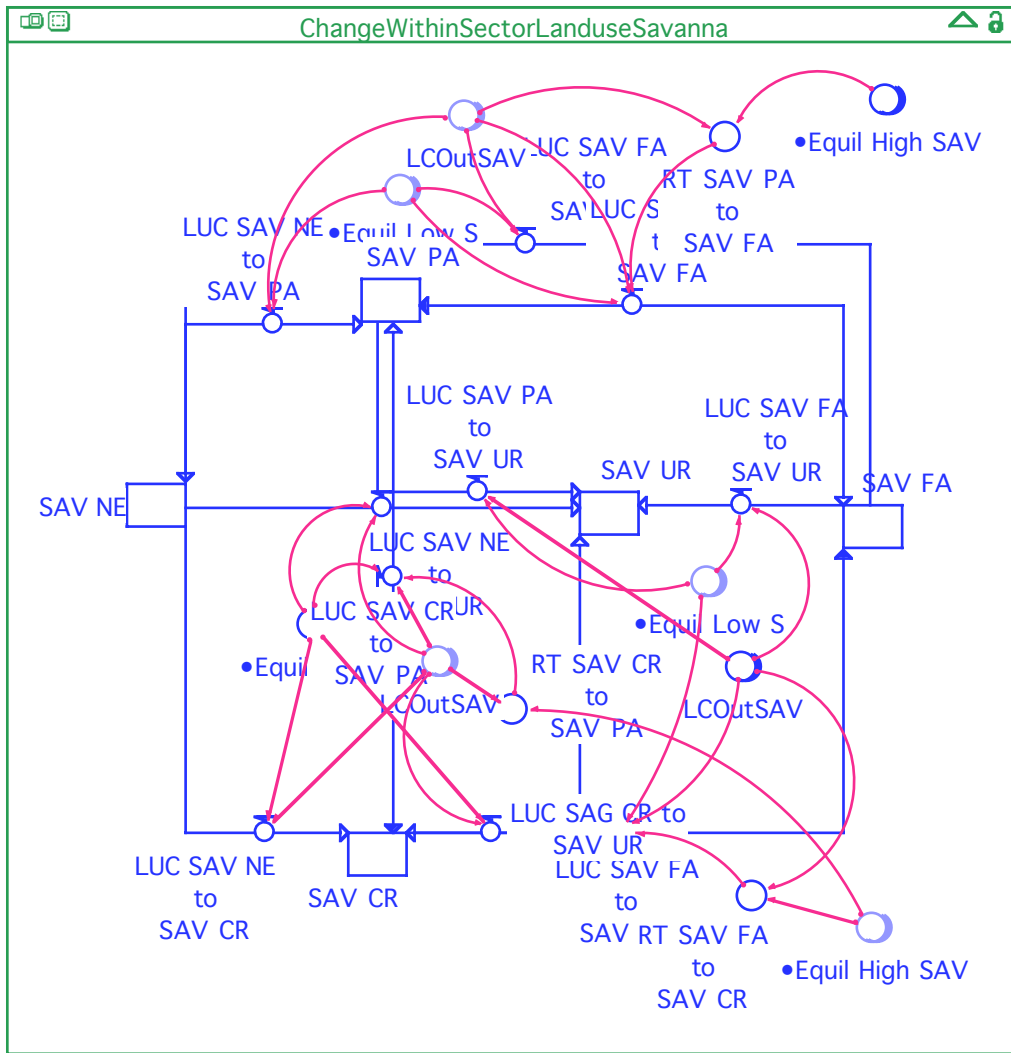

Figure 4.2b. STELLA Diagram of the Land Cover/Land Use of Savanna Area.

In RUMBA although I followed the main premise of GUMBO that processes of land cover/land use change are driven by demographic trends, many changes were made to closely account for what has been described in the literature as important factors of deforestation in the Brazilian Amazon. For instance, migration is an important factor leading to the initial forest clearance and to the patterns of land use over time. In RUMBA, population growth, urban population in particular, determines demand for local products. Inherent regional population plus the migration into the region are driven by factors such as accessibility to market, roads density, per capita income of the region, and increasing agricultural prices (Fearnside, 1987a; Fearnside, 1987b; Mahar and Schneider, 1994; Anderson and Reis, 1997; Cattaneo, 2001). Volume of exports and imports are used as a proxy for market accessibility (Gomes and Vergolino, 1997) and together with built capital represent an important factor in the decisions to clear land. The effects of the gross regional product on income and on agricultural prices determine the regional per capita income and agricultural prices, respectively.

In RUMBA, like in GUMBO, the factors described above determine rural and urban population, which in turn are combined to land use change conversion rates to determine bio-conversion rates (Land Cover Conversion Rate). Bio-conversion rates define the changes of one land use to another (Land Use Change Conversion Rate), following an algorithm that determines the conversion over time based on the maximum allowable area of a land cover/use (equilibrium high), as well as on its area at a certain point in time. This algorithm assumes that as more and more land is converted into another use it becomes more and more difficult to further convert the remaining area of that land use/cover into another use. It furthermore mathematically prevents conversion

of a land cover that has been entirely converted to a certain use. Equation 4.1 (LCCR: Land Cover Conversion Rate) describes the bio-conversion rate from land cover in its original state (NE) into other uses (LU)⁴.

$$LCCR = (\bullet LUC F Rural Effect_{[NE, LU]} * Rural Population + \bullet LUC F Urban Effect_{[NE, LU]} * Urban Population + \bullet LC F Conversion_{[NE, LU]} * GRP Growth) \quad [4.1]$$

where

•LUC F Rural Effect_[NE, LU] = Rate of Land Use Change Original Cover Rural Effect

Rural Population = Rural population

•LUC F Urban Effect_[NE, LU] = Rate of Land Use Change Original Cover Urban Effect

Urban Population = Urban population

•LC F Conversion_[NE, LU] = Rate of Land Cover Original Cover Conversion

GRP Growth = Rate of Gross Regional Product growth

Two types of changes are allowed among two stocks of land cover/land use. The first type of change is based on the assumption that a certain land cover/land use converted into another use will no longer return to its previous state. For instance, original vegetation (NE) can be converted into pasture (PA), but pasture not be converted back into original vegetation. This is mostly the case of original cover areas that once cleared are not assumed to return into its original use, rather going into fallow, from which they can return to an original use. It is also the case of land turning into urban areas, which are assumed to be a permanent use. Equation 4.2 (LUC_[NE to PA], the flux of land use conversion from original vegetation into pasture (k² yr⁻¹)) has as a unidirectional direction.

$$LUC_{[NE to PA]} = LCCR_{[NE, PA]} * LCO_{[NE]} * (1 - (\bullet Equil Low_{[NE]} / LCO_{[NE]})) \quad [4.2]$$

where

LCCR_[NE, PA] = Land Cove Conversion Rate, the rate of land conversion of original vegetation into pasture

LCO_[NE] = Remaining area of original vegetation

⁴ In this section I use the notation [NE, LU] to explicitly demonstrate the way that the algorithm of land cover/use is used to simulate the changes of vegetation in its original state (NE) to other human uses (LU).

•Equil $Low_{[NE]}$ = Minimum area of original vegetation

In contrast, the second type of change is based on the premise that a certain land use converted into another use can return back to its previous state (e.g. cropland in an area of previously original vegetation (NE, CR) can convert to fallow (NE, FA) and then back to cropland (NE, CR) and vice-versa, thus having a biflow direction).

The choice of the type of conversion is determined as the model is built based on empirical evidence of the likely change. The first type of change is simply based on an algorithm for population, built capital, bioconversion rate and the remaining area of the land being converted. The second type of change, based on a similar algorithm, allows for the definition of the likely direction of the flow between two stocks of land use, according to the result of the differential change from one use to another. The signal of the positive direction of the flow is established as the model is built, and considers the likelihood of change based on empirical evidence. The algorithm for that change, besides considering the parameters above, also considers the defined minimum allowable extension of a land cover/use (equilibrium low) and the overall extent at a certain point in time of both land cover/uses. The assumption in this equation is that as land moves closer and closer to its equilibrium low, conversion becomes more and more unlikely, until it is no longer possible because nothing remains in the stock to change further. Equation 4.3 (flux of conversion of land between cropland and pasture ($k^2 \text{ yr}^{-1}$)) describes a two-way flow of use among agriculture and pasture derived from an original vegetation cover. The convection establishes that more agriculture area is prone to become pasture than the other way around.

[4.3]

$$LUC_{[NE,CR-NE,PA]} = (MAXIMIZE(0, LCOut_{[NE,CR]} * RT_{[NE,CR to NE,PA]} * (1(Equil Low_{[NE,CR]} / LCOut_{[NE,CR]}))) + MINIMIZE(0, LCOut_{[NE,PA]} * RT_{[NE,CR to NE,PA]} * (1-(Equil Low_{[NE,PA]} / LCOut_{[NE,PA]})))$$

where:

LCOut_[NE,CR] = Area of agriculture in formerly original vegetation covered area

RT_[NE,CR to NE,PA] = Rate of conversion from agriculture into pasture area

•Equil Low F_[NE,CR] = Minimum area of agriculture

LCOutF_[NE,PA] = Area of pasture in formerly original vegetation covered area

Equil Low F_[NE,PA] = Minimum area of pasture

In summary, the bioconversion rates are designed in such a way as to allow land uses to change over time, and, in some cases, to return to their original cover. Forest covered areas, for example, may change into agriculture, pasture and urban areas (Equation 4.4, net change of forest vegetation (km² yr⁻¹)). Similarly, savannah areas, turn into agriculture, pasture and urban areas. Agriculture areas may turn into pasture, urban and fallow uses. Pasture may change into agriculture, urban and fallow as well (Equation 4.5, net change of pasture vegetation (km² yr⁻¹)). Fallow land use results from abandonment of agriculture and pasture areas. These re-growth forests or savannas might also turn into agriculture and pasture (oscillate between use and desuse), become urban areas, and possibly re-grow to mature forest or savanna.

[4.4]

$$d(NE)/dt = LUC_{[FA to NE]} - LUC_{[NE to URB]} - LUC_{[NE to PA]} - LUC_{[NE to AG]}$$

where

LUC_[FA to NE] = Inflow of land from fallow to original vegetation

LUC_[NE to URB] = Outflow of land from original vegetation to urban

LUC_[NE to PA] = Outflow of land from original vegetation to pasture

LUC_[NE to CR] = Outflow of land from original vegetation to agriculture

[4.5]

$$d(PA)/dt = LUC_{[NE to PA]} + LUC_{[CR to PA]} - LUC_{[PA to UR]} - LUC_{[PA to FA]}$$

where

LUC_[NE to PA] = Inflow of land from original vegetation to pasture

LUC_[CR to PA] = Inflow of land from agriculture to pasture

LUC_[PA to UR] = Outflow of land from original vegetation to pasture

LUC_[PA to FA] = Outflow of land from original vegetation to fallow

The model assumes no further changes occurring to land turned into urban areas, which are considered a permanent use of land. No changes are also modeled to the seasonally inundated areas and lakes of lowland forests (FLF, NE) and to water-running on rivers and stream (RIV, NE) either. Lack of detailed information on the extent of the overall use of such areas justify the choice to not simulate such changes, although it is important to point out that in the flooded areas shifting agriculture is an important source of subsistence for those living in this region (Fearnside, 1988).

4.3. Biosphere Sector of RUMBA

The biosphere module of RUMBA, like that of GUMBO, accounts for the ecosystem “production”, “consumption” and “decomposition”, the three major functions of the biotic communities of ecosystems. Primary production occurs as a result of photosynthesis, the fixation of light energy that results in the transference of carbon from its oxidized form in the atmosphere, to the organic forms that result in plant growth (Schlesinger, 1997). Chlorophyll-bearing plants and photosynthetic bacteria, generally referred as “producers” or “autotrophs”, perform primary production, generating energy to meet not only their metabolic needs and growth requirements (Kormondy, 1984), but also the needs of all other forms of life on Earth (Schlesinger, 1997). The heterotrophs, or “other- nourishing organisms”, depend entirely on the photosynthesis of green plants to obtain energy. Heterotrophs are further divided into “consumers” and “decomposers”. Consumers’ energy is obtained by feeding on organic compounds.

Primary production, generally measured as gross primary production and net primary production, is the annual amount of biomass produced and accumulated in the vegetation of ecosystems. Gross primary production (GPP) is the total organic matter

produced per unit of time (Longmann and Jenik, 1987), or the total rate of photosynthesis in an ecosystem. Net primary production (NPP), in turn, is the rate of accumulation of organic matter in plant tissues (Schlesinger, 1997), or the total photosynthetic gain (gross primary production minus respiratory losses) (Long et al, 1989; Dickinson and Murphy, 1998; Chambers, 2000). NPP represents the energy available to heterotrophs and has important impacts on soils, water fluxes, nutrient cycles, and climate (Raich et al., 1991). Decomposers' energy is obtained by the break down of complex organic materials into smaller molecules, which results in release of carbon dioxide, water, nutrients and humus. Figure 4.3. shows the Stella Diagram of this sector.

4.3.1. Biomass

Biomass, the dry mass of living organisms as well as the dead organic matter of an area, is estimated in the model as the dry matter of vegetation ($T \text{ km}^{-2}$), mass of organisms, and dead organic matter in a land cover/land use. Generally speaking, five major pools compose the total storage of biomass in a forest: 1) the above and below ground living parts of trees and vegetation; 2) the wood debris, composed of the dead fallen tree stems and 3) the forest floor, composed of litterfall accumulated on forest soil surface; 4) the organic soil, resulted from decomposition of organic matter by microorganisms; and 5) the tissue of heterotrophic organisms (decomposers and consumers) (Barnes et al., 1998). In the RUMBA Biosphere, biomass was aggregated as: 1) above and below ground biomass of forest vegetation, simply referred as “autotrophs”; 2) the wood debris and litterfall accumulated in forest floor, referred as the storage of “dead organic matter”; and 3) living weight of consumers and 4) decomposers, simply

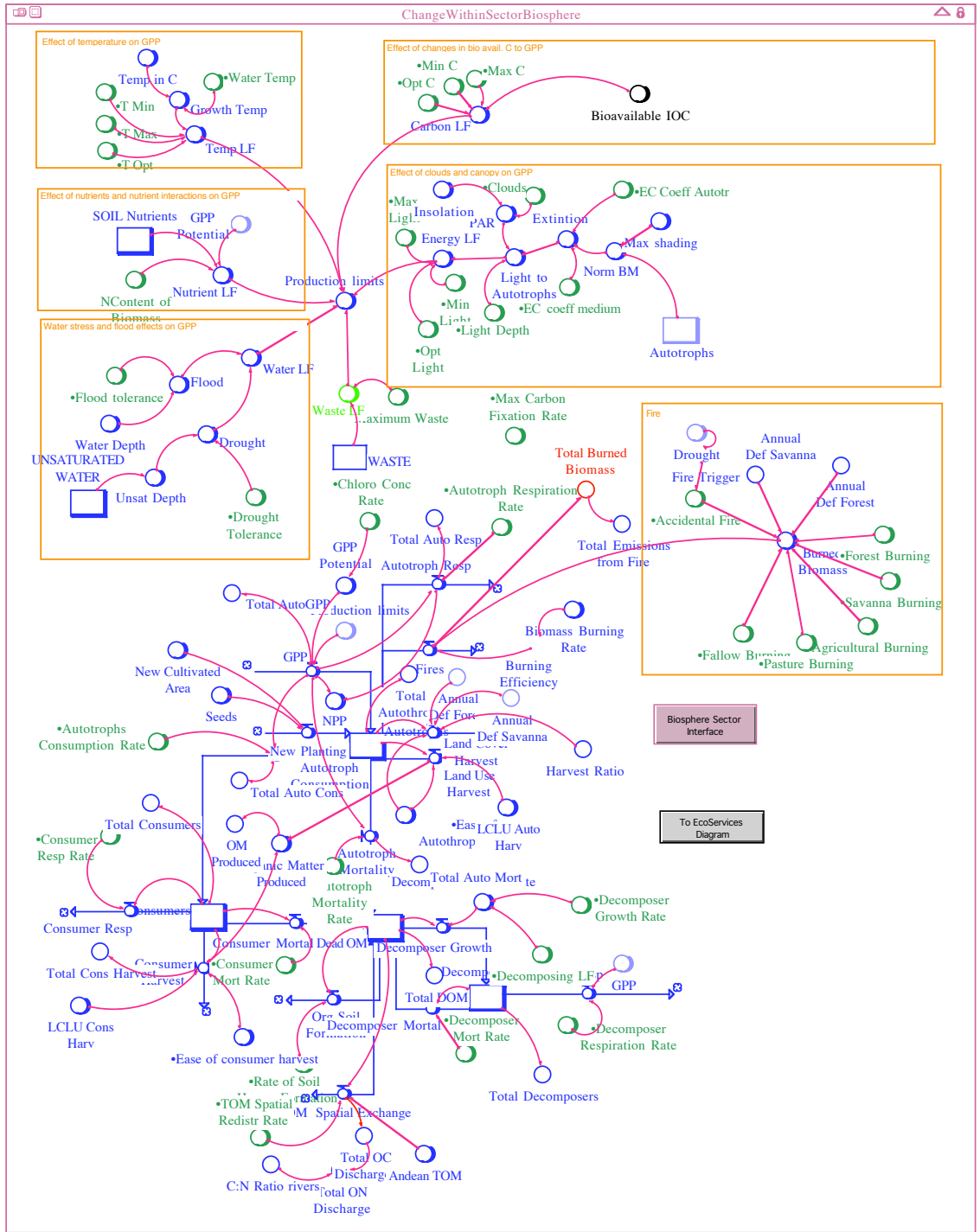

Figure 4.3. STELLA Diagram of the Biosphere Sector of RUMBA.

referred as consumers and decomposers, respectively. The storage of organic matter in the soil (soil C) is modeled in the lithosphere sector of RUMBA.

Much uncertainty exists in relation to biomass of tropical forests (Clark and Clark, 2002) and that of the Amazon in particular (Houghton et al., 2000). However, it is now known that the Amazon – the largest area of contiguous tropical forest and nearly one-half of the world’s undisturbed forest – accounts for approximately 10 per cent of the terrestrial primary productivity (Tian et al., 1998). Furthermore, the Amazon is home to the richest biota on Earth (Erwin, 1988) with tens of thousands of species, many of which are yet to be discovered (Plotkin, 1988). Not surprisingly, the great diversity of tree species and the resulting high heterogeneity, both among different types of vegetations as well as within the same vegetation, represent one of the main impediments to estimating an average biomass value for the Amazon (Bernoux et al., 2001).

Many different biomass estimations (Brown and Lugo, 1982; Brown and Lugo, 1984; Brown et al., 1989; Brown and Lugo, 1992; Fearnside, 1992; Fearnside, 1993b; Fearnside, 1997c) provide diverging values, depending on whether direct, indirect, direct/indirect and indirect/direct estimates are used, as well as whether extrapolations are done based on different vegetation-classification methods (Bernoux et al., 2001). Despite the challenges associated with it, getting reliable estimations of the biomass of tropical forests, and of the Brazilian Amazon in particular, is vital given the important role that the carbon stored in the biomass of these forests plays in the global carbon cycle (Houghton et al., 1983c; Salomão et al, 1996; Fearnside, 1997b; LBA, 1999; Nascimento and Laurance, 2002). Indeed, Houghton et al (1983a; 1983b) shows compelling evidence

of the increasing releases of CO₂ to the atmosphere over 1850-1985, as the forest in Latin America is replaced by pasture, cropland, degraded lands and shifting cultivation.

The biomass values used to define the initial conditions of autotroph biomass in the RUMBA are summarized in Table 4.1. as above ground biomass, below ground biomass and litterfall. Estimates of above and below-ground biomass of all Amazon forest types (i.e dense and non-dense forest) based on a regional scale survey ranged from 27,200 to 46,400 T km⁻² (Fearnside, 1992; Fearnside, 1997b; Bernoux et al., 2001). The latter value, also the most recent one, was chosen since it represents a better assessment of the overall biomass. Little information is available on savannas in Latin America (Lamotte and Bourlière, 1983) and in Brazil in particular. A study by Bernoux et al., (2001) showed savanna biomass for all savanna types ranging from 11,700 to 60,200 T km⁻², with the mean area biomass of 28,400 T km⁻². This study estimated other non-forest vegetation mean biomass values as 62,400 T km⁻². Because the model aggregates all non-forest types into “savanna”, I chose to use the mean biomass of the combined savanna and other non-forest types, or 33,100 T km⁻², as the savanna biomass value (ibid). Much less information is available for the biomass of vegetations under human uses of land. Extrapolations of biomass for such human-used areas were estimated based on Schroeder and Winjun’s (1995a) interpretations of values provided by Olson et al. (1983).

The model uses the autotrophs biomass values as a reference, after which consumers and decomposers are estimated, based on rates that define their percentage in relation to the vegetation biomass. As discussed later, this approach was chosen because of the scant or no reliable information on the biomass values of consumers (Owen, 1983) or decomposers (which is in stark contrast to the extensive information available on

Table 4.1. Biomass Values of Land Cover/Land Uses of the Brazilian Amazon Used in the Biosphere Sector (T km⁻²)

Land Cover/Land Use	Above and Belowground Biomass	Aboveground Biomass	Belowground biomass	Litter
Forest/Natural ecosystem	43,400 ^a	32,600 ^b	10,900 ^c	2,800 ^d
Cropland in forest	1,100	900	200	200
Pasture in forest	1,500	1,500	-	-
Fallow in forest	8,900	7,600	1,300	1,300
Flooded Forest	7,200	3,600	3,600	-
Rivers	600 ^e	-	-	-
Savanna/Natural ecosystem	6,700	2,600	4,100	400
Cropland in savanna	1,200	1,200	-	-
Pasture in savanna	1,200	1,200		

^aRange: 27,200 – 46,400 T/km². Chosen values based on Fearnside (1992,1997b);

^bRange: 22,700 – 32,000 T/km². Chosen values based on Brown and Lugo (1992) and Fearnside (1992);

^c Feanside (1997b);

^d Feanside (1997b);

^e Fitkau et al. (1975);

All other values calculated by author based on Schroeder and Winjun (1995a) and Olson et al. (1983).

vegetation biomass). In summary, the initial conditions of biomass are estimated based on initial conditions of land cover/land use, the autotrophs biomass and the rates of autotrophs, consumers and decomposers. This value is then transformed into its C equivalent (T/km²), which is approximately 45% of the dry weight of biomass.

4.3.2. Production Limits within Biosphere Sector

In the model, primary production is limited by “production limits” parameters that constrain the physiological processes of photosynthesis and the overall ecosystems growth. Temperature, carbon in the atmosphere, availability of nutrients, irradiance, water stress, and levels of waste are the limiting conditions to productivity that are simulated in RUMBA (Boumans et al., 2002). Production limits are simulated as individual indices for each of these conditions, based on extremes (maximum, minimum values), ideal (optimal values) and reported conditions in the region, determined for each of the land cover/land uses described in the model. An overall production limit is also calculated and used to limit GPP.

4.3.2.1. Temperature

Temperature and its changes have a direct impact on the rates of gross photosynthesis, and on the carbon gain of ecosystems (Barnes et al., 1998). In the Brazilian Amazon, like most tropical forests, constant high temperatures with daily variations that are greater than seasonal variations (Lavelle, 1987; Longman and Jenik, 1987; Lauer, 1989; Whitmore, 1996; Haridasan, 2001) favor high rates of photosynthetic production.

Similarly to GUMBO, the effect of temperature on vegetation growth is simulated in RUMBA based on an algorithm that accounts for temperature on land, as well as for maximum, minimum and optimum temperature conditions (Equation 4.6, limiting effect of temperature on primary production). Daily maximum and minimum temperatures measured by Uhl, C. and Kauffman, J. B. (1990) in four vegetation cover types in Paragominas, State of Pará, Brazil, were used in the model in simulating the effects of

temperature changes on growth. These values varied between 27.7 and 38.2°Celsius (maximum temperature), and 19.9 and 22° Celsius (minimum temperature). Optimum growth values for forest were estimated based on Longman and Jenik (1987) and their assertion that optimum values tend to lie nearer the maximum than the minimum end of the range. The savanna areas optimum temperature values were estimated based on Nix's (1983) mean values of 24° Celsius for South American savannas. The temperature on land cover/land uses derives from the temperature simulated in the Atmosphere Sector of RUMBA.

$$Temperature\ LF = IF\ Growth\ Temp > T\ Max\ OR\ Growth\ Temp < T\ Min\ THEN\ 0\ ELSE\ 1 - ABS((Growth\ Temp - T\ Opt)/(Growth\ Temp + T\ Opt)) \quad [4.6]$$

where
 Growth Temp = Growth temperature
 T Max = Maximum temperature
 T Min = Minimum temperature
 T Opt = Optimum temperature

4.3.2.2. Carbon

The amount of carbon available to be fixed through photosynthesis and the rate at which it returns to the atmosphere is also an important factor in limiting productivity (Barnes et al., 1998). In RUMBA, this effect is simulated according to Equation 4.7 (limiting effect of carbon on primary production). The Carbon limiting factor is based a bio-available carbon, the atmospheric carbon output from GUMBO (Boumans et al., 2002), as well as on minimum and maximum atmospheric carbon values, following a model provided by McKane et al. (1995).

[4.7]

*Carbon LF = IF Bioavailable IOC > Max C OR Bioavailable IOC < Min C THEN 0
ELSE ABS((Bioavailable IOC - Opt C)/•Opt C)*

where

Bioavailable IOC = Level of atmospheric C available for primary production

Max C = maximum amounts of atmospheric C necessary for primary production

Min C = minimum amounts of atmospheric C necessary for primary production

Opt C = optimum amounts of atmospheric C for primary production

4.3.2.3. Energy

Solar radiation provides the energy necessary to photosynthesis and has, as a result, an important effect on productivity. The short wave energy rich radiation reaching the surface – the visible radiation in the region between 400 and 700 nm – is the portion important for photosynthesis (Longman and Jenik, 1987). This energy, also called photosynthetic active radiation (PAR) is measured as the number of photons within the visible spectrum striking a surface (Barnes et al., 1998) and represents about 45% of the incident radiation. PAR enters the forest at the top, being attenuated/extinguished as it travels down the canopy (Whitmore, 1996).

The extinction coefficient expresses the rate of attenuation of light as it penetrates the canopy. In forest ecosystems, the extinction coefficient is largely a function of biotic conditions, and more specifically, of the leaves, which absorb/transmit most of the light striking the vertical layers of forest structure. As a result, light intensity tends to decrease as it travels down the canopy. Sunflecks – i.e. patches of direct sunlight, sunlight reflected from vegetation, diffuse skylight, and diffuse skylight filtered by vegetation – are an important source of light in the forest interior (Longman and Jenik, 1987), and the largest source of light reaching the forest floor. Sunflecks reaching the forest floor may be as low as 0.1 to 2%, and often times less than 1% of that above the canopy surface (Kira and Yoda, 1989; Whitmore, 1996; Longman and Jenik, 1987; Barnes et al.,

1998). The extinction coefficient, a function of, among other things, the time of the day, the season and latitude, is also strongly dependent on water vapor and particulates.

RUMBA models the energy available to producers, based on surface light, the extinction coefficient and light depth. Shading conditions determine the extinction coefficient for terrestrial systems, respectively, whereas cloud conditions and PAR determine the surface light. The Energy Limiting Factor (Equation 4.8), is a function of light available in relation to documented values of optimum, minimum and maximum solar radiation conditions.

[4.8]

$$\text{Energy LF} = \text{IF Light to Autotrophs} > \text{Max Light OR Light to Autotrophs} < \text{Min Light THEN } 0 \text{ ELSE } 1 - \text{ABS}((\text{Light to Autotrophs} - \text{Opt Light}) / (\text{Light to Autotrophs} + \text{Opt Light}))$$

where

Light to Autotrophs = Amounts of available light for primary production

Max Light = maximum amounts of light necessary for primary production

Min Light = minimum amounts of of light necessary necessary for primary production

Opt Light = optimum amounts of of light necessary necessary for primary production

4.3.2.4. Nutrients

Soil and biomass nutrients availability, like the other factors described, also has an important impact on photosynthesis and growth of an ecosystem. Nitrogen is a frequently limiting nutrient in terrestrial ecosystems. (Vitousek and Howarth, 1991; Pastor et al., 1984; Vitousek et al., 1997; Asner et al., 1997; Fenn et al., 1998). Its presence in photosynthetic processes makes it possible for plants to assimilate carbon and allocate it into plant foliage, stems, and roots of trees (Fan et al., 1998). Hence, in terrestrial systems, carbon uptake and storage in the soil are strongly regulated by the nitrogen cycle (Vitousek and Howarth, 1991; Asner et al., 1997).

In the RUMBA, this limiting factor is modeled as a ratio between the nutrients in the soil, as modeled in the lithosphere of the model, over the product of the estimated GPP potential and the nutrients in the biomass, also modeled in the lithosphere (Equation 4.9, limiting effect of nutrients on primary production).

[4.9]

$$\text{Nutrients LF} = \text{MINIMIZE}(1, \text{SOIL Nutrients}/(\text{GPP Potential} * \text{N Content of Biomass}))$$

where

SOIL Nutrients = Amounts of available nutrients in soil

GPP Potential = Potential Gross Primary Production

N Content of Biomass = Amounts of available nutrients in biomass of vegetation

4.3.2.5. Water

The importance of water stress in tropical forests should not be underestimated.

While rainfall is the main factor controlling the distribution of tropical forests, soil moisture and water availability are known to determine the local patterns of forest types (Longman and Jenik, 1987). Moist soils, for example, are characterized by single dominant species and by less endemism than well-drained upland forests. The Brazilian Amazon's periodic heavy rainy seasons, and the associated rise and fall of the rivers levels have given rise to permanently inundated forests, as well as to the seasonally inundated forests. Both compositions are aggregated in the model as flooded forests (FLF, NE). Dry, well-drained soils species in turn, are characterized by reduced height and drought-tolerant species. These refer, for example, to the areas covered with dry, scrub vegetation, as well as to the native grassland, referred in the model as savanna.

RUMBA models the water effects on plant growth and its limitation to photosynthesis on both moist and dry soil conditions, by estimating their overall propensity to flood and drought, respectively (Equation 4.10, limiting effect of water on

primary production). The stocks of water available as saturated and unsaturated water (modeled in the hydrosphere) and factors such as porosity, elevation, root depth, and parameters of flood and drought tolerance determine the system limitation to primary production as a result of water stress. In the model, flood is a function of water depth and the soil flood tolerance. Drought, in turn, is a function of the water available in the soil, as well as a parameter that defines its propensity to drought.

[4.10]

$$\text{Water LF} = \text{Drought} * \text{Flood}$$

where

Drought = Tolerance to drought

Flood = Tolerance to flood

4.3.3. Primary Production

RUMBA calculates gross primary production (GPP) as the gross primary production potential (GPP potential) adjusted by an index that limits the overall productivity (Production limits). GPP potential, defined as the maximum carbon fixation capacity of a land cover/land use, given its chlorophyll concentration, was estimated based on an empirical equation provided by Whittaker and Marks (1975) for NPP, modified to account for GPP instead (Equation 4.9, potential primary production of vegetation ($T \text{ km}^{-2}$)). Values of chlorophyll concentration for the different vegetation types simulated in the model are displayed on Table 4.2. Equation 4.11 estimates the overall GPP for the vegetation types described in the model ($T \text{ km}^{-2}$).

[4.11]

$$\text{GPP Potential} = 10^{(0.24 * \text{Chloro Conc Rate} + 2.19)} * 2$$

where

Chloro Conc Rate = Level of Chlorophyll concentration of vegetation

*GPP = IF AmazonLand = 0 THEN 0 ELSE AmazonLand * GPP Potential * Production limits*

where

AmazonLand = Areas of forest vegetation and its main uses

Net primary production (NPP), in turn, is measured as the rate of accumulation of organic carbon in the tissue of land autotrophs. In the model, NPP is calculated as the difference between GPP and the Autotrophs respiration. Net ecosystem production (NEP), in turn, is the net carbon accumulation by ecosystems, including all fluxes from an ecosystem such as autotrophic respiration, heterotrophic respiration, losses associated with disturbance, dissolved and particulate carbon losses, volatile organic compounds (VOCs) and spatial exchanges among ecosystems (Randerson et al., 2002). The biosphere sector of RUMBA simulates all those fluxes, with the exception of Volatile Organic Compounds (VOCs), which were not included for both simplification purposes and because not enough is known about such compounds (Tian et al, 1999). Autotrophs respiration is measured as plant metabolism (respiration), based on a rate of primary production. The stock of Autotrophs in the model is regulated by natural processes such as primary production, respiration, consumption and mortality, as well as by anthropogenic processes such as those associated with removal of vegetation and fire (Equation 4. 13, net change of autotrophs (T). The removal of biomass for anthropogenic use is simulated both as clearing of vegetation cover, as well as that the removal of biomass on areas of cropland, pasture, logging and fallow. These processes are defined by deforestation rates (simulated in the land cover/landuse sector of the model) and

harvest rates that are determined according to the demand for organic matter simulated on the anthroposphere sector.

[4.13]

$$d(\text{Autotrophs})/d(t) = (GPP + \text{New Planting} - \text{Autotroph Resp} - \text{Autotroph Mortality} - \text{Land Use Harvest} - \text{Autotroph Consumption} - \text{Fires} - \text{Land Cover Harvest})$$

where

GPP = Gross Primary Production

New Planting = Reforestation

Autotroph Resp = Autothoph respiration

Autotroph Mortality = Plant mortality

Land Use Harvest = Harvest of of biomass of cultivated vegetation (e.g. cropland)

Autotroph Consumption = Consumption of biomass by autotrophs

Fires = Biomass burning

Land Cover Harvest = Harvest of of forest biomass (e.g. logging)

Burning of biomass as anthropogenic-caused fires are simulated as “deforestation fires” (Forest Burning), “forest surface fires” (Accidental Fire), and “fire on deforested land” (i.e. Cropland/Pasture/Fallow Burning), following the classification provided by Nepstad et al. (1999a) as described in Chapter 2. In RUMBA the occurrence of these fires, grouped as “Burned Biomass” (Equation 4.14, burned biomass (T)), is dependent on a fire trigger – a function of the drought modeled on the Water LF sector of the biosphere – and is determined by burning efficiency of biomass (Seiler and Crutzen, 1980). The gross net flux of emissions from biomass burning is estimated from the total burning of biomass.

[4.14]

$$\text{Burned Biomass} = (\bullet\text{Forest Burning} * \text{Annual Def Forest} * \text{Below \& Above Biomass} * \bullet\text{Accidental Fire} + \bullet\text{Savanna Burning} * \text{Annual Def Savanna} * \text{Below \& Above Biomass} + \bullet\text{Agricultural Burning} * \text{AmazonLand} * \text{Below \& Above Biomass} + \bullet\text{Pasture Burning} * \text{AmazonLand} * \text{Below \& Above Biomass} + \bullet\text{Fallow Burning} * \text{AmazonLand} * \text{Below \& Above Biomass})$$

where

•Forest, •Savanna, •Cropland and •Fallow Burning = Burning of forest, savanna, cropland, pasture and fallow biomass, respectively

Annual Def Forest and Annual Def Savanna = Annual deforested area of forest and savanna, respectively
 Below & Above Biomass = Below and above ground biomass of vegetation
 •Accidental Fire = forest surface fires primarily the result of accidental fires

Table 4.2. Total Chlorophyll Content of Vegetation (g m⁻²) Used in the Biosphere Sector.

Land Cover/ Land Use	Range
Forest/Natural ecosystem	3 – 9
Cropland	1 – 5
Pasture	1.7-5
Forest Fallow	-
Savanna	-
Flooded forest	0.3 – 4.3
Rivers	0.005 – 1.3
Urban	-

All values based on Lieth (1975).

4.3.4. Consumption

Consumers biomass is modeled in the biosphere as factor of consumption of food (provided by autotrophes), losses on respiration, harvesting by man, and mortality rates (Equation 4.15, net change on consumers biomass (T)). Decomposer's biomass, in turn, is modeled in RUMBA as a result of their assimilation of a pool of dead organic matter that is formed as a result of autotrophes and consumers mortality, as well as that of other decomposers, and by their own respiration (Equation 4.16, net change on decomposers biomass (T)). There is scant information on the biomass, density and diversity of consumers and decomposers on tropical forests (Owen, 1983). An important observation is that animal biomass is extremely small when compared to plant biomass. Animal biomass in central Amazonia comprises only 0.02 percent of the total forest biomass (Fittkau and Klinge, 1973), whereas it is estimated to be about 0.1 percent of the total biomass in a montane tropical rainforest in Puerto Rico (Odum et al., 1970).

[4.15]

$$d(\text{Consumers})/d(t) = \text{Autotroph Consumption} - \text{Consumer Resp} - \text{Consumer Mortality} - \text{Consumer Harvest}$$

where

Autotroph Consumption = Consumption of autotroph biomass

Consumer Resp = Consumer respiration

[4.16]

$$d(\text{Decomposers})/d(t) = \text{Decomposer Growth} - \text{Decomposer Resp} - \text{Decomposer Mortality}$$

where

Decomposer Resp = Decomposer respiration

Furthermore, larger animals (i.e. mammalia, aves, reptilia and amphibia) represent less than 1/5 of the total animal biomass composition (Fittkau and Klinge, 1973). The remaining of the total animal biomass is composed mostly of soil fauna, large oligochaeta, araneida, isoptera, formicedae and other insects. Soil fauna biomass, composed mostly of ants and termites, may be as much as four times the herbivore biomass (ibid) and about 50 – 75 percent of the total animal biomass. Indeed, about half of the forest animal biomass feeds on litter. Carnivores are estimated to be 24 percent of animal biomass, whereas omnivorous are estimated as 2 percent of total biomass.

Not surprisingly, the majority of biomass is found where most of the food base of the total animal biomass is provided: litter and forest debris. Fittkay and Klinge (1973) studies on lowland Amazon rain forest estimate the herbivores and carnivore biomass as about 45 kg ha⁻¹, whereas soil fauna biomass as about 165 kg ha⁻¹. According to these estimates, consumers and decomposers biomass correspond to 0.01 and 0.04 percent of the vegetation biomass of an undisturbed forest, respectively. The model used these ratios to estimate the initial conditions of consumers and decomposers.

4.3.5. Decomposition

Mortality of autotrophs, consumers and decomposers accumulates as dead organic matter in soil or soil surface (Equation 4.17, net change on dead organic matter (T)).

Dead organic matter is broken down, further reduced and mineralized by decomposers to release proteins, carbohydrates, lipids and minerals that are absorbed by other organisms or carried out of the system (Golley, 1983).

$$d(\text{Dead OM})/d(t) = \text{Decomposer Mortality} + \text{Consumer Mortality} + \text{Autotroph Mortality} - \text{Decomposer Growth} - \text{Org Soil Formation} - \text{TOM Spatial Exchange} \quad [4.17]$$

where

TOM Spatial Exchange = net exchange of total organic matter (from within the system land cover/uses and outside sources)

The mechanisms of the decomposition involve the removal of soluble compounds by water (leaching), conversion of large particles to small particulates (litter comminution) and microbial catabolism (Wagener et al., 1998). Decomposers cycle the organic matter and nutrients provided by the dead biomass of organisms through their own matter, making it available to tree roots in the surface organic layers of the soils. Fungi, believed to be the primary decomposers in the forest, are extremely important in releasing energy that will become available for plant growth and play a vital role in the energy flow in the forest (Fittkay and Klinge, 1973). Mycorrhizal fungi, in particular, are believed to be of great importance in Amazon forest, providing a “direct cycling” of essential elements from decomposing matter to tree roots (Went and Stark, 1968; Stark, 1971a; 1971b; Klinge, 1973; Golley, 1983).

The “production”, “consumption” and “decomposition” processes of the biosphere sector essentially depicts the uptake of carbon from the atmosphere, its cycling

on terrestrial systems, and its return to the atmosphere. As put by Schlesinger (1997) “the overall storage of carbon on land is determined by the balance between primary production and decomposition, which returns carbon to the atmosphere as CO₂.”

Increasing deforestation, abandonment of agricultural land, logging and fire are certain to severely impair the provision of important forest functions and goods, and to cause disturbances that may prevent humans from knowledge of the existence of unknown, yet crucial species in forest processes.

4.4. The Lithosphere Sector of RUMBA

The lithosphere module of the RUMBA, similarly to that of GUMBO, models soils and sediments, with a focus on carbon and nutrients (Boumans et al., 2002). As a general rule, rock weathering, water movement, organic decomposition and varying climatic conditions influence the process of soil formation, its nutrient availability and carbon storage (Schlesinger, 1997). In the old and highly weathered soils of tropical forests, however, litterfall and roots turnover play a critical role in the nutrient cycling, returning organic matter and nutrients from vegetation to the soil (Luizao, 1989) and contributing to the flux of humus to the superficial layers of soil. For that reason, the storages of soil nutrients and organic matter in the model are highly dependent on the organic matter that is produced in the Biosphere module, and returned to soil. Soil losses, in turn, are simulated as the result of weathering, chemical and mechanical erosion. An overview of this sector is provided in Figure 4.4.

4.4.1. Soils Quality and Ecosystem Production

In tropical regions, constant high temperature and intense rainfall have over time contributed to the intense leaching and weathering of underlying rocks. This process has left Amazonian soils with highly weathered clay minerals with a relatively low ability to retain nutrients due to its low cation exchange capacity (CEC). As a result, Amazonian soils are, as a general rule, old, highly leached, poor in nutrient, low in pH and with high levels of aluminum toxicity (Pires, 1978; Jordan and Kline, 1972; Jordan et al, 1972; Jordan and Herrera, 1981; Jordan, 1982; Jordan, 1985; Lavelle, 1987, Stark and Jordan, 1978; Cuevas and Medina, 1986; Cuevas and Medina, 1988; Sanchez, 1989; Tiessen et al., 1994). This is the case of the most abundant soils in the Legal Amazon, the ferralitic soils: Oxisols and Ultisols (Jordan, 1985; Lavelle, 1987). Oxisols (latossolos), Ultisols and Alfisols (podzolicos) cover about 75 percent of the total area of the Legal Amazon (Cerri et al, 2000; Bernoux et al., 2001). According to Montgomery and Askew (1983), while oxisols are the most common drained soil of tropical forests, ultisols and alfisols are the most common drained soils of savannas. In the Brazilian Amazon, three dystrophic soil types (Podzolico Vermelho Amarelo, Latossolo Amarelo and Latossolo Vermelho Amarelo (orthic Ferralsol) cover 60% of the total area (ibid). The remaining classes of soils found in the Amazon can be ranked by their degree of fertility, from highly infertile soils (podzols), relatively fertile soils (entisols and inceptisols) and rather fertile soils (vertisols and mollisols) (National Research Council, 1982; Lavelle, 1987).

In spite of its characteristic poor soils, the Amazon is, on average, one of the most productive terrestrial systems in the world. The explanation is that the same environmental conditions that lead to leaching and weathering of soils, also support high

decomposition of an otherwise nutrient-rich biomass (Cuevas and Medina, 1986), favoring quick nutrient cycling and biomass growth. The key for such efficient mechanism seems to be what has been hypothesized by Went and Stark (1968) as “direct nutrient cycling”. According to this hypothesis, most of the nutrients released are not leached down to the mineral soil but instead transferred directly to the roots growing between layers of leaves, dead woody fruits, termites galleries and wood. Stark (1971a) research on the Central Amazon, showed a concentration of feeder roots in the upper 10-15 cm of soil. Many other studies have reported on the extensive absorbing fine roots found in the Central Amazon, where they occur in humus layer (spodosols) or near the surface (oxisols), forming an about 10-30 cm thick mat on top of mineral soil or in the superficial organic soils horizons (Klinge, 1973; 1975; 1976; Stark and Spratt, 1977; Stark and Jordan, 1978; Jordan and Herrera, 1981). These feeder roots are laced into the dead organic matter by mycorrhizal fungi, which cycle the nutrients directly from the organic matter to the living roots, constituting a crucial nutrient conserving mechanism in the Amazon rainforest (Went and Stark, 1968; Schlesinger, 1997). The efficiency of mycorrhiza in digesting the forest litter, and making it readily available to the roots mat, results in the thin litter layer found on the surface of the forest floor, in spite of the otherwise abundant leaf fall characteristic of this forest.

In summary, the rapid decomposition of organic matter in these soils results in low-levels of humus, ensures quick nutrient cycling of nutrients in Amazonian soils (Lavelle, 1987) and constitutes a critical factor in its high productivity (Cuevas and Medina, 1986). Organic matter on the soil surface protects the soil against leaching, and small losses are compensated by nutrients deposition in rain-water (Pires, 1978; Herrera

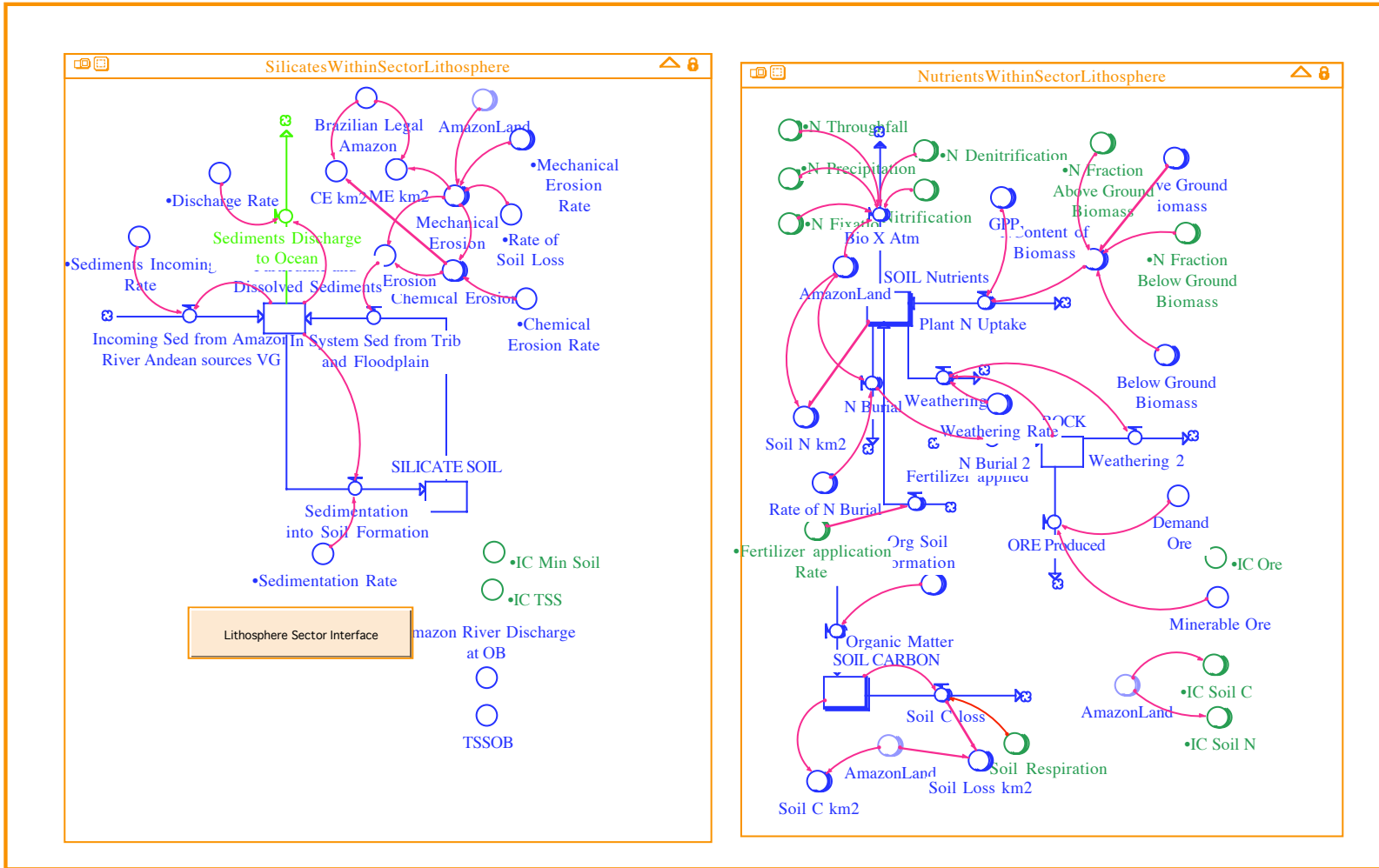

Figure 4.4. STELLA Diagram of the Lithosphere Sector of RUMBA.

et al., 1981). Herrera et al. (1978) describing the various mechanisms for nutrient conservation for forest ecosystems growing on the poor Amazonian soils, listed a) the dense root mat; b) the direct cycling from litter to the roots; c) the nutrient conservation by plant components; e) physiological adaptation to acid soils; f) arrangement of fallen leaves on forest floor; g) and the multi-layered structure of the forest. Indeed, studies of the nutrient balance of the forest showed that leaching of the nutrients from the Amazonian forest were less or equal the input from the atmosphere (Jordan 1982, Jordan 1985). Given the high potential for nutrient leaching of forests, it is conceivable that mechanisms for nutrient conservation are rather efficient in the Amazon (Vitousek, 1984; Vitousek and Reiners, 1975).

4.4.2. Carbon in Soils

The high efficiency of Amazonian low-nutrient soils in sustaining the productivity of autotrophs in this region makes modeling the soil carbon and nutrient reserves a particularly important aspect of RUMBA. Soil carbon storage, a significant part of the terrestrial carbon pool, becomes of foremost importance, given its potential role to act as either a source or sink of carbon. This is particularly relevant in the case of land use changes which have the potential to dramatically alter the organic matter content of soils, and to impact the dynamics of C and its release to the atmosphere (Bernoux et al., 1998a; Bernoux et al., 2001; Sombroek, 1993, Barbosa and Fearnside, 1999; Cerri et al., 2000).

The soil C storage is generally composed of a) soil inorganic matter (non-living); b) root carbon (living and undecomposed dead fine or woody component of roots; and c) charcoal and inorganic C (Khanna et al., 2000). The amount of C in litter may also form a significant portion of the total C in the soil, but often times is ignored in the studies of

soil C. Table 4.4. provides information on the average vegetation, litter and soil C content of forest and forest-derived uses in the Amazon.

In the lithosphere of RUMBA, soil carbon is a result of decay of carbon stored in the biomass (i.e. the dead organic matter), which is passed through the top, deep, and stable humus reservoirs, and lost to the atmosphere as respiration resulting from the decay processes (Elzen et al. 1997). Other below ground carbon, such as roots, are modeled within the autotrophs stock of the biosphere, and, as a result, are not accounted for in the lithosphere. The stock of Soil Carbon is therefore determined by the incoming flux of organic matter simulated in the Biosphere Sector and by the outgoing flux of carbon derived from soil carbon respiration (Equation 4.18, net change on soil carbon (T)).

[4.18]

$$d(\text{SOIL CARBON})/d(t) = \text{Organic Matter} - \text{Soil Carbon loss}$$

Table 4.3. Carbon Vegetation, Litter and Soil Content of Forest and Forest-Derived Uses (T km²) Used in the Biosphere Sector.

Land Cover/ Land Use	Carbon in the Vegetation	Carbon in the Litter Layer	Carbon in the Soil (0- 20cm)
Forest/Natural ecosystem	14,670 ^a	990 ^b	2220 ^c
Cropland in forest	405 ^d		
Pasture in forest	675 ^d		2660 ^c
Fallow in forest	1,973 ^d		2050 ^c

^a Fearnside (1997b).

^b Vitousek (1984a): Range 640 – 990.

^c McGrath et al. (2001).

^d Schroeder and Winjun (1995a).

4.4.3. Nitrogen in Soils

In terms of nutrient cycling, it is known that important nutrient elements present in a tropical forest include Nitrogen (N), Phosphorous (P), Potassium (K), Calcium (Ca)

and Magnesium. In RUMBA, I chose to simulate soil nutrients as the stock of Nitrogen in the soil for many reasons: a) the importance of the pattern of N circulation and efficiency for ecosystem level properties (Vitousek, 1982); b) the importance of N cycle in regulating the uptake and storage of carbon on land (Asner et al, 1997); c) the likelihood of impact on N cycling (and soil fertility) of processes of land cover change and land use management (Nye and Greenland, 1964; Jordan et al, 1972; Jordan and Kline, 1972; Fearnside, 1980; Herrera et al., 1981; Santos and Crisi, 1981; Werner, 1984; Allen, 1985; Brown and Lugo, 1990; Eden et al., 1990; Luizao et al., 1992; Neill et al., 1997; Reiners et al., 1994); d) the significance of the losses of N due to land use change in aquatic ecosystems and the atmosphere (Vitousek and Matson, 1984). Despite the relevance of N and its efficient cycling in tropical rainforest, it is important to point out that phosphorous (P), particularly low in most Amazonian sites, is most certainly a limiting factor on productivity (Vitousek, 1984; Vitousek et al., 1984). However, few studies are available on the role of P in the elemental cycles of both forest and forest-derived land uses (McGrath et al., 2001).

In tropical forest, plant litterfall represents the most important process of returning nutrients to the soil (Luizao 1989; Schlesinger, 1997). Leaves, followed by wood, fruits and flowers, contribute the most to the total of nutrients return (Franken, 1979). Nitrogen throughflow and stemflow, the amounts of nitrogen added to precipitation as it passes the canopy, are also important pathways for N return to the soils (Vitousek and Sanford, Jr., 1986). Nitrogen reabsorption by vegetation biomass can be eventually used in plants production and carbon uptake, increasing the efficiency of carbon fixed per nutrient uptake (Schlesinger, 1997). Two important microbial processes regulate the N return to

the atmosphere: nitrification and denitrification. According to Robertson (1989), nitrification and denitrification are particularly important in humid tropical ecosystems because of the direct and indirect losses of nitrogen they lead to, especially after vegetation clearing.

Inputs and outputs values found in the literature and used to inform parameters of RUMBA are displayed in Table 4.5. Annual Nitrogen precipitation in the Brazilian Amazon forest was reported to range between 0.6 – 1.0 T km⁻² (Vitousek and Sanford, 1986). Nitrogen fixation, the conversion of atmospheric N₂ gas to NO₃, varies considerably among the different soils and vegetation of the Amazon forest. High rates (about 20 T km⁻² yr⁻¹) have been reported for the seasonally inundated forests (varzea floodplains), intermediate rates for moderately infertile ultisols (about 2 T km⁻² yr⁻¹), and very low rates for the infertile oxisols (about 0.2 T km⁻² yr⁻¹). Annual net Nitrogen throughfall in the infertile oxisols/ultisols of Brazil were reported as about 0.7 T km⁻² (Vitousek and Sanford, 1986).

There are few studies on denitrification in the Amazon, but in situ research suggest that denitrification is higher where nitrogen mineralization is high (Robertson, 1989). Deforestation associated nitrification and denitrification can lead to high N losses. Uptake by vegetation was estimated in the model to be a function of the NPP and the N content of above and below-ground biomass. Processes of erosion and soil leaching of nitrogen from the top humus and deep humus to the groundwater, respectively, are modeled in the hydrosphere. Accumulation of nitrogen in the soil is also done by application of fertilizers.

In summary, Nitrogen taken from the atmosphere is stored in the biomass, returned to soil in the litterfall, humus layers, mineralized in top humus and immobilized by decomposer organisms, or returned to the atmosphere through nitrification and denitrification (Elzen et al., 1997; Post et al., 1985). In RUMBA, the Nitrogen present in the upper layer of soil (Equation 4.19, net change on soil nutrients (T)) derives from a) Bio X Atm-- the bio exchange of N with Atmosphere through process of N precipitation, N fixation, throughfall, denitrification and nitrification; b) Plant N Uptake-- transfers from soil to vegetation; c) N Hydrological Losses-- losses to the system due to leaching; and, d) Fertilizer applied-- the application of commercial fertilization.

[4.19]

$$d(\text{SOIL Nutrients})/d(t) = \text{Bio X Atm} - \text{Plant N Uptake} - \text{N Hydrological Losses} + \text{Fertilizer applied}$$

Finally, although RUMBA, for the purposes of simplification, does not explicitly simulate processes associated with the role of root mats and mycorrhiza in the forest, it is important to point out their role in the efficient use of nutrients within the poor forest soils, and the concerns that these mechanisms may be destroyed with land use changes associated with forest removal (Went and Stark, 1968). Indeed, Stark and Jordan's (1978) studies show that while most of "terra firme" forests had mycorrhizal fungi, the second-growth areas lacked them. Low nutrient stocks of soils together with the typical heavy rains and high temperature in the tropics and resulting susceptibility to erosion of soil when exposed are a matter of great concern with land cover change (Lavelle, 1987). Herrera et al. (1978) and Jordan and Herrera (1981) argue that the survival of the Amazonian ecosystems depends upon the maintenance of the nutrient conserving

Table 4.4. Nitrogen Content, Inputs and Outputs in the Brazilian Amazon Forest Used in the Biosphere Sector.

N Content Above Ground Biomass (T km ⁻²)	N content Below Ground Biomass (T km ⁻²)	N Content Fine Root (T km ⁻²)	N Precipitation (T km ⁻² yr ⁻¹)	N Litterfall (T km ⁻² yr ⁻¹)	N Throughfall (T km ⁻²)	N Fixation (T km ⁻² yr ⁻¹)	N Hydrologic Losses (T km ⁻² yr ⁻¹)
243.0	40.4	14.6	0.6 – 1.0	7.4 – 15.6	5.6 – 7.4	0.2 – 20.0	0.02

All values based on Vitousek (1984).

mechanisms, part of the living organic structure of the living forest and destroyed when the forest is cut.

4.4.4. Soil Erosion

Changes in the forest cover have an important effect on the soil physical and chemical structure. First, the lack of tree canopy to buffer rainfall leads to increased kinetic energy for moving soil by raindrops (Brandt, 1998) and to greater fluxes of water since evaporation is reduced (McLain and Elsenbeer, 2001). Less surface roughness, increasing soil compaction, reduced soil infiltration rates (Nortcliff et al., 1988) and increased runoff follow (Salati and Vose, 1984; Bunyard, 1987). The overall result of forest removal is not only the leaching of important nutrients and consequent soil impoverishment, but also an increase in sediments carried by rivers as soil erosion (Dickinson, 1987). Soil erosion, in turn, recent studies show, has been associated to increasing levels of surficial mercury concentration in aquatic systems in the Amazon (Roulet et al, 1998; Roulet et al, 2000; Roulet et al, 2001).

Large rivers play an important role in carrying out the products of erosion processes that are discharged into the oceans (Gaillardet et al., 1997). In the Amazon region, in particular, this role is played by the Amazon River and its main tributaries. Draining an area of approximately $6 \times 10^6 \text{ km}^2$, the Amazon River represents nearly 15% of the global runoff to the oceans, with a discharge estimated at $5.0 \times 10^3 \text{ km}^3$ per year (Mortatti and Probst, 2003). It is also the third largest river in the world in terms of sediment transport, discharging between 1.1×10^9 to 1.3×10^9 metric tons of suspended sediments per year to the ocean (Meade et al., 1985). A diversity of morphological

formations distributed in three major morphostructural zones characterize the river system and determine the difference in water quality across the basin: a) the Precambrian Shields; b) the Andean Cordillera; and c) the Amazon Trough (Mortatti and Probst, 2003).

The chemical characteristics of the water of rivers draining these formations determine the presence and quality of sediments and, as a result, the characteristic color of the water. Whitewater rivers, draining the Andes or sub-Andean trough, have high suspended sediments and dissolved loads. Both Solimões (Amazon main channel) and Madeira River are examples of the whitewater rivers. Clearwater rivers, widely-distributed within the basin, are depleted in suspended sediments and dissolved material. Blackwater rivers, low in suspended sediments and dissolved inorganic material but high in dissolved organic materials, are found in the low-land basin. The Negro river represents the main river draining that area. As a general rule, most of the suspended material transported in the Amazon River is composed of fine suspended sediments. The overall concentration of total suspended sediments (TSS) generally decreases downstream due to dilution by sediment poor water by tributaries of the Amazon depression and sub-Andean regions (Richey et al., 1986).

4.4.4.1. Chemical and Mechanical Erosion

In general, two major erosion processes determine the type of sediments carried out by rivers. Chemical erosion, associated with the dissolved river transport, contributes to the deepening of the soil weathering (i.e. soil formation). Mechanical erosion, in turn, associated with particulate river transport, contributes to the reduction of the soil thickness (i.e. soil loss) (Mortatti and Probst, 2003). While GUMBO simulates the flux

of erosion from biomes, RUMBA makes an explicit distinction among mechanical and chemical erosion. The model assumes that mechanical erosion is a function of land cover and assigns a baseline erosion factor to undisturbed land. Average erosion rates for human uses of land were then assigned based on a spectrum that assumes highest erosion rates to pasture land, as proposed by Barbosa and Fearnside (2000). Chemical erosion is estimated to be a fraction of the mechanical erosion.

RUMBA models erosion using this concept by simulating a rough mass balance of suspended and dissolved sediments for the basin close to its discharge into the Atlantic ocean at the Obidos station. The mass balance used in the model follows a model proposed by Richey et al. (1991) and Mortatti and Probst (2003), which estimates the amounts of sediments transport (both suspended and dissolved) from the Amazon basin based on measurements of water flow, sediments and chemical concentrations at different points along the Amazon mainstream between Varzea Grande (Andean sources) and Obidos (Atlantic Ocean). Following this model for the station closest to water discharge into the ocean (Obidos) gives a good picture of the overall magnitude of sediments from the basin. Inputs come from upstream (Incoming Sediments), and from catchment area via major tributary, local channel and floodplain input (In System Sediments); outputs are flows going to the ocean (Sediments Discharge) or to the pool of silicate soil (Sediments into Soil Formation). Mechanical and chemical erosion contribute to the catchment sources of erosion (Equation 4.20, sediments from tributaries and floodplain (T)). The net change in sediments (T) over time is simulated as shown in Equation 4.21. Because savanna cover is to a great extent located in the southern portion of the region, and likely

outside the drainage area of the Amazon Basin, in the RUMBA sediments are simulated only for the area of the Brazilian Legal Amazon originally under forest cover.

[4.20]

In System Sediments (Tributaries and Floodplain) = Chemical Erosion + Mechanical Erosion

where

Chemical Erosion = Dissolved river transport from tributaries and floodplain of forest cover area and its land uses

Mechanical Erosion = Particulate river transport from tributaries and floodplain of forest cover area and its land uses

[4.21]

d(Particulate and Dissolved Sediment)/d(t) = Incoming Sed from Amazon River Andean sources + In System Sed (Tributaries and Floodplain) - Sediments Discharge to Ocean - Sedimentation into Soil Formation

where

Incoming Sed from Amazon River Andean sources = Sediments from the Andean region as measured at VG station

Sediments Discharge to Ocean = Sediments discharged at ocean as measured at Obidos station

Sedimentation into Soil Formation = Sediments that contribute formation of soil in flooded areas

4.5. The Hydrosphere Sector of RUMBA

The hydrosphere module of the RUMBA, like that of GUMBO, accounts for biome-specific stocks of water, carbon and nutrients in surface and subsurface water bodies (Boumans et al., 2002). In this module the hydrological cycle is modeled as the water storage in the surface and groundwater, both as unsaturated and deep (ground) water. Water flows between these compartments, and among them and the atmosphere. Processes of precipitation and evaporation are determined by moisture content in the atmosphere, temperature and vapor pressure (Brooks et al., 1997). Overland and subsurface fluxes, together with transpiration, determine the different water storages and the water balance of the region. An overview of this sector is provided in Figure 4.5.

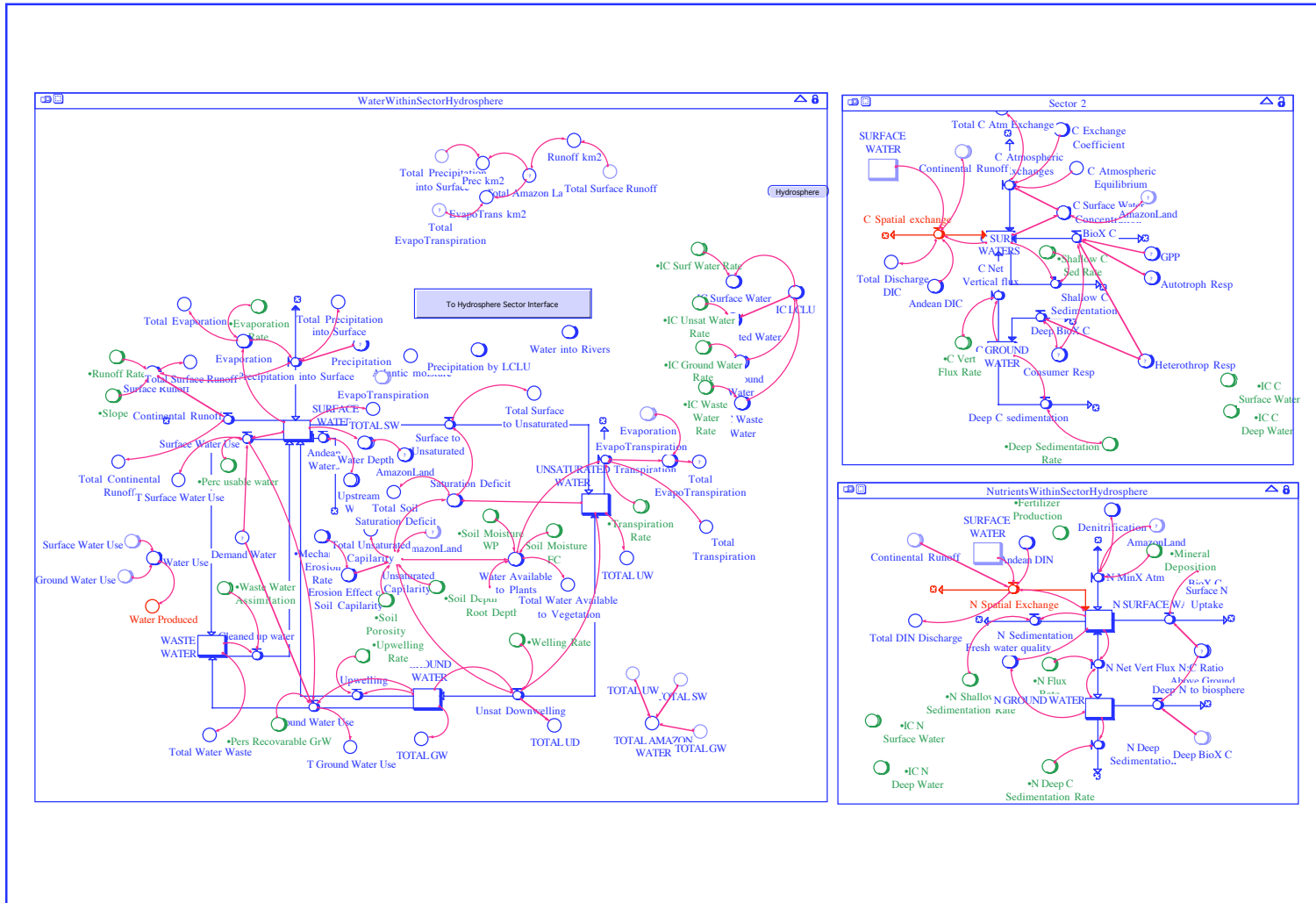

Figure 4.5. STELLA Diagram of the Hydrosphere Sector of RUMBA.

4.5.1. Water

Precipitation is the major input to a watershed, determining its water fluxes and storages (Brooks et al., 1997). Although occurrence of precipitation is primarily the result of meteorological factors, its deposition is strongly influenced by the vegetation cover and land uses (ibid). In tropical forests a large quantity of this water input is caught and returned to the atmosphere (interception) by the multilayered structure of forest canopy. In such forests, the process of interception is extremely important in determining how much of the gross rainfall reaches the forest floor either through intercepted water flowing through stems (stemflow) or by gaps in the canopy (throughfall) (Longman and Jenik, 1987). For instance, a partitioning of precipitation in El Verde, Puerto Rico, showed that interception values range between about 27 – 38 percent of gross rainfall, while throughfall ranged between 62 – 73 percent (Longman & Jenik, 1987). Stemflow was estimated as zero to one percent of gross rainfall (ibid). Once the water reaches the forest floor it accumulates on the surface, moves into soil and to the groundwater, or flows among these different water storages. Intercepted water and water reaching the forest floor returns to the atmosphere through two main processes: evaporation and transpiration. Evaporation refers to the water returned to the atmosphere from soils, water bodies and from plant surfaces, while transpiration refers to water lost to atmosphere by plant leaves through leaf stomata (Brooks et al., 1997). Collectively, these two processes are simply referred to as evapotranspiration.

In RUMBA, all water falling as precipitation is promptly accumulated as surface water. Surface water represents the storage of precipitated water intercepted by the plants, reaching the soil surface of the terrestrial land cover/uses depicted in the model, or falling

directly into other water bodies such as those of lakes and rivers (Equation 4.22, net change on surface water (m³)). Once in this storage, water is either returned to the atmosphere through evaporation, runs out of the spatial areas of the land cover/land uses through runoff, or flows into the soil becoming unsaturated water storage.

[4.22]

$$d(\text{SURFACE WATER})/d(t) = \text{Andean Waters} + \text{Precipitation into Surface} - \text{Surface to Unsaturated} - \text{Surface Water Use} - \text{Continental Runoff} + \text{Cleaned up water} + \text{Upwelling where}$$

Andean Waters = Incoming water from the Andean region

Precipitation into Surface = Incoming water from rainfall

Surface to Unsaturated = Surface water reaching unsaturated water

Surface Water Use = Surface water consumed

Continental Runoff = Surface water running on all land cover/land uses eventually discharged at the ocean

Cleaned up water = Waste water cleaned by natural processes and returned to surface

Upwelling = Groundwater reaching surface water

Evaporation can be estimated solely based on the amounts of water intercepted by vegetation, since the loss of soil water can be ignored (Villa Nova et al., 1976; Jordan and Heuveland, (1981). In the model, evaporation is a function of the overall amount of the land cover/land uses surface water storage, as well as of their interception ability, which is determined by an evaporation rate. The volume of water under runoff is also determined by the runoff rate of vegetation, as well as by the slope of land and the overall precipitation amounts falling on the land cover/uses (Equation 4.23, runoff (m³)). The sum of runoff on all land cover/land uses determine the overall amount of continental runoff, or water that is discharged at the ocean. In reality, runoff water on any terrestrial land cover/land use flows into a river land cover and is eventually discharged into the ocean. However, for the purpose of simplification, and given the arrays format of land cover/land uses of RUMBA, as describe I chose to model continental runoff as water inputs on all land cover/land uses.

[4.23]

$$\text{Runoff} = \text{Runoff Rate} * \text{Precipitation into Surface} * \text{Slope}$$

where

Runoff Rate = Average rate of runoff on land cover/land uses

Slope = Average slope of land cover/land uses

Unsaturated water is the subsurface water storage (above water table) infiltrated from surface water according to the unsaturated deficit of the land surface. This flow is determined by a saturation deficit ratio, or the difference between the unsaturated capillarity minus the actual unsaturated water storage at any given year (Equation 4.24, saturation deficit (m^3)). In other words, if the unsaturated water storage is below the unsaturated capillarity, water will flow from the surface water to unsaturated water storage.

[4.24]

$$\text{Saturation Deficit} = \text{Unsaturated Capillarity} - \text{Unsaturated Water}$$

where

Unsaturated Capillarity = maximum volume of water a soil can hold within soil pores

Unsaturated capillarity is generally estimated as a function of soil depth and porosity, and simulated in GUMBO as a function of both parameters. In the RUMBA, modifications were made to soil water storage capacity simulation (Equation 4.25, unsaturated capillarity) to better account for effects associated with human uses of land and resulting soil degradation. Frequent burnings and resulting erosion and leaching of nutrients contribute to the degradation of soil and its reduced ability to hold water (Nobre et al., 1991). As simulated in the lithosphere, this effect of land use on soil capillarity is modeled in the RUMBA by means of a rate of soil loss (mechanical erosion) as a proxy for the soil degradation.

[4.25]

$$\text{Unsaturated Capilarity} = (\text{AmazonLand} * (\text{Soil Depth} * \text{Soil Porosity})) / \text{Erosion Effect on Soil Capilarity}$$

where

Soil Depth = Vertical distance into the soil from the surface to a layer to which plant roots reach

Soil Porosity = Volume percentage of the total soil bulk not occupied by solid particles

Erosion Effect on Soil Capilarity = Effect of erosion on the physical attraction of soil pores to water

Unsaturated water is returned to the atmosphere through transpiration. However, unlike the original GUMBO, in which transpiration is a direct function of the total unsaturated water storage, GUMBO transpiration is based on unsaturated amounts of water that are available to plants and that can be reached by plants roots (Equation 4.26, transpiration (m³)). In other words, available water content in the soil as well as the uptake by vegetation roots determine the amounts of transpiration in the different land cover/uses of Amazon.

[4.26]

$$\text{Transpiration} = \text{Water Available to Plants} * \text{Transpiration Rate}$$

where

Water Available to Plants = Volume of water available to plants based on soil moisture, unsaturated capillarity and root depth

The soil water available to plants is estimated as a function of soil moisture field capacity, wilting point, unsaturated capillarity and root depth (Equation 4.27, water available to plants (m³)). Root depth, in turn, is a function of vegetation. Pasture, for example, has a much sparser and shallower root system than forest, being unable to access the deep unsaturated water storage (Nobre et al., 1991). Values of some of these parameters for land cover forest and savanna are provided in Table 4.6.

[4.27]

$$\text{Water available to Plants} = (\text{Soil Moisture FC} - \text{Soil Moisture WP}) * \text{Unsaturated Capillarity} * \text{Root Depth}$$

where

Soil Moisture FC: upper limit of water available to plants
 Soil Moisture WP: the lower limit water available to plants

Table 4.5. Values of Parameters/Property or Field Used in the Hydrosphere Sector.

	Forest	Savanna
Soil porosity	0.42 ^a	0.42 ^b
Soil depth (m)	3.5 ^a	-
Soil moisture fraction at wilting	0.29 ^b	0.31 ^b
Soil moisture fraction at field capacity	0.70 ^b	0.68 ^b
Root depth (m)	1.0 ^b	0.5 ^b

^a Nobre et al. (1991).

^b Walker et al (1995).

Human uses of surface and ground water are determined by water availability in these storages and by a demand ratio. Such uses incur production of waste water, accumulated as the waste water storage. In the RUMBA waste water is purified at a rate set by the waste water assimilation ability of water bodies, a function that is relative to amounts of waste in these bodies. This ecosystem service refers to nature's ability to recover mobile nutrients, and remove or breakdown excess xenic nutrients and compounds (Costanza et al., 1997).

In the hydrology sector, carbon and nutrients (i.e. nitrogen) accumulate and flow between the surface and ground water, and from the surface water to the atmosphere, lithosphere, and biosphere in all land covers/land uses. The carbon and nitrogen budget in water storages are essentially a function of inputs from surrounding terrestrial systems, exchange of gas with the atmosphere, shallow sedimentation, and deposition into subsurface waters. In contrast to a real system, the fluxes of water, carbon, and nutrients in the hydrology sector are not represented in RUMBA within the river land cover (another array of the model). Instead, they are represented separately within each land cover/land use. As a result, overall discharges are the sum of all storages of carbon or nutrients within all land uses, and not that of the river land cover.

Generally speaking, three primary factors determine the cycling of biogeochemically important elements in waters: source, physical processing, and biogeochemical reaction (Devol and Hedges, 2001). Sources of chemicals to the surface waters are organic matter from surrounding uplands and riparian zones, i.e. leaves and plant roots, and dissolved organic compounds from adjacent soils, i.e. amino acids, humic and fulvic acids (Schlesinger, 1997). Carbon and nutrients are transported into water as dissolved ions (mostly from rainfall and soil solution) and particulates (a subproduct of mechanical weathering), either in their organic or inorganic form (Meybeck, 1982; Schlesinger, 1997). Carbon is usually transported as dissolved inorganic carbon (DIC), particulate inorganic carbon (PIC), dissolved organic carbon (DOC), and particulate organic carbon (POC). Dissolved inorganic nitrogen (DON) – the sum of NO_3 , NO_2 , NH_4 , and dissolved organic nitrogen (DON) – are the nitrogen forms commonly found in waters (Meybeck, 1982). Particulate organic matter entering river waters mostly from litterfall, slumping and erosion (Richey, 1983) is leached by microbial activity and further processed by invertebrates as they move downstream (Wagener et al., 1998). This is why the ratio of dissolved to particulate organic carbon tends to increase as materials are degraded downstream.

Amazonian waters chemical characteristics and transport is largely based on the previously described whitewater, clearwater and blackwater rivers, respectively draining the Andean, central plateau, and Planalto das Guianas geomorphological zones (see lithosphere sector). In the following section, the Amazon river and its várzea (floodplains areas) are discussed in further detail to present an overview of the characteristics of surface waters in this system. I chose to use the Amazon River for three important

reasons: 1) the role of the river as an "integrator" of basin-wide activities (Richey, 1983; Richey et al. 1990) with nearly 1,000 tributaries (Salati and Vose, 1984); 2) its magnitude as the largest river in the world in discharge, with an average annual discharge estimated as $5.1 \times 10^{12} \text{ m}^3$, approximately 15 - 20% of the riverine discharge to oceans (Hedges et al, 1986a; Costa et al, 2002); and, 3) its relative uniform hydrograph, with small differences between minimum and maximum discharges (Richey et al., 1989; Richey et al., 1991; Richey et al., 1995).

The relatively uniform discharge of the Amazon River is due to the seasonal differences in precipitation in the north and south tributaries, and the consequent phase lag in peak flows, as well as the storage capacity of the floodplains. Average minimum and maximum water discharges of the Amazon River near its mouth (Obidos) over a 15-yr period were $100,000 \text{ m}^3/\text{s}$ and $220,000 \text{ m}^3/\text{s}$ (Richey et al, 1991). River height fluctuates by 10 – 20 m, with maximum height in May or June, and minimum in October or November (Wissmar et al., 1981). The average depth of the river is 20 m (maximum depth is 100m), average width 5 km and a gradient of 1 cm/km (ibid). The Amazon River transport of chemicals shows seasonal patterns that are either directly or inversely related to discharge (Richey et al, 1980).

The floodplains of the Amazon River, in turn, play an important role in the hydrology and biogeochemistry of carbon and nitrogen in the region, storing large volumes of water during the seasonal floods and returning it to the main channel when the river levels fall. They are also extremely important in retaining and recycling nutrients and in providing nutrition to consumers within the system (Melack and

Forsberg, 2001). These exchanges of water imply substantial exchanges of sediments, organic matter and nutrients between rivers and flooded areas (Martinelli et al., 2003).

Autotrophic production in the floodplains is represented by the annual production of phytoplankton (beds of floating macrophytes developed in the high waters), periphyton algae as well as the flooded forest tree production (Melack and Forsberg 2001).

Production by rivers is limited to primary production of plankton. The shallow lakes, swamps and dense beds of floating aquatic macrophytes in the flooded areas have potential for CH₄ production (Devol et al, 1988; Devol et al., 1990; Barlett et al., 1990). Microbiological processes such as N fixation and denitrification are also important processes in such wetlands (Kreibich and Kern, 2003).

Tree leaves are considered the main source of organic matter in the river, being transported as POC or DOC (Devol and Hedges, 2001). POCs, as well as other particulate nutrients carried in suspension (Richey et al., 1991), are eroded from and deposited into flood plains many times (Martinelli et al., 2003) before exported to the ocean, undergoing extensive alteration as they travel downstream (DeMaster and Aller, 2001).

The Amazon River discharge of organic matter is a potentially important contribution to the sediments of the ocean (Hedges et al, 1986a; Hedges et al, 1994). In the Amazon River, concentrations of particulate chemicals are directly proportional to TSS (Devol and Hedges, 2001) and the deposition of such nutrients as the result of annual flooding leads to the high productivity of the extensive Amazonian floodplain (Richey, 1983). DOCs are generally the sub-product of decomposed leaves and plant roots and humic and fulvic acid from soil organic matter released by microbial

degradation (Schlesinger, 1997). Humic acids, a particularly important source of DOC in the Amazon River, originate in black water rivers of the basin and compose nearly 60% of the DOC of that river (Ertel et al, 1986; Schlesinger, 1997).

4.5.2. Carbon

Because of the characteristic source of organic carbon in waters is dead organic matter from surrounding terrestrial systems, I chose to model particulate and dissolved organic carbon in the biosphere sector of the RUMBA, similar to the GUMBO model. This way, particulate and organic matter fluxes into water, and their overall discharge to ocean, are the result of the spatial exchange of a portion of the dead organic matter storage. However, unlike GUMBO, RUMBA accounts for the important input of chemicals from outside the Amazon region. For this reason, a flux of organic carbon entering the Amazon River (TOC) from Andean sources was added to the Biosphere Sector organic carbon simulation. Richey et al. (1990) estimated that an average of $1.21E+07$ T of carbon per year from Andean sources is added to the Amazon River.

Indeed, Andean weathering is the main source of chemicals to the Amazon River, particularly that of DIC, the most abundant form of carbon in the Amazon River (DeMaster and Aller, 2001), composed mostly of bicarbonate and dissolved CO_2 gas (Devol and Hedges, 2001). There is virtually no particulate form of inorganic carbon in the Amazon River (ibid). The inorganic carbon balance modeled in the hydrosphere is therefore determined by inputs of: 1) carbon transported in the surface waters (DIC) from upland sources (Andes); 2) river tributaries and floodplain, and the groundwater; 3) losses by permanent burial and emissions to the atmosphere (CO_2 , CH_4); and 3) exports to the ocean at river mouth (Equation 4.28, net change of C in surface waters (T)). Total

input of inorganic carbon from Andean sources is nearly twice as much as that of organic carbon, averaging 2.07×10^7 T of carbon per year (Richey et al., 1990).

$$d(C \text{ Surface Waters})/d(t) = C \text{ Net Vertical flux} - C \text{ Atmospheric Exchanges} - \text{Shallow C Sedimentation} - \text{BioX C} - C \text{ Spatial exchange} \quad [4.28]$$

where

C Net Vertical flux: Carbon inputs from groundwater

C Atmospheric Exchanges: Net C exchange with the atmosphere

Shallow C Sedimentation: Carbon losses through shallow sedimentation

BioX C: Net C exchange with land cover/uses as a result of autotrophs and heterotrophs activity

C Spatial exchange: Net C flux from inputs from Andean sources, runoff and discharge to the ocean

Primary producers play an important role in providing inputs of carbon to the water and to supporting consumers, especially in the middle reaches of streams and in large water bodies. Microbial respiration of high-quality carbon, in turn, is an important process as water moves downstream. Bioexchange rate of production (T) occurring in the waters of flooded forest and lakes, as well as in the rivers, is simulated using Equation 4.29.

$$\text{Bio Exchange Carbon} = \text{GPP} - \text{Autotroph Resp} - \text{Consumer Resp} - \text{Decomposer Resp} \quad [4.29]$$

In the model, the exchange of carbon between the surface water and atmosphere (T) is determined by the carbon surface water concentration, the atmospheric equilibrium, and by an exchange coefficient, using a simple gas transfer model based on a model provided by Richey et al. (2002), and described on Equation 4.30.

$$\text{Carbon Atmospheric Exchange} = C \text{ Exchange Coefficient} * (C \text{ Surface Water Concentration} - C \text{ Atmospheric Equilibrium}) \quad [4.30]$$

where

C Exchange Coefficient = Carbon exchange coefficient with atmosphere of Amazon river mainstream, tributaries and floodplain

Exchanges of surface water carbon between the hydrosphere and atmosphere is particularly important for the Amazon region. The large water bodies of the Amazon are supersaturated with carbon dioxide with respect to the atmosphere leading to significant losses of carbon (Richey, 1983; Richey et al., 1988; Richey et al., 2002). Indeed, the river CO₂ gas concentration is estimated at 150 - 250 μm, whereas the atmospheric equilibrium CO₂ concentration is about 10 μm (Devol and Hedges, 2001). These exchanges of gas are expected to play an important role on the net flux of carbon between the Amazon and the atmosphere (Grace and Malhi, 2002; Richey et al, 2002).

Finally, RUMBA simulates shallow sedimentation of the surface water carbon, the vertical flux of carbon between surface and deep water (groundwater), and deep sedimentation of carbon from ground water storage, following specific rates that determine such fluxes.

4.5.3. Nitrogen

RUMBA simulates the storages and fluxes of nitrogen in the surface and ground waters following a model similar to that employed for carbon. Nitrogen in the surface water is the result of wet and dry deposition from the atmosphere, upland runoffs, solutes and particulates carried out by the rivers, groundwater seepage, and fixation by bacteria. Nitrogen is released from surface waters back into the atmosphere through denitrification. The net change of N in the surface water is described in Equation 4.31 (T). Exchange of nitrogen with the atmosphere is essentially a function of deposition, nitrogen fixation and denitrification ($N_{MinX Atm}$). Exchange of N between surface and deep ground water storages ($N_{Vert Flux}$) as well as shallow sedimentation of N ($N_{Sedimentation}$) are determined by specific rates. Nitrogen in subsurface water is also a function of the carbon

respired by decomposers, consumers in this storage, and of the C/N ratio (N Uptake).

Finally, similar to carbon, inflows and outflows of nitrogen from the land uses are

described as N Spatial Exchange.

[4.31]

$$d(N \text{ SURFACE WATER})/ d(t) = N \text{ MinX Atm} - N \text{ Net Vert Flux} - N \text{ Sedimentation} - \text{Surface N Uptake} - N \text{ Spatial Exchange}$$

where

N MinX Atm = Net N exchange with the atmosphere

N Net Vert Flux = Net N exchange with groundwater

N Sedimentation = Nitrogen losses through sedimentation

Surface N Uptake = Net Nitrogen uptake by autotrophs and heterotrophs activity

N Spatial Exchange = Net Nitrogen flux through inputs from Andes, runoff and discharge to ocean

Nitrogen is found in both particulate and dissolved forms in waters, as well as in its organic and inorganic forms. In the Amazon River, about 60% of the nitrogen is dissolved, and evenly distributed among its organic and inorganic form. In RUMBA, similarly to organic carbon, organic nitrogen is dealt within the biosphere. The inorganic dissolved nitrogen is composed of nitrate (NO₃) and ammonium (NH₄), the forms described within the surface waters of the hydrosphere sector. Nitrite (NO₂), also an inorganic dissolved carbon, is a negligible contributor to inorganic nitrogen in surface waters (Lewis Jr. et al., 1999) and is not considered in this study. According to Richey et al. (1991), nitrate is the dominant form of combined N in the Amazon River, ranging from 5 – 25 µmol/l across sections of the river. Ammonium, in turn, ranges between 1 – 2 µmol/l. Based on Forsberg et al. (1988), I estimate the amount of inorganic carbon from Andean sources to average 3.14E+05 T of Nitrogen per year.

Most of studies describing nitrogen in Amazonian waters point out the seasonal and regional variations of water and nutrient concentrations in the rivers and floodplains.

Some important generalizations are as follows. First, most nutrients in the rivers, lakes and flooded forest of Amazonian floodplains are from biogenic sources (Melack and Forsberg, 2001). Anthropogenic disturbance, either from atmospheric deposition or anthropogenic disturbance is negligible (Lewis Jr. et al., 1999). Second, internal recycling in the lakes and floodplains is an important process, often times exceeding the external supply from the rivers (Melack and Forsberg, 2001). Third, nitrogen availability, like that of carbon, is highly dependent on the characteristics of the white water, black water and clear water rivers from which it is formed, and highly dependent on water levels (Melack and Forsberg, 2001). During high-water levels, river water enters the flooded forest and lakes, increasing their depth substantially and turning the chemical compositions of their waters, specially that of nitrogen, similar to those of the water from their parent rivers (Forsberg et al., 1988).

As a general rule, the flooded forests of the Amazon (*várzeas*) are rich in nutrients available for plant growth, although nutrient supply varies with hydrological cycle, with lowest levels found in receding waters (Kreibich and Kern, 2003). However, although lakes and flooded forest in the Amazon receive nitrogen from the flooding waters of the rivers, the majority of nitrogen in some lakes in the Amazon is provided by local sources. For instance, the floating macrophytes surrounding many of the lakes may represent an important source of nutrients during the low water, either by their decomposition and liberation of nutrients, or by their ability to actively fix nitrogen (specifically that of leguminous macrophytes) (Forsberg et al., 1988). A mass balance of nitrogen in Lake Calado in central Amazon in 1984-1985 showed that 43% of the total nitrogen budget in the lake was provided by local surface runoff, followed by inputs from the Amazon River

(35%), direct rainfall (9%), adjacent lakes (8%) and groundwater (5%). Losses of total nitrogen in turn were mostly associated with outflow (64%), burial (31%) and groundwater seepage (5%) (Melack and Forsberg, 2001).

Exchange of water (and nutrients) in the flooded forests is a crucial process in determining production, but so may be the processes of fixation and denitrification. Kreibich and Kern (2003) study on a floodplain forest near Manaus showed that, on average, three times more N was lost via denitrification than gained by N fixation in a year, and that both processes suffered high seasonal variability due to flood pulse. Yet, much uncertainty exists on the processes associated with biogenic gases in the region. According to Melack and Forsberg (2001), only selected sites of the Amazon present the conditions conducive to intermittent denitrification. Such sites include those of shallow sediments exposed to air.

A mass balance of nitrogen for the entire region by Salati et al. (1982) showed that denitrification losses are quantitatively more important than regional hydrologic losses in the Amazon. Since denitrification has not been extensively studied in the Amazon (Esteves et al., 2001) and since it is controlled by seasonality of water, a clear and definitive pattern is difficult to draw. As a general rule, however, nutrients carried out by streams are a good indicator of nutrient status before and after land use change (Bruijnzeel, 1991).

An example of a mass balance of nitrogen cycling in a small watershed of Amazon terra firm (forest) is shown in Table 4.7. (Jordan et al., 1985). N fixation is the main input (59%), followed by the combined deposition of $\text{NH}_4\text{-N}$ and $\text{NO}_3\text{-N}$ in precipitation (41%). Leaching of $\text{NH}_4\text{-N}$ and $\text{NO}_3\text{-N}$ and denitrification are equivalent to

51% and 10%, respectively, of the incoming nitrogen in the system. Remaining nitrogen is accumulated within the system. Another study by Likens and Borman (1999) showed that the overall stream-water losses of nitrogen from an Amazon site (Rio Negro) were about 84% of the incoming precipitation. Lesack and Melack (1996), finding excess of nutrient inputs via rainfall over ecosystem outflow, suggest that interannual variability in the volume of water running of the system and entrainment of materials from terrestrial ecosystem to the atmosphere might explain budgets that do not follow the nutrient retention hypothesis, as proposed by Vitousek and Reiner (1975). According to this hypothesis, a balance should exist between uptake and release of nutrients from an ecosystem if such a system is not aggrading or senescing. (ibid).

Interesting conclusions can be derived from Likens and Borman (1999) study of nutrients in forest ecosystems in many parts of the world: 1) precipitation is often times a significant addition to the nitrogen budget of forest ecosystem; 2) precipitation inputs of inorganic nitrogen exceed losses in water for forest ecosystems; 3) geologic substrates play an important role in the amount and composition of nutrients lost into surface waters; 4) amounts of precipitation and loss of nutrients in ecosystems with different climates are not closely correlated; 5) forest ecosystems have a conservative loss of nutrients relative to amounts cycled internally; 6) stream water losses may be significantly changed with anthropogenic disturbance.

Some of these conclusions seem to be observed by Lewis Jr. et al. (1999) in a study on the nitrogen yield from undisturbed watersheds in the Americas. Their results point to yields of total nitrogen that are strongly and positively correlated to amounts of runoff, which, in essence, is a function of vegetation type. Precipitation is thought to play

an important role on the N deposition and fixation rates, as well as on N release from decomposition. Anthropogenic disturbances of the cycle through cutting and burning of the biomass are expected to cause changes in the nitrogen fluxes through destruction of N-fixing organisms, enhanced nitrification, and nitrate leaching (Jordan et al., 1985). Finally, such changes of the nitrogen cycling may have important consequences to the climate and atmosphere chemistry (Robertson and Rosswall, 1986).

4.6. The Atmosphere Sector of RUMBA

The atmosphere module of the RUMBA, like that of GUMBO, accounts for the regional energy balance, water storage and precipitation, and the dynamic exchanges of carbon and nitrogen between the atmosphere and the regional land covers (Boumans et al., 2002). The energy balance in the atmosphere accounts for the incoming solar energy on the surface, as well as the energy going back into the atmosphere. As a general rule, solar radiation reaching the Earth is either reflected back into space or absorbed by the atmosphere and surface. Solar energy provides the light necessary for photosynthesis and the temperature regimes that allow life on Earth, driving horizontal and vertical atmospheric movements, evaporation and precipitation (Barnes et al., 1998). Ultimately, all the energy reaching the Earth is radiated back into space, cooling the Earth and allowing for a constant average temperature. An overview of this sector is provided in Figure 4.6.

4.6.1. Energy

Similarly to GUMBO, the regional energy balance of RUMBA is simulated as the solar incident energy on surface, which is in turn reflected, absorbed or transmitted

(Boumans et al., 2002). Energy absorbed by the surface is the result of incident energy that is not redistributed among land covers or reflected back to the atmosphere.

Redistribution of energy among land covers occurs due to air and water circulation, as well as changes of land uses. Reflected energy is primarily a function of the surface temperature and heat retention capacity and emissivity. It is also a function of an increase of carbon in the atmosphere, and the likely ability of such a gas to cause warming of the atmosphere as a result of the greenhouse effect (Schlesinger, 1997).

In RUMBA the regional energy is simulated based on an energy balance model developed by Few (1996), as shown on Equation 4.32 (net change on energy per unit area ($J K^{-2}$)).

$$d(\text{Land Cover Energy})/d(t) = (\text{Solar to Earth} - \text{Land Cover to Atmosphere} - \text{Spatial Energy Flux}) \quad [4.32]$$

where

Solar to Earth = Amount of solar energy arriving land surface given land albedo property

Land Cover to Atmosphere = Amount of energy reaching surface that is emitted back to atmosphere

Spatial Energy Flux = Redistribution of energy among land cover/uses due to air and water circulation and change in uses

According to this model, solar radiation reaching the atmosphere at an average of $1,368 W m^{-2}$ (solar constant) is either radiated back to space according to reflective properties of the land cover/land uses (albedo) or stored as land cover/land uses energy (Equation 4.33, Solar to Earth energy ($J km^{-2}$)). A review of different climate simulation models for the Amazon region showed albedo parameters for the forested vegetation ranging from 10 – 14%, whereas that of the deforested areas ranged from 18- 20% (Lean and Warrilow, 1989; Shukla et al., 1990; Nobre et al., 1991; Dickinson and Kennedy, 1992; Henderson-Sellers et al., 1993; Lean and Rowntree, 1993; Polcher et al., 1994;

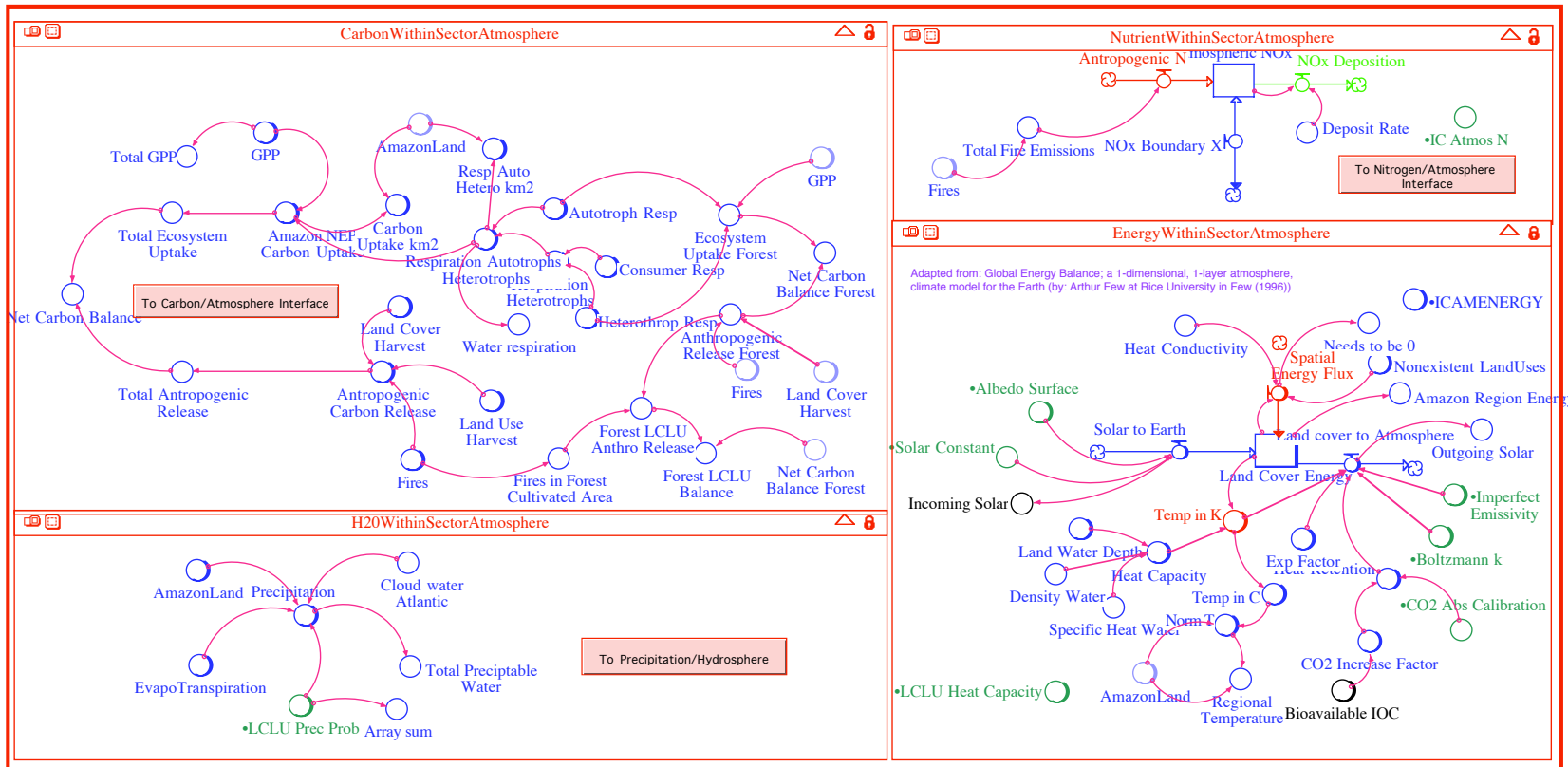

Figure 4.5. STELLA Diagram of the Atmosphere Sector of RUMBA.

Lean et al., 1996). I used these numbers to inform the albedo characteristics of the land cover/land uses described in the models.

$$\text{Solar to Earth Energy} = \text{Solar Constant} * (1 - \text{Albedo Surface}) * \text{AmazonLand} \quad [4.33]$$

where

Solar Constant = Amount of constant solar radiation

Albedo Surface = Reflective property of land cover/land use

Stored energy on the land cover/land uses is then radiated back into the atmosphere. The regional temperature is the temperature at which the energy flows into and out of the stored land cover/land uses energy are balanced (Few, 1996), as described in Equation 4.34 (temperature of land cover/use (K)). Temperature of the land cover/land uses is determined by the energy stored in the land cover, their overall area, as well as their heat absorption capacity.

$$\text{Temperature} = \text{Land Cover Energy} / (\text{Heat Capacity} * \text{AmazonLand}) \quad [4.34]$$

where

Heat Capacity = Stored thermal energy by land cover/land uses

The energy radiated into space is determined by the Stefan-Boltzmann constant (the total power radiated per unit area from a perfect black material at a uniform temperature), the land cover/land use area as well as their temperature (Equation 4.35).

$$\text{Land to Atmosphere Energy} = \text{AmazonLand} * (\text{Heat Retention} * \text{Imperfect Emissivity}) * \text{Boltzmann } k * \text{Temp in } K^{\text{Exp Factor}} \quad [4.35]$$

where

Heat Retention = Atmospheric retention of heat

Imperfect Emissivity = Coefficient of emitted energy from land cover/uses

Boltzmann k = Stefan-Boltzmann constant

Temp in K = Temperature in Kelvin

Exp Factor = Exponential factor (constant)

4.6.2. Carbon

The global stock of carbon in the atmosphere is calculated in the Global GUMBO as a mass balance equation based on the carbon dioxide emissions from fossil fuel burning and cement production, emissions from land use change, uptake by oceans and forest regrowth (Elzen et al., 1997; Boumans et al., 2002). In the RUMBA, I estimate the contribution of this region to the global carbon budget, by assessing the net uptake by natural ecosystems as well as the anthropogenic emissions associated with land use changes and burning of the vegetation. Mining aspects associated with carbon release, as well as the burning of the fossil fuels in the region, are not estimated due to their minor contribution to the regional carbon budget.

More specifically, in RUMBA the transfers of carbon between the atmosphere and the biosphere are dependent on the terrestrial biomass accumulation, decomposition and storage across the different land covers/land uses (Asner et al., 1997), as well as on deforestation and burning of forest (Schroeder and Winjun, 1995b). The model simulates the net ecosystem production (NEP) as a measure of the carbon uptake, by subtracting the autotrophic and heterotrophic respiration out of the gross primary production (Equation 4.36, Amazon net ecosystem production (T)). NEP is the annual carbon storage or loss of the natural ecosystem that is limited by nutrient, temperature, water, light, waste and carbon availability, as simulated in the Biosphere sector. Total ecosystem uptake of C on land cover/land uses refers to the net uptake of carbon for the entire region (Equation 4.37, (Total Ecosystem Uptake (Pg)).

[4.36]

$$\text{Amazon NEP Carbon} = \text{GPP} - \text{Respiration Autotrophs Heterotrophs}$$

where

GPP = Gross Primary Production

Respiration Autotrophs Heterotrophs = Sum of carbon respired by autotrophs and heterotrophs

[4.37]

$$\text{Total Ecosystem Uptake} = \text{ARRAYSUM}(\text{Amazon NEP Carbon Uptake [LC, LU]})/1e9$$

where

Amazon NEP Carbon Uptake [LC, LU] = Net ecosystem production on all land cover/land uses

Release refers to the anthropogenic disturbance and related CO₂ emissions, modeled as the fluxes of harvest that are not transformed into built capital (consumed organic matter) and that of fire emissions (Equation 4.38, anthropogenic release (T of C)). Total anthropogenic release is the sum of all C release on all land cover/ues (Equation 4.39, total anthropogenic C release (Pg of C)).

[4.38]

$$\text{Anthropogenic Carbon Release} = \text{Fires} + \text{Autotroph Net Harvest}$$

[4.39]

$$\text{Total Anthropogenic Release} = \text{ARRAYSUM}(\text{Antropogenic Carbon Release}[*,*])/1E9$$

Last, the net carbon balance (Equation 4.40, (Pg of C)) is the difference between ecosystem uptake and anthropogenic release.

[4.40]

$$\text{Net Carbon Balance} = \text{Total Ecosystem Uptake} - \text{Total Antropogenic Release}$$

Calculating the fluxes of carbon between the atmosphere and the biosphere in the Brazilian Amazon model is important given the role of this forest in the carbon dynamics of the region and of the world (Tian et al., 1998; Prentice and Lloyd, 1998; LBA, 1999). This is particularly true given recent evidence that atmospheric and climate change at the global scale might be driving changes in the forest dynamics and composition (LBA, 2003a). Regional drying and warming, and possible intensification of El Nino

phenomena (Philips et al, 1998a) will most certainly have an impact on the ability of the ecosystem to uptake/release carbon. Anthropogenic disturbances such as fragmentation and edge-effect mortality (ibid) will have similar impacts. The LBA project, a great scientific experiment across the Amazon basin, promises to elucidate the mechanisms associated with sink/source and its role in the global carbon cycle by investigating the climatologic, ecological, biogeochemical and hydrological functioning of the Amazon (LBA, 1999) and the impact of anthropogenic disturbances.

4.6.3. Nitrogen

The atmospheric stock of nitrogen is modeled in RUMBA as a result of precipitation, fixation, denitrification and emissions from anthropogenic sources (Equation 4.41, net change in atmosphere Nox (T of N)). In the model, N precipitation or deposition (NO_x Deposition) is modeled according to a deposition rate. The main source of anthropogenic nitrogen to the atmosphere is the biomass burning as a result of forest fires, modeled in RUMBA as Anthropogenic N. Nitrogen fixation, in turn, results from uptake by terrestrial systems, and the bioexchange of nitrogen with the atmosphere (NO_x Boundary). Uptake of nitrogen by plant is primarily a function of the available pool of inorganic nitrogen in the soil, while denitrification is the release of N gas occurring in anaerobic conditions. Both fluxes are modeled as N boundary exchange.

[4.41]

$$d(\text{Atmospheric NO}_x)/d(t) = \text{Anthropogenic N} + \text{NO}_x \text{ Boundary X} - \text{NO}_x \text{ Deposition}$$

where

Anthropogenic N = Emission of N through biomass burning

NO_x Boundary = Bio-exchange of N with the atmosphere

NO_x Deposition = Nitrogen precipitation

Fire regimes represent an important perturbation to the carbon-nitrogen cycle (Asner et al., 1997) in the tropics. Amazonian rain forest fires, in particular, are the result of the clearing of forest by farmers and pioneer settlers, who have transformed forest burning into a dominant and highly disturbing process in the region (Uhl and Kauffman, 1990). Setzer and Pereira (1991) estimated that 350,000 independent fires corresponding to about twenty million hectares of different types of vegetation burned in 1987 in the Brazilian Amazonian rain forest. These authors estimate that the biomass-burning emissions from the Amazonian rain forest is a substantial source of gases, causing significant changes in the climate and radiation absorption rates (ibid).

4.6.4. Water

Atmospheric water vapor storage is the amount of precipitable water in the atmosphere, as a result of transpiration, evaporation, and influxes of wind vapor transportation. In RUMBA, water is evapotranspired to the atmosphere from soil, water and plant storages (unsaturated water) as simulated in the Hydrosphere Sector of the model. Another source of water in the atmosphere is the evaporation of precipitation intercepted by plant canopy and of water accumulated on soil surface and soil-water storage (Brooks et al., 1997). These sources are also simulated in the Hydrosphere Sector of RUMBA. Finally, there is water vapor coming into the region as a result of trade winds (Salati and Vose, 1984). Equation 4.42 (precipitation ($\text{m}^3 \text{yr}^{-1}$)) adds all the fluxes of water in the atmosphere that precipitate in the landcover/land uses described in the model, according to a precipitation probability parameter.

$$\text{Precipitation} = (\text{EvapoTranspiration} + \text{Cloud water Atlantic}) * \text{AmazonLand} * 1E6 * \text{LCLU Prec Prob} / (\text{ARRAYSUM} (\bullet \text{LCLU Prec Prob} [*,*]) \quad [4.42]$$

Where

EvapoTranspiration = Atmospheric water evapotranspired from all land cover/uses

Cloud water Atlantic = Atmospheric water from ocean sources brought by trade winds

LCLU Prec Prob = Precipitation probability parameter for each land cover/land use

In the Amazon region, precipitation occurs as a result of both water vapor from the Atlantic Ocean and forest evapotranspiration. It is estimated that about 50% of precipitation in the region is due to water recycling through evapotranspiration (Salati, 1984; Zhang et al, 1996a), a process that is certain to be closely connected to the large area of the forest and its biomass density. Water vapor sources contribute in equal amounts to cloud formation and eventual rainfall (Salati et al., 1979; Salati and Vose, 1984; Salati and Nobre, 1991; Laurance, 1998). The physical barrier provided by the Andean mountains and the Guyana plateau (on the Western and Northern side of the basin) as well as the prevailing easterly winds explain the rainfall distribution of year-round precipitation in the East portion of the basin and the dry period in the Central and West portions (Salati and Vose, 1984; Salati and Nobre, 1991).

The spatially non-uniform patterns of precipitation in the Brazilian Amazon can be observed in the maximum annual precipitation occurring in the Northern hemisphere portion of the basin, followed by decreased rates in the Central Amazon, and increased rates in the western portion toward coastal Colombia. The pattern of temporal variability is associated with seasonal variations, with maximum rainfall in the Southern portion of the region occurring during the summer of the Southern hemisphere. The rains diminish from the summer on and as they move towards the Northern hemisphere (Salati and Marques, 1984). The average rainfall in the Amazon region is one of the highest pluviometric indexes in the world (Salati and Marques, 1984). A review by Leopoldo et

al. (1982) showed mean regional precipitation values ranging from 2,00 to 3,66 m yr⁻¹. Mean precipitation value recorded for the period of 1972 - 1975 was 2,33 m yr⁻¹ (Marques et al., 1980; Leopold et al., 1982).

Carbon, nitrogen and water mass balances of the atmosphere sector are an important synthesis and integration of natural and anthropogenic disturbances on the surface. Although certain, in particular the effects of major disturbances from anthropogenic activities on both the hydrological and biogeochemical cycles at regional and global scales are still not fully understood. Recent studies have shown an increase in the availability and mobility of nitrogen in large areas of the Earth (Vitousek et al., 1997), which, coupled with an increase of atmospheric carbon dioxide and temperature (Asner et al., 1997), results in the global warming effect (Raich et al., 1992). This pattern is more evident in industrialized countries, where high levels of nitrogen deposition appear to be causing nitrogen saturation in forest ecosystems (Fenn, 1998). In the tropics and in the Amazon in particular, on the other hand, evidence exists that frequent burning of biomass has substantially decreased nitrogen availability and increased the emission of carbon dioxide (Crutzen and Andreae 1990, Setzer and Pereira 1991, Asner et al. 1997).

4.7. Anthroposphere Sector of RUMBA

The anthroposphere module of RUMBA, like that of GUMBO, accounts for the human and social systems, their consumption of material and energy and discard of waste, as well as for the production process (Boumans et al., 2002).

The anthroposphere module of RUMBA, depicted on Figure 4.7a. and 4.7b., accounts for the human and social systems, their consumption of material and energy within the larger system and discard of waste in the production process (Boumans et al.,

2002). It is designed to encompass the human, social, physical and natural capital, as described below.

4.7.1. Human capital

Human capital is the knowledge and skills that humans bring to activities, and to the production process (Ostrom, 1999). In the RUMBA, human capital is simulated as the stock of human population and the formation and loss of knowledge that drives transformation of material and energy in the economy. Population is simulated as the influx of births, outflux of deaths and the flow of migration of humans into or out of the region (Equation 4.43, net change in population). The total number of births is based on a fertility rate that is positively correlated to the availability of food (Fertility Increase, Equation 4.44) and negatively correlated to increasing education levels (Fertility Decrease, Equation 4.45). Number of deaths – a function of mortality rate – is negatively correlated to improving health care (Mortality Decrease, Equation 4.46) and positively correlated to increasing amounts of waste and occurrence of hunger (Mortality Increase, Equation 4.47). Population determines the amount of labor force available in the economy.

$$d(\text{Human Population})/d(t) = \text{Human Births} + \text{Net Migration} - \text{Human Deaths} \quad [4.43]$$

$$\text{Fertility Increase} = \text{Food per capita} * F \text{ per } C \vee \text{Fertility} \quad [4.44]$$

where

F per C v Fertility = Index correlating food per capita to fertility

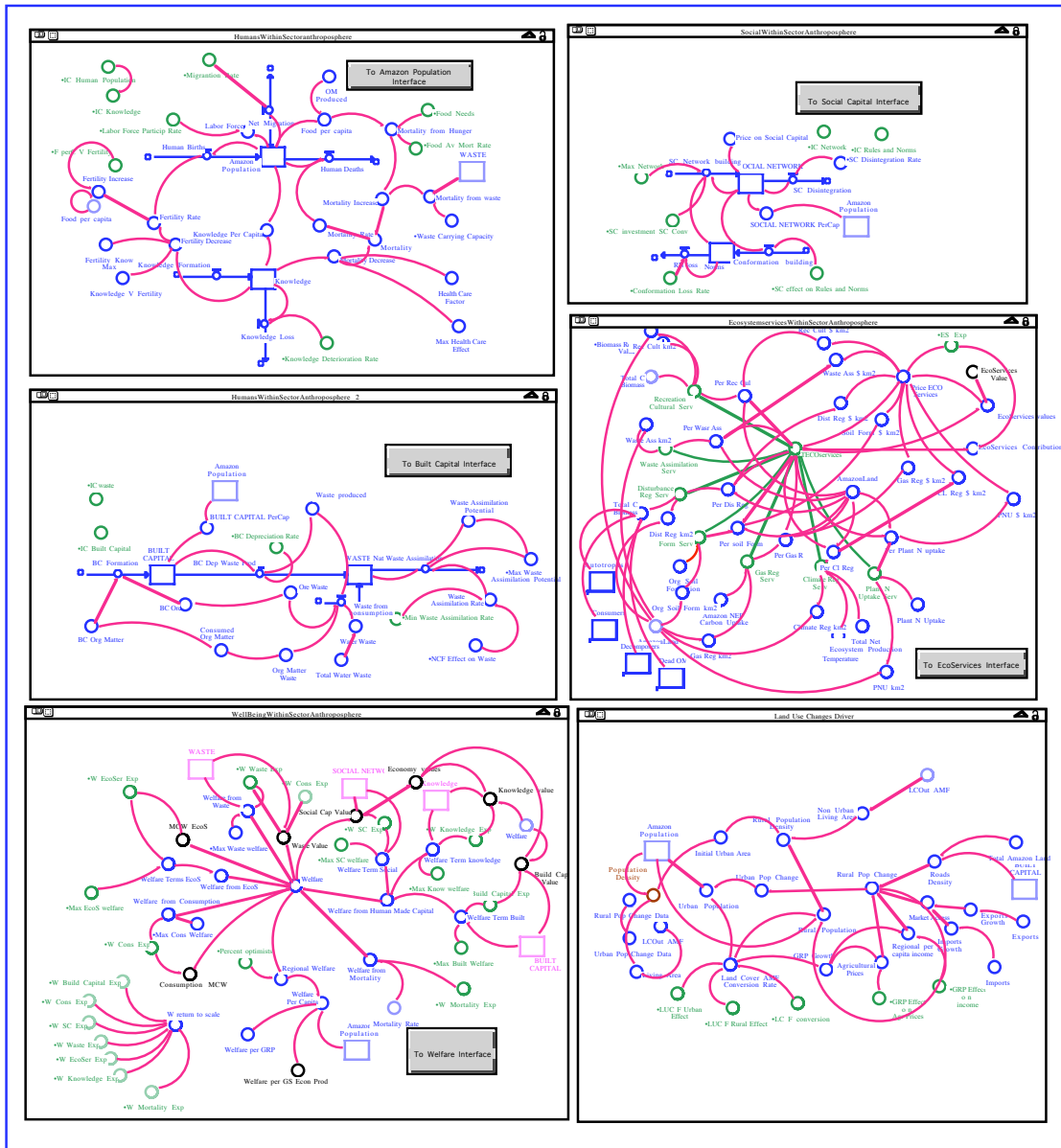

Figure 4.7a. STELLA Diagram of the Anthroposphere Sector of RUMBA/Capitals.

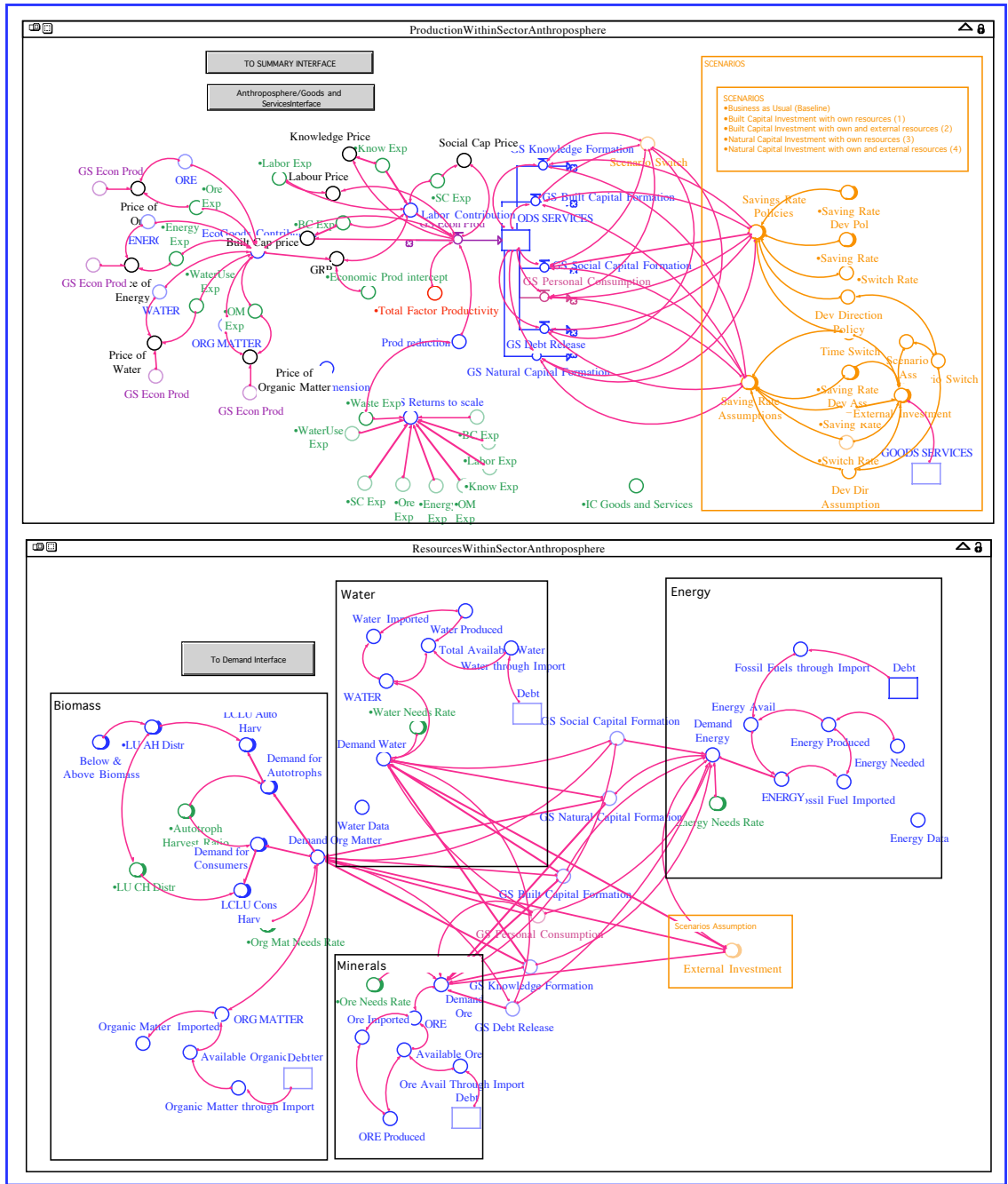

Figure 4.7b. STELLA Diagram of the Anthroposphere Sector of RUMBA/Economy.

$$Fertility\ Decrease = Fertility\ Know\ Max - Fertility\ Know\ Max / EXP(Knowledge\ V\ Fertility * Knowledge) \quad [4.45]$$

where
 Fertility Know Max = Index of maximum knowledge
 Knowledge V Fertility = Index correlating knowledge to fertility

$$Mortality\ Decrease = (Max\ Health\ Care\ Effect - Max\ Health\ Care\ Effect / EXP(Health\ Care\ Factor * Knowledge)) \quad [4.46]$$

where
 Max Health Care Effect = Index of maximum health care
 Health Care Factor = Index correlating health care to mortality

$$Mortality\ Increase = Mortality\ from\ waste + Mortality\ from\ Hunger$$

where
 Mortality from waste = Deaths associated with waste and lack of sanitary living conditions
 Health Care Factor = Deaths associated with hunger

The stock of knowledge, based on the formation of knowledge and its deterioration, is important in determining both human fertility and mortality decrease. Knowledge in the model is simulated as the stock of monetary resources invested on education.

4.7.2. Social capital

Social capital refers to the institutions, relationships, and shared norms that shape the quality and quantity of a society's social interactions (Boumans et al., 2002). It is, as synthesized by Portes (1998), the ability of actors to secure benefits as a consequence of membership in social networks. As it is built over time, and based on common understanding and conformation to the norms and rules (Ostrom, 1999), social capital facilitates cooperation, enabling social and economic interactions (Costanza and Voinov,

2001). However, it is important to stress that while increasing use of social capital contributes to its accumulation, excess social capital within a group (bonding) can make it more difficult to exchange and enhance social capital between groups (bridging). Social capital disuse, in turn, contributes to its depreciation. Putnam et al. (1993) assert that social capital that is built for one purpose can further contribute to an entirely different purpose, particularly in a case where much trust and commitment has already been accomplished by the group. Ostrom (1999) further points out that, while a group can work well together to accomplish certain objectives, that may not necessarily be the case for an entirely different objective that involves different expectations, authorities, distribution of rewards and costs. Social capital is, in essence, the result of humans and their interaction, requiring resources from physical and human capital, as well as infrastructure for its existence (Boumans et al., 2002). As such, this concept is not an easy thing to see and measure. Furthermore, social capital is difficult to build by means of external intervention and is strongly influenced by national and regional governmental institutions (Ostrom, 1999).

In RUMBA, like in GUMBO, social capital is modeled as the stock of social networks and of rules and norms. The social network stock is built up by inputs of goods and services used towards social capital formation, by conformation to rules and norms, and by the investment in social capital conventions. It is, however, limited by a maximum network ratio, and depreciated by a disintegration rate (Equation 4.48, net change in social network (SCI)). Rules and norms, in turn, are built with increasing conformation building, a factor that is a function of the benefits associated with social networking and that is lost with decreasing conformation (Equation 4.49, net change in rules and norms).

[4.48]

$$d(\text{SOCIAL NETWORK})/d(t) = \text{SC Network Building} - \text{SC Disintegration}$$

where

SC Network Building = Influx of social capital building effort

SC Disintegration = Loss of social capital

[4.49]

$$d(\text{Rules Norms})/d(t) = \text{Conformation Building} - \text{RN Loss}$$

where

SC Conformation Building = Influx of conformation to rules and norms

RN Loss = Loss of rules and norms

4.7.3. Built capital

Built or physical capital refers to the stock of human-made material resources such as buildings, tools, roads, automobiles, computers, clothes, processed food, etc. Physical capital is essentially built by transformation of natural resources in the economic activity, further used to increase production of other goods and services, consumed for human needs or accumulated as wealth. Over time, physical capital becomes degraded or obsolete, consequently turning into waste. In this model, physical capital is formed and accumulated as a result of transformation of natural resources, such as organic matter, water and ore, and depreciated into a stock of waste after their consumption and decay (Equation 4.50, built capital (US\$ 2001)). In turn, the waste produced is absorbed by nature's absorption capacity, according to its assimilation rate (Equation 4.51, waste (T)). When influx of waste is greater than the assimilation rate, there is accumulation of waste which can further affect ecosystems, human economy and human lives.

[4.50]

$$d(\text{BUILT CAPITAL})/d(t) = \text{BC Formation} - \text{BC Dep Waste Prod}$$

where

BC Formation = Influx of investment in built capital

BC Dep Waste Prod = Loss of built capital due to depreciation and waste production

[4.51]

$$d(\text{WASTE})/d(t) = \text{BC Dep Waste Prod} + \text{Waste from Consumption} - \text{Nat Waste Assimilation}$$

where

Waste from consumption = Waste due to consumption of materials

Nat Waste Assimilation = Waste assimilated by nature

4.7.4. Natural capital

Natural capital refers to the stock that yields the flow of natural resources (Daly 1994). A stock of natural capital (e.g. a forest) generates not only a flow of materials (e.g. timber) but also of services (e.g. erosion control). Natural capital consists basically of three major components: renewable resources, non-renewable resources and ecosystem services (Berkes and Folke, 1994). Renewable resources refer to those self-renewing goods that are provided by ecosystems, such as water, wood, fish, etc. Non-renewable resources refer to exhaustible materials such as minerals, fossil fuels, ore, etc, which are extracted from the environment. Non-renewable resources can be further divided into re-usable (e.g. minerals) and non-reusables non-renewables (fossil fuels). Ecosystem services refer to ecological conditions and processes that regulate and provide for human well being (Daily, 1997). Ecosystem services are the actual life-support functions, providing humans with clean air, water and recycling of materials (Fearnside 1997a; Andersen, 1997), as well as an overall healthy and homeostatic planet.

Unlike non-renewable and renewable resources, which represent a *stock* of material at a certain time, ecosystem services represent a *flow* of processes that occurs over time, and that depends on the overall integrity of the physical structure of the ecosystem and of its health. In other words, there is no function (ecosystem service) without structure (renewable and non-renewable resources), and therefore the loss of

structure implies loss of function. Furthermore, while structural properties of an ecosystem (i.e. ore and trees) can be valued, the functional properties (i.e. nutrients cycling) are factors that are not easily valued (Farnworth et al., 1983). In sum, natural capital represents much more than a supply of resources to economic production. As put by Prugh (1999, p. 52) “the primary value of natural capital is life support.”

In RUMBA, non-renewable and renewable resources are simulated in a similar fashion. Demand for energy, organic matter (biomass), water and ore are estimated according to the total amount of goods and services needed in the production of natural, physical, social and human capital, and in knowledge formation. The user of the model determines the rates of need for each of these goods on all land covers in the production of any given capital. The demand for autotrophes (or consumers) is modeled using a similar approach as for the demand for organic matter and for the harvest rates of autotrophes (or consumers). This demand, together with the land use distribution of either autotrophes or consumers further determines the biomass harvest rate of autotrophes or consumers.

Ecosystem services were aggregated and are simulated in RUMBA as explained in the following sections.

4.7.4.1. Soil Formation

In RUMBA, the process of soil formation is closely related to rates of decomposition, thereby accounting for different rates of organic matter accumulation in different biomes (Equation 4.52, Organic Soil Formation ($M T of C yr^{-1}$)). As autotrophs and consumers die, a pool of dead organic matter accumulates and a flux of soil

formation is generated from this pool in each biome as described in the Biosphere sector of the model.

$$\text{Organic Soil Formation} = \text{Dead OM} * \bullet \text{Rate of Soil Humus Formation} \quad [4.52]$$

where
Dead OM = Dead organic matter

4.7.4.2. Gas Regulation

In RUMBA, this ecosystem service is primarily associated with the uptake of carbon from the atmosphere – through flux of atmospheric carbon that is taken up by vegetation growth minus respiratory losses (Equation 4.53, Gas Regulation (MT of C yr⁻¹)).

$$\text{Gas Regulation} = \text{Amazon NEP Carbon Uptake}/1E6 \quad [4.52]$$

where
Amazon NEP Carbon Uptake = Net ecosystem production on all land cover/land uses

4.7.4.3. Climate Regulation

Climate regulation is in RUMBA associated with variations in regional temperature from year to year. A land cover energy pool determines regional average temperature. An inflow of solar radiation to the region, and an outflow of radiation from the region to space, controls this energy pool. The energy pool is in turn affected by the extent of land cover areas and of their albedo capacity (Equation 4.53, Climate regulation MT of C °C⁻¹ yr⁻¹). This service also represents a limit to NPP.

$$\text{Climate Regulation} = 1/(\text{Regional Temperature}/(\text{Total Net Ecosystem Production}*1E3)) \quad [4.53]$$

where

T = Temperature

4.7.4.4. Nutrient Cycling

Nitrogen is used as proxy for all other nutrients such as Phosphorous in RUMBA. Plant nutrient uptake of N serves as a proxy for nutrient cycling. Plant N uptake is represented as an inflow of nutrients into the soil nutrient pool, associated with gross primary production, soil formation and biomass nutrient content of each land cover (Equation 4.54, Nutrient Cycling (MT of N yr⁻¹)).

[4.54]

$$\text{Nutrient Cycling} = \text{Plant N Uptake}/1E6$$

where

Plant N Uptake = Uptake of N by plant biomass as a result of primary production

4.7.4.5. Recreation and Cultural

In RUMBA, recreational and cultural activities are positively related to total biomass amounts and the density of the social network and negatively related to human population stocks. Hence, while the recreational and cultural activities service increases with increasing social network density and biomass, it decreases with increasing population (Equation 4.55, Recreation and Cultural (MT of C SCI⁻¹)).

[4.55]

$$\text{Recreation and Cultural} = \text{IF Social Network} < 1 \text{ OR Total C Biomass} = 0 \text{ THEN } 0 \\ \text{ELSE } ((\bullet \text{Biomass Recreational Value} * (\text{Total C Biomass})/1E6) / \text{Social Network})$$

where

Biomass Recreational Value = Index of recreational value of biomass

Total C Biomass = Amount of biomass per land cover/use

Social Network = stock of social capital

4.7.4.6. Waste Assimilation

In the RUMBA, this is modeled as the natural waste assimilation itself a function of the waste stock and a rate of waste assimilation rate, and the maximum waste assimilation potential of the system (Equation 4.56, Waste Assimilation (MT of C yr⁻¹).

[4.56]

$$\text{Waste Assimilation} = \bullet \text{Max Waste Assimilation Potential} - \text{Nat Waste Assimilation}$$

where

•Max Waste Assimilation Potential = Maximum potential of ecosystem to assimilate waste

Nat Waste Assimilation = Natural waste assimilation ability of ecosystems

4.7.4.7. Disturbance Regulation

Disturbance regulation is measured in RUMBA as the biomes yearly change of total biomass (autotrophs, consumers and decomposers) (Equation 4.57, Disturbance Regulation (MT of C)). The lower the variability in biomass, the greater the disturbance regulation service of the systems.

[4.57]

$$\text{Disturbance Regulation} = \text{IF Total C Biomass} = 0 \text{ THEN } 0 \text{ ELSE Total C Biomass} / 1e6$$

where

Total C Biomass = Total amount of biomass of vegetation of land cover/land uses

4.8. Economic Production and Human Welfare

The RUMBA simulation of ecosystem goods, economic production and human welfare within the Anthroposphere is based on the Cobb-Douglas production function. This function has been widely used by researchers as a general description of aggregate production relationships (Nicholson, 1998) as it allows levels of production output for combination of inputs. As pointed out by Boumans et al. (2002), there are great

advantages to this approach. First, the marginal product of each input is positive and decreasing; this is to say that more input will lead to more output, but each additional unit of input results in less additional output than the previous input. Second, it allows for the substitution of factors of production (inputs). Third, it is mathematically tractable and log linear allowing easy manipulation (Bairam, 1994).

This conventional approach to production may lead to the misguided assumption, common in regular econometric models, that a diminishing natural capital could potentially be substituted by increasing human, social or physical capital (i.e. substitution of factors of production). However, this shortfall is avoided in a dynamic systems model such as RUMBA. In RUMBA natural and manufactured capital are largely complementary, and hence, there can be no economic production without natural capital inputs. In other words, RUMBA was developed with the assumption that natural capital is an essential input to human, social or physical capital and hence, that such capitals can not be produced without natural capital (Boumans et al., 2002). This way, while there may be substitutability of the manufactured capital in the production function, and in generation of economic production and human welfare, the existence of these inputs of production depends on a flow of natural capital (i.e. renewable, non-renewable and ecosystem services) (ibid). Furthermore, internal consistency within the model prevents production of a flow of natural capital in the absence of minimum conditions required for ecosystem production.

In summary, Economic production (economic goods and services) is simulated as the inputs from the manufactured and natural capital, and referred in the model as the GRP – gross regional product. Welfare, on the other hand, is simulated by inputs from the

manufactured and natural capital, together with consumption (non-invested in GRP) and mortality rates coefficients. In the model, welfare is represented by an index of social welfare.

4.8.1. Economic Production

The gross regional economic production (GRP) is modeled as a Cobb-Douglas production function of both natural capital (goods provided by nature, as represented by energy, ore, total organic matter and total water use) and manufactured capital (built capital, knowledge, social network and labor force) (Equation 4.58, GRP (Billion US\$ (2001) yr⁻¹). The exponential factors on each input account for their relative contribution to GRP (Boumans et al., 2002).

[4.58]

$$GRP = BUILT\ CAPITAL^{BC\ Exp} * Knowledge^{Know\ Exp} * Social\ Network^{SC\ Exp} * Labor\ Force^{Labor\ Exp} * Energy^{E\ Exp} * Ore^{Ore\ Exp} * T\ Org\ Matter^{TOM\ Exp} * T\ water^{WaterUse\ Exp}$$

where

Built Capital = Stock of built capital

Knowledge = Stock of knowledge

Labor Force = Stock of labor force

Energy = Available energy for economic production

Ore = Available ore for economic production

T Org Matter = Available organic matter for economic production

T Water = Available water for economic production

Next, goods and services from natural capital, manufactured capital, a factor of total productivity (reflecting technological change), and a productivity reduction (that accounts for the increasing accumulation of waste and diminishing capacity of production) are combined to generate a flow of goods and services economic production (Equation 4.59, GS Econ Prod (Billion US\$ (2001) yr⁻¹). GS Econ Prod represents the

full size of the human economy since it takes into account the contribution of all factors of production, including those of ecosystem services.

[4.59]

$$GS\ Econ\ Prod = EcoServices\ Production * EcoGoods\ Prod * Partial\ GRP * Total\ Factor\ Productivity * Prod\ Reduction$$

where

EcoServices Production = Inflow of ecosystems services contributing to economic production

EcoGoods Prod= Inflow of ecosystem goods contributing to economic production

Partial GRP = Inflow of knowledge, built capital, labor and social capital contributing to economic production

Total Factor Productivity= Index reflecting effect of technological change on increasing economic production

Prod Reduction = Index reflecting effect of waste on reduction of economic production

The annual flow of GS Econ Prod creates the stock of Goods and Services which, in turn, contribute to the formation of knowledge, built capital, social capital, personal consumption and natural capital. The manufactured capital thus created is therefore a function of ecosystem goods and services, as well as of an investment rate defined for each form of capital. By using the contribution of goods and services of the nature to build the manufactured capital, RUMBA ensures an economic production that takes into account the biophysical limits of the planet.

Because RUMBA is a model of a region, its economic sector, unlike that of GUMBO, must account for input and output flows that are characteristic of open economic systems. The inputs and outputs to the region are simulated as imports, exports and flows of outside investments, which are estimated as the net flow of money coming into or leaving the system. These flows, together with flows of interest rates and of a currency devaluation mechanism determine the overall stock of regional debt, as shown on Equation 4.60 (net change on Debt (Billion US\$ (2001) yr⁻¹))

$$d(\text{Debt})/d(t) = \text{Imports} + \text{Interest} + \text{Devaluation \& Valuation} - \text{Exports} - \text{In \& Out Investments}$$

where

Imports = Total volume of inter-regional and international imports to the region

Interest = Effect on debt of interest payments

Devaluation & Valuation = Effect on debt of currency devaluation/valuation

Exports = Total volume of inter-regional and international exports from the region

In & Out Investments = Effect on debt of investment inside the region (from external sources) and outside of the region (from internal sources)

The demand for goods that can not be met by the regional economy, as simulated in the anthroposphere sector, determines the regional volumes of imports. The regional volume of exports, in turn, is determined by the size of overall stock of debt (e.g. exports increase as necessary to make debt payments), the rate of the economic production that directed towards debt payment and by a rate to account for exogenous influences, such as those exerted by external demand for regional products. The economic growth of the region is therefore constrained by its overall trade deficit and by the interest rates that accrue to large debts.

4.8.2. Welfare Production

Welfare production adds to the gross regional product the contribution of welfare derived from ecosystem services for human consumption, health and accumulation of waste. The welfare functions are modeled as individual Cobb-Douglas functions for welfare from human made capital (accounting for the welfare derived from built capital, knowledge and social capital), welfare from ecosystem services, from human consumption (that is not invested in GRP), and from mortality and waste (Equation 4.61, Welfare (Welfare Index)).

*Welfare = Welfare from human made capital * Welfare from EcoS * Welfare term consumption * Welfare term waste * Welfare term Mortality*

where

Welfare from human made capital = Welfare-derived from human made capital

Welfare from EcoS = Welfare-derived from ecosystem services

Welfare term consumption = Welfare-derived from consumption

Welfare term waste = Loss of welfare due to waste

Welfare term Mortality = Loss of welfare due to mortality

The exponential parameters, employed in the estimate of each term individually (i.e. in the calculation of the welfare from ecosystem services), are estimates of aggregate individual preferences (Boumans et al., 2002).

4.8.3. Ecosystem Services Value: Marginal Product

The valuation of ecosystem goods and services in the model is based on marginal product of the ecosystem service in the production function of the model. The value is calculated as the impact of an incremental change in an ecosystem service on total output of the production of goods (Equation 4.62, Price EcoServices (Billion US\$ (2001) yr⁻¹)).

[4.62]

$$Price\ EcoServices = \bullet ES\ Exp * GS\ Econ\ Prod * 1E9 / TECOservices * 1E6$$

where

•ES Exp = Exponential rate of ecosystem service

GS Econ Prod = Goods and Services Economic Production

TECOservices = Total Ecosystem Services produced

4.9. RUMBA Scenarios

Scientists, activists, government officials and policy-makers alike are often confronted with decisions about the future, often relying on mental/static models to anticipate the potential effects of their choices, given a certain set of conditions and assumptions (Bennet et al., 2003). However, mental/static models are fairly limited in

aiding the comprehension of complex systems and, furthermore, in allowing consideration of the inherent uncertainty surrounding future. Dynamic systems models, on the other hand, by integrating different aspects of a system under known conditions, and, furthermore, by enabling the development of a set of alternative future scenarios that may or may not happen (Pettersen et al., 2003), are a viable and crucial tool in assessing interventions in highly unpredictable systems.

At present, much uncertainty and controversy exists regarding the most appropriate or best course of action regarding development and conservation of the Brazilian Amazon. Opposing perceptions and interests often dictate opinions and rationalization of potential costs and benefits of human interventions. In RUMBA, I develop a series of five scenarios to investigate different alternatives for use and protection of resources in the region, and to anticipate the effects of opposing choices.

The first scenario is a base case (baseline), based on historical trends and best fit of important parameters for which data sets were available. The baseline is simulated from 1975 to 2100, and calibrated from 1975 to 2004. The remaining scenarios are based on two variations of parameters regarding policy choices (development versus conservation) arrayed against different assumptions regarding source of funds to implement programs in either policy choice (own resources versus own and external resources combined). These alternative scenarios are simulated from 2005 to 2100. Although this set of choices necessarily represents a simplification of reality with somewhat polarized perceptions for some of the scenarios, I believe that it yields important insights and results that should be considered, even if the way an eventual policy choice is implemented may not be as extreme as any of my scenarios would suggest.

In RUMBA, policies are defined as preferences determining choices (investment rates) regarding the investment of the stock of goods and services produced by the economy of the region in the formation of capitals, consumption and debt payments. A policy geared towards development (exploitation) or protection (conservation) is based on a choice of a higher rate of investment in built capital or natural capital, respectively, relative to the other forms of capital and debt payment. For the purposes of simplification, an assumption is made that consumption rates remain unchanged over time. Since investment in different capitals generates a different demand for goods and services, the choice of investment rates has an important effect on the economic production of the region and on its use of natural resources and availability of ecosystems services, and ultimately on the welfare of local people.

Besides the policies determining the rate of investment, assumptions are built into the scenarios defining whether implementation of such policies are based on the exclusive use of own resources – limited to investment of the region’s stock of goods and services – or based on both own and external resources with the latter being an inflow of investment from outside the system to support implementation of policies. This alternative is essentially based on the assumption that the region will choose to combine efforts to act in one direction or the other (development/conservation), pooling financial resources with the external source toward that goal. Naturally, that may not be entirely the case. The baseline scenario follows historical trends and choices implemented over the last three decades. The alternative futures (Scenarios 1 – 4) – whose brief descriptions are given below are put into place from the year 2005 forward and are determined as a choice of increasing/decreasing rates according to the baseline.

4.9.1. Scenario 1: Exploitation with own resources

In the Exploitation with Own Resources (Scenario 1), a choice is made to increase investment in infrastructure in the region through higher rates of investment of the economic production on built capital, implemented exclusively with regional resources and in detriment to natural, human and social capitals. A higher rate of debt payment is also assumed to balance debt incurred by purchase of external goods. This scenario corresponds to the choice made by the government as well as the private sector of the region (composed of the states of the North Region together with Maranhao and Mato Grosso) to devote most of its resources to building and paving roads and to construction of ports and river canals – projects with the ultimate goal of increasing economic production and development of the region. This scenario is based on the assumption that no outside resources will be available, either because of international or national pressure to limit development in the region, risks associated with large-scale projects in the area, or lack of resources/unwillingness from the federal government or external private sector to implement large-scale projects in the region.

4.9.2. Scenario 2: Exploitation with Own Resources and External Resources

Similarly to Scenario 1, massive investment on built capital is implemented with both regional and external resources. This scenario is intended to assess the effects of mega development projects in the region, such as the recent Brazilian government proposal to expand infrastructure development into the region by implementation of the Avançar Brasil (Forward Brazil) program. This US\$43 billion program, to be implemented between 2001-2007, is estimated to support about US\$ 20 billion worth of infrastructure building, such as road paving, river channeling, port improvements and

expansion of energy production (Peres, 2001; Nepstad et al., 2002; Nepstad et al., 2001; Carvalho, 2001; Peres, 2001; Fearnside and Laurance, 2002; Laurance et al., 2001). The first few years of program (e.g. 2001 – 2003), in particular that associated with the implementation of infrastructure projects, have suffered from the Brazilian economic crisis that began in 2001 (Smeraldie and Carvbalho, 2003) and, as a result, most planned projects in this period were not finished or even started. Other important reasons for delay or cancellation of planned projects were problems associated with project environmental impact assessment and licencing as well as fiscal irregularities (ibid).

4.9.3. Scenario 3: Conservation with Own Resources

This scenario represents a choice by the region to increase protection of natural resources with higher investment in natural, human and social capital in detriment to built capital and debt payment. Potential investments may include enforcement of environmental legislation, with a focus on reduction of deforestation rates and burning of biomass, strengthening of regional governmental capacity, establishment and effective management of protected areas, extensive environmental awareness projects, etc. Higher investments in education and civil society organization are also implemented on this scenario. This represents a choice opposite to that described in Scenario 1.

4.9.4. Scenario 4: Conservation with Own and External Resources

Similar to Scenario 3, in Scenario 4 a substantial investment is made in increasing protection of natural resources with the financial support of both regional and external resources. In this version of the model, rates of external investment were assumed to be at the same level as those from domestic investments of the economic

production. Table 4.7. provides an overview of these scenarios. Choices of parameters for the baseline, as well as the four different scenarios are shown in Table 4.8.

Table 4.6. Overview of the Scenarios Simulated in RUMBA.

Policy Choice Regarding About Development			
		Exploitation	Conservation
Assumption About Economic Resources	Own resources	Scenario 1: Exploitation with own resources	Scenario 3: Conservation with own resources
	Own and external	Scenario 2: Exploitation with own and external resources	Scenario 4 Conservation with own and external resources

Table 4.7. Parameters Used in RUMBA to Determine Policies and Assumptions for the Investments in Formation of Capitals, Consumption and Trade Debt for Baseline and Four Alternative Scenarios of RUMBA

	Baseline	Scenario 1	Scenario 2	Scenario 3	Scenario 4
Human Capital	0.1	0.05	0.1	0.15	0.24
Social Capital	0.02	0.01	0.01	0.03	0.03
Built Capital	0.25	0.40	0.35	0.10	0.05
Natural Capital	0.1	0.05	0.02	0.25	0.18
Consumption	0.45	0.45	0.45	0.45	0.45
Trade Debt	0.03	0.04	0.07	0.02	0.05

Chapter 5. RUMBA Calibration

Assessing the performance of a model depends highly on the purposes and design of the model (Swartzman and Kaluzny, 1987). Generally speaking, the purposes of models range from understanding system behavior to the development of realistic applications used to investigate policy alternatives. While it may be relatively simple to calibrate a model, that is, to compare predictive model outputs with field data – provided that there are enough reliable data sets for such a process – the assessment of models designed to enhance understanding of a system is generally more difficult and complex. Therefore, model calibration is followed by model validation and confirmation. The general controversy in the literature and in science (Rykiel, 1996) regarding these methods requires some definitions and comments on assessing the performance of a model.

Validation, defined by some authors as the “assertment of truth”, is not considered to be consistent with the logic of scientific research, and, hence, some authors argue that it is impossible to validate an ecological simulation model (Reckhow and Chapra, 1983; Swartzman and Kaluzny, 1987; Oreskes et al. 1994). Confirmation – the process of confirming observations – is instead an acceptable procedure since it does not demonstrate the veracity of a model or hypothesis but only supports its probability (Oreskes et al., 1994). Other authors assert that a validated model is one which is acceptable for its intended use because it meets specific performance requirements (Rykiel, 1996). In that sense, validation is certainly possible and often essential for user acceptance, involving a number of tests (ibid). Levins (1966) adds that the validation of a

model is not to be interpreted as the "truth" but that the model generates good testable hypothesis relevant to important problems.

A similar confusion occurs with verification, very often used interchangeably with validation. To differentiate, some authors define verification as a demonstration that the modeling formalism is correct, employing mechanical (i.e. mechanically correct mathematics) and logical (acceptable program logic) approaches (Rykiel, 1996).

In any event, in order to first assess a model, one must necessarily consider 1) the accuracy of the assumptions made in building and running the model, 2) how realistic the overall behavior of the model is, and 3) how sensitive the model is to those assumptions (Swartzman and Kaluzny, 1987). Furthermore, it is important to consider that the effectiveness of a model involves a trade-off between how much the model attempts to explain (articulation) and how well it explains it (accuracy) (Costanza and Sklar, 1985). In an assessment of eighty-seven models, Costanza and Sklar (1985) show that accuracy fell with increasing articulation, explained to be a result of increasing complexity and cost. Effectiveness, on the other hand, rose to a maximum at intermediate articulation and then fell – showing that highly accurate models tended to be low in articulation and highly articulate models tended to be low in accuracy.

Another interesting result from Costanza and Maxwell (1994) relates to the relationship between resolution and predictability. These authors show that while increasing resolution provides more descriptive information about the patterns in data, it also increases the difficulty of accurately modeling those patterns. Hence, the predictability of a model tends to fall with increasing resolution due to compounding uncertainties. Snowling and Kramer (2001) after analyzing a few models concluded that

indeed more complex models are not necessarily better. According to their study, the increased sensitivity of more complex models might outweigh the benefits of the marginally better fits these models give.

It is therefore important to point out that, regardless of the choices made regarding articulation, accuracy and complexity of spatial and time scales, a model is by definition associated with errors and uncertainties (Westervelt, 2001; Snowling and Kramer, 2001). This is mostly due to the limitations in our understanding of complex and dynamic systems, the interactions and feedback loops, the complexity associated with chaotic and catastrophic events and path-dependent behaviors, and the limited availability of data. This is an inherent part of what a model is: a simplification of reality and a tool to solve problems (Jorgensen, 1986). Modeling complex systems requires understanding, synthesizing and integrating processes into mathematical relations, based on numerous assumptions of systems properties and behavior. Not surprisingly, there is always a potential for a number of sources of errors (Westervelt, 2001).

Most commonly applied methods for checking the overall behavior of the model include calibration – manipulation of the independent variables to obtain a match between the observed and simulated distribution or distributions of a dependent variable or variables (Oreskes et al., 1994) – and sensitivity analysis – evaluation of the overall sensitiveness of model output to changes in parameter values (Swartzman and Kaluzny, 1987).

The calibration of RUMBA relied essentially on field data provided by many authors for the different sectors of the model, as described in the section below. A major impediment to more accurate calibration was the lack of historical data (i.e. time series)

for many of the stocks modeled in RUMBA, and in some cases, lack of information on the parameters within the model. Figure 5.1. shows datasets used to calibrated RUMBA. In the following section I explain the assumptions made to gather the datasets used in the calibration or to infer such information whenever datasets were not otherwise available.

5.1. Calibration of the Land Cover/Land Use Sector

Extensive research was done to gather information on the seven land cover/uses modeled in RUMBA. The process proved to be cumbersome, not only because of the scant information on the area of the land uses, but also because the inconsistencies in assumptions and approaches among different authors in their estimation. Common problems were those associated with different definitions of the geographical area, main vegetation types and rates of land use change in the Amazon, as well as with determination of original cover of areas where these changes were or are occurring. Therefore, basic definitions used in the calibration are explained next.

The original forest area of the Brazilian Legal Amazon refers to the approximately 4 million km² originally covered with open and dense forest (dos Santos, 1987; Fearnside, 1996; Fearnside, 1997; Kohlhepp, 2001; Nepstad et al., 2001; Serrao and Homma, 1993; Serrao et al., 1996; Skole and Tucker, 1993). Regions that were originally savannah, aggregated in RUMBA as areas of native grassland and savannah, occupy approximately 800,000 km² (Skole and Tucker, 1993). Seasonally flooded areas (varzea) cover about 70,000 km² (Serrao and Homma, 1993), while rivers cover another 180,000 km² (Skole and Tucker, 1993).

It is extremely difficult to know the exact extent of deforestation across the Brazilian Legal Amazon. Estimations vary tremendously because the calculated rates are often times based on different measurements and criteria (Fearnside, 1993b). Furthermore, they refer exclusively to losses of primary forest within the portion of the region that was originally forest (Fearnside, 1993b; 1997), leaving the savannah absent from any deforestation measurement (Nepstad et al., 1997). Since most of the information on land use is not readily available, many calculations were made to infer the land use areas I used in the calibration of the model, as described below. Currently, the main source of data for land use in the Brazil is the Censo Agropecuario (IBGE, 1975; 1985; 1996). The historical datasets provided by this data are detailed into different categories that had to be aggregated to be used in this study. Table 5.1 summarizes this information, providing a description of the parameter, the range of values found in the literature, the calculation used to derive the parameter (whenever necessary), and the chosen value used to calibrate RUMBA.

For the purpose of RUMBA calibration, the area of remaining forest cover in a given year is calculated as the known originally forest covered area (Skole and Tucker, 1993) minus such areas that are at that point in time used for cropland, pasture, fallow and urban purposes. Areas of cropland and pasture were derived from aggregations of census-tract-level data for all the Legal Amazon states, as provided by the Censo Agropecuario (IBGE, 1975; 1985; 1996). Areas of seasonally flooded forest (*várzea*) and lakes were estimated as open water waters, plus seasonally inundated forest and macrophyte covered areas (Melack and Forsberg, 2001). Areas of river were estimated as the annual flooded area (Richey et al., 2002) minus open waters and floodplain (Melack

and Forsbert, 2001). Remaining areas of savannah were estimated as the originally covered savannah area minus cropland, pasture, fallow and urban areas in the savannah areas. In order to derive the area of human use in the savanna region, we had to make two important assumptions. First, we assumed savanna to be found only in the central Brazilian plateau (Eiten, 1982) in the states of Tocantins, Mato Grosso and Maranhao. Although other savanna patches are found within the Amazon forest region (i.e. the “campo limpo”, “campo sujo”, “campo cerrado”, “cerrado ss”, cerradao and other seasonal savannas and Amazon caatingas) (Coutinho, 1982), lack of information on their extent and human use prevented their inclusion to the calculation of land described in this dissertation. Second, I assumed that the areas farmed in these states above in excess to the state documented deforested area (in the strict sense used by INPE, deforestation refers to areas cleared in forest areas only) occurred in the savannah areas. Since INPE gross deforestation data is only given for year 1978, and then from 1989 until present, I estimated the cleared areas for the years 1975 and 1985 by subtracting the annual mean rates of deforestation for these three states for these two years, using the decade annual means of 1977 to 1988. Third, I assumed that rate of land use for cropland, pasture and fallow in the savannah region of these states were similar to the rate of use in the rest of the state. For instance, if cropland use corresponded to 30% of the human use in the forest area of a certain state, it would also represent 30% of the use in the savanna area of that state. This approach is a reasonable approximation given the lack of information on these land uses mentioned before.

A review of the literature shows that the range of secondary forest areas within the Brazilian Amazon region varies between 30 – 70 percent of that of cleared forest

(Fearnside, 1993b; 1996; 1997a; Hecht, 1993; Houghton et al., 2000; Mattos and Uhl, 1994; Moran et al., 1994; Nepstad et al., 1997; Skole et al., 1994; Schroeder and Winjum, 1995a). For RUMBA I estimated the regrowth forest (i.e. the fallow areas in originally covered areas) by using agriculture census data (IBGE, 1975; 1985; 1996) in a similar manner to other land uses. Finally, no information was found on the urban use of land. Therefore, I inferred this information calculating the number of residences across the region, as provided by IBGE census data (1996), and an estimated average size occupied by residences and public areas (Portela, 2002).

Table 5.1. Parameters/Datasets Used in the Calibration of the Land Use Sector.

Parameter	Definition	Range (km ²)	Chosen value (km ²)
Brazilian Legal Amazon	Brazilian North region and parts of Mato Grosso and Maranhao	5,000,000 - 5,139,925 ¹	5,032,925 ²
Original Forest Cover	Areas originally covered with dense and open forest.	3,303,000 - 4,148,000 ³	4,092,831 ⁴
Forest	Remaining area of primary forest after land use conversion to other uses	N/A	Time series from 1975 – 1995/96 ⁵
Original Savannah	Areas originally covered with dry, scrub vegetation and native pasture (southern portion of the Amazon).	692,141 - 847,400 ⁶	847,400 ⁷
Savannah	Remaining areas of savannah not converted to crops and pasture.	N/A	Time series from 1975 – 1995/96 ⁸
Flooded Forest	Seasonally flooded areas and lakes, including open water and vegetated area	N/A	67,900 ⁹
Rivers	Water running on the Amazon River mainstem and its tributaries	79,000 – 290,000 ¹⁰	182,100 ¹¹
Cropland in forest	Annual and perennial cropland areas in the originally forest covered areas	N/A	Time series from 1975 – 1995/96 ¹²
Pasture in forest	Open native and planted pasture in the originally forest covered areas	N/A	Time series from 1975 – 1995/96 ¹³
Cropland in savanna	Annual and perennial cropland areas in the originally savannah covered areas	N/A	Time series from 1975 – 1995/96 ¹⁴
Pasture in savanna	Open native and planted pasture areas in the originally savannah covered areas	N/A	Time series from 1975 – 1995/96 ¹⁵
Fallow in Forest	Fallow and productive but not used areas in the originally forested covered areas	N/A	Time series from 1975 – 1995/96 ¹⁶

...Table 5.1. Continued.

Parameter	Definition	Range (km ²)	Chosen value (km ²)
Fallow in savanna	Fallow and productive but not used areas in the originally savannah covered areas	N/A	Time series from 1975 – 1995/96 ¹⁷
Urban in forest	Nuclei of settlement areas that provides urban functions for its population in previously forest areas	N/A	Data from 1970 –1990 ¹⁸
Urban in savanna	Nuclei of settlement areas that provides urban functions for its population in previously savanna areas	N/A	Data from 1970 –1990 ¹⁹

¹ Chomitz (2001), Fearnside (1993, 1996), INPE (2002), Pfaff (1999), Serrao and Homma (1993), Skole and Tucker (1993).

² Skole and Tucker (1993).

³ dos Santos (1987), Fearnside (1996, 1997b), Kohlhepp (2001), Nepstad et al. (2001), Serrao and Homma (1993), Serrao et al. (1996), Skole and Tucker (1993).

⁴ Skole and Tucker (1993).

⁵ Calculated as original cover forest minus areas of cropland, pasture, fallow and urban uses. Please see footnote 14 for details on land uses estimations.

⁶ Fearnside (1993, 1997), Serrao and Homma (1993), Skole and Tucker (1993).

⁷ Skole and Tucker (1993).

⁸ Calculated as area of original savannah minus crops occurring in savannah and pasture occurring in savannah. Please see footnote 14 for details on land uses estimations.

⁹ Melack and Forsberg (2001).

¹⁰ Melack and Forsberg (2001) and Richey et al. (2002).

¹¹ Calculated as the difference between the total annual mean flooded area (Richey et al., 2002) and the average maximum seasonally flooded open water and vegetated areas (Melack and Forsberg, 2001).

¹² See footnote 14.

¹³ See footnote 14.

¹⁴ Calculated as percentage of areas of cropland that occurring in areas originally covered with savannah in the states of Tocantins, Mato Grosso and Maranhao. This ratio was derived by estimating the difference between the combined area for cropland, pasture and fallow (IBGE, 1975; 1986; 1996) minus area deforested in 1975, 1985 and 1995 (INPE 2002) for each of those states. Deforested areas for the years 1975 and 1985 were estimated based on INPE gross deforestation extent for year 1978 and 1989, by subtracting annual mean rates of deforestation for the states using the decade annual means of 1977/1988. The area that surpass the deforested areas according to INPE was then multiplied by the overall rate of crop in relation to the total area of crop, pasture and fallow in the region. The area of cropland (or pasture or fallow) in the forested areas of Amazon is the difference between the total area of cropland (or pasture or fallow) and the areas of cropland (or pasture or fallow) estimated to be in the savanna region. This calculation assumes that 1) savanna only occurs in the states above mentioned; w) the ratio of use for crop in the savannah region is similar to that of the entire region; 2) areas farmed beyond deforested regions (i.e. in the strict sense used by INPE) occur exclusively in the savannah areas. Values presented in Table 5.2. Data for the state of Tocantins was only available for the periodo 1985 and 1995.

¹⁵ Similar to the calculation above for pasture areas.

¹⁶ The difference between the area that surpass the deforested areas according to INPE and the areas of cropland and pasture in the forested region.

¹⁷ See footnote 14.

¹⁸ Calculated as number of residences IBGE (1996) times average parcel of land plot in urban areas (360m²) times a factor to account for public areas (5) (Portela 2002). Residences in the state of Tocantins, Mato Grosso and Maranhao were considered to be on the savanna region. The residence datasets were from 1970, 1980 and 1990 were interpolated to get data for 1975, 1985, 1995.

¹⁹ See footnote 18.

Table 5.2. Area Values Used in the Calibration of the Land Cover/Land Use (km²) Sector^a

Forest	F Natural Ecosystem	F Cropland	F Pasture	F Fallow	F Urban	TOTAL
Forest						
1975	3,846,787.05	13,704.70	37,817.28	36,842.68	373.29	3,935,525.00
1985	3,511,478.70	62,027.08	148,809.54	212,426.77	782.92	3,935,525.00
1995	3,542,188.02	55,225.50	228,320.55	108,076.23	1,714.70	3,935,525.00
Savanna						
1975	659,637.12	14,860.94	110,430.00	62,107.14	364.71	847,400.00
1985	539,603.32	23,718.25	231,497.46	52,065.85	515.12	847,400.00
1995	567,932.59	19,151.64	234,637.30	24,619.551	1,058.92	847,400.00

^aValues calculated based on IBGE (1975, 1985, 1996) and INPE 2002

Assumption: Areas of land use in savannah correspond to areas of land use not accounted by INPE as deforested areas (i.e. areas of pristine forest cleared for land use). Such areas were then proportioned among crops, pasture and fallow, according to overall proportion of these land uses in the state area, as explained in Footnote 14 of Table 5.1.

5.2. Calibration of the Biosphere Sector

In RUMBA, the productivity of autotrophs is the basis of many ecosystem services and a key to the results of the model. Therefore, the calibration of the biosphere sector was based on the average values of net primary production of the land cover/land uses found in the literature. The net primary productivity of tropical rainforests is the highest among the most productive terrestrial ecosystems in the world, with an annual mean of many areas estimated as about 1,000 to 3,500 T km² yr⁻¹ (Jordan, 1985). The value chosen for RUMBA forest cover was 1,560 T km² yr⁻¹ (Malhi et al, 1999), consistent with the overall mean of 1170 T km² yr⁻¹ found in a simulation model of net primary productivity of tropical forest in South America (Raich et al., 1991). NPP values of the other land covers/land uses used to calibrate RUMBA are displayed on Table 5.3.

Table 5.3. Total Annual Net Primary Productivity (NPP) Used in Calibration of the Biosphere Sector (T km² yr⁻¹)

Land Cover/ Land Use	Range	Chosen value
Forest/Natural ecosystem	1000 – 3,500 ^a	1,560 ^e
Cropland	100 – 4,000 ^a	650 ^a
Pasture	200–2,000 ^a	700 ^a
Forest Fallow	1,000 – 5,500 ^b	1,500
Savanna	240 – 570 ^c	500 ^b
Flooded forest	800 – 4,000 ^a	1,665 ^f
Rivers	100 – 1,500 ^a	45 ^g
Urban	80 – 190 ^d	110 ^d

a. Lieth (1975).

b. Houghton et al. (2000).

c. Medina (1980).

d. Sharp (1975).

e. Malhi et al. (1999).

f. Calculated by author based on Melack and Forsberg (2001) total net productivity of phytoplankton, macrophytes, peryphyton and flooded forest (113 Tg C/yr) on the total area of flooded forest and lakes.

g. Calculated by author based on Wissmar et al. (1981) and Melack and Forsberg (2001).

5.3. Calibration of the Lithosphere Sector

High spatial variability of soil carbon and nutrients, within and across different soil types and vegetations in the region, as well as the limited and unreliable estimations available present a limitation to the model. Aggregate numbers, however, provide an overall picture and are important in understanding the effects of deforestation and different patterns of land use change. A study by Moraes et al. (1995) reports on the stocks of C and N on 1162 soil profiles of the 5,000,000 km² area of Legal Amazon basin, using the RADAMBRASIL survey and a digitalized soil map. According to this study, soil C density in the 100-cm depth across the area varied from 2.3 to 21.7 kg C m⁻². The soil C range among the three main soil types (comprising 60% of the total area) was 8.5 to 10.5 kg C m⁻². The mean basin soil C density for the entire area was 10.3 kg C m⁻². The reported range of N soil varied across the basin from 0.25 to 2.3 kg N m⁻². The variation of N content among the three main soil types was much less than of C, ranging from 0.71 to 1.02 kg N m⁻². The C/N mass ratio across the region ranged from 5.9 to 20.6 (ibid). Overall, 45% of the total basin soils C and 41% of total soil N were present in the top 20 cm of the soil profile. According to this study, up to 25% of N remained in the soil after conversion to cropland and about 21% after land was converted to pasture in the initial 2-years after clearing. Soil C density in 8 year old pasture appeared to be on the same level as in original forest (Moraes et al., 1995).

A review of over 100 studies in the Amazon over the past 40 years on nutrient dynamics in forest and other derived land uses (McGrath et al., 2001) provides means C and N content as well as C/N ratios. These values, shown in Table 5.4, are used in the calibration of RUMBA because they account for land uses and intensity depicted in the

model. Like other studies, McGrath et al. (2001) also shows that the largest elemental stocks of the system were found in the top 20 cm of soil. They also show that the C and N storages in the upper horizons are most subject to changes associated with land use. Furthermore, it shows that although the concentration or content of total C and N did not appear to change greatly as a result of forest-to-pasture conversion, C and N storage in younger pastures were significantly higher than in older pasture. More importantly, pasture soils had a higher total C and N concentration than other land uses such as cropping and secondary forest. The low concentration of C and N in crops soils persisted in secondary forest derived from abandoned crops.

Table 5.4. Soil Carbon and Nitrogen Content Values Used in Calibration of the Lithosphere Sector (T km⁻²).

Land Cover/ Land Use	Carbon in the Soil (0- 20cm)	Nitrogen in the Soil (0-20cm)	C/N
Forest/Natural ecosystem	2220	180	12.33
Cropland in forest	-	150	
Pasture in forest	2660	238	11.18
Fallow in forest	2050	160	12.81

All values from McGrath et al. 2001

McGrath et al.'s (2001) study, discussing soil properties under different land uses, proposes three alternative hypothesis for soil C and N: a) Soil C and N decline following forest-to-pasture conversion; b) soil C and N increase in secondary forest with time since abandonment; c) soil C and N under all forest-derived use remain the same. The range of research outcomes providing evidence for alternative hypothesis on C and N soil content under different land uses (Nye and Greenland, 1964; Ayanaba, 1976; Fearnside, 1980; Houghton et al, 1983b; Allen, 1985; Brown and Lugo, 1990; Eden et al, 1990; Reiners et

al, 1994; Werner, 1984; Moraes et al., 1996; Neil et al., 1997; Hughes et al, 1999; McGrath et al, 2000; McGrath et al.'s, 2001) demonstrates the lack of consensus and uncertainties surrounding soil chemical properties following human-induced land use changes (Portela and Rademacher, 2001). Whether C and N soil contents decline or not, there is sufficient evidence that post-clearing treatment and land management play a major role in determining the degree of soil degradation in the long-term (Allen, 1985; Eden et al, 1990; Moraes et al, 1996; Neil et al., 1997; McGrath et al, 2001). In the model RUMBA C and N storage decrease as a result of land use changes from forest to cropland and pasture; that storage may be either be exhausted with soil degradation, return to original conditions, or even increase for pasture and pasture-derived secondary forest growth.

Majority of sediments transported by the Amazon River derives from weathering of Andean Cordillera (Martinelli et al., 1989; Richey et al., 1991; Mortatti et and Probst, 2003), although there is evidence that land use changes across the basin are contributing to the soil losses and leaching of nutrients and to the increasing sediment loads in the rivers (Williams and Melack, 1997; Williams et al, 1997; Brandt 1988; Farella et al., 2001; McLain and Elsenbeer, 2001). A major impediment to determining whether sediment export has increased with development, however, is the lack of historical data on river sediment loads throughout the basin (Forsberg et al., 1989).

CAMREX project (1982-1984) data on the water geochemistry of the Amazon River and its main tributaries was used to inform the calibration of the erosion processes in the Amazon basin. The data are summarized on Table 5.5. These numbers show that while the average sediment flux (TSS) at Vargem Grande was only half of that observed

at Obidos, the average water discharged tripled from Vargem Grande to Obidos, which is consistent with dilution of sediments by poor-nutrient water of the downstream tributaries of the main Amazon channel. Similarly, an increase of nearly 50 percent in the dissolved sediments from Vargem Grande to Obidos river stations was found.

Table 5.5. Erosion Balance of the Amazon and its Main Tributaries Used in the calibration of the Lithosphere Sector.

River Basin	Q	TSS (10 ⁶ T/yr)	TDS (10 ⁶ T/yr)	Mechanical Erosion (T/km ² /yr)	Chemical Erosion (T/km ² /yr)
Varzea Grande Tributaries	47.9 ^a	579.4 ^b	103.2 ^b	510.7 ^b	91.0 ^b
Obidos	159 ^a	1140 ^b	148.9 ^b	246.9 ^b	32.2 ^b

^a Martinelli et al. (1989).

^b Mortatti and Probst. (2003)

^c Estimadated by author based on Mortatti and Probst. (2003)

Values of mechanical and chemical erosion calculated as the amounts of suspended and dissolved sediments of the whole basins show the relevance of the Andean contribution, as well as the importance of the solid transports in relation to the particulate riverine transports. Indeed, the Amazon River suspended sediment, discharged to the ocean at the river mouth, represents 8-10% of the global riverine fluxes (Mortatti and Probst, 2003). The value of mechanical erosion for Obidos (246 MT km⁻² yr⁻¹) is more than two times higher than the values documented by Salati and Vose (1984) (116 MT km⁻² yr⁻¹). This value is also significantly higher than the one obtained by Barbosa and Fearnside (2000) for a primary forest area in Roraima (15 MT km⁻² yr⁻¹). This apparent discrepancy is explained by two factors: 1) the result of more accurate measurements

provided by the CAMREX project; 2) the effects of Andean erosion contribution and of land uses other than pristine forest on the overall rates of the Amazon River water.

5.4. Calibration of the Hydrosphere Sector

The complexity of spatial and temporal patterns of precipitation across the Brazilian Amazon and the variability of soil properties and their topographic patterns represented an important limitation to the modeling of the hydrological cycle of the Brazilian Amazon. Furthermore, the impacts of simplification and aggregation of such processes are but compounded by the lack of historical datasets and reliable estimations of many of the parameters used in the model. Such lack of reliable data was found for, among other things, vegetation evapotranspiration properties and the estimated volume of water storages within the region. However, simplified and data limited models designed by Salati and Marques (1984), Salati and Vose (1984), Salati (1987) and Salati and Nobre (1991) have been extremely important in giving an overview of the region, pointing out the overall trends in precipitation, evapotranspiration and water discharge and the potential effects of deforestation. Such values, aligned with the design and assumptions made in RUMBA are therefore used in the calibration of the hydrosphere sector. The fluxes of water in all land cover/uses of RUMBA were added to represent total fluxes within the region.

Values for annual water balance averages for the Amazon region by Marques et al. (1980) showed precipitation as 2,328 mm, evapotranspiration as 1260 mm (54%) and runoff as 1,068 mm (46%) (Table 5.10). Using these numbers for the entire region, Salati

and Marques (1984) showed that the Amazon discharges $5.44 \text{ E}12 \text{ m}^3 \text{ yr}^{-1}$ into the Atlantic Ocean. RUMBA calibration of the runoff to ocean followed this estimate.

As shown in Table 5.6, the calibration of carbon in surface waters followed average numbers provided by Moreira-Turcq et al. (2003) for TOC discharge near the ocean (Obidos) and those of a mass balance of the DIC budget provided by Devol et al. (1987). Important inflows and inputs of DIC are those from Andean waters (Vargem Grande), tributaries, and respiration within the river. Major outflows of DIC, in turn, are the outflows near the Atlantic ocean (Obidos) and evasion of gases from the river waters. These inflows/outflows are shown in Table 5.6b. Although bicarbonate and carbon dioxide values are aggregated in RUMBA as DIC, I chose to display the overall contribution of the inflows/outflows to DIC, as provided by Devol et al. (1987), in order to point out some important trends in DIC composition in the Amazon River waters.

The single largest input of DIC in the river is that of bicarbonate (HCO_3^-) at about $1.89 \text{ E}7 \text{ T yr}^{-1}$, followed by respiration (CO_2) at about 1.48 T yr^{-1} (respiration is the largest single input of CO_2). Total DIC inputs from tributaries are estimated as $1.63 \text{ E}7 \text{ T yr}^{-1}$. Respiration input is similar to that of bicarbonate, as well as that of total DIC from tributary sources, accounting for about 30% of the total incoming DIC. The largest loss of DIC is also that of bicarbonate, which is discharged into the Atlantic ocean at about $2.91 \text{ E}7 \text{ T yr}^{-1}$. However, bicarbonate inputs from Andes and tributaries ($2.70 \text{ E}7 \text{ T yr}^{-1}$) are in balance with bicarbonate outputs discharge into the ocean ($2.91 \text{ E}7 \text{ T yr}^{-1}$). Evasion of CO_2 , estimated given a boundary layer of $50 \mu\text{m}$, is the next largest loss, estimated as $1.42 \text{ E}7 \text{ T yr}^{-1}$. Note that CO_2 evasion alone is larger than the fluvial input from both Andean sources and tributaries or fluvial output discharging into the Atlantic ocean

(Obidos). Overall, because that total DIC inputs from fluvial sources ($3.70 \text{ E7 T yr}^{-1}$) are nearly in balance with outputs ($4.02 \text{ E7 T yr}^{-1}$), it becomes evident that CO_2 is a major component of the DIC budget (Devol et al, 1987). Devol et al. (1987) argue that given any water free to exchange gases with the atmosphere, respiration will increase the pCO_2 [pCO_2] of the water until CO_2 loss to the air equals CO_2 respiration in a steady-state approach.

Table 5.6a. Carbon (TOC and DIC) Values Used in Calibration of the Biosphere and Hydrosphere Sectors (T yr^{-1}).

	Output	TOC	DIC
Amazon River			
Spatial Exchange Fluxes ⁵			
	Discharge to ocean (Obidos)	$3.27\text{E}+07^{\text{a}}$	$4.02\text{E}+07^{\text{b}}$

a. Moreira-Turcq et al. (2003)

b. Devol et al. (1987).

Measurements of the dynamics of nitrogen are very scarce, and, as a result, patterns of nitrogen losses are difficult to identify. RUMBA calibration of the dissolved inorganic nitrogen (DIN) in surface waters of the hydrosphere follows yield values of DIN provided by Lewis Jr. et al. (1999), as shown in Table 5.8. According to these authors, total yield of nitrogen from Amazon River is about $0.6 \text{ T N km}^{-2} \text{ yr}^{-1}$ (Table 5.8), which is consistent with Salati et al's mass balance numbers (Salati et al, 1982).

⁵C Spatial exchange refer to C fluxes from inputs from Andean sources, runoff and discharge to the ocean.

Table 5.7b. Carbon (DIC) values used in calibration of the Hydrosphere sector (T yr⁻¹).

Input/ Output	pCO ₂	HCO ₃ ⁻	DIC
Amazon River and Tributaries			
Spatial Exchange Fluxes			-
Inputs from upstream (Andean sources)	1.82E+06	1.89E+07	2.07E+07
Inputs from tributaries	7.76E+06	8.52E+07	1.63E+07
Inputs from floodplain			-
Discharge to ocean (Obidos)	1.11E+07	2.91E+07	4.02E+07
Biosphere Exchange			
Respiration (CO ₂)	1.48E+07	-	1.48E+07
Atmospheric Exchange			
Evasion (CO ₂)	1.42E+07	-	1.42E+07

Total values for the Amazon River calculated by author based on Devol et al. (1987).

DIN discharge yields near the Atlantic ocean (Obidos) corresponds to rates of 0.17 T N km⁻² yr⁻¹ of NO₃-N and 0.02 T N km⁻² yr⁻¹ of NH₄-N for the entire Amazon (ibid). Bulk DIN discharge, therefore, is estimated at 9.60 E+05 T yr⁻¹ (Table 5.9).

5.5. Calibration of the Atmosphere Sector

As the atmosphere sector of RUMBA integrates the processes occurring in the spheres and across the land cover/land uses in the Amazon area, an ideal approach to understanding and calibrating exchanges with the atmosphere is estimate the mass balances of water, carbon and nitrogen for the entire region. In this section, I briefly summarize and present some of the information used in the calibration of the atmosphere following this approach.

5.5.1. Carbon Balance

Due to the difficulties associated with measurements and estimation, much uncertainty remains regarding carbon fluxes from tropical forests worldwide (DeFries et al., 2002) and from the Brazilian Amazon in particular (Prentice and Lloyd, 1998; Houghton et al., 2000). Furthermore, few studies combine regional effects of both uptake by forest and of anthropogenic release from deforestation. Table 5.12 summarizes recent studies investigating carbon uptake, release and net balance within the region. The accounting framework adopted for each study is also documented. For instance, most studies adopt the annual balance estimate, which refers to the emissions and uptake on a single year over the landscape in question. Net committed emissions, on the other hand,

Table 5.7. Nitrogen Discharge in Amazon River (T Km⁻² yr⁻¹)^a.

	NO ₃ -N	NH ₄ -N	DIN	DON	TDN	PN	TN
Amazon River							
Spatial Exchange Fluxes							
Discharge to ocean (Obidos)	0.168 (27.7)	0.024 (4.0)	0.192 (31.7)	0.194 (32.0)	0.386 (63.7)	0.242 (40)	0.606

a. Lewis Jr. et al. (1999). Values in parenthesis represent percentage of total nitrogen.

Table 5.8. Nitrogen Value Used in Calibration of the Hydrosphere sector (T yr⁻¹)^a.

Output	NO ₃ -N	NH ₄ -N	DIN
Amazon River			
Spatial Exchange Fluxes			
Discharge to ocean (Obidos)	8.40E+05	1.20E+05	9.60E+05 ^a

a. Calculated by author based on Lewis Jr. et al. (1999).

refer to the long-term emissions and uptakes of a deforested patch, calculated only for the cleared area of a given year (Cattaneo, 2002). As previously explained, carbon uptake refers exclusively to the annual carbon storage or loss of the natural ecosystem (i.e. forest) or the net ecosystem production (NEP). Release refers to the anthropogenic disturbance and related CO₂ emissions. The net balance refers to the difference between the uptake and the release.

Most studies of Amazonian natural ecosystems show this forest as an important carbon sink, with an overall NEP estimated as 0.5 Pg C yr⁻¹ (Grace et al, 1995; Phillips et al. 1998a, 1998b; Prentice and Lloyd, 1998; Nobre and Nobre 2002), although Andreae et al (2002) estimated NEP at about 2.0 Pg C yr⁻¹. However, according to some authors when climatic variability (Tian et al, 1998) or current anthropogenic sources due do deforestation, logging and burning are considered, the net carbon of such forest is considered to be most likely in balance or to represent a net release of carbon to the atmosphere. As a general rule, the methods employed in measurement of the carbon uptake ability of forest ecosystems, as well as in the assessment of their results seem to play an important role in the overall findings. For instance, tower measurements across the Amazon (LBA, 2001) have shown that the forest could be either a small source of carbon to the atmosphere or a large sink, depending on how the data are assessed (LBA, 2003a). Results of few aerial observations of the vertical and temporal distribution of CO₂ in the upper low atmosphere, albeit uncertain, show equilibrium in terms of uptake and release (Nobre, 2002; Nobre and Nobre, 2002; LBA 2003a).

Table 5.9. Carbon Balance values Used in the calibration of the Atmosphere Sector

Reference	Estimate of Uptake (Pg C yr ⁻¹)	Estimate of Release (Pg C yr ⁻¹)	Net Balance (Pg C yr ⁻¹)	Method	Note
Schroeder and Winjun (1995b)	0.10	0.331	- 0.23 (Source)	Conceptual model of ecosystem C storage and flux	Estimations made for the entire country of Brazil
Grace et al. (1995)	0.56		Sink	Process-based model fitted with measurements of CO ₂ flux over undisturbed forest during wet and dry seasons	Estimations made for the Amazon Basin (5.0 E 6 km ²)
Phillips et al. (1998a, 1998b)	0.44 ± 0.26	–	Sink	Annual aboveground biomass change in Amazonian forests	Estimations made for the lowland Amazonian forests (7.1 E 6 km ²)
Fearnside (1997b)	–	0.261	–	Net committed emissions for 1990	Estimations made for the Brazilian Legal Amazon (5.0 E 6 km ²)
Tian et al. (1998)	-0.2 (El Nino years)/ + 0.7 (Non-El Nino years)	0.3	Sink/Source	TEM – Terrestrial Ecosystem Model capturing the interannual climate variability on C storage	Estimations made for the Amazonian Basin

Table 5.9...Continued

Reference	Estimate of Uptake(Pg C yr ⁻¹)	Estimate of Release (Pg C yr ⁻¹)	Net Balance (Pg C yr ⁻¹)	Method	Note
Prentice and Lloyd (1998)	0.2	-	Sink	Review of other studies	
Houghton et al. (2000)	-	0.1 ± 0.4 (Average annual source of 0.18 over 1989 – 1998)	± 0.2 interannual variability (In Balance)	Bookkeeping model tracking the annual emission and uptake of C	Estimations made for the Brazilian Legal Amazon
Malhi and Grace (2000)	2.0	2.4	0.4 (Source)	Net C budget by photosynthesis, autotrophic and heterotrophic respiration	Estimations made for all tropical forests
Nobre and Nobre (2002)	0 – 0.5	-	Sink	Net C budget by photosynthesis, autotrophic and heterotrophic respiration	Synthesis for Amazon forest carbon budget, net balance sink 1 – 7 t C ha ⁻¹ yr ⁻¹

Table 5.9...Continued

Reference	Estimate of Uptake (Pg C yr ⁻¹)	Estimate of Release (Pg C yr ⁻¹)	Net Balance (Pg C yr ⁻¹)	Method	Note
Andreae et al. (2002)	1.5	0.3	1.2	Eddy covariance data	Estimations made from measurement in three forest sites in Brazilian Legal Amazon
Saleska et al. (2003) ^a	–	0.5	Source	Eddy covariance data	Estimations made from measurement in two forest sites in Brazilian Legal Amazon

a. Calculation by author based on carbon loss of 1.3 Mg C/ha/yr and a forest area of 4.3E6 km²

Grace et al. (1995) study of carbon uptake by an undisturbed forest in the Amazon shows that photosynthetic gains of CO₂ exceed respiratory losses throughout the year, with a potential gain of about 1 T ha⁻¹ yr⁻¹. Vegetation growth and mortality studies on monitoring plots across the Amazon by Phillips et al. (1998a, 1998b) show a similar net uptake of about 1 T ha⁻¹ yr⁻¹. Criticism exists that Phillips's studies omit the losses from dead organic material which might compensate for the estimated net gain (LBA, 2003a). There is also some criticism regarding the variation in methods of plot measurements across such studies, and the resulting uncertainties associated with their aggregation (Clark, 2002). A synthesis of Amazonian forest carbon measurements based on forest inventory (Phillips, 1998a; 1998b) as well as CO₂ fluxes shows a gain (uptake minus release) that varies from 1-7 T ha⁻¹ yr⁻¹ in the form of plant biomass kept in the forest (Nobre, 2002; Nobre and Nobre, 2002).

According to Schroeder and Winjun (1995a), Brazilian Amazon is the largest carbon pool, the largest uptake from growth of secondary forest, as well as the largest source of carbon release in Brazil. These authors estimated the 1990 total net annual anthropogenic carbon emission from land use changes for the entire country to range from 174 – 233 MT in 1990, which was equivalent to 2.5-3.3% of the net annual global emissions from all sources that year (Schroeder and Winjun, 1995b). Fearnside (1997b) estimates the anthropogenic release of the Brazilian Amazon to be about 0.26 Pg C yr⁻¹, which makes the Brazilian Amazonia the largest single contributor to the deforestation component of GHG emissions (Fearnside and Guimaraes, 1996). Houghton et al. (2000), using a bookkeeping model to track annual flux of carbon from deforestation, abandonment, logging and fires, showed the emissions to range from 0.1 – 0.4 Pg C yr⁻¹.

They concluded that the releases from such uses are equivalent to the calculated sink effect of the forest and that the flux of carbon between the Brazilian Amazon and the atmosphere may be close to zero.

Indeed, the role of the Brazilian Amazon as a source or sink of carbon is very controversial, and one that requires detailed investigation (Rohter, 2003). This issue has become increasingly contentious with recent studies of CO₂ emissions from the large areas of rivers and flooded forest within the Amazon, pointing to much larger carbon emissions than previously assumed as a result of the carbon partial pressure in the water and in the atmosphere (Richey et al, 2002; Nobre and Nobre, 2002). Overall, there are more studies pointing to the region as a carbon sink (Grace et al, 1995; Phillips et al, 1998a; 1998b; Tiam et al, 1998; Malhi and Grace, 2000; Nobre and Nobre, 2002) than to it being neutral (Houghton et al, 2000) or a source (Schroeder and Winjun, 2002). Assuming the average numbers for uptake to be around 0.5 Pg C yr⁻¹, and release to be around 0.2 Pg C yr⁻¹, it is conceivable that the 1990 carbon balance for the region was an overall sink of 0.3 Pg C yr⁻¹. These are the numbers used in the calibration of RUMBA.

5.5.2. Water Balance

A study on the water balance for the Amazon region by Marques et al. (1980) estimated precipitation to be about 2.32 m yr⁻¹, while evapotranspiration and runoff were estimated at 1.26 m yr⁻¹ (54.2%) and 1.07 m yr⁻¹ (45.8%), respectively. Using these numbers for the entire region, Salati and Marques (1984) showed that the Amazon receives 11.87 E12 m³ yr⁻¹ of precipitated water, returns 6.43 E12 m³ yr⁻¹ to the atmosphere as evapotranspiration, and discharges 5.44 E12 m³ yr⁻¹ into the Atlantic Ocean (Table 5.11). As these numbers show, total precipitation in the Brazilian Amazon

is as much the result of meteorological factors, as it is of the forest's ability to recycle water through evapotranspiration. Indeed, the Amazon region precipitation is composed of inflowing moisture from the oceans (46%), as well as of the water vapor recycling within the Amazon (54%) which accounts for half of the precipitation in the region (Salati and Marques, 1984).

Table 5.10. Water Mass Balance Values Used in the Calibration of the Atmosphere Sector ($E12 \text{ m}^3 \text{ yr}^{-1}$).

	Amazon Region	Percentage (%)
Inflows		
Precipitation	11.87	100.0
Outflows		
Evapotranspiration	6.43	54.2
Continental runoff	5.44	45.8

Salati and Marques (1984)

5.5.3. Nitrogen Balance

Salati et al. (1982) built a mass balance for nitrogen, based on the regional gains and losses of this nutrient across the basin. According to these authors, about $0.6 \text{ T N km}^{-2} \text{ yr}^{-1}$ enter the forest via precipitation and a similar amount is lost via the Amazon River. Root-associated nitrogen fixation are for oxisols soils (50% of the Amazon soils) about $0.2 \text{ T N km}^{-2} \text{ yr}^{-1}$, about $2.0 \text{ T N km}^{-2} \text{ yr}^{-1}$ for ultisols (45% the Amazon soils) and about $20.0 \text{ T N km}^{-2} \text{ yr}^{-1}$ for the fertile soil of the seasonally inundated flooded areas (remaining 5% of the of the Amazon soils). Averaging this for the entire Amazon provides a nitrogen input of about $2.0 \text{ T N km}^{-2} \text{ yr}^{-1}$ (ibid). Using these numbers for the entire basin area of $6 \text{ E}+06 \text{ km}^2$, and following the nutrient retention hypothesis

(Vitousek and Reiners, 1975) results in inputs of about $36 \text{ E}+05 \text{ T N yr}^{-1}$ (bulk deposition) and 120 T N yr^{-1} (nitrogen biological fixation). Outputs (river discharge) are about $36 \text{ E}+05 \text{ T N yr}^{-1}$ and losses via denitrification/volatization are estimated as 120 T N yr^{-1} (Table 5.12).

Table 5.11. Nitrogen Mass Balance Values used in the Calibration of the Atmosphere Sector ($\text{E}8 \text{ T of N yr}^{-1}$).

Nitrogen	Amazon Region	Percentage (%)
Inflows		
Nitrogen Deposition	36	23.1
Nitrogen Fixation	120	76.9
Outflows		
Nitrogen Discharge into the Ocean	36	23.1
Denitrification	120	76.9

Salati and Marques (1984).

5.5.4. Temperature

There are few studies describing average annual surface temperature or measured maximum and minimum values found on the different land cover/uses of the Brazilian Amazon (as described in the present model). Table 5.13 provides the numbers found in the literature, with special focus on average numbers used in control of Global Circulation Models (forest), as well as the resulting temperature of the deforested simulated area (cleared forest).

Uhl and Kauffman (1990) measured surface temperature over 62 consecutive days in four types of vegetation cover on a site in the Brazilian Amazon, providing an overview of what the important differences are between forest and cleared forest. For

Table 5.12. Temperature Values Used in the Calibration of the Atmosphere Sector

Reference	Land Cover/Land Use	Mean Annual Temp. (°C)	Min.Temp. (°C)	Max. Temp. (°C)	Note
Uhl and Kauffaman (1990)	Forest		22.0	27.7	Measured surface temperature
	Logged forest		21.8	37.5	Measured surface temperature
	Pasture		19.9	38.2	Measured surface temperature
	Secondary Forest		20.8	32.9	Measured surface temperature
Shukla et al. (1990)	Forest	23.5			Surface temperature (control value/GCM model)
Dickinson and Kennedy (1992)	Forest	25.8	21.8	31.1	Surface temperature (control value/GCM model)
	Cleared forest	26.4	21.6	33.7	Surface temperature (simulated value/GCM model)

Table 5.12. ... Continued.

Reference	Land Cover/Land Use	Mean Annual Temp. (°C)	Min.Temp. (°C)	Max. Temp. (°C)	Note
Lean and Rowntree (1993)	Forest	27.1			Surface temperature (control value/GCM model)
Polcher and Laval (1994)	Forest	26			Surface temperature (control value/GCM model)
Walker et al. (1995)	Cleared forest	24			Surface temperature (simulated value/GCM model)
	Cleared savanna	24.4			Surface temperature (simulated value/GCM model)
Sud et al. (1996)	Forest	26.2			Surface temperature (simulated value of a GCM model)
	Cleared forest	28.2			Surface temperature (simulated value/GCM model)

Table 5.12....Continued.

Reference	Land Cover/Land Use	Mean Annual Temp. (°C)	Min.Temp. (°C)	Max. Temp. (°C)	Note
Zhang et al. (1996a)	Forest	25.7			Surface temperature (control value of a GCM model)
	Cleared forest	26			Surface temperature (simulated value/GCM model)
Hahmann and Dickinson (1997)	Forest	27.3	22.1	34	Surface temperature (simulated value/GCM model)
	Cleared forest	28.3	22.5	35.9	Surface temperature (simulated value/GCM model)
Costa and Foley (2000)	Forest	25.6			Surface temperature (simulated value/GCM model)
	Cleared forest	27			Surface temperature (simulated value/GCM model)

instance, while diurnal temperature on the site described ranges from 22.0°C to 27.7°C, areas cleared for pasture had a documented range of 19.9°C to 38.2°C. According to their study, significantly higher values were found for maximum temperatures while other anthropogenic uses of the forest (i.e. logging and secondary forest) had slightly lower values for minimum temperature. Although this study is helpful in showing the effects of deforestation, it is limited to the particular site where the values were measured. The annual temperatures values described in GCM models, on the other hand, provide an aggregation for the entire region that is useful for the modeling effort of RUMBA. Control values (forest) used in such models, and the simulated values (cleared forest), as well as maximum and minimum values were as follows: forest mean oscillated between 23.5°C – 27.1°C, maximum between 31.1°C – 34°C, and minimum between 21.8°C – 22.1°C. Deforested mean oscillated between 24.0°C – 28.3°C, maximum between 33.7°C – 35.9°C, and minimum between 21.6°C – 22.5°C. The mean values of such GCM models (both control and simulated) were used in the calibration of the temperature values simulated in the atmosphere sector of the RUMBA.

5.6. Calibration with Simulation Models of Amazon Deforestation and Climate Change

Climate patterns are known to have a fundamental role in distribution of biomes and ecosystems. In the short-term, climate pattern refers mostly to regional precipitation and radiation, with vegetation cover having a strong influence on these processes.

Different rates of evapotranspiration are certain to affect rainfall patterns, especially those where precipitation is based on a water-recycling regime. Changes in the climate patterns over a longer-term, in turn, might lead species to adapt or migrate to more suitable

locations (Cunningham and Saigo, 1995). Paleorecord evidence of species migration and dispersion rapid enough to track climate change (Pitelka et al., 1997) shows the importance of these mechanisms in determining landscape cover.

Overall, a strong feedback is likely to be observed between climate and landscape cover, where climate affects vegetation cover, which in turn affects climate patterns. Effects of both climate and vegetation cover on soil processes, nutrient cycling and hydrological processes increase the complexity of this scenario. A review of models simulating the effects of large-scale deforestation of the Amazon on climate variables is shown on Table 5.16. Most of the models point to an increase in the surface temperature (in a range of 0 – 3°C), together with a significant reduction of evapotranspiration (149 – 985.5 mm yr) and precipitation (in a range of 0 – -1131.5 mm/yr) in the region. A decreased moisture convergence is also shown.

As a general rule, the effects of climate change on the landscape of the region are difficult to assess and may not be as intuitive as one might expect. A recent study by Nemani et al. (2003) showed a 6% global increase in NPP over 1982 – 1999, of which 42% was attributed to the Amazon rainforest. The increase is believed to be driven by decreased cloud cover and the resulting increase in solar energy over the region (ibid).

Table 5. 13. Simulation Models of Amazon Deforestation and Climate Change^a

Reference	Change in Temperature (°C)	Change in Precipitation (mm/yr)	Change in Evapotranspiration (mm/yr)	Change in Moisture Convergence (mm/yr)
Hendersons-Sellers and Gornitz (1984)	0.0	-219.0	-164.3	-54.8
Dickinson and Henderson-Sellers (1988)	+3.0	0.0	-204.4	204.4
Lean and Warrilow (1989)	+2.4	-489.1	-310.3	-178.9
Sud et al. (1990)	-	-547.5	-438.0	-109.5
Shukla et al. (1990), Nobre et al. (1991)	+2.0	-638.8	-500.1	-109.5
Dickinson and Kennedy (1992)	+0.6	-511.0	-255.5	255.5
Hendersons-Sellers et al. (1993)	+0.6	-587.7	-233.6	-354.1
Lean and Rowntree (1993)	+2.1	-295.7	-200.8	-94.9

a. Results are the differences between deforested minus control runs.

Table 5.13...Continued

Reference	Change in Temperature (°C)	Change in Precipitation (mm/yr)	Change in Evapotranspiration (mm/yr)	Change in Moisture Convergence (mm/yr)
Lean and Rowntree (1993)	+2.1	-295.7	-200.8	-94.9
Polcher and Laval (1994)	+3.8	+394.2	-985.5	-591.3
Walker et al. (1995)	-	-430.7	-292	-138.7
Zeng et al. (1996)	-	-1131.5	-730.0	-401.5
Zhang et al. (1996a)	+0.3	-402.0		-181.2
Sud et al. (1996)	-	-109.5	-73.0	-36.5
Lean et al. (1996)	+2.3	-146.0	-292	146.0
Lean and Rowntree (1997)	+2.3	-157.0	-295.7	138.7
Hahmann and Dickinson (1997)	+1	-363	-149	-214
Costa and Foley (2000)	+1.4	-255.5	-219	-36.5

5.7. Calibration of the Anthroposphere Sector

The calibration of the anthroposphere sector was essentially based on aggregation of socio-economic and environmental data for the important variables of population, waste, gross regional product (GRP) and trade. Table 5.14 shows the broad trends of population in the Brazilian Legal Amazon for the last four decades. During the 1970-2000 period the population of the region more than doubled. Furthermore, it experienced a significant process of urbanization as a result of both intra-regional migration and regional rural exodus to town and cities (de Almeida and Carvalho, 1995; Smithe et al, 1995).

Table 5.14. Population of the Legal Amazon, Brazil^a

	1970	1980	1990	2000
Total Population	8,193,636	11,015,363	17,907,903	22,231,657
Average geometric growth (%)	–	3.00	4.43	2.18
Urban Population	3,062,816 (44.7)	4,947,258 (55.9)	9,380,105 (67.6)	14,379,267 (75.6)
Rural Population	5,130,820 (55.3)	6,008,105 (44.1)	7,431,740 (32.4)	6,694,700 (24.4)

a. Author calculations based on IBGE (1996) and IBGE (2000), for the states of the North region plus Mato Grosso and Tocantins. Value in parathesis are percentage of total.

Urban areas of the frontier are subject to the same social and ecological problems of most Brazilian cities such as unemployment, poverty pollution and of an overall lack of basic services (Becker, 1995). Table 5.15 shows the estimations of waste produced in the region that were used to calibrate the stock of waste in RUMBA. My estimations

show that, on average only 50.6% of waste produced is collected. Furthermore, only 20% of the total waste collected is adequately disposed.

Table 5.15. Waste Produced in the Brazilian Legal Amazon (T yr⁻¹)^a

	1970	1980	1990	2000
Total Amounts	4,456,195.24	5,990,821.19	9,239,124.49	11,461,298.93

a. Author calculations based on IBGE (2002).Based on waste of 15,883.40 T/day (2000), which represents the waste produced by 76.2%, 53.4% and 87.6% of the urban populations of the North region, Maranhao and Mato Grosso, respectively, and 4.4%, 2.4%, 4.7% of the rural population of the same areas. Weighing waste collected by these urban and rural population, gives an overall per capita waste of 0.54T/capita.

Gross Regional Product (GRP) of the Brazilian Amazon is presented on Table 5.16 from 1985 to 2001. The Amazon GRP has experienced a substantial growth over this period. Its growth, similar to that of the Brazilian Gross Domestic Product (GDP), is also subject to the same economic shocks, appreciation and depreciation of exchange rate, etc, that affect the country's GRP. For instance, abrupt falls in GRP, such as those in 1992 and 1997, are explained by the economic shocks and currency devaluation undergone by the national economy. According to e Silva and Medina (1999) although the Amazon GRP contribution to the Brazilian GRP has been relatively stable for the last two decades (e.g. about 4.7%)¹, the overall contribution of cropland and pasture economic activities from regional GRP to those of the national GDP has grown from 4.7 in 1985 to 8.5 in 1998, which points to the increasing significance of these activities for the regional and national economy.

Table 5.17 shows the data used to calibrate the volume of imports and exports of the Brazilian Amazon. The regional trade-in particular international trade-follows

¹ North region only. Estimates by author for the nine states of the Legal Amazon show that the GRP is equivalent to 6.5% of the Brazilian GDP.

national trade trends, has experienced trade deficits for most of the period for which data was available. More recently, however, according to Gomes and Vergolino (1997) the trade balance of the Amazon has been showing signs of an increasing surplus, with a continuous growth of exports.

Table 5.16. Gross Regional Product (GRP) of the Legal Amazon, Brazil (1E6 US\$, 2001)

Year	Brazilian Currency (1E6)	GRP Legal Amazon ^a	Annual Average Exchange Rate to US\$ ^b	GRP (1E6) US\$	US Inflation Rate (Year base: 2001) ^c	GRP corrected for US\$ inflation (1E6 US\$ 2001)
1985	Cr\$	68,377	0.00016071	10,690.60	1.65	18,131.88
1986	Cz\$	204,088	0.07323325	14,146.74	1.62	24,212.53
1987	Cz\$	645,407	0.02530172	16,007.53	1.56	25,474.66
1988	Cz\$	5,008,505	0.00376546	18,641.95	1.5	28,288.97
1989	NCz\$	82,689	0.35360679	29,048.73	1.43	41,812.10
1990	Cr\$	2,086,242	0.01469378	29,319.56	1.36	41,690.50
1991	Cr\$	10,675,980	0.00244349	24,921.35	1.3	33,912.62
1992	Cr\$	107,139,024	0.00021972	23,191.20	1.26	29,660.81
1993	CR\$	2,747,754	0.01107972	30,793.70	1.23	37,446.54
1994	R\$	24,484	1.55038760	36,372.86	1.2	45,552.41
1995	R\$	41,533	1.08932462	41,896.42	1.16	52,482.20
1996	R\$	50,971	0.99482690	47,105.32	1.13	57,299.70
1997	R\$	55,072	0.55072145	28,126.29	1.1	33,362.43
1998	R\$	58,058	0.54659743	30,086.56	1.09	34,590.31
1999	R\$	62,936	0.42513392	25,053.70	1.06	28,361.71
2000	R\$	73,285	0.34119213	23,191.54	1.03	25,754.30
2001	R\$	81,772	0.42513392	32,188.09	1	34,764.03

a. Calculated by author based on IBGE (2004). All states of the Legal Amazon (North Region plus Mato Grosso and Maranhao).

b. BCB (2004).

c. BLS (2004)

Table 5.17. International and Interregional Trade Balance of the North Region (1E6 US\$, 2001)^a

Year	Interregional Exports	Interregional Imports	International Exports	International Imports	Total Export	Total Import	Trade Balance
1975	703	1,574	1,264	2,194	1,967	3,769	-1,801
1980	3,138 ^b	4,562 ^b	1,439	2,371	4,577	6,933	-2,356
1985	5,573	7,550	750	909	6,323	8,459	-2,136
1991	8,079	6,290	1,678	1,313	9,757	7,603	2,154

a. Based on Gomes and Vergolino (1995) values for the North region (excluding states of Mato Grosso and Maranhao). All values corrected for inflation by author based on BLS (2004).

b. Values calculated by author based on interpolation.

Chapter 6. Results

In this chapter I describe the results of RUMBA for the baseline as well as for the four simulated scenarios. The model was simulated from 1975 to 2100, with a one-year time step, and calibrated over the historical period of 1975 – 2000. Although the model simulates the dynamics of both forest and savanna land covers, their derived land uses, and provision of ecosystem services, the results presented here are exclusively those associated with forest land cover and its uses. This will allow analyzing the results in more detail and comparing similarities and differences of the outputs of RUMBA with other research on forest processes. Results of scenarios are compared to the baseline, as well as among themselves. Although I present the results for all scenarios, I will focus the discussion on scenarios of opposing policies, e.g. scenarios 1 (development) and 3 (conservation), because the obvious differences in the results in these scenarios.

6.1. Land Cover/Land Use Variables

Results for land cover/land use change are summarized in Figures 6.1 – 6.7. Figures 6.1 displays the forest annual deforestation rates, while Figures 6.2 – 6.7 show the dynamics of land change forest and of its anthropogenic uses (cropland, pasture, fallow and urban). In general, the results calibrate well with the historical data, as can be observed from the graphs, with the exception of fallow land in forest cover. Because the calibrated values for land uses derive from calculations based on the census survey (IBGE 1975; 1985; 1996), instead of more accurate remote sensing data, it is possible

that some data – arguably the fallow land use – is the product of some methodological error in the data collection.

Overall, results show a strong trend in land conversion from forest to other land uses and pasture in particular. In 1975, the originally forested area of Brazilian Amazon (Figure 6.3) was estimated at 3.8 million km², of which 99% was still covered with forest vegetation. In a 125-year simulated baseline, the Brazilian Amazon forest area declines to about 26% of its original cover, with only 1.0 million km² of forest remaining. Total area deforested reaches 51% by year 2050, and 2.9 million km² (74%) by the end of the simulation. Majority of the deforested land is devoted to pasture (Figure 6.5), which accounts for 40% of the land deforested by year 2100, followed by fallow and cropland land use. Taken together, pasture and fallow account for 63% of the deforested land in 2100. Annual rates of deforestation over time (Figure 6.1) – estimated at 0.3% of the remaining forest cover in 1975 – reach 1.3% of the forest cover in 2050. By the end of the simulation, annual deforestation rates remain as high as 1.3% of the remaining forest cover at that time.

As expected, deforested areas of the Brazilian Amazon under scenarios of increased development (1 and 2) are higher than that of the baseline and those of conservation scenarios (3 and 4). By the end of the simulation, deforested land in scenarios 1 and 2 reach 76 and 78%, respectively, while those of scenarios 3 and 4 are estimated at 69% and 73%, respectively. Although the percentage of deforested land at the end of the simulation period under scenarios 1 and 2 may not appear significantly higher than that of the baseline, estimated at 74%, a closer look at the annual deforestation rates under these scenarios shows that forest is cleared at a faster rate under

Scenarios 1 and 2 than in the remaining scenarios. For instance, while annual deforestation rates reach 25.9 thousand $\text{km}^2 \text{yr}^{-1}$ in the baseline scenario (in year 2050), they reach up to 27.1 and 28.5 thousand $\text{km}^2 \text{yr}^{-1}$ for scenarios 1 and 2, respectively. The rates of annual deforestation for scenarios 3 and 4 on that year are estimated at 22.6 and 24.7 thousand $\text{km}^2 \text{yr}^{-1}$, respectively.

6.2. Climate Variables

Results for climate variables of precipitation, evapotranspiration and regional temperature are displayed in Figures 6.8 – 6.11. Both precipitation (Figure 6.8) and evapotranspiration (Figure 6.9) decreased substantially over the simulated period. In year 2100, precipitation was 1.8 m km^{-2} , compared to 2.3 m km^{-2} in year 1975 – a 23% reduction over the period. The decrease in evapotranspiration was 26 % from the initial 1.3 m km^{-2} . Regional average temperature (Figure 6.10) increased nearly 11% over the simulated period, reaching 24.6°C by year 2100. Precipitation and evapotranspiration rates were slightly lower and temperatures slightly higher in scenarios of increased infrastructure when compared to the baseline and scenarios of conservation, although the difference was not very expressive.

The carbon balance (Figure 6.11a) in the land cover forest shows a significant trend of decreasing uptake and increasing atmospheric emissions – clearly a result of removal of vegetation. At the beginning of the simulation, the Brazilian Amazon forest carbon uptake is estimated at 2.4 Pg yr^{-1} , while emissions are estimated at about 0.1 Pg yr^{-1} . By year 2064, the forest emissions surpass forest uptake, with the Amazon becoming a net source of carbon to the atmosphere. By the end of the simulation, the net carbon balance in the baseline scenario is estimated at -0.6Pg yr^{-1} . For the region as a whole

(Figure 6.11b), the carbon balance, although also following a trend of decreasing uptake over the simulated period, remains positive until the end of simulation, when uptake is slightly above emission levels. This pattern of regional carbon balance is most certainly the result of the uptake of carbon by biomass replacing forest.

6.3. Ecosystem Services Variables

Results for the ecosystem services – their biophysical amounts and contribution to the regional economy – are displayed in Figures 6.12 – 6.31. Figures 6.12 – 6.18. display biophysical amounts of forest ecosystem services for all scenarios, illustrating changes in their availability as a result of land cover change under different policy choices and assumptions. The estimated monetary value of each forest service and for all scenarios is shown next in Figures 6.9. – 6.25. Finally, the provision of services from forest is compared to those from cropland and pasture under the baseline scenario to demonstrate net losses or gains. The results are shown in Figures 6.26 – 6.31.

The results of simulation show that ecosystem services decrease substantially over time with removal of vegetation. Overall, provision of most forest services decline by more than 70%, with the recreation and culture service declining by about 90% and organic soil formation declining by 57%. Ecosystem services were mostly sensitive to changes in the policy of simulated scenarios. As a general rule, higher losses of ecosystem services were observed in scenarios of induced development. The monetary valuation of the ecosystem services yielded increasing prices per unit of service and a reasonable sensitiveness to the different policies of simulated scenarios. This result is consistent with the chosen algorithm for the monetary valuation, which was based on the overall contribution of the ecosystem services to the regional economy and on the level of

scarcity of the ecosystem services. It is also consistent with the inelasticity of the demand of ecosystem services, where slight changes in the provision of such services result in significant changes in their estimated monetary prices.

Finally, the comparison of services from forest with that from anthropogenic land use shows the high magnitude of losses of services with land use change (Figures 6.26 – 6.31). This is especially evident when the availability of services per unit area is given, as shown on Table 6.1. For instance, by year 2100, the average forest recreation and culture service was equivalent to 2.3 E3 T of C SNI⁻¹ km⁻² yr⁻¹ compared to 9.3 and 9.5 Ton C SNI⁻¹ km⁻² yr⁻¹ of cropland and pasture, respectively. Plant nutrient uptake is another important loss, estimated at 4.2 Ton N km⁻² for forest, and 0.9 Ton N km⁻² yr⁻¹ for both cropland and pasture, in the same year. As a result of a magnitude difference in the provision of these services by unit area, by the end of the simulation the total provision of forest ecosystem services still outweigh the provision of services those from the anthropogenic uses of vegetation – despite the substantial reduction in the forest area.

6.4. Capital Variables

Figures 6.32 – 6.38 display changes in selected capital variables simulated in the model for baseline and alternative scenarios. Amazon population – which calibrates reasonably well for the historical period of 1975-2005 – grows over the simulated period reaching about 61.2 million people by the end of simulation in the baseline scenario (Figure 6.32). Overall, scenarios of increased investment in built capital yield slightly higher population numbers when compared with scenarios of increased investment in

natural capital. For instance, scenario 1 yielded 66.3 million people by 2100, compared to 55.1 million in scenario 3.

Table 6.1. Average Values of Ecosystem Services Provision for Forest, Cropland and Pasture for simulated period ^a

	Unit	Forest	Cropland	Pasture
Recreation and Culture	Ton C SNI ⁻¹ km ⁻²	2,514.3	9.3	9.5
Gas Regulation	Ton C km ⁻² yr ⁻¹	812.5	322.1	351.5
Climate Regulation	°C Ton C ⁻¹ yr ⁻¹ km ⁻²	34.8	13.8	15.0
Disturbance Regulation	Ton C km ⁻²	23,551.8	879.6	896.4
Plant Nutrient Uptake	Ton N km ⁻² yr ⁻¹	4,1	0.9	0.9
Organic Soil Formation	Ton C km ⁻² yr ⁻¹	943.5	91.0	98.0

a. Average value for the simulated period 1975-2100.

The stock of Built Capital (Figure 6.33) also shows a substantial growth over time in the baseline scenario. Stock of built capital – estimated at the beginning of the simulation period at about US\$ 554.9 billion – grows up to US\$ 15,008.7 billion by year 2100. The stock of Built Capital per capita (Figure 6.34) grows from US\$49.5 thousand at the beginning of the simulation to US\$245.1 thousand by year 2100. As expected, scenarios of increased investment in built capital (scenario 1 and 2) show a significant increase in the stock of built capital, as well as in the stock of built capital per capita, while scenarios with increased investment in natural capital yield opposite results. Under scenario 1, Built Capital and Built Capital per capita by year 2100 are estimated at US\$

23,197 billion and US\$ 349.9.7 thousand per person, respectively. Scenario 3, on the other hand, has Built Capital estimated at the end of the simulation at about US\$ 7,372.5 billion, while its per capita value is estimated at US\$ 133.8 thousand.

The stocks of Knowledge Capital (Figure 6.34) and Knowledge Capital per capita (Figure 6.35) also grow substantially over time under the baseline scenario, increasing from US\$ 47.8 billion and US\$ 4.3 thousand per person in year 1975 to US\$ 810.8 billion and US\$ 13.2 thousand per person by year 2100, respectively. Compared to the baseline, scenarios of increasing Built Capital (1 and 2) yield lower values of Knowledge and Knowledge per capita, while scenarios of an increasing Natural Capital investment (scenarios 3 and 4) yield higher values for these variables.

Finally, the stock of Social Network – unlike the two other capitals – shows a significant increase over the first 10 years of simulation, followed by a steady state condition after that. Social Network Index (SNI) estimated at the beginning of the simulation at about 4.2, reaches 9.8 by year 2018 and 9.9 by end of simulation. As a result, Social Network per capita – estimated at 0.4 SNI per million people in 1975 – grows rapidly during the first ten years, decreasing significantly after that. By the end of the simulation period, Social Network per capita is estimated at 0.16 SNI per million people. Although unlike other capitals Social Network shows only slight changes with opposing policy choices and assumptions of the scenarios, it remains higher on scenarios of increased investment on Natural Capital.

6.5. Economic Variables

Economic variables – both as the overall stock, stock per capita and calibration value (whenever applicable) – are displayed in Figures 6.39 – 6.42 for the baseline and

alternative scenarios. Results show that as a general rule, the Amazon region experiences increasing economic growth for the simulated period. Gross regional product (GRP) (Figure 6.39) estimated at US\$18.8 billion in 1975 reaches US\$ 141.9 billion by the end of the baseline scenario. Gross regional product per capita (Figure 6.40) experiences an increase of more than a third of its value over the simulated period, from US\$1.7 thousand at the beginning to US\$2.3 thousand at the end of the simulation. Different policy choices in the alternative scenarios yielded different results for GRP and GRP per capita when compared to the baseline scenario. For instance, scenario 1 (increased investment in Built Capital) yielded a GRP of US\$ 152.9 billion, and GRP per capita of US\$2.3 thousand per person in year 2100. GRP and GRP per capita for scenario 2 were estimated at US\$175.3 billion and US\$2.6 thousand per person in year 2100. Scenario 3 (increased investment in Natural Capital), on the other hand, has a GRP of US\$99.7 billion, and GRP per capita of US\$1.8 thousand per person in the same year, while these values are estimated at US\$121.1 billion and US\$2.1 thousand per person, respectively, on scenario 4.

Goods and Services Economic Production (GSEP) – which accounts for the contribution of all capitals, including that of ecosystems services – also grows substantially over the simulated period, and following a similar trend as GRP. In the baseline scenario, GSEP (Figure 6.41) and GSEP per capita (Figure 6.42) were estimated at about US\$311.4 billion and US\$27.8 thousand per person in year 1975. By the end of the simulation of the baseline, these values increase up to US\$2,063.9 billion and to US\$33.9 thousand per person, respectively. Throughout the simulation, GSEP value is estimated at more than ten times the value of GRP. Scenarios 1 yielded GSEP of

US\$2,325.3 billion by the end of the simulation, and GSEP per capita of US\$35.2 thousand by the end of the simulation. Scenario 3, on the other hand yields GSEP of US\$1,527.9, and GSEP per capita of US\$27.9 thousand per person in year 2100, respectively.

6.6. Welfare Variables

Welfare variables for the baseline and alternative scenarios are displayed in Figures 6.43 – 6.44. The index of Regional welfare (Figure 6.43), estimated at 5.3 at the beginning of the simulation, increases rapidly for the first few years peaking at 9.4 in 1990. By the end of the simulation of the baseline, the regional welfare index is as low as 2.8. Scenario 3 yielded the highest value of welfare and welfare per capita compared to all scenarios.

Welfare per Gross Regional Product (GRP) – estimated as the welfare index per US\$ billion – gives a dimension of the contribution of the economy to people’s welfare. Overall, the welfare per GRP decreases significantly over the simulation period under all scenarios. For the baseline scenario welfare per GRP, estimated at 2.5×10^{-5} in 1975, decreases to 3.2×10^{-7} in 2100. At the end of the simulation welfare per GRP of scenario 2 is the lowest among all scenarios. The welfare per GRP of scenario 3, estimated at 5.4×10^{-7} , is the highest among all scenarios.

6.7. Compensation for Avoided Deforestation

Figures 4.45 and 4.46 display the results of the economic impact of potential compensation for avoided deforestation under scenario 3 in relation to the baseline. The choice of using this scenario is based on current rules of carbon emissions trade, where

negotiations are normally based on reduction of emissions in relation to a determined baseline scenario. Hence, the difference between rates of deforestation in scenario 3 and those of the baseline determines the avoided deforested area. The monetary compensation is in the form of payment for the avoided forest carbon loss – measured as the avoided deforested area times the carbon of forest vegetation in that area.

The theoretical framework for this analysis is a Potential Pareto Improvement (PPI), where those being made better off with reduced emissions, e.g. the community of the world as a whole, could compensate those that are made worse off, e.g. the land owners of the Brazilian Amazon, for their economic losses. Unlike Kaldor-Hicks criteria for PPI however, where improvement is obtained whether or not compensation takes place, for the purpose of the analysis conducted here, I assume that improvement, and therefore practical changes, will not occur unless a reasonable compensation to pay off losses takes place.

The basic premise under this assessment is that the region would engage in the pursuit of a scenario of increased investment in Natural Capital, if compensated for doing so. An assumption is made that in order to do so, the monetary compensation would be equivalent to the area between the GRP of scenario 3 and that of the baseline (e.g. the difference between the GRP of baseline minus that of scenario 3), which is equivalent to the economic loss associated with engaging in scenario 3. The payment is calculated based on the model output of biomass per unit area at any given year (estimated in scenario 3 as an average 14 thousand Ton C per km²) and an assumed price per ton of carbon. Once the compensation is estimated, it is added to the economic production of the Anthroposphere sector of the model, in order to be reinvested in the economy according

to the investment rates that are determined for the scenario 3. The new GRP estimated by the model under these conditions accounts for the monetary compensation for avoided emissions.

Two forms of compensation were assessed. First, a compensation based on a single payment for the avoided deforestation, the payment being based on the output of biomass per unit area and a carbon market price of US\$10, US\$100 and US\$200 per ton of carbon (Figure 4.46). Second, a compensation was assessed based on a continuous flow of payment for the cumulative carbon emission avoided time for the period of simulation using the carbon market price of US\$5 and US\$10.00 per ton of carbon (Figure 4.47). A single payment refers to a one-time payment for the avoided emission in any given year. A continuous compensation, on the other hand, entails annual payments for the avoided emission from the time the avoided emission is estimated to the remaining simulated period (e.g. until 2085).

Results show that a single payment based on the carbon market price for the avoided emissions does not have a significant impact on the economy in relation to the baseline. The GRP with single compensation for avoided deforestation based on the US\$10 market price per ton of C is virtually unchanged from the baseline – implying too low of a compensation (Figure 6.45). A calculated ‘ideal price’ varies over time due to different simulated rates of deforestation and biomass, but its average is estimated at US\$200 per Ton of Carbon – a much higher price than the US\$10 per Ton of Carbon used in the first compensation. On Figure 4.46 is the result of a compensation that considers a flow of payment over time for the avoided cumulative deforestation under the compensation of \$10 per Ton of Carbon. Under these circumstances, the GRP with

compensation is slightly above that of the baseline, which represents a significant improvement in relation to GRP of scenario 3.

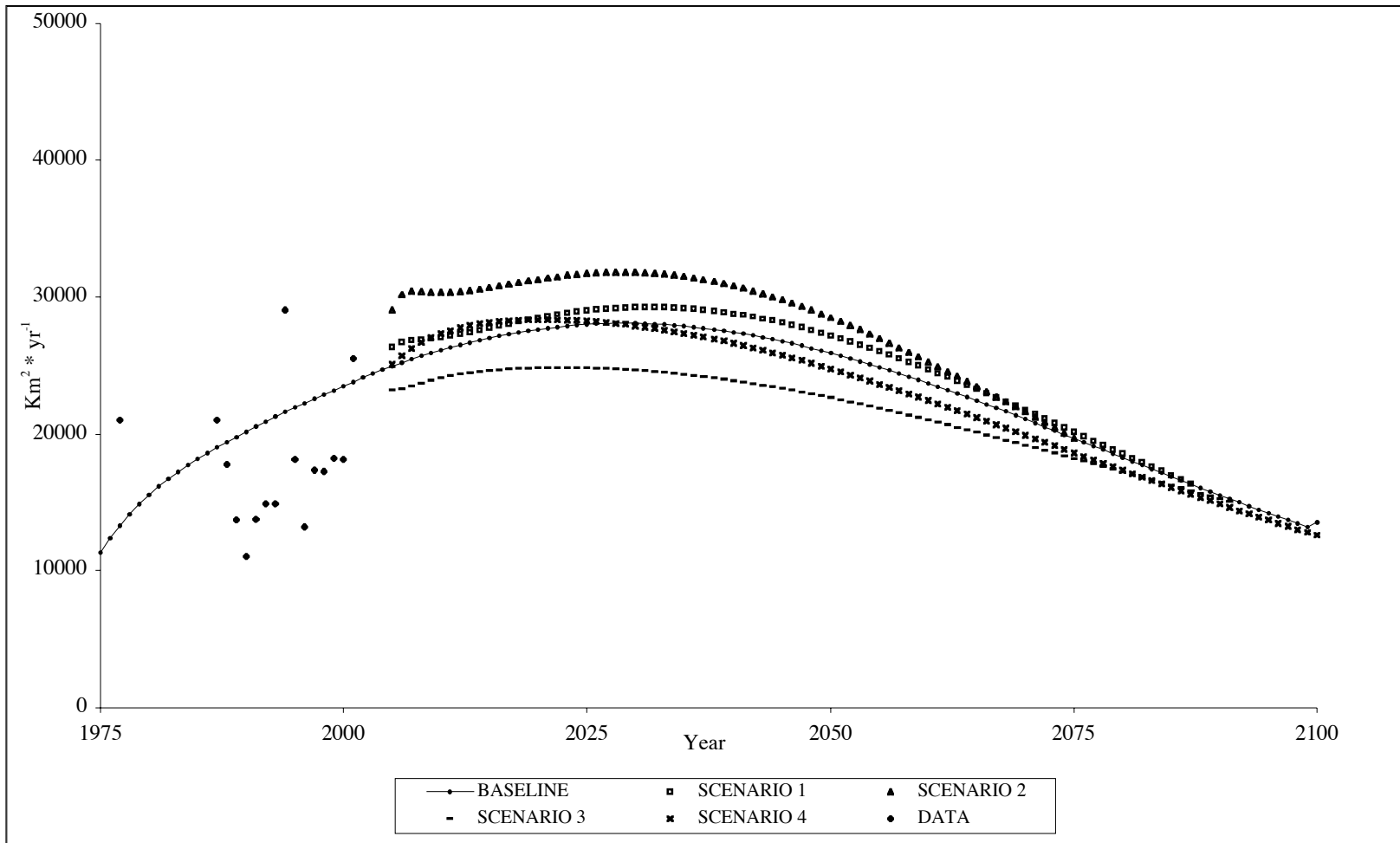

Figure 6.1. Forest, Annual Deforestation Rates.

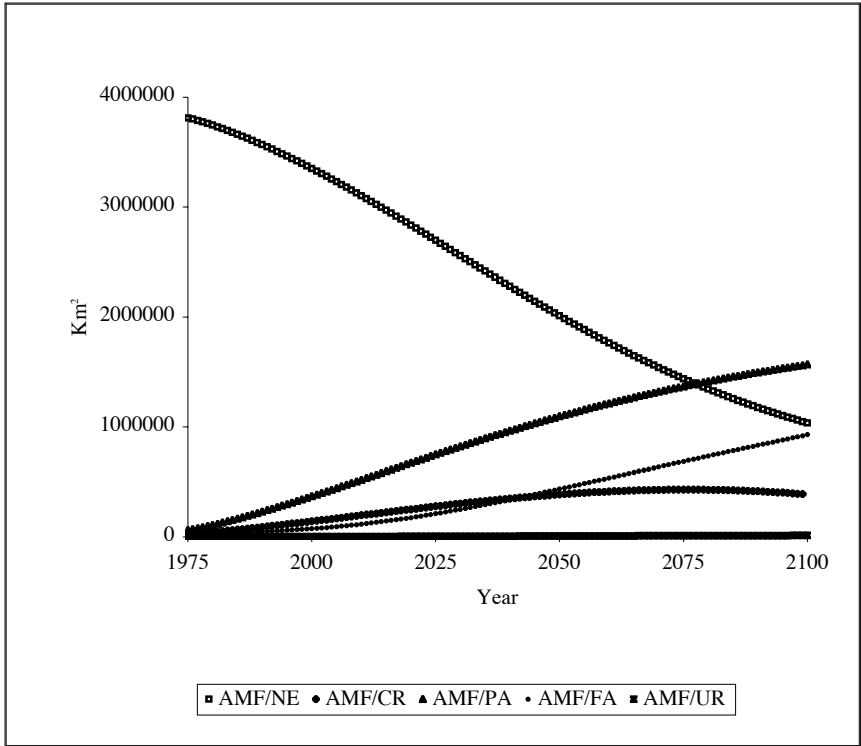

Figure 6.2. Forest, All Land Cover and Uses.

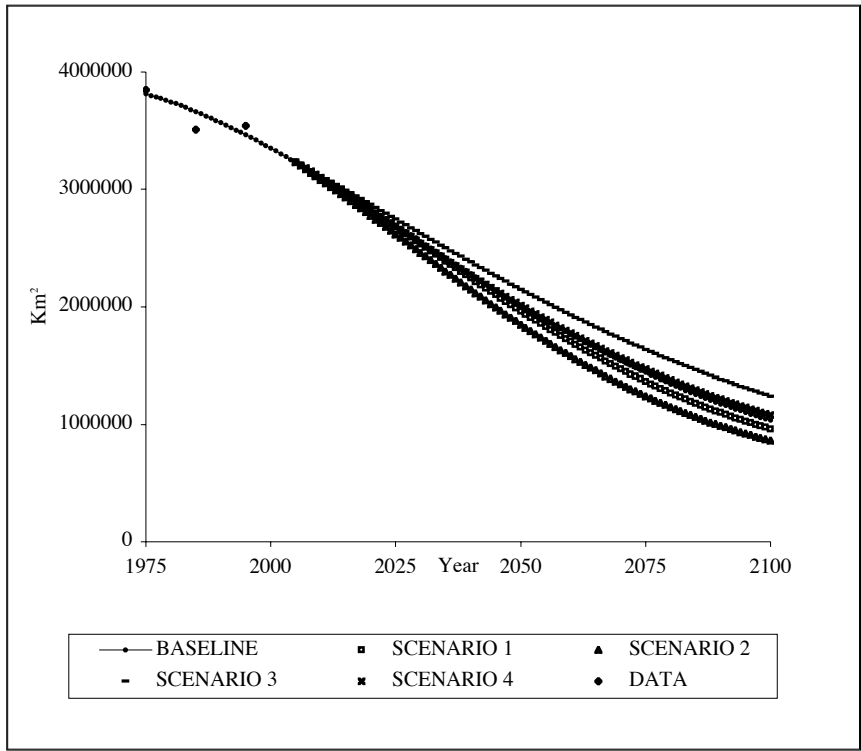

Figure 6.3. Forest Cover, Remaining Forest.

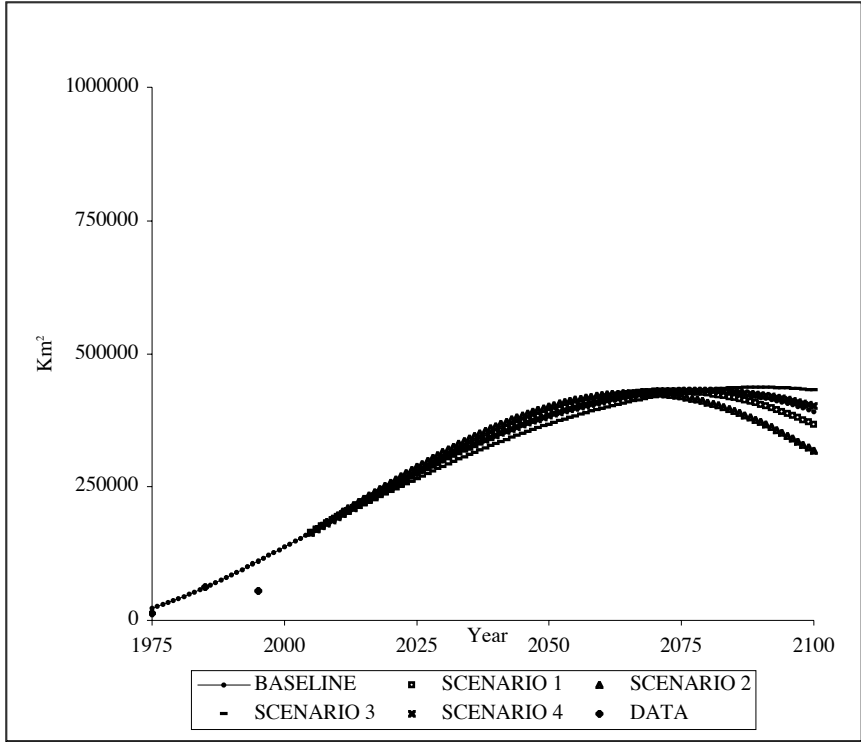

Figure 6.4. Forest Cover, Cropland Use.

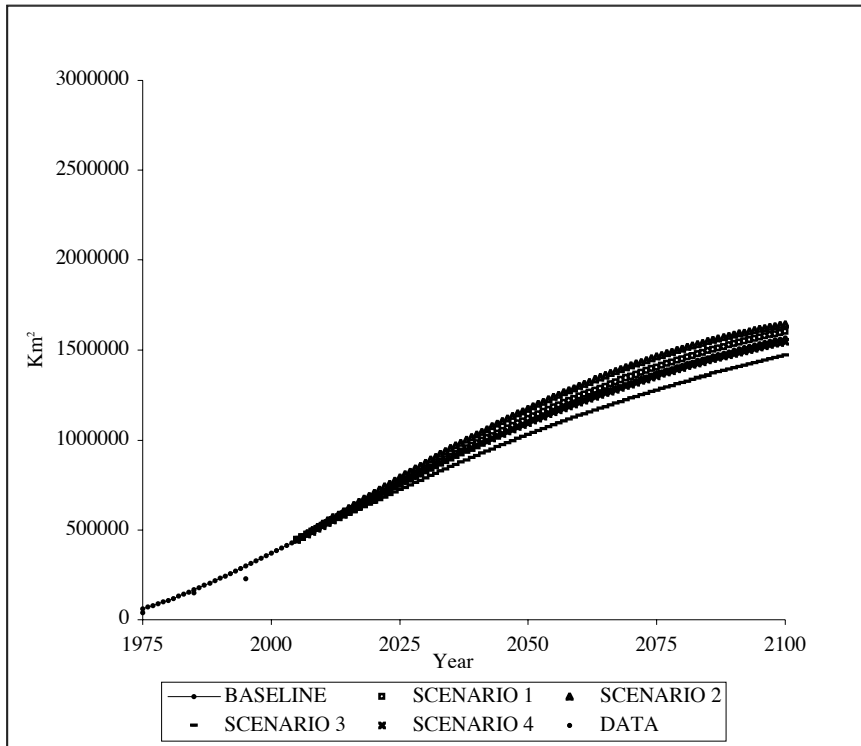

Figure 6.5. Forest Cover, Pasture Use.

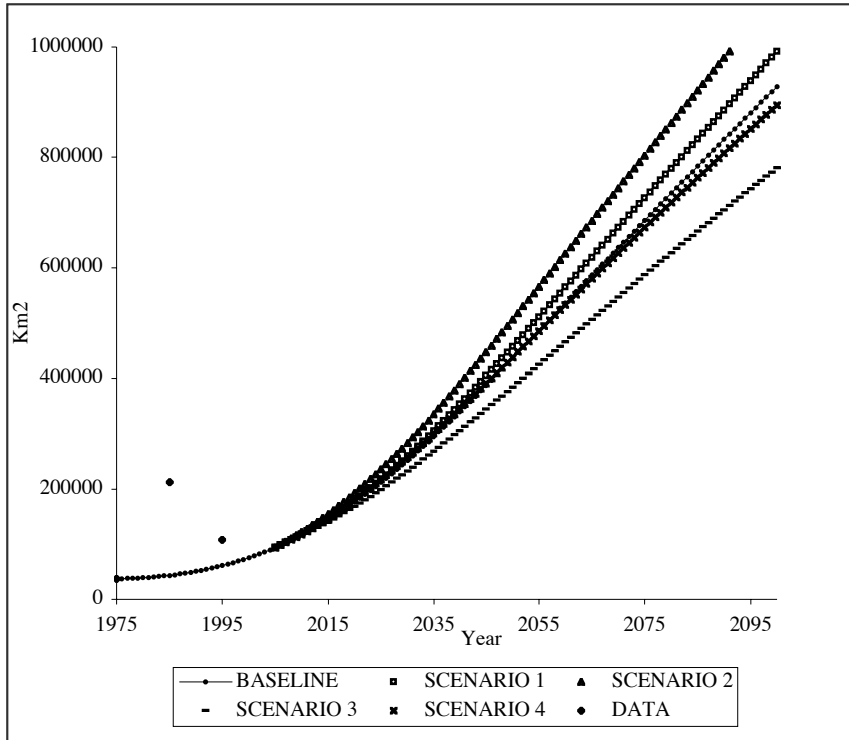

Figure 6.6. Forest Cover, Fallow Use.

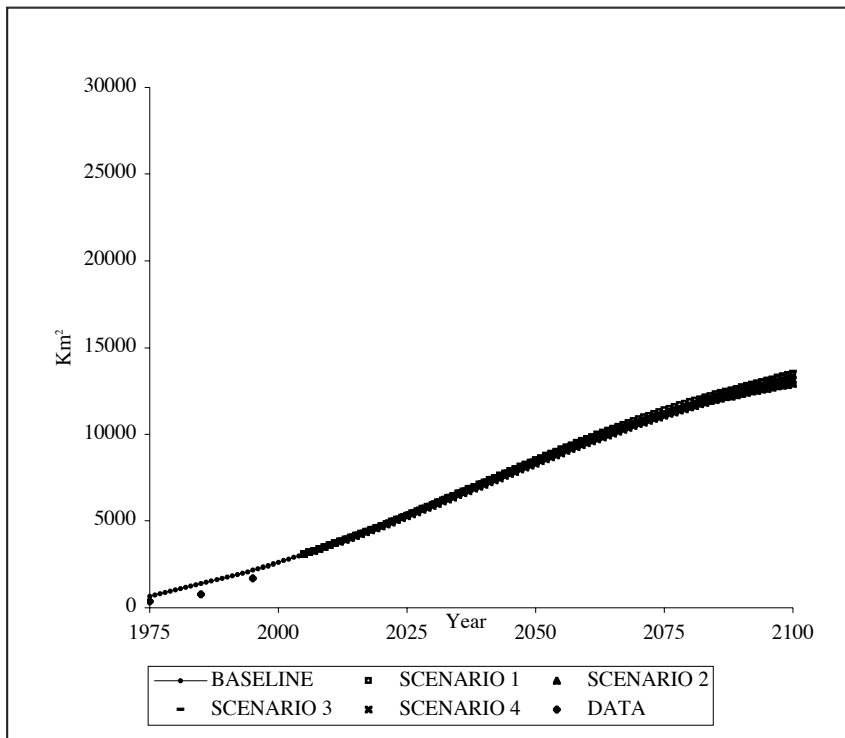

Figure 6.7. Forest Cover, Urban Use.

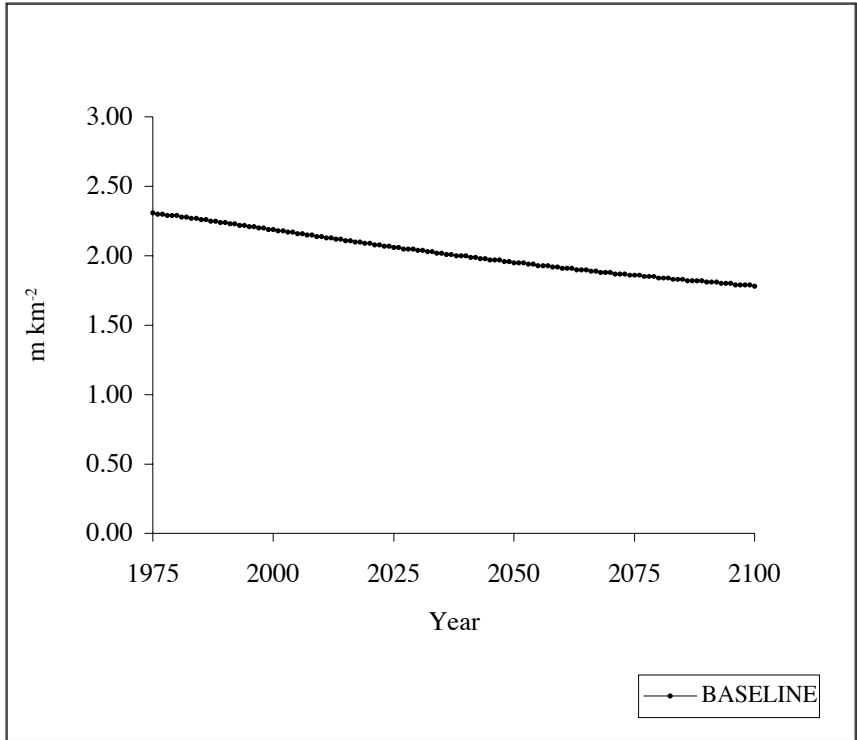

Figure 6.8. Precipitation per Unit Area.

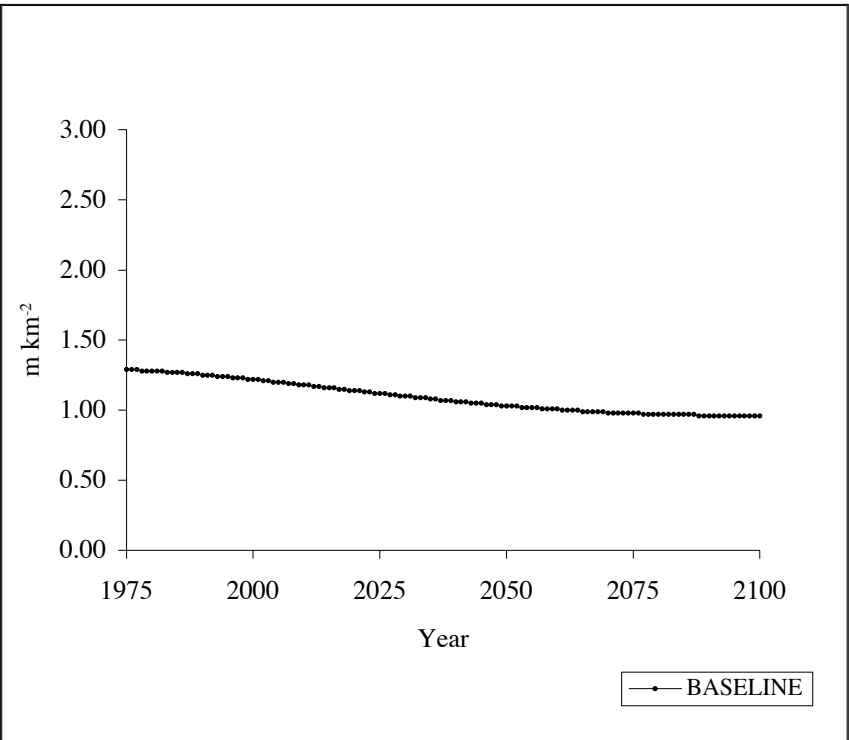

Figure 6.9. Evapotranspiration per Unit Area.

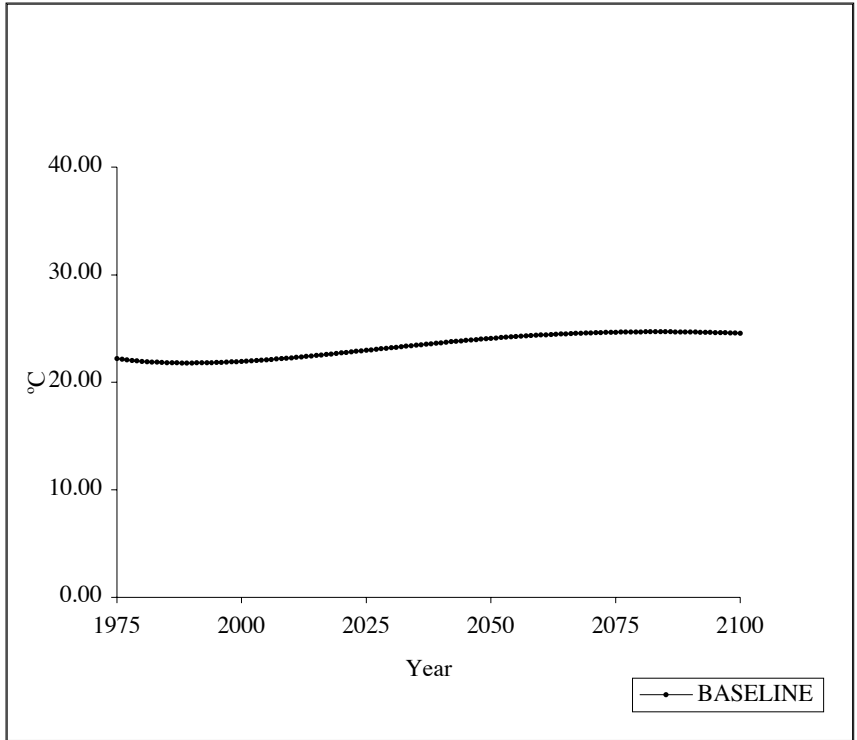

Figure 6.10. Regional Temperature.

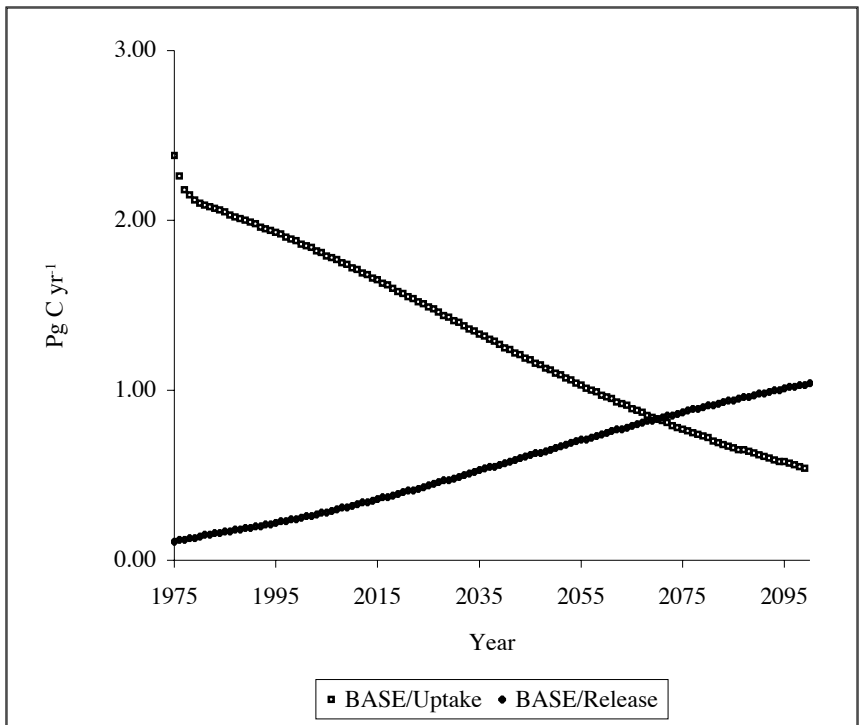

Figure 6.11a. Forest Carbon Balance.

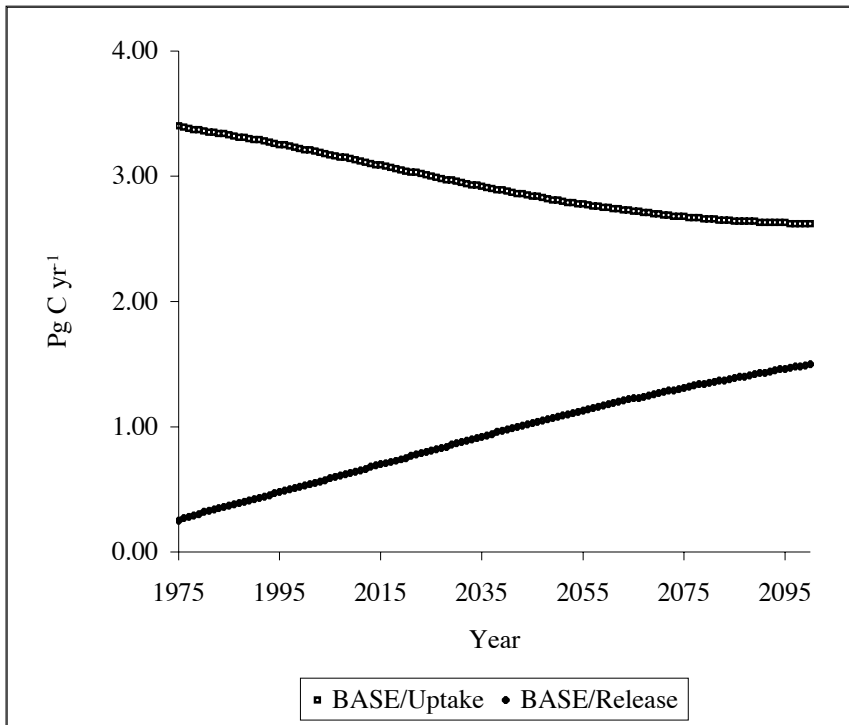

Figure 6.11b. Amazon Carbon Balance.

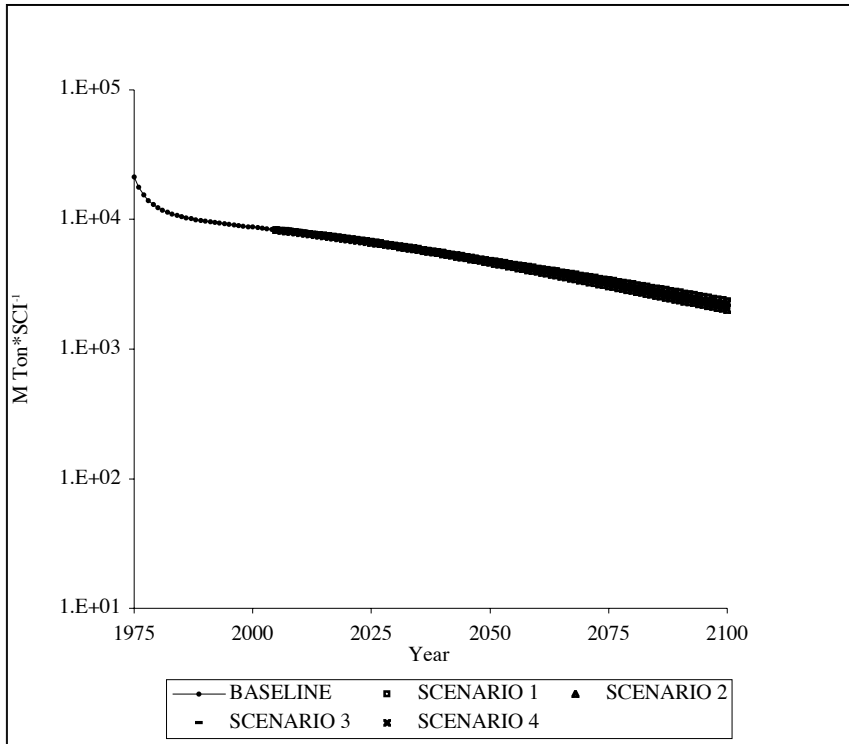

Figure 6.12. Recreation and Culture Service, Amounts/Forest.

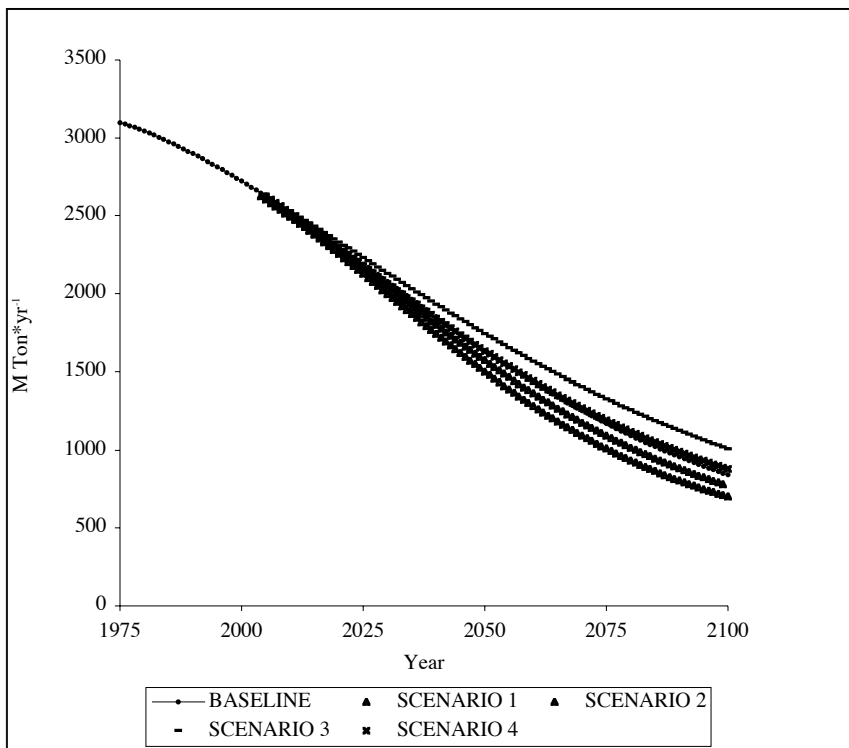

Figure 6.13. Gas Regulation Service, Amounts/Forest.

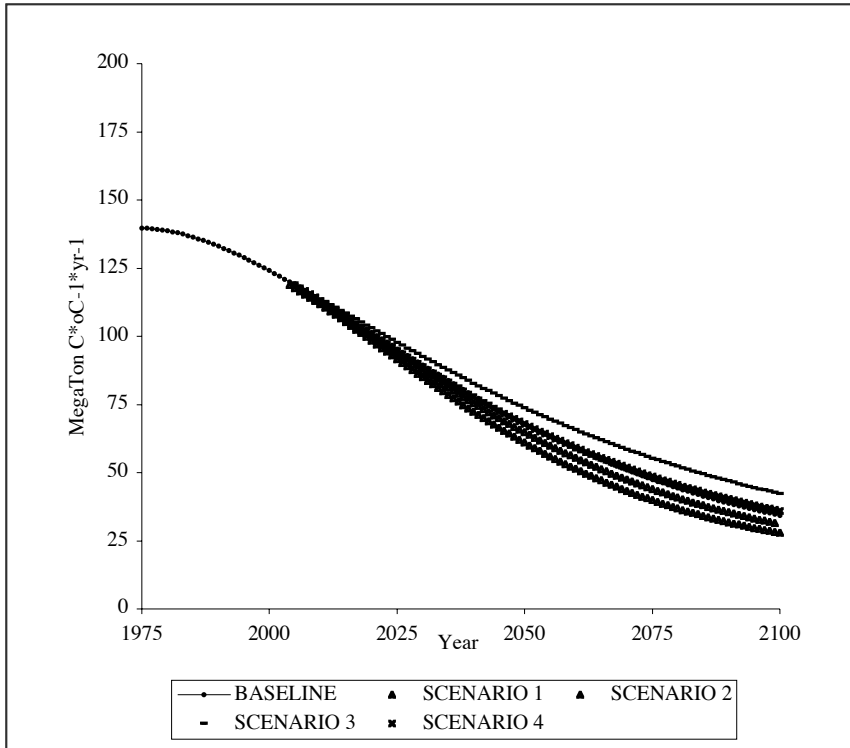

Figure 6.14. Climate Regulation Service, Amounts/Forest.

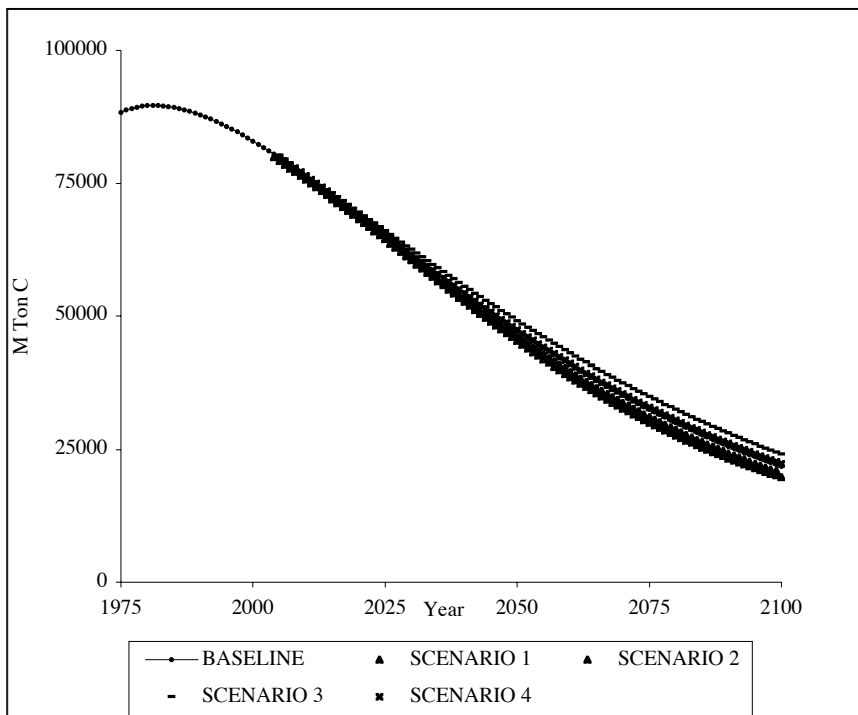

Figure 6.15. Disturbance Regulation Service, Amounts/Forest.

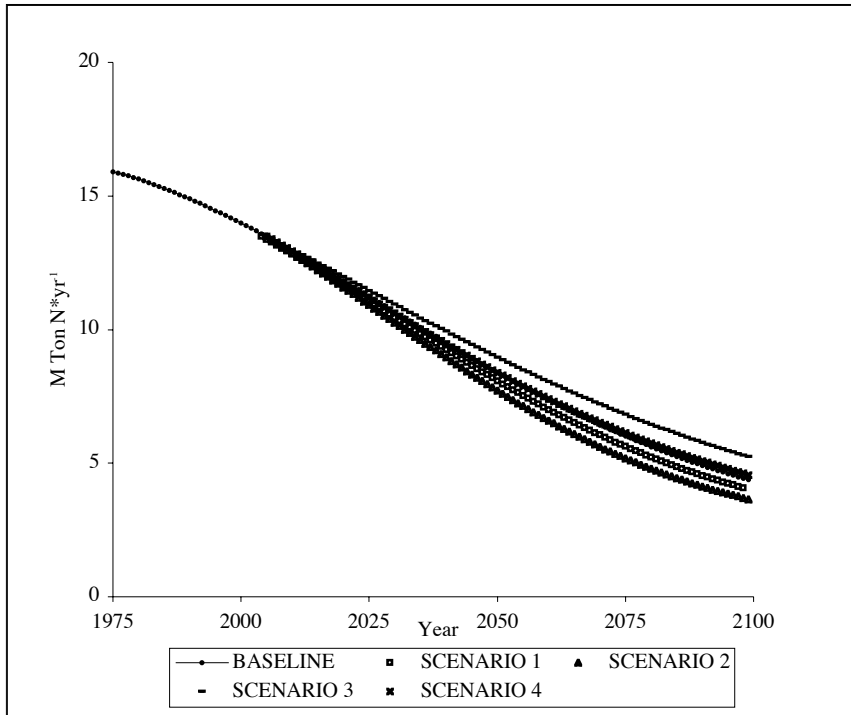

Figure 6.16. Plant Nutrient Uptake Service, Forest.

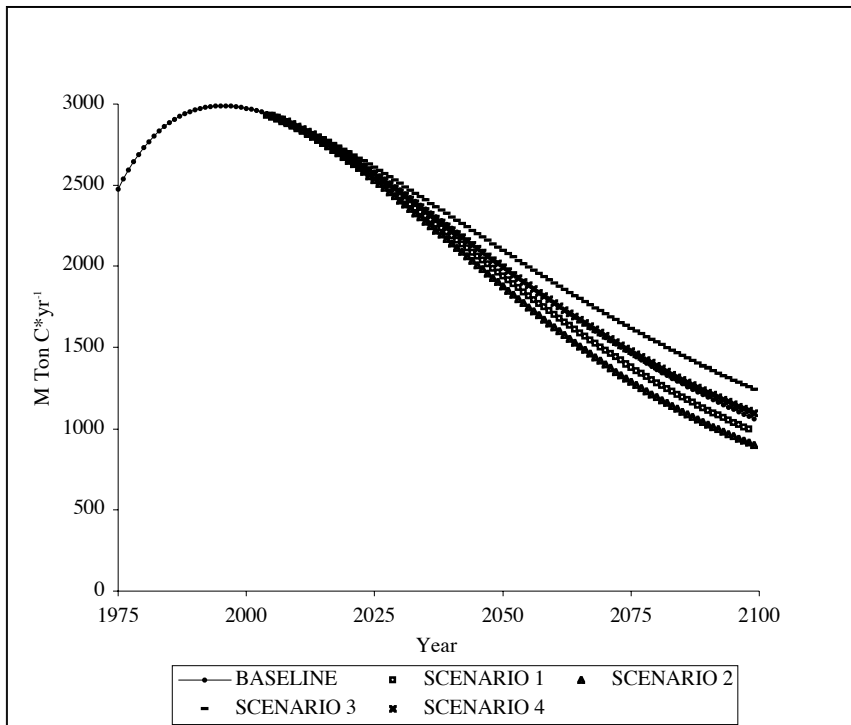

Figure 6.17. Organic Soil Formation, Forest.

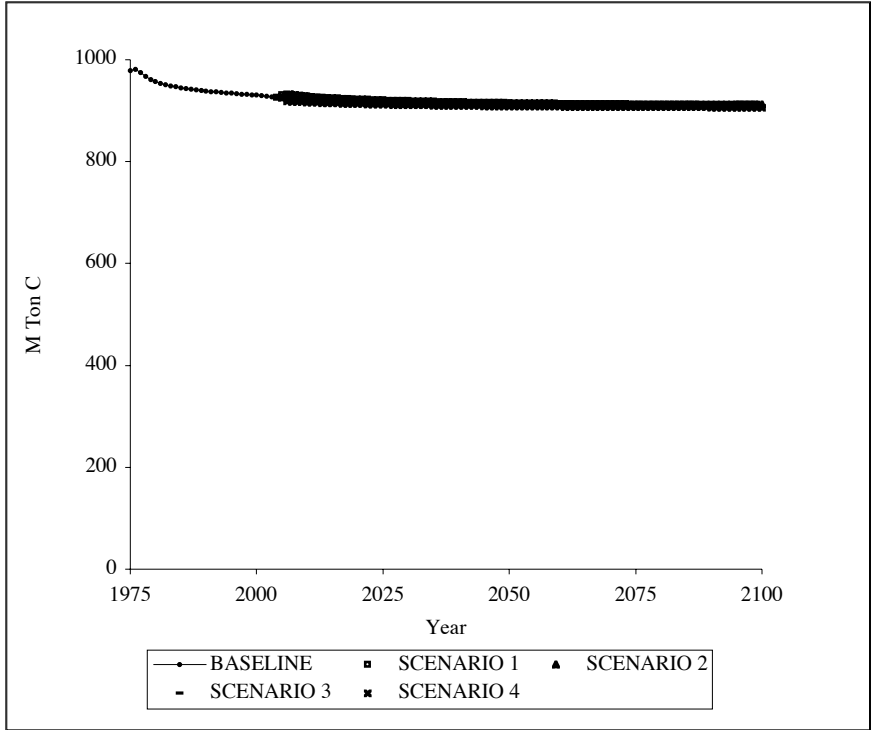

Figure 6.18. Waste Assimilation Potential/Regional

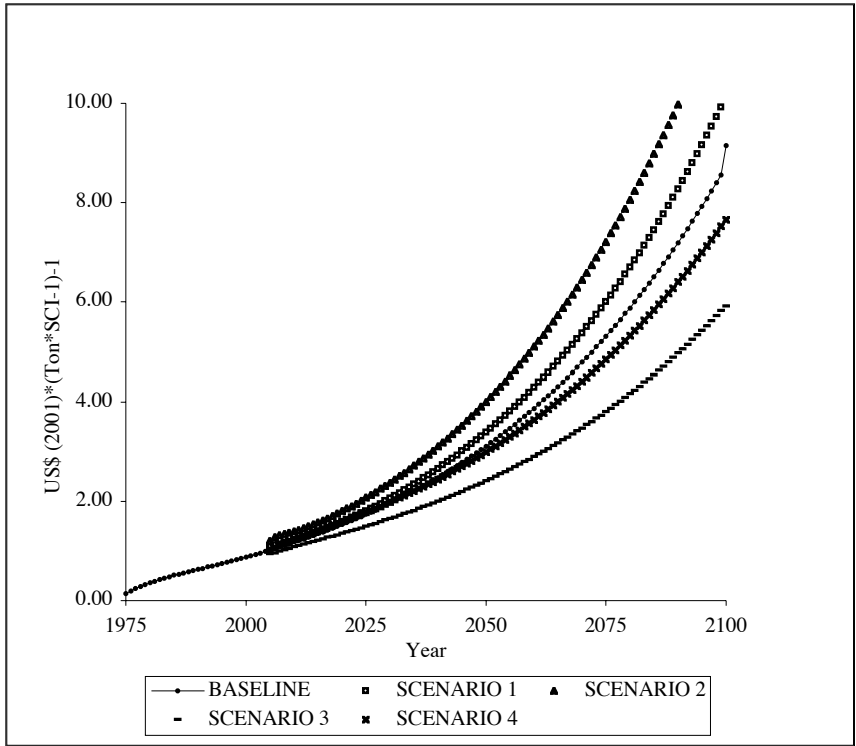

Figure 6.19. Recreation and Culture Service, Price per Unit/Forest.

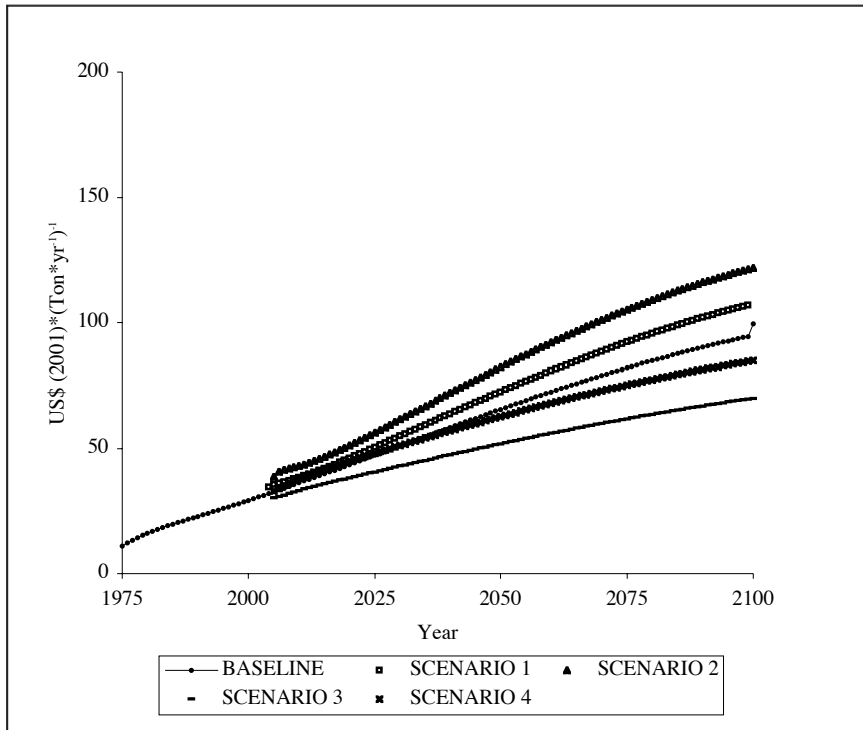

Figure 6.20. Gas Regulation Service, Price per Unit/Forest

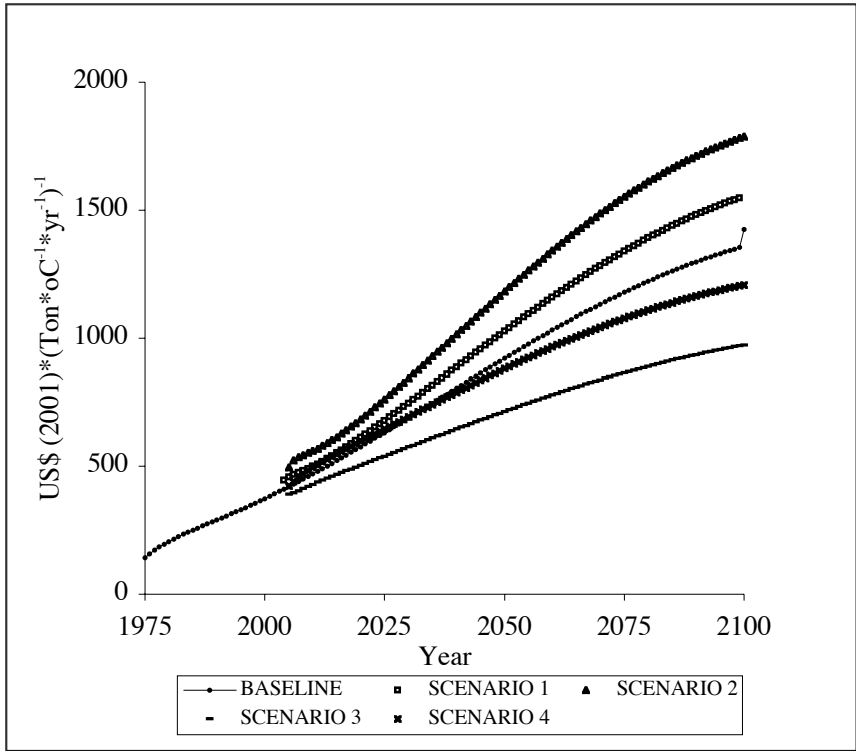

Figure 6.21. Climate Regulation Service, Price per Unit/Forest.

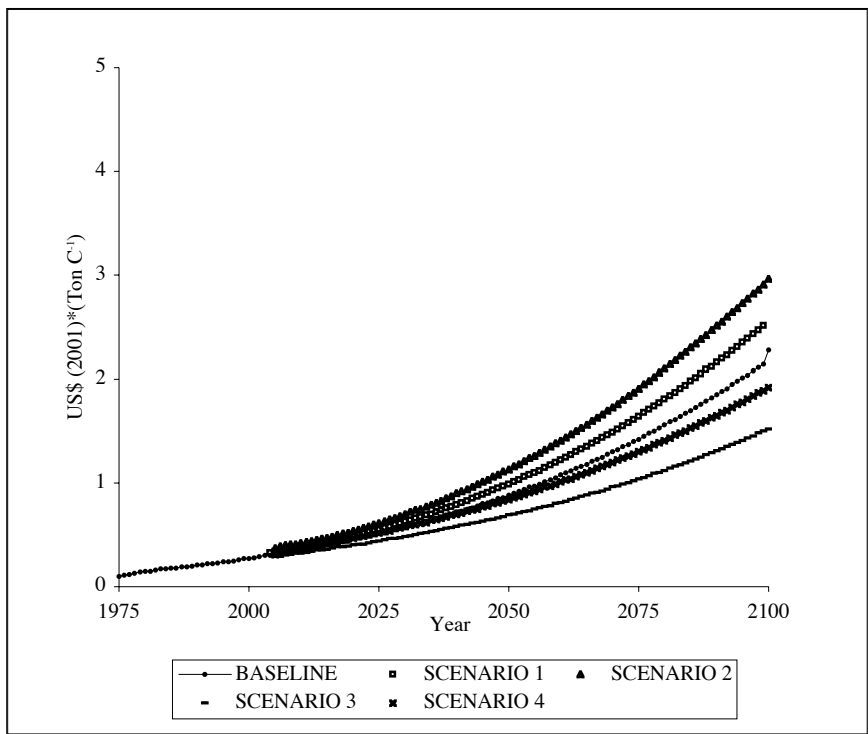

Figure 6.22. Disturbance Regulation service, Price per Unit/Forest.

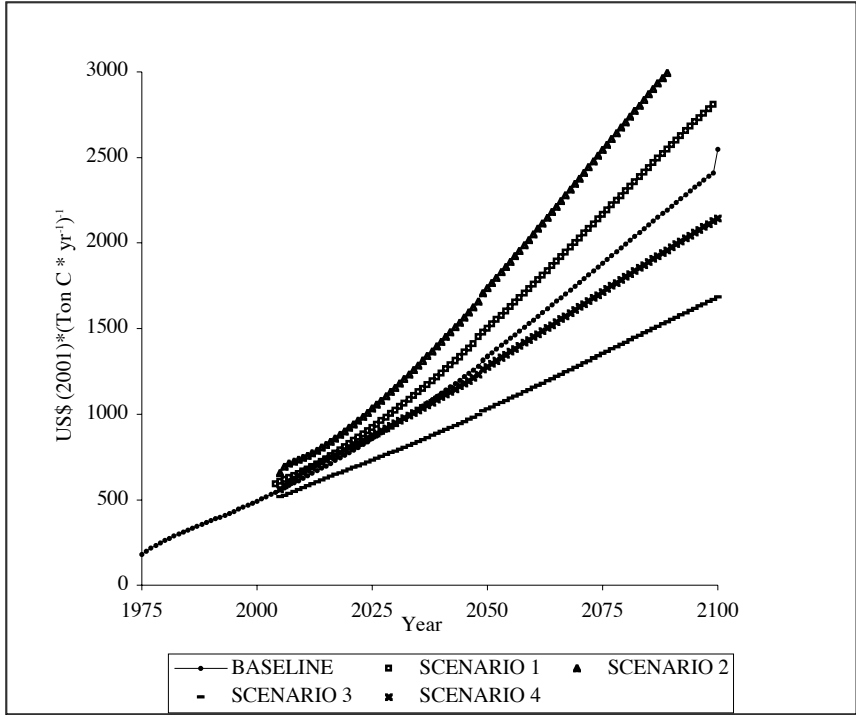

Figure 6.23. Plant Nutrient Uptake Service, Price per Unit/Forest.

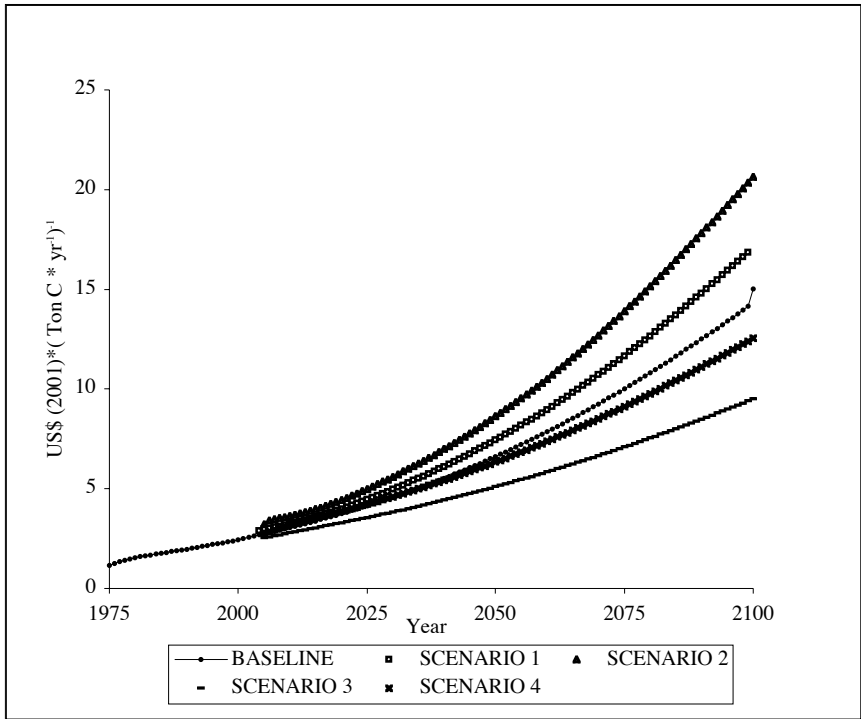

Figure 6.24. Organic Soil Formation, Price per Unit/Forest.

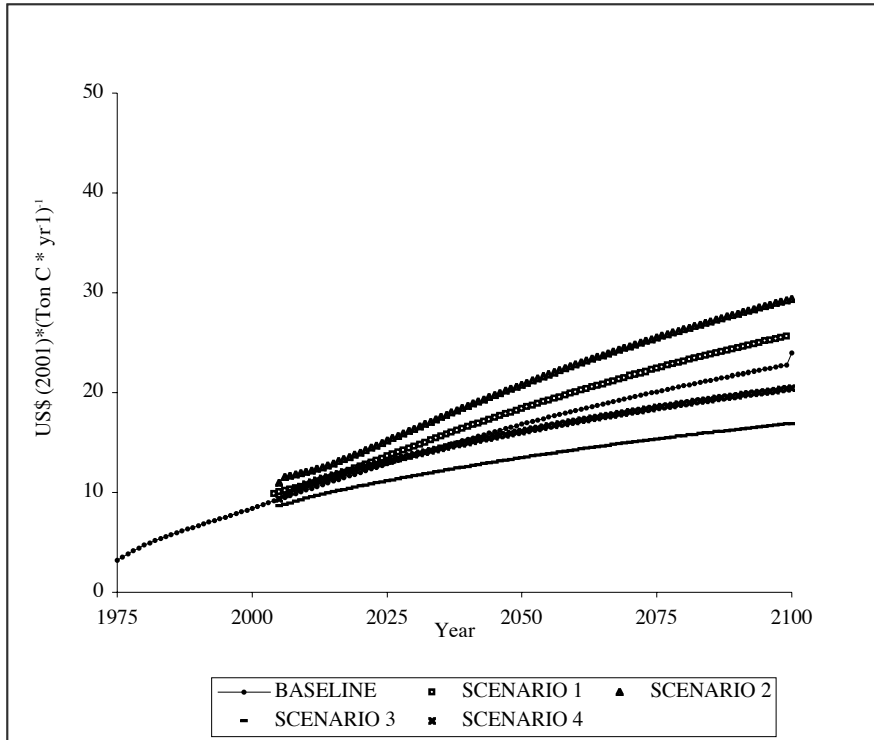

Figure 6.25. Waste Assimilation Potential, Price per Unit/Region.

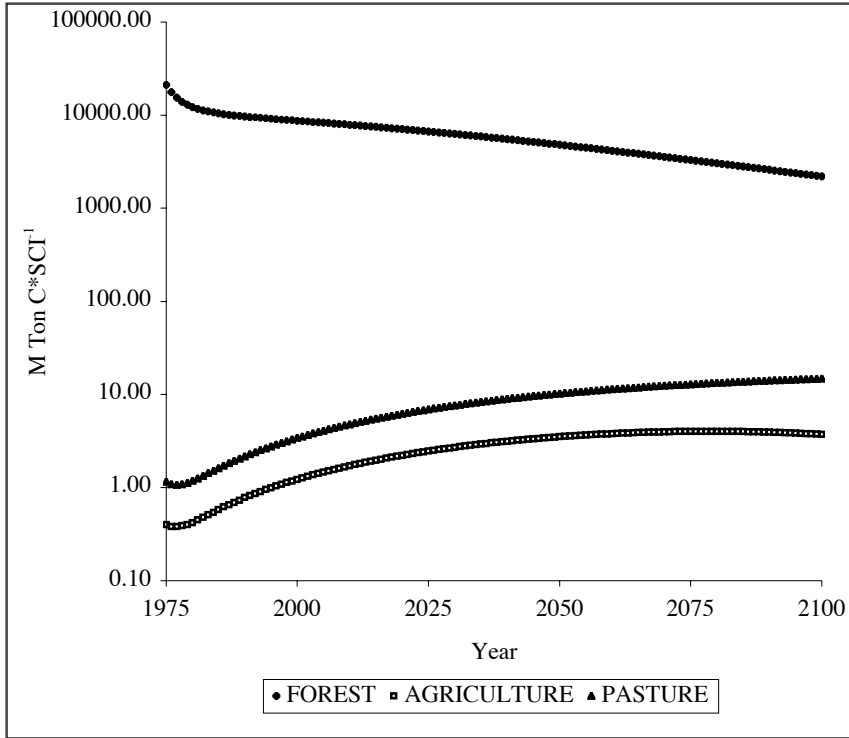

Figure 6.26. Recreation and Culture Service, Amounts /Forest and Main Land Uses

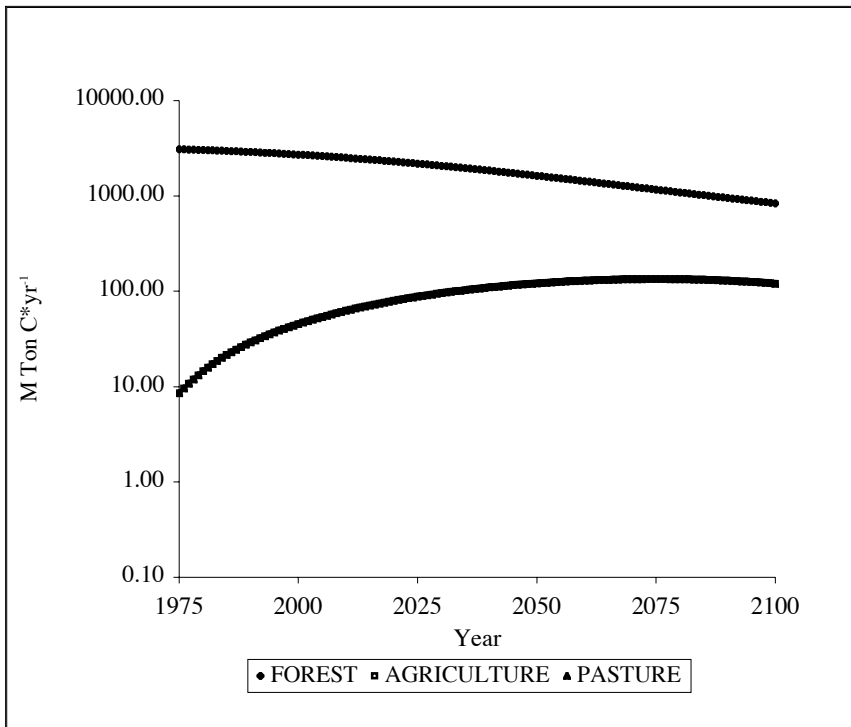

Figure 6.27. Gas Regulation Service, Amounts /Forest and Main Land Uses

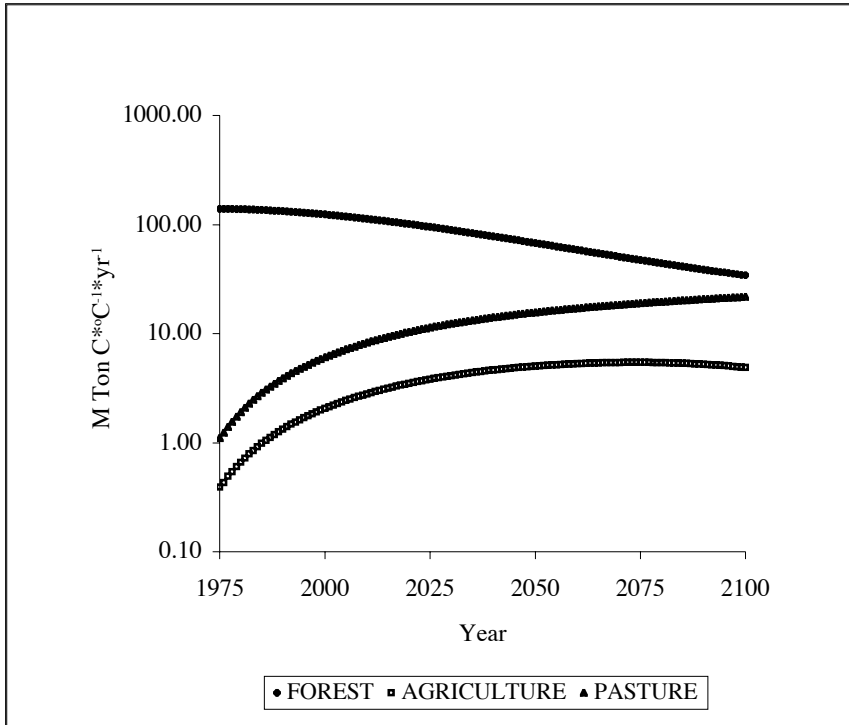

Figure 6.28. Climate Regulation Service, Amounts /Forest and Main Land Uses

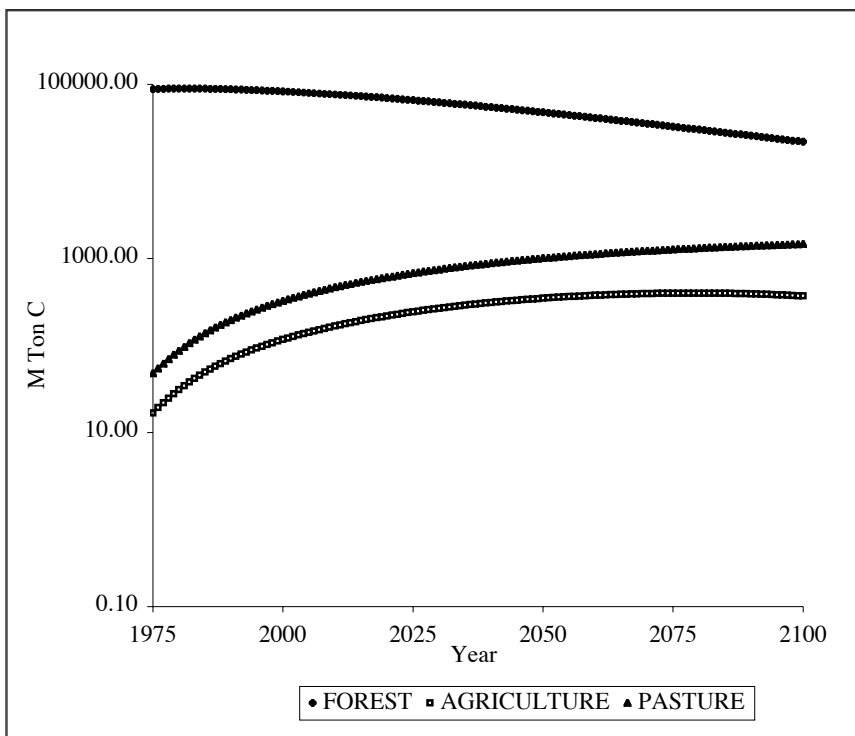

Figure 6.29. Disturbance Regulation Service, Amounts /Forest and Main Land Uses

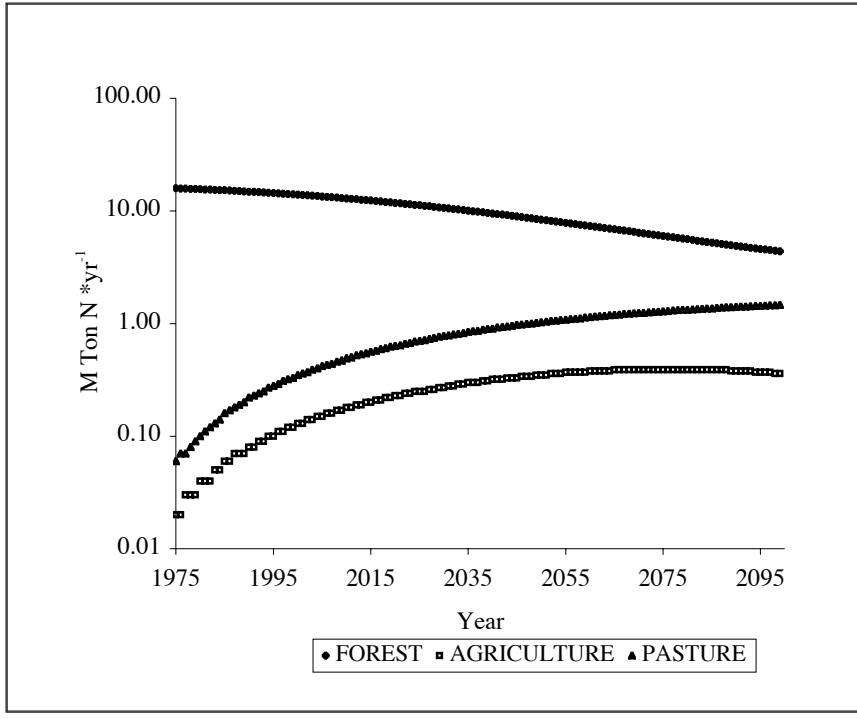

Figure 6.30. Plant Nutrient Uptake Service, Amounts /Forest and Main Land Uses

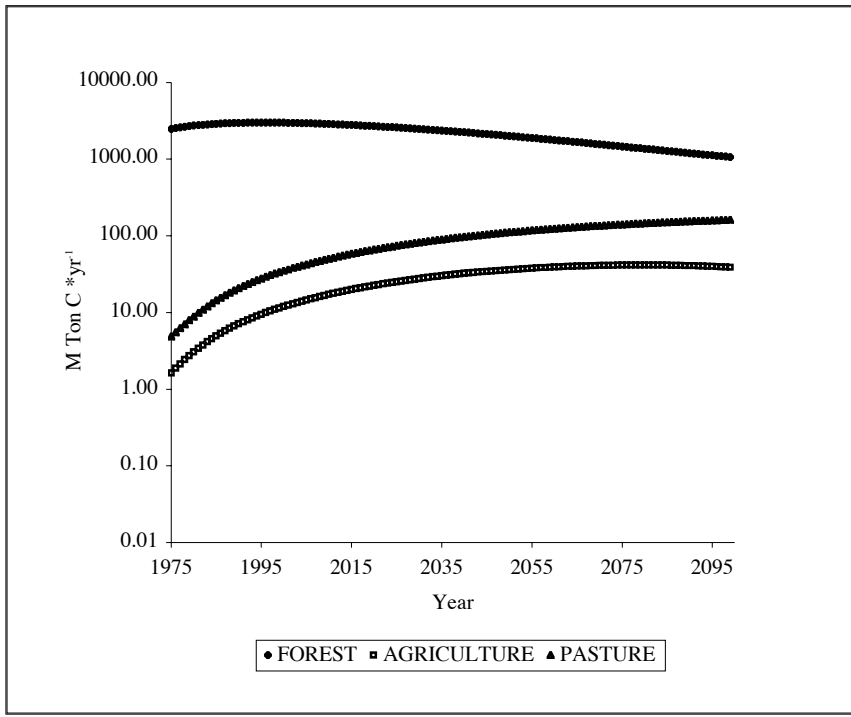

Figure 6.31. Organic Soil Formation, Amounts /Forest and Main Land Uses

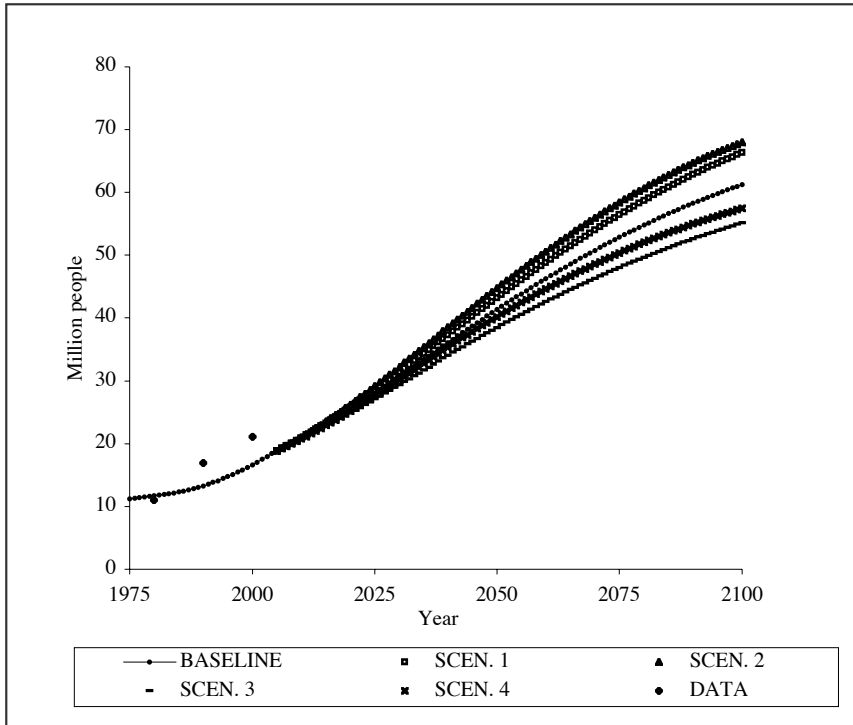

Figure 6.32. Amazon Population.

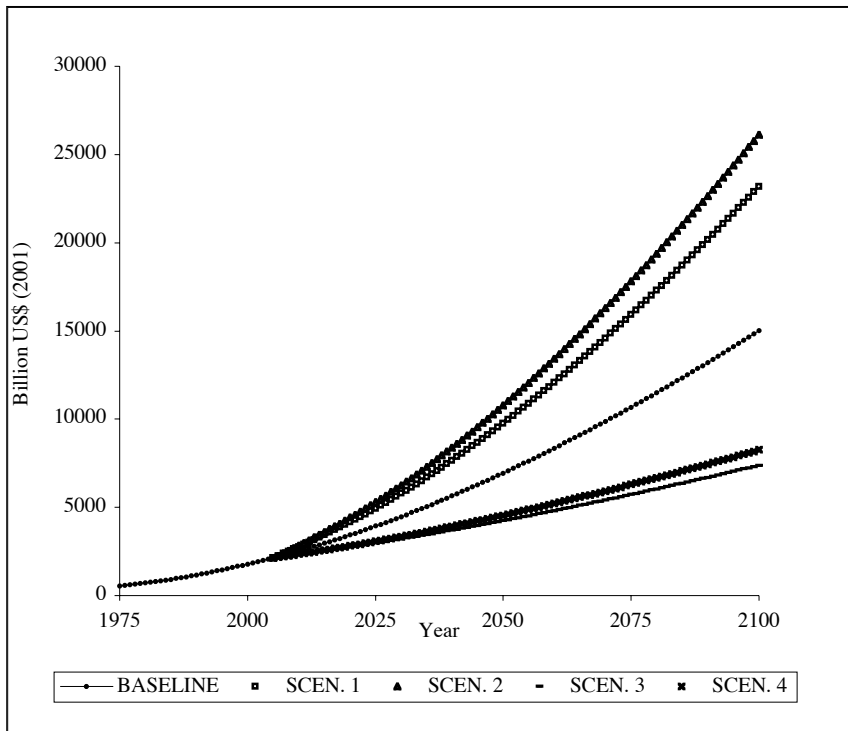

Figure 6.33. Built Capital.

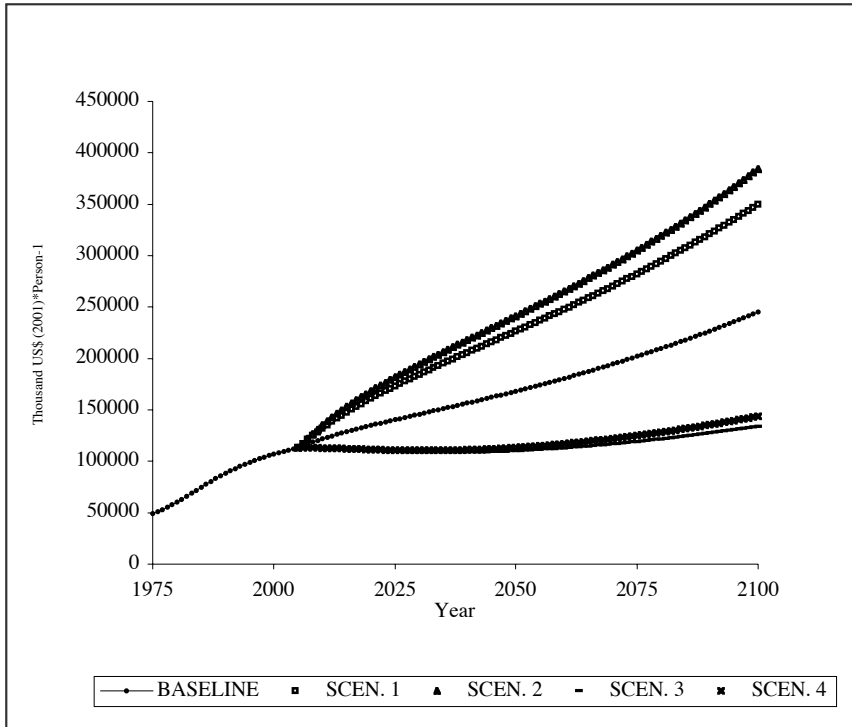

Figure 6.34. Built Capital per Capita

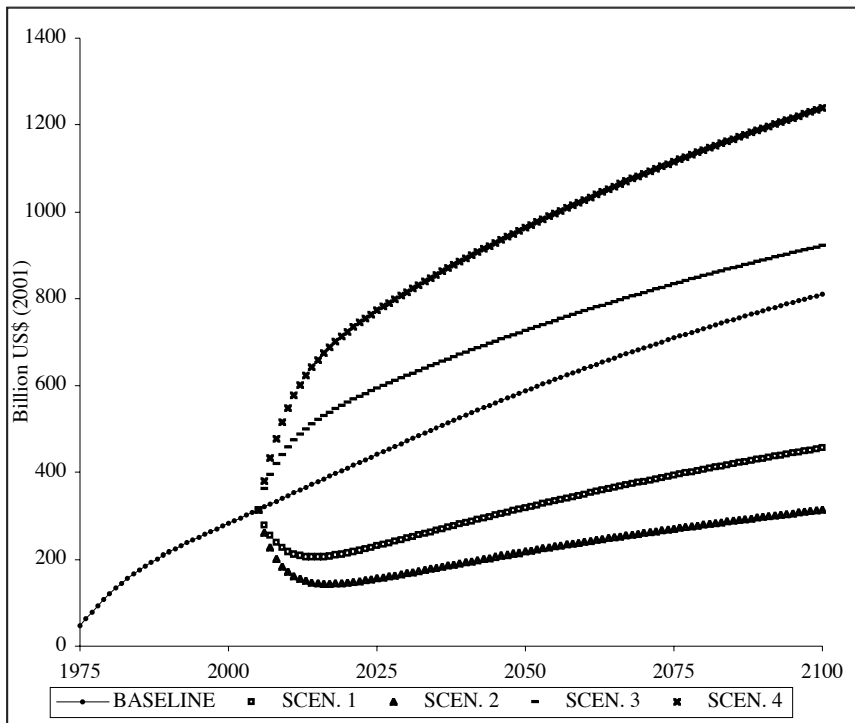

Figure 6.35. Knowledge.

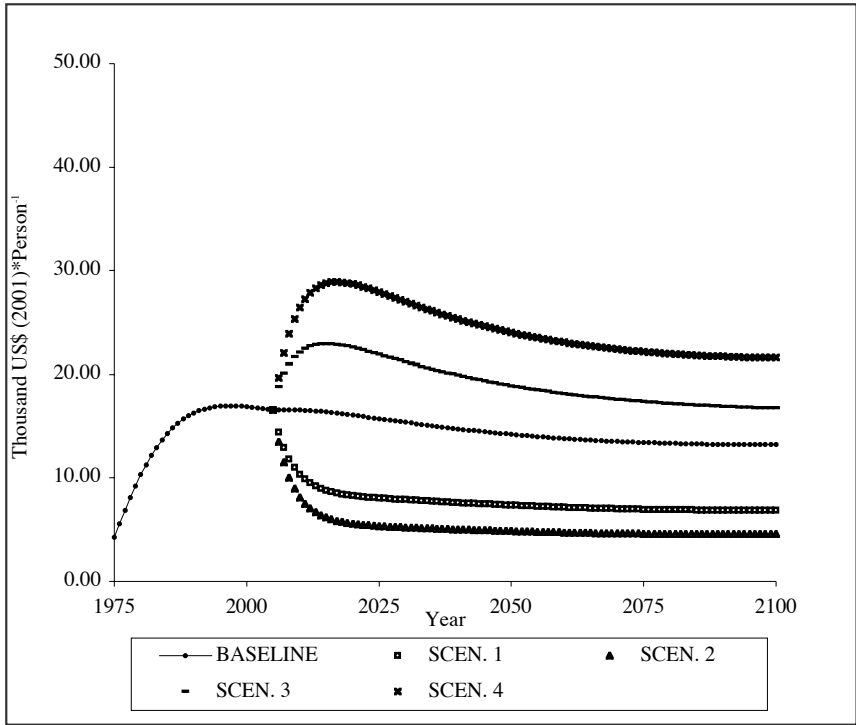

Figure 6.36. Knowledge per Capita.

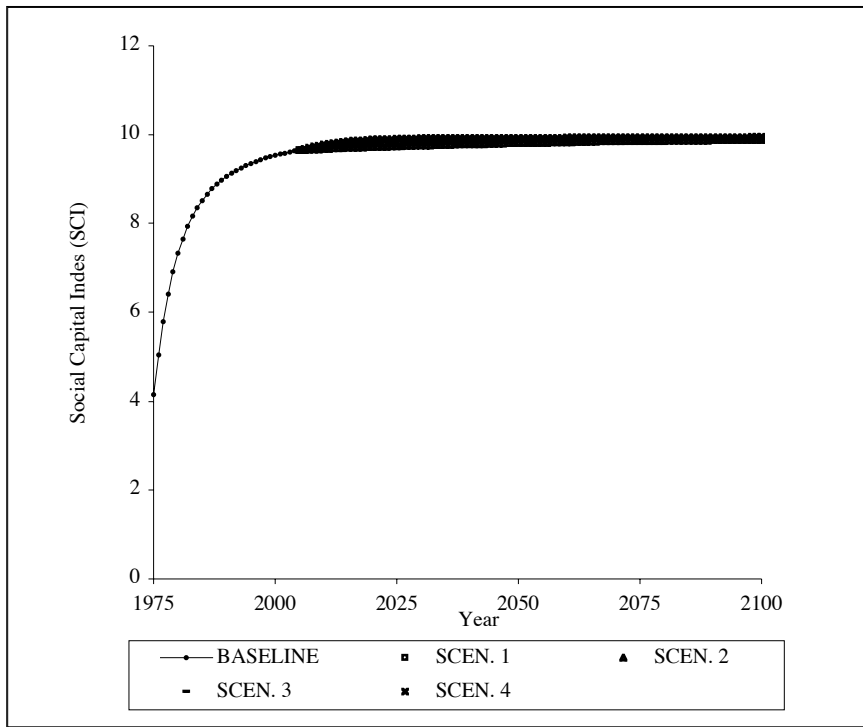

Figure 6.37. Social Network.

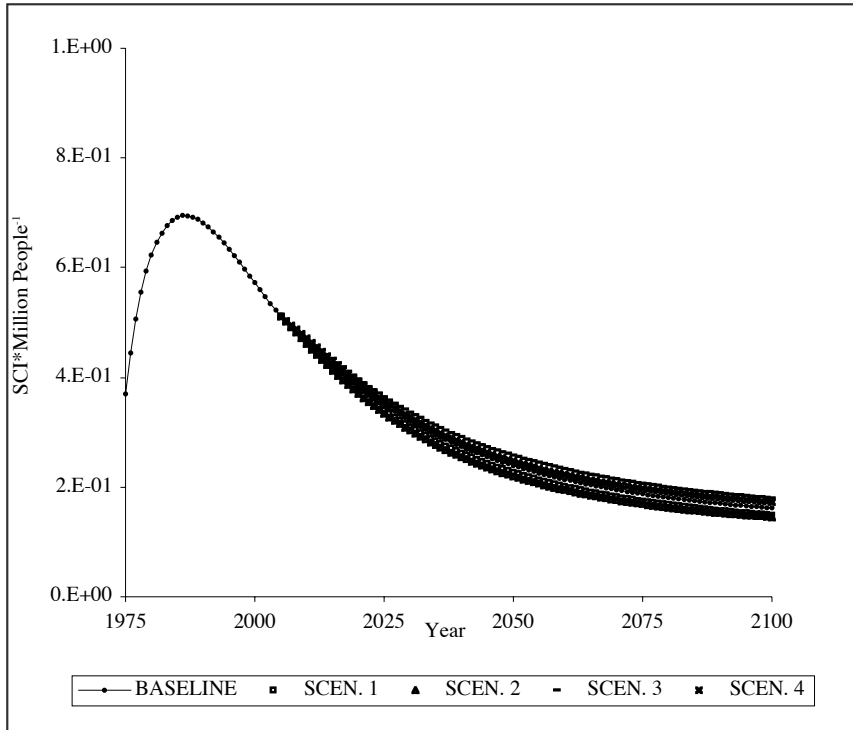

Figure 6.38. Social Network per Capita

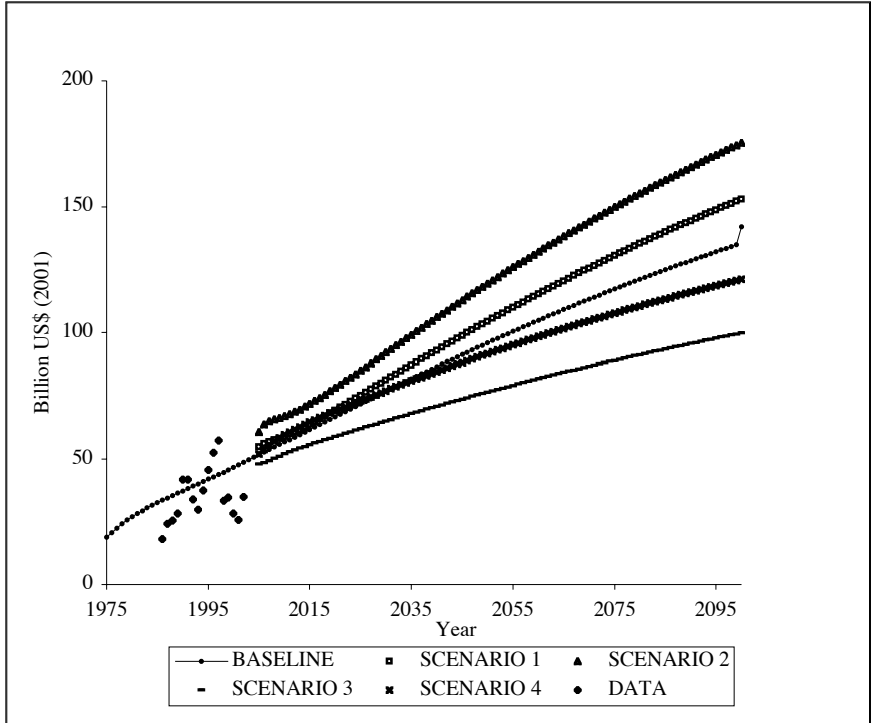

Figure 6.39. Gross Regional Product.

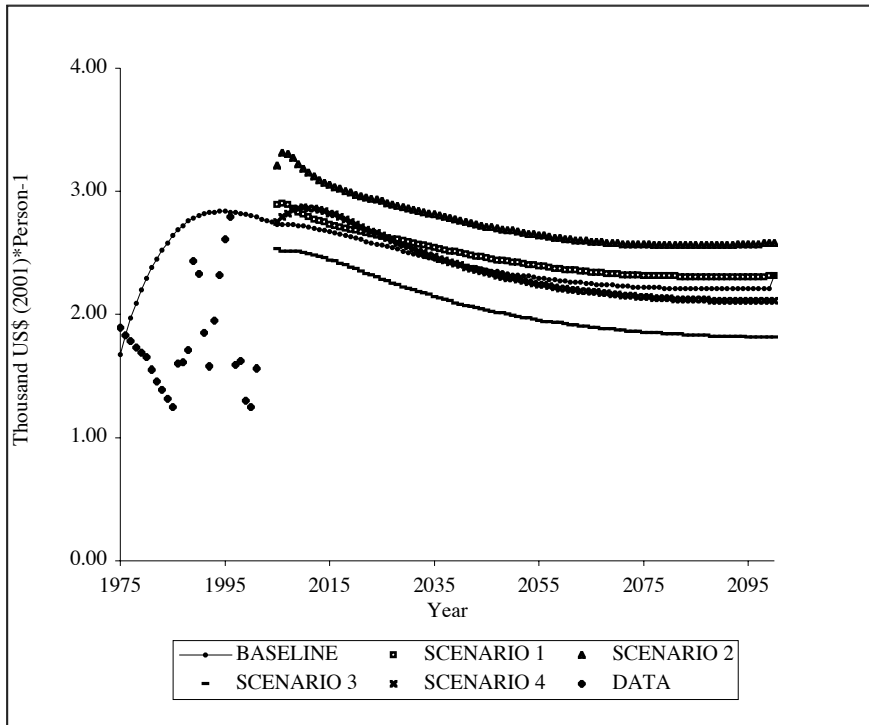

Figure 6.40. Gross Regional Product per Capita

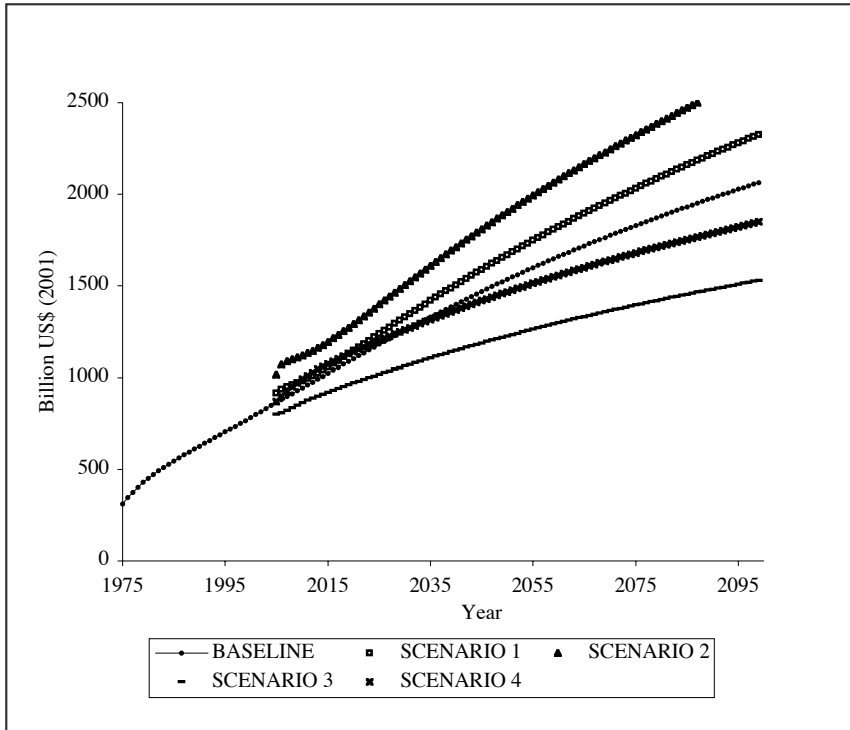

Figure 6. 41. Goods and Services Economic Production

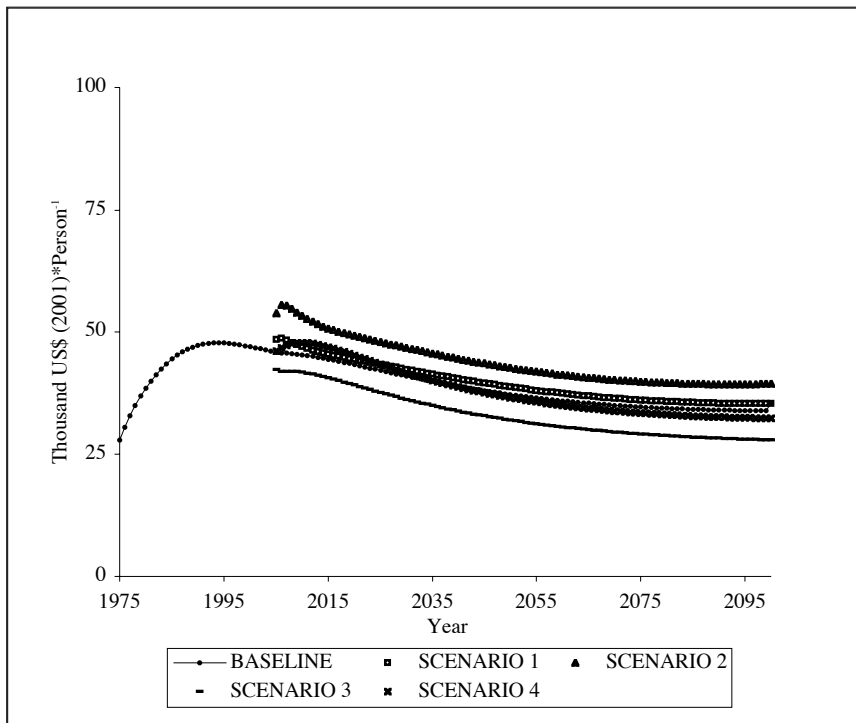

Figure 6.42. Goods and Services Economic Production per Capita

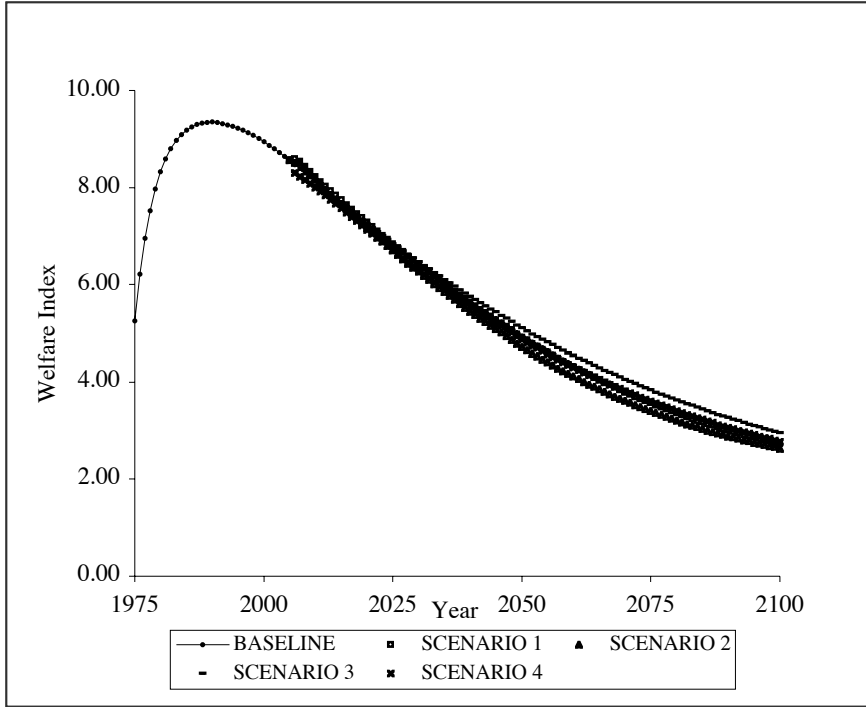

Figure 6.43. Regional Welfare.

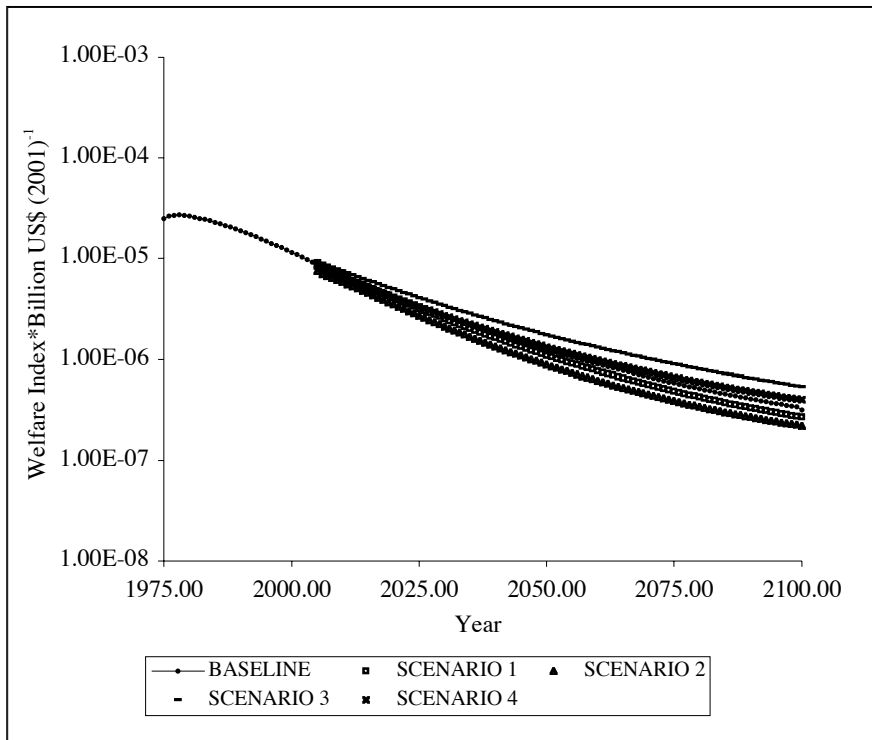

Figure 6.44. Welfare per Gross Regional Product.

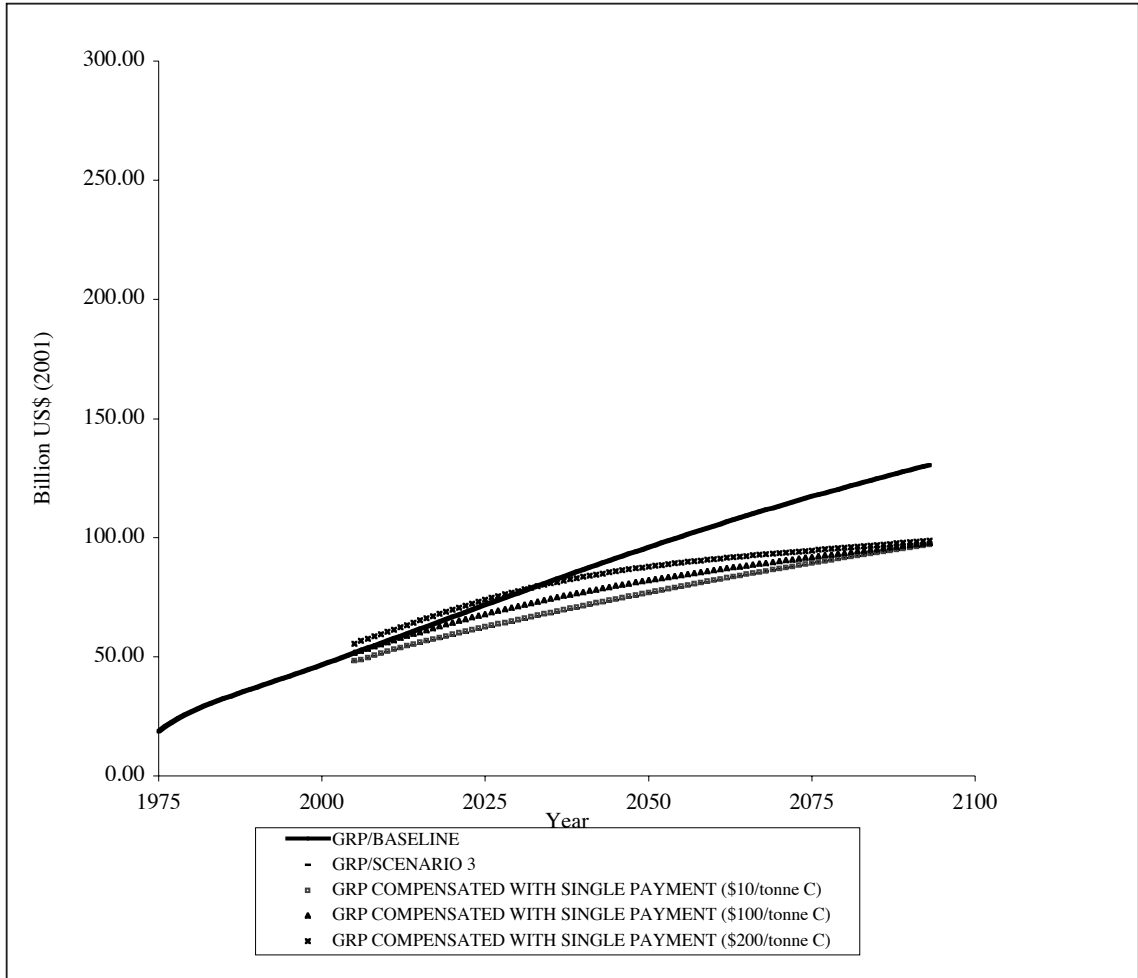

Figure 6.45. GRP with Monetary Compensation for Avoided Emissions of C as a Result of Implemented Scenario 3 under Different Market Prices per tonne of C and for a Single Payment.

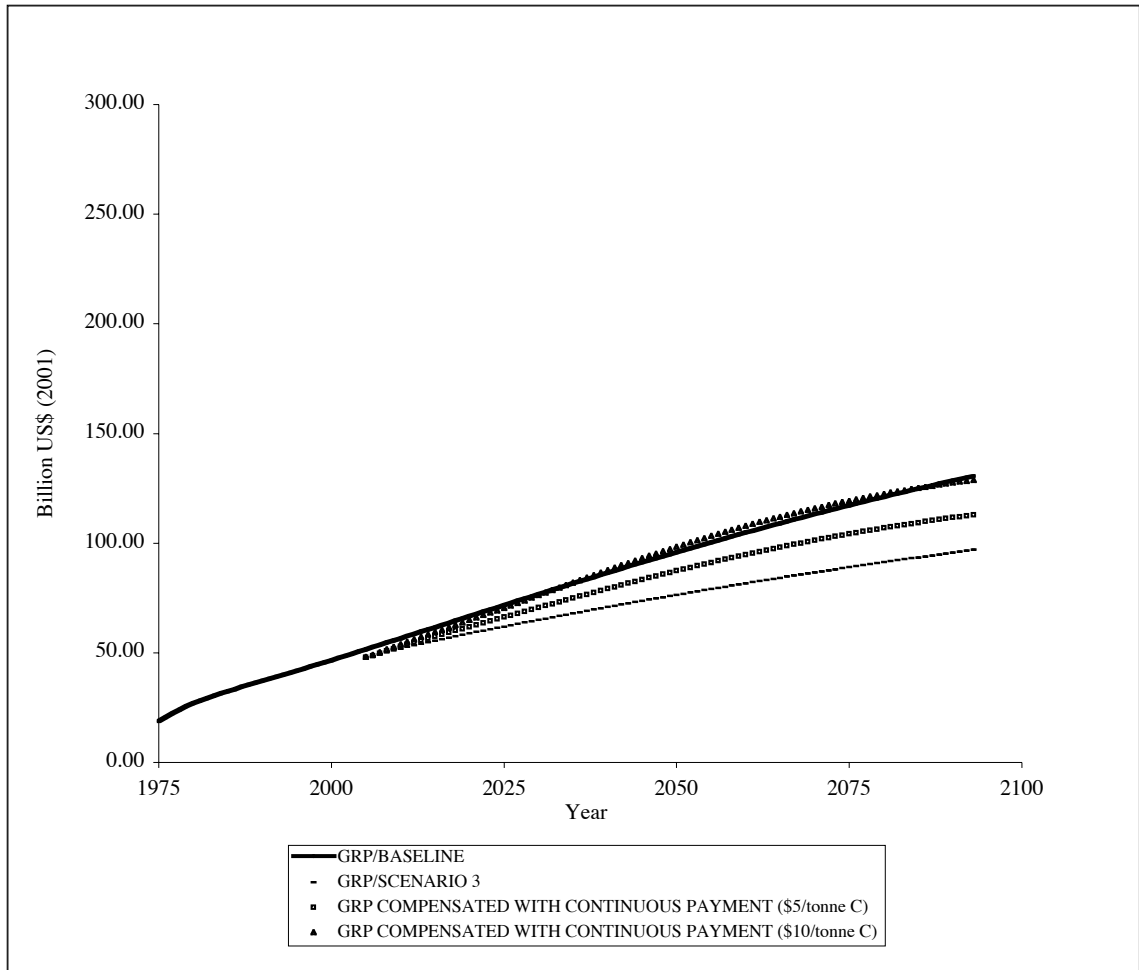

Figure 6.46. GRP with Monetary Compensation for Avoided Emissions of C as a Result of Implemented Scenario 3 Under Different Market Prices per tonne of C and for a Continuous Payment.

Chapter 7. Discussion

7.1. Deforestation and Economic Growth of Brazilian Amazon

Results of RUMBA suggest a rapid conversion of the Brazilian Amazon forest into pasture and fallow land for this century under business as usual scenario. Most shocking, however, is that while scenarios of increasing investment in natural capital yield lower annual deforestation rates than those of the baseline and of increasing investment in built capital, by the end of the simulated period remaining forest area under these scenarios is still very low when compared to initial conditions.

Given the strong trend of deforestation of the Brazilian Amazon under different sets of policies, such as simulated in RUMBA, one has to assess if the extent of forest loss by end of the simulation is really possible, in other words, if such a pessimistic scenario could actually be realized. Recent models of deforestation of the Amazon taking into account both current and planned development trends point to a drastic forest loss for the next 20 years (Laurance et al., 2001; Carvalho et al, 2001). RUMBA suggests that the deforested area in the Brazilian Amazon could be doubled by year 2025 from the current estimated 15% of the originally forest cover. These results are similar to results by Carvalho et al. (2001). The growth of Amazon's population simulated by RUMBA is also similar to those of a demographic dynamic systems model for the Brazilian Amazon's municipality on the period of 2000 to 2035 (Garcia et al, 2004). Since RUMBA results about the dynamics of land cover and population are consistent with other models, it is reasonable to conclude that the most likely scenario for the Amazon in the next 100 years is indeed one that will entail major changes in the forest.

Higher investments in natural capital would be preferable if you were to effectively protect the Brazilian Amazon. The model shows however, that higher investment in natural capital would lead to a lower GRP. For instance, while remaining forest area under a scenario of increased investment in natural capital (scenario 3) is nearly 20% higher than that of the baseline at the end of the simulation, GRP in that year as a result of implementation of such scenario is estimated at 30% lower than that of the baseline. This result, however, must be taken in light of an important caveat of the model: the lack of a distribution function that, for purpose of simplification, was not included in the model.

Distribution refers to the division of the economic output among people. A good distribution is one that is fair and just (Costanza et al, 1997). The reality of the Amazon, like that of Brazil, is taunted by an enormous inequality, precluding a fair distribution of the economic growth of the region among its population. Indeed, the high GINI index for the states of the Amazon region-- estimated at about 0.60, is an important indicator of that high degree of inequality (Lentini et al., 2003). Another compelling indicator of inequality in the Amazon is the degree of land ownership that is concentrated in the hands of wealthy farmers. According to Cattaneo (2002) in the Brazilian North region, which includes a large part of the Legal Amazon, while small farms comprise 94% of the farm establishments, they account for only 30% of the share of total land area in the region. Large farms, on the other hand, while comprising less than 1% of the farm establishments, account for about 30% of the total land area⁷. As put by Daily (1996, p.

⁷ Farms are categorized as small farms (less than 100 hectares), medium (between 100 hectares and 1000 hectares), and large (more than 1000 hectares).

332, italics added), “*private property, when some own a great deal of it and others have very little, become the very instrument of exploitation rather than a guarantee against it*”. A consequence of the inequitable land tenure system, is that economic growth of the region is unlikely to provide relief from economic suffering for poor people in the region. As a matter of fact, economic development policies in the Amazon have historically favored the rich (Barbier et al., 1991). According to Hall (1986), “*during the past 20 years official development strategy for the region has been...almost exclusively directed at the expansion of corporate forestry, agricultural and, more recently, mining interests virtually irrespective of any negative social and environmental side effects*”. Today, competition for land and for exploitation of forest resources in a scenario of high concentration of land ownership on one side, and poverty on the other side, has led to violent confrontations between landless and large farm owners (Wood and Perz, 1996) and to an increasing number of assassinations of rural workers (Langevin and Rosset, 1999). A land reform addressing the inequality in land ownership in the Brazilian Amazon is therefore crucial to a fair share of regional development and social justice. It needs however to carefully consider the environmental implications of allocation of land to the regional agricultural frontier.

The second important result of RUMBA is the significant climatic impacts occurring as a result of removal of forest cover: reduced precipitation and evapotranspiration, higher temperature and carbon emissions. These results are also within the same range as of other climate models for the Brazilian Amazon, as described in Chapter 3. However, it is possible, and even most likely, that the simulated changes in these variables lead to impacts stronger than observed by RUMBA on the overall

biomass production of remaining forest and on its anthropogenic land, and as a consequence, on the economy of the region. If that will be the case, then it would also be conceivable that climate change could have a direct impact on the economy of the region, and an indirect impact on the process of forest clearing. These and other model limitations and caveats will be discussed later in this chapter.

7.2. Assessment of the Research Hypothesis

Assuming that the extent of forest loss as simulated in RUMBA is likely, then an even more crucial question is: are the levels of forest loss simulated in RUMBA desirable, both from the standpoint of people of the region as well as that of the world? In order to answer this question, I will address the hypothesis investigated in this research: 1) increasing land use change in the Brazilian Amazon, while incurring significant losses of ecosystem services, provides for increasing monetary income and welfare of people of the region; 2) in the absence of incentives from global beneficiaries, rational land uses at the local level lead to sub-optimal provision of these services from the global perspective.

According to the model, there is indeed a great loss of ecosystem services when a unit area of forest is converted into anthropogenic use. Provision of recreation and culture, gas regulation, climate regulation, disturbance regulation, nutrient cycling and organic soil formation by forest are significantly higher than those from cropland and pasture. Hence, forest conversion into anthropogenic land uses simulated by the model, in particular into agriculture and pasture, is accompanied by a tremendous loss of services.

The conversion of forest into human land uses is also accompanied by increasing economic growth of the Amazon region. Indeed, by the end of simulation of the baseline

scenario, GRP is nearly 7.5 times higher than at the beginning. High GRP has an important effect on the dynamics of land change conversion, which in turn, feeds back to generate an increasing GRP over time. Also, growth of GRP appears to be particularly sensitive to the overall extent of land use conversion, as can be observed by the alternative scenarios. Even when scenarios generate relatively small changes in the rates of deforestation relative to the baseline, a pronounced effect on GRP is observed as a result of such changes. In other words, slightly higher land conversion leads to significantly higher levels of GRP.

The model shows, however, that higher GRP does not translate into much higher GRP per capita. GRP per capita at the end of the simulation of the baseline is only 1.4 times higher than that at the beginning. A higher growth of simulated population relative to the simulated growth of GRP explains the lower increase in GRP per capita. For the different scenarios, higher GRP, derived from increasing investment in built capital lead to an obviously higher GRP per capita than that of the baseline or those derived from investment in natural capital. But in any scenario, GRP per capita at the end of the simulation remains lower than 1.5 times that of the baseline at the beginning of simulation. That small increase in GRP per capita in all simulated scenarios is compounded by the fact that GRP per capita does not reflect the well-known problems of distribution and inequality of Brazil, as pointed out earlier. As a result, it is conceivable and even very likely, that the economic growth associated with the current pattern of forest resource uses in the Brazilian Amazon will not contribute much to poverty alleviation.

Finally, and most importantly, regional welfare, which increases for the first few years of simulation, undergoes a major decrease after that period, despite the economic growth experienced by the region over the simulated time. Welfare – a function of individual preferences of consumption and of built, human, social and natural capitals – appears to be particularly affected by loss of forest over time. This can be also observed in the higher values of welfare in scenarios of increased investment in natural capital. In summary, while it is true that current process of forest conversion incurs great losses while generating substantial economic growth for the Amazon region, forest conversion does not, as a general rule, provide for significant increase in monetary income as measured by GRP per capita. It also does not provide for increasing regional welfare, as measured by the welfare index. For these reasons, the primary hypothesis of this dissertation is rejected: increasing land use change in the Brazilian Amazon incurs significant losses of ecosystem services without this being adequately offset by increasing monetary income or welfare of people of the region.

In order to test the secondary hypothesis, I weighed the gains to the regional economy from forest conversion into anthropogenic uses against the losses associated with emissions of carbon from forest conversion, comparing scenario 3 with the model baseline. During the simulated period, an estimated 210 thousand km² of forest is spared from deforestation and about 3.0 Pg of C are not emitted to the atmosphere when scenario 3 is compared to the baseline. An estimated cumulative economic growth of US\$1.7 trillion is foregone as a result of the implementation of scenario 3 in comparison with the baseline scenario. These estimates are based on sum of all gains and losses over the 2005 – 2077 period. The high volume of avoided emissions simulated under those conditions-

of the same level as current annual global emissions from fossil fuels-points to deforestation leading to a sub optimal provision of forest services of gas regulation at the global level.

Analysis of the compensation mechanism has shown that a single compensation for avoided emissions (i.e. compensation that is done for the avoided emission on a given year based on current market value of US\$ 10 per tonne of C) is very low, having little impact on the economy. Therefore, such compensation is unlikely to represent any significant incentive to avoided deforestation. Only much higher prices per unit of carbon would significantly improve conditions for this option. In the model, this value is estimated at about US\$200 per tonne of C. Furthermore, instead of a compensation based on a single payment for avoided carbon emissions, a continuous compensation over time is preferable, as it gives a continuous incentive not to deforest. However, note that the relatively high payments that would, based on my model, still seem to be required to have a significantly reduced rates of deforestation without loss of GRP are in significant part due to the rather pessimistic assumption that each hectare is as likely to be deforested in the subsequent year and over time. In reality, it is quite possible and even likely that the risk of a patch of forest being cleared would diminish over time. If this would indeed be the case, the deforestation baseline would not be as pessimistic over time as in RUMBA due to its necessarily simplifying assumptions suggests. A variation of this approach is the type that a commercial contract between a landowner and purchaser of carbon credits would most likely have, although the purchase term would likely be much shorter (max.20-30 years) than the time horizon of the scenarios described in the RUMBA.

A continuous compensation over time at market price of \$10 per tonne of C, on the other hand, would be ideal for improvement of the economy of scenario 3, taking it slightly above the baseline scenario. A continuous compensation entails annual payments for the avoided emission from the time it is estimated as avoided to the remaining simulated period (e.g. until 2091). Even a payment based on half the current market price would still improve conditions significantly. For the purposes of comparison only, I will discuss the net present value of these compensations under the assumed different market prices, conditions of payment and discount rate. However, note that the use of discount rate and its implication that the present value of a future benefit (or loss) is less than its future value, is not endorsed in this dissertation. Furthermore, it has not in any way, been used in the dynamics simulated in the model.

The present value of C for the single payment investigated above, assumed as \$10 per tonne of C (NPV), would represent a continuous payment of only \$0.3 per tonne of C if the interest rate is estimated at 3%. In contrast, the continuous payment of \$10 per tonne of C every year would represent a present value of \$333 T of C (NPV) under the same interest rate. In essence, under the conditions simulated in RUMBA, an ideal compensation would require a present value of \$333 per tonne of C compared to current \$10 per tonne of C. Current prices in the emerging carbon market, however, are ranging from \$2 to \$6.00 per tonne of CO₂e (or ca. \$8 to \$24 per tonne of C) depending on the type of project and various terms and conditions of the commercial agreements (Lecocq, 2003). In comparison, my estimate of the continuous compensation price under ideal conditions as simulated in the model is \$83.3 per tonne of CO₂e.

Therefore, it is unrealistic to expect the carbon market alone – a market that is only now emerging – to compensate landowners for all the opportunity costs associated with forest conservation and for its continuous provision of ecosystem services. This limitation should not be used to completely write off the importance of the nevertheless ground breaking role of carbon offset projects in creating a new global ecosystem service market: payment for the sequestered carbon or avoided emissions of forest-based climate mitigation projects can represent an important contribution to better management of forest resources. If efficiently and effectively directed, such payments can help protecting important habitats, assist host countries in socio-economic development and provide a cost-effective means to reduce emissions.

Forest services are public goods and as a result, subject to a failure of the market to reflect their economic value. Their public good nature implies no possibility for one to preclude someone else from using it (non-exclusiveness), and use by one leaves no less for others (non-rivalry). Furthermore, the overall ignorance of most people of both the ecosystem service benefits in general, as well as of the potential impact on regional and global economies and human livelihood of approaching threshold levels in their provision, contributes to lack of economic incentives for conservation of forest services. Finally, protection of ecosystems yields benefits that go mostly to future generations, which is rarely taken into account in short-term economic decisions. The inability of markets to deal with environmental and social considerations in the provision of forest ecosystem services is only compounded by policy and institutional failures to prevent the large social costs of the losses in forest provision of ecosystem services that result from their exploitation for private benefits (Richards, 2000).

In the Brazilian Amazon, local decision-making prioritizing private, direct benefits from forest clearing is threatening the existence of the Brazilian Amazon forest and depriving society of important ecological benefits by an intact forest. Yet, as it was shown in this research, local (welfare derived from natural capital), and global social benefits (e.g. forest gas regulation and other services) from the forest are greater than the largely private benefits of deforestation. The non-existence of markets to translate the national and global demand for forest goods and services into income to land owners, the policy and institutional failures to intervene and to account for the social costs they incur is at the core of the problem of over-exploitation of forest.

In this research it has become evident that the significance of the emerging carbon market as an attempt to provide landowners with a compensation for the forest service of gas regulation is highly dependent on the price and form of payment. The overall conclusion is that in the absence of a compensation mechanism at levels estimated above – unlikely under current market conditions – forest land conversion will continue at levels that are above optimum from the global standpoint. The second hypothesis is therefore accepted with a modification: in the absence of significant incentives from global beneficiaries for any one ecosystem service, or a combination of incentives addressing several types of ecosystem services, rational land uses at the local level lead to sub-optimal provision of these services from the global perspective.

7.3. Alternatives for the Brazilian Amazon Continuous Provision of Ecosystem Services

One of the main assumptions of this research regards the continuous ability of landowners to clear forest for their private benefits, which is interpreted in the model as continuous risk of a patch of forest being cleared. In reality, this may not be the case.

According to a Brazilian federal legislation, a ‘legal reserve’ of 80% of forest must be kept in each property of the Amazon (Brasil, 1965; Brasil, 2001). However, despite the stringency of the Brazilian law, violations are common (Veja, 1999; Fearnside, 2003), mostly as a result of the limited ability of the government to enforce protection of the forest.

Effective enforcement is, however, possible. Experience has shown that, if implemented, a licensing and enforcement program for clearing areas based on remote sensing data may be not only viable but also very effective (Fearnside, 2003). If that will be the case, the implementation of a market-based mechanism to offset carbon emission and its potential benefits to conservation, should be assessed under a different set of conditions as the ones assumed in this study. For instance, one conceivable way that such carbon projects could influence the fate of the forest is by providing further financial support for governments to enhance enforcement or conservation of target areas of the Brazilian Amazon. Another alternative would be for carbon projects to be used as an extra incentive for landowners to keep their area of ‘legal reserve’ of forest. Should forest-based climate mitigation be approved for crediting under these conditions, their contribution to forest protection can be substantial. But it is important to note that to date, as pointed out in Chapter 2, the implementation of forest-based carbon-offset projects under the UNFCCC Kyoto Protocol has remained a highly contentious issue and one where consensus is yet to be achieved.

A potential alternative to protect the Brazilian Amazon forest is the recent ‘conservation concession’ concept developed by the Center for Applied Biodiversity Science at Conservation International (CI) in partnership with Harden & Gullison

Associates (HGA). A conservation concession is an agreement negotiated between an investor and a government or other resource owner involving a periodic payment in return for the conservation of a certain area (normally for 15 to 40 years), based on norms and guidelines that ensure a balance between conservation and development, and that take into account welfare of local stakeholders (Rice, 2003).

The conservation concession represents a market-based alternative in that it treats conservation as a product, and in that sense, one that may ensure permanent protection since agreements may be renewed indefinitely. Furthermore, by carefully considering the communities on the agreement, these concessions have been designed to contribute to their local livelihood without imposing risks to communities, such as unemployment and deterioration of their socio-economic conditions. Having negotiated a pioneering conservation concession with the government of Guyana, Peru and Sierra Leone, and with indigenous/community groups in Ecuador and Mexico, and currently negotiating many others potential agreements, CI is breaking ground in a potentially effective, efficient and equitable means of conservation. However, the limited direct incentives or benefits to the party paying for the conservation may prove a limiting factor to a more widespread application of this approach. Unlike the UNFCCC and in particular its Kyoto Protocol that have quantitative commitments and at least some forms of financing and enforcement mechanisms, there is a notable lack of similar quantitative commitments and financing and enforcement mechanisms in the UN Biodiversity and Desertification Conventions.

Finally, it becomes evident that it will take a significant concerted long term effort to protect the Brazilian Amazon and to overcome the prevailing ‘social traps’ associated

with the local, immediate payoff for resources use in region that are inconsistent with long-run and broader goals of society (Costanza et al., 1987). Quite obviously, this effort will require a combination of different types of measures such as a strong and protective legislation, effectively enforced through command and control regulations (CACs) with the flexibility allowed by tradeable development rights (TDRs). TDRs allow landowners to trade rights of development in areas designated for conservation that can be sold or exchanged for development rights on land outside restricted use areas. Efficient Market-Based Instruments (MBIs), in particular those addressing public good benefits such as payment for ecosystem services, carbon-offset trading, conservation concession, timber certification and fair trade (markets that account for ethical issues) may represent important incentives provided institutional barriers are overcome. Bioprospective deals, increasing secure property rights may be other important instruments. Proposed marketable forest protection and management obligations (FPMOs) under a global forestry agreement including clear global commitments and quantified targets for protecting or managing forests, if implemented, could also have an important impact in the protection the Brazilian Amazon as well as in other forests of the world (Richards, 2000). Last, but not least, international grant resources, in Brazil a significant source of funds for the protection of the Amazon (Laurance et al., 2001), remains a crucial part of the solution.

7.4. Model Limitations and Caveats

RUMBA is a unified metamodel, integrating several existing models at an intermediate level of complexity. As such, it includes necessary simplifications of many processes, which, when integrated, contribute to a quite dynamic and complex system.

Calibration for variables of the model, having an effect on all other variables, ensures internal consistency of the model and an overall realistic behavior, as can be seen from many crucial variables, such as land use, population, and GRP.

Like any other model, however, RUMBA is subject to many limitations. First, and foremost, because it is a non-spatially explicit model, this model relies on the use of average parameters for an otherwise extremely heterogeneous region. Secondly, it relies on significant assumptions to model processes that are poorly studied or documented, and for which consensus is yet to be achieved on appropriate indicators to describe such processes. For instance, despite the relative abundance of literature on the importance of ecosystem services to humans and their economy, to date there has not been a comprehensive study on indicators or proxies for their assessment. An important initiative is being undertaken by the National Center for Ecological Analysis and Synthesis (NCEAS) at the University of California, Santa Barbara, with the research project “ Understanding, valuing, and managing dynamic ecosystem services under stress: Synthesizing across the LTER Network”. This project, coordinated by Stephen Farber and Robert Costanza and with participation of scientists of many universities, is designed to “*develop understanding of the biogeophysical dynamics in stressed ecosystems and the implications of those dynamics for the valuation and management of ecosystem services and underlying ecological support systems*” (NCEAS, 2004, italics added) under a variety of LTER⁸. The ultimate goal of the research project is to provide gather and provide information that can support ecological management of different ecosystems.

⁸ Long-term Ecological Research program (LTER) is a collaborative effort established by National Science Foundation to investigate ecological processes over long temporal and broad spatial scales under 26 LTER sites representing diverse ecosystems and research emphases

A third limitation of the model is the linearly homogeneous production functions, such as the Cobb-Douglas production functions used in the model, which were simulated with constant returns to scale. Furthermore, the parameters used in such production functions (α_n and β_n) are constant for the simulated period. This, of course, is not the case in reality. In the real world, these parameters change to accommodate scarcity and individual preferences. Another limitation of RUMBA is the fact that because the model was designed to simulate overall trends, it does not account for stochastic episodic events, such as droughts and floods. This represents a limitation of the model, but is one of the many simplifications needed to integrate all different parts of the model.

Since this is a preliminary version of RUMBA, many improvements can be added to the model in the future. One such important improvement is to ensure a better sensitivity of the production limits of the biosphere sector to climate variables that are pointing to important changes over time. Another important improvement would address the ways in which economic production responds to such climatic changes and to decreasing stocks and natural capital of the region. A substantial, yet mostly challenging improvement to the model, would be the development of a distribution function that would simulate issues associated with inequality in terms of land ownership and income. Lastly, and most importantly, a detailed assessment should be done on the sensitivity of the economic sector of the model to the contribution of land uses cropland and pasture to the regional economy to rule out a potential over-estimation of that contribution.

Chapter 8. Conclusions

This dissertation uses a dynamic systems model to enhance understanding on the functioning of the Brazilian Amazon and to investigate long-term effects of current and alternative patterns of human uses of the forest. The Regional Unified Metamodel of the Brazilian Amazon (RUMBA), originally developed to run at a global scale, was adapted to run for the Brazilian Legal Amazon. The Legal Amazon is an area of approximately 5.0 million km², encompassing the areas of forest and savanna land as well as their anthropogenic uses. RUMBA contains more than two hundred state variables and nearly a thousand parameters that were used to integrate the dynamic feedback of ecosystem goods and services with patterns of land use change, economic production and human welfare in the Brazilian Amazon.

Main results of the best fit (business as usual) scenario of the model can be summarized as follows:

- Deforestation proceeds at high rates in the forest areas of the Brazilian Amazon. A massive loss of forest is observed this century, with only 26% of the original forest cover area remaining in year 2100. The majority of the deforested land is devoted to pasture, fallow and cropland land use.
- Significant climate effects of land cover conversion are also observed for variables such as precipitation and evapotranspiration – decreasing substantially over time – as well as for temperature and carbon emissions – increasing significantly over time.
- The provision of ecosystem services by land uses replacing the forest is significantly lower than that of the forest. The overall contribution of

ecosystem services to the regional economy is estimated to be about 5.0 times the value of the GRP in year 2100.

- Combined with increasing forest loss is the increasing economic growth of the region. High economic growth, however, is not translated into per much higher capita income, which increases only slightly during the simulation period. Regional welfare, experiencing an initial increase for the first 10 years of simulation, decreases significantly after that.

As a general rule, scenarios of increased investment in development yielded higher economic growth, which was accompanied by lower remaining forest cover, lower provision of ecosystem services, and lower human welfare when compared to the baseline and scenarios of conservation. Opposite trends were observed in scenarios of increased investment in conservation. Overall, the model showed a strong trend towards deforestation.

Analysis of the potential impact of a monetary compensation mechanism for avoided carbon emissions as a result of policies inducing conservation – such as those simulated in the scenario of increased investment in conservation – has shown that a single payment based on current carbon market prices has little impact on the economy. Hence, it is unlikely to represent any significant incentive to avoid deforestation. Results also show that a continuous compensation over time is preferable, as it both gives a continuous incentive not to deforest as well as pay s off some of the opportunity costs associated with implementation of such conservation policies. Since the estimated prices per unit of avoided emissions for both single and continuous payments were higher than current market prices, I conclude that it is unrealistic to expect the carbon market

alone to compensate landowners for all the opportunity costs associated with forest conservation and for its continuous provision of ecosystem services.

Main research findings can therefore be summarized as follows:

- Increasing land use change in the Brazilian Amazon incurs significant losses of ecosystem services without this being adequately offset by increasing monetary income or welfare of people of the region.
- In the absence of significant incentives from global beneficiaries for any one ecosystem service, or a combination of incentives addressing several types of ecosystem services, rational land uses at the local level lead to sub-optimal provision of these services from the global perspective.

Finally, it becomes evident that addressing the current destructive pattern of the Brazilian Amazon forest use will require a major effort that involves decision-making at the regional level – with support from national and international levels – and that entitles the region to an acceptable level of development. This effort will require a combination of different types of measures addressing market, policy and institutional failures to ensure that the benefits derived from short-term private local uses of the forest are consistent with long-term national and global social benefits of the forest and its provision of ecosystem services. The ultimate goal must be to protect the forest for this and next generations of people while maintaining sustainable benefits for local populations.

APPENDIX A: A Dynamic Model of Patterns of Deforestation and their Effect on the Ability of the Brazilian Amazon to Provide Ecosystem Services

“Reprinted from *Ecological Modelling*, 143, Portela, R., Rademacher, I., A dynamic model of patterns of deforestation and their effect on the ability of the Brazilian Amazon to provide ecosystem services, 115-146, Copyright (2001), with permission from Elsevier”.

Ecological Modelling 143 (2001) 115 - 143

A dynamic model of patterns of deforestation and their effect on the ability of the Brazilian Amazon to provide ecosystem services

Rosimeiry Portela and Ida Rademacher

^aInstitute for Ecological Economics, University of Maryland, Box 38 (1 Williams St.), Solomons, MD 20688-0038, USA

^bThe Aspen Institute, One Dupont Circle, Washington, DC, 20036, USA

Abstract

This paper presents a dynamic systems model that shows how different land use patterns degrade the value of ecosystem services provided by the Brazilian Amazonia. The model consists of four sectors: (1) Deforestation drivers, (2) Land use/cover, (3) Ecosystem services, and (4) Ecosystem valuation. The deforestation drivers sector models the economic and social incentives that small farmers and large pasture investors have for clearing the forest. The land use/cover sector shows how these different groups clear land, and further shows how patterns of forest succession and associated biomass differ by primary land use type. Different land use patterns greatly impact the quality and economic value of ecosystem services. These impacts are dealt with in the ecosystem services sector, which models the region's hydrological cycle, the nutrient cycle, carbon sequestration capacity, and species diversity. Calculations are made in the ecosystem valuation sector according to a reference monetary value for these ecosystem services. The model calculates the change in these values according to the land use practices that occur over time. Findings show that over a 100-year simulation, forest area remains about 44 percent of original area with pasture and abandoned pasture becoming the dominant land cover. The value of ecosystem services declines from \$1431 per hectare per year to \$658 and \$781 per hectare per year for agriculture and pasture, respectively. These findings are compared to annual income derived from different land use practices for which land was cleared in the Brazilian Amazonia. In the context of these findings, the authors discuss how an explicit monetary valuation of ecosystem services could create positive incentives for land stewardship and conservation.

1. Introduction

Massive deforestation in Brazilian Amazonia, the largest continuous region of tropical forest in the world, is known to have profound effects on the forest's biological diversity, resilience to disturbance, soil and water resources, and regional and global climate patterns (Crutzen and Andreae, 1990; Dale et al, 1993; Dale et al., 1994; Fearnside, 1997b; Rocha et al., 1996; Salati, 1987; Salati and Nobre, 1991; Salati and Vose, 1984; Serrao et al., 1996; Shukla et al., 1990; Skole and Tucker, 1993; Zhang and Henderson-Sellers, 1996; Zhang et al., 1996; Wood and Perz, 1996). The economic benefits derived from deforestation of Amazonia come from extractive, productive, and speculative practices that are encouraged by the increasing infrastructural development of the region (Hecht, 1985). Some of the main activities include logging, mining, cattle raising, agriculture, construction of dams, roads, and urban settlements (Hall, 1986; Serrao et al., 1996). The pattern of forest exploitation is based on the utilization of resources with very little or no attention paid to the value of protected forests in providing ecological functions such as biodiversity maintenance, carbon storage, nutrients cycling and erosion control (Fearnside, 1997a). The neglect of these goods and services is not puzzling given that most individuals who exploit the resources of the Amazon do so for monetary gain and nature's services are primarily non-market – and hence non-priced - goods (Faminow, 1998). The neglect is distressing, however, especially in the case of vital life support functions such as gas and climate regulation. These ecosystem services have been tremendously affected by the last few decades of clearing (Fearnside, 1996, 1997b).

In the model discussed here the authors focus primarily on deforestation that is driven by productive and speculative purposes. The purpose of the model is to understand at a very broad and aggregated level the toll that these patterns have exacted on the ecological functions and ecosystem services provided by Brazilian Amazonia. In an effort to find meaningful ways to discuss the importance of ecosystem services for sustained economic activity, the loss of services observed in the model due to ranching and farming land use practices is translated into an annual monetary value that can be compared to the annual revenue generated by ranching and farming activities.

1.1. Study area

The area of study consists of the Brazilian Amazon's river drainage basin, an area of approximately four million square kilometers, encompassing the states of Acre, Amapa, Amazonas, Maranhao, Mato Grosso, Para, Rondonia, Roraima and Tocantins. Historically, this area has been primarily forested, but this is changing as land is submitted to an intense process of deforestation that started in the 1970s as a result of governmental policies designed to settle the region and exploit its natural resources. Government investment in road construction and new settlements began on a massive scale in order to alleviate population pressure in the Brazilian Northeast, strengthen Amazonian borders and enable access to the region's vast supply of resources (Pyne et al. 1996). Government-financed programs and subsidies encouraged extensive cattle ranching, farming and logging (Moran, 1991; Moran et al., 1994; Laurance et al., 1998b) along the newly created roads, especially on the southern and eastern fringes of the basin, where vast areas have been cleared and converted to pasture (Uhl et al., 1988). According

to Eden et al. (1990), Fearnside (1996, 1997b), Neill et al. (1997), Walker et al. (2000) and Uhl et al. (1988) cattle ranching activities continue to account for most of the deforestation in the Brazilian Amazonia.

Recent data on the extent of this deforestation shows that about 13 percent of the Brazilian Amazonia Forest has already been cleared, and that the annual rate of deforestation in the last twenty years varied between 0.30 percent and 0.81 percent (INPE, 1998). In terms of area, this is equivalent to low values such as the 13,020 km² deforestation occurring in 1978 to the high rates of 29,160 km² in 1986 (ibid.). At the current rate of deforestation and with large areas yet to be cleared, an increase in the severity of the ecological and climate effects is expected (Fearnside, 1997b).

2. Methods

The model uses the STELLA programming language (High Performance Systems 1993) to explore the farming and ranching uses of the Brazilian Amazonia and the effects these practices have on ecosystem services and functions. The model is highly aggregated and construction involved the elaboration of non-spatially explicit socioeconomic and ecological processes and patterns. The resulting dynamic model contains important linkages and feedbacks between human activities and ecological impacts. Links and relations between and within the different sectors of the model were developed by establishing direct and indirect connectors between state and auxiliary variables. Equations and random numbers were employed to describe some expected behaviors that are well documented in literature. Data used in the calibration of the different processes were collected from many publications and were important in

checking the behavior of different sectors of the model. While some parts of the model such as ecosystem service values could not be calibrated using published quantitative data (because none could be found in the literature), there was a substantial amount of qualitative data that was used to inform all aspects of model construction. Although each aspect of the model was carefully researched, it is important to keep in mind that all results are experimental and highly aggregated. They are offered merely as a starting point for further discussion and research aimed at finding useful ways to describe the damage that is done when public goods are not valued privately in decision-making processes.

3. Model Description

A dynamic simulation model was developed in order to investigate the effect of different patterns of deforestation of Brazilian Amazonia on the area's ability to provide ecosystem services. Figure 1 shows a model overview with its major sectors. In the model, deforestation is driven by socioeconomic processes laid out in the deforestation drivers sector. Smallholders and ranchers have multiple economic and social incentives to clear land. Economic gain comes from both productive and non-productive (i.e. speculative) uses of land, and can vary due to fluctuations in the economy, ability to gain clear title to land, and access to markets.

While some incentives to clear are similar for farmers and ranchers, the patterns of clearing and land-use intensity are markedly different. These differences are reflected in the land-use/cover sector. This part of the model deals with transition rates between productive farm and pasture, degraded pasture, and secondary regrowth. The different

land use patterns and land-cover change processes alter a variety of ecosystem properties, the most important of which is vegetation cover (biomass).

The effects of biomass changes are modeled in the ecosystem services sector, which includes hydrology, erosion, nutrient cycling, carbon storage, and species diversity processes. The ecosystem valuation sector relates the changes that occur in the ecosystem services sector to monetary values using the values calculated by Costanza et al. in the 1997 publication “The value of the world’s ecosystem services and natural capital.”

Graphs of model behavior and tables displaying model results are presented using the user interface capabilities of STELLA. Using this interface, one can alter many of the assumptions that are used to construct the model in order to build different scenarios about deforestation, transition rates and economic activity.

3.1. Deforestation drivers sector

This model sector is shown in Figure 2 and it depicts basic social, demographic and economic processes that have been researched and found to be significant factors in Brazilian Amazonia deforestation (Fearnside, 1987, 1993; Mahar and Schneider, 1993; Moran, 1991; Hecht, 1993; Pfaff, 1999; Monbiot, 1993; Wood and Perz, 1996). The purpose of including these factors in the model is to show in an explicit way that deforestation is largely the result of a socioeconomic process (Dale et al., 1993). By including the human dimension of deforestation in the model – even in a simplified and stylized context – it is possible to communicate something about the linkages that exist between socioeconomic and ecosystem processes, and to begin to explicitly identify the

losses in ecosystem services that are directly attributable to certain types of economic activity.

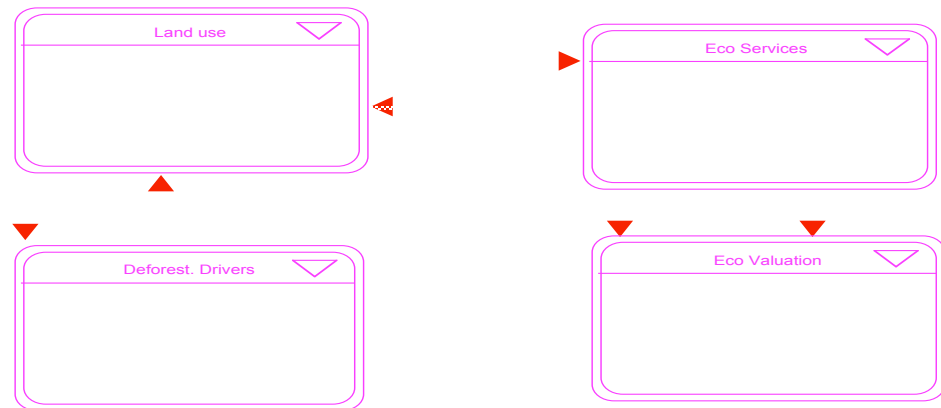

Fig. 1. Model overview.

The model accounts for clearing by new farm and ranch start-ups as well as clearing by existing establishments. Two main processes combine to determine deforestation by new Amazonia farms and ranches - economic incentives and population growth. Economic incentives include economic trends and infrastructure development. An economic trends index was designed to roughly mirror the highly fluctuating Gross

National Product of the Brazilian economy and was calibrated to existing GNP data for Brazil.

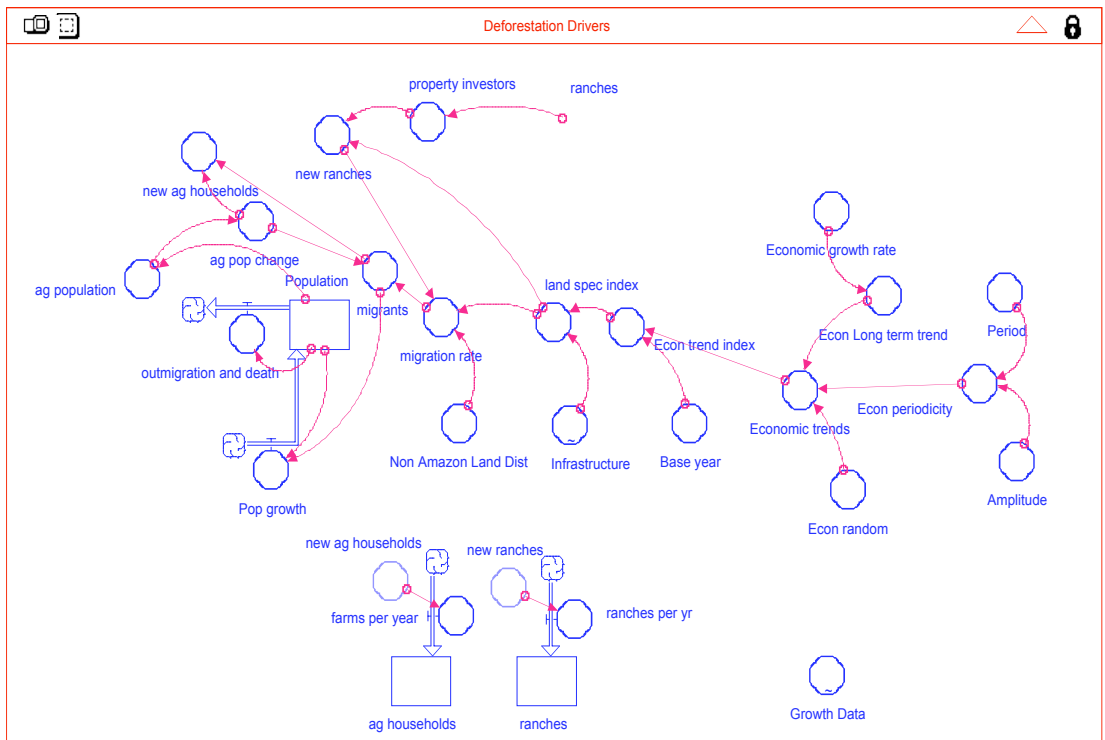

Fig. 2. Deforestation drivers sector.

The economic trends consist of a an economic long term trend that assumes growth over the long run for the Brazilian economy, and an economic short term trend that assumes that there will periods of economic expansion and recession over shorter time spans (15 years). Infrastructure refers to the density of roads in the Amazon. The infrastructure

element of the submodel represents “infrastructure density” in Amazonia in graphical form. The relationship between the economic trends index and the infrastructure density is multiplicative and the two factors form a “land speculation index”. In this model, the index is intended to reflect the way that different incentives for development compound one another and influence the rates at which land speculation and clearing take place. The compounding factors of easier access and economic growth increase incentives for both ranch investment and migration to the Amazon.

The model assumes that the reasons for new ranch and new farm clearing are somewhat different. New Ranches are primarily a function of speculative investment, whereas new farm clearing is much more closely tied to factors such as the shifting nature of cultivation and political and economic conditions that drive population influx into the Brazilian Amazon (Hecht,1993). Population growth includes existing settlers and new migrants (migration is further influenced by land shortages elsewhere in Brazil – represented in the model as Non Amazon land distribution). The average amount of land cleared by new farms is initially set at 3 hectares (Fearnside, 1993). The average new ranch is set to clear 50 hectares (Fearnside, 1993). These clearing rates can be altered in the user interface of the model.

Much more land is cleared in a given year by existing ranches and farms than by new ones. Ongoing clearing rates are influenced by a clearing rate index. The clearing rate index is a function of the land speculation index, soil fertility (random – soil fertility is highly variable in the Amazon), erosion, and conflict. Conflict occurs between large and small landholders (and farmers and ranchers) in the absence of secure land tenure rights and title policies, and with increasing population density. Without working

property rights institutions, an unofficial “clear equals claim” policy drives farmers and ranchers to accelerate rates of deforestation.

Parameters were calibrated to generate clearing rates that are in line with those documented by INPE (1998). Roughly thirty percent of deforestation is estimated to come from agricultural (farm) clearing and 70 percent is attributed to pasture (ranch) clearing.

3.2. *Land-use/cover sector*

A land-use transition sector is shown in Figure 3a and Figure 3b. Figure 3a shows part of the sector that deals with the transition rates and Figure 3b shows calculation of biomass amounts in the land stocks. The transition rates were translated from Fearnside (1996), who used a first-order Markov model of transition probabilities between land-use categories to investigate carbon stocks in vegetation replacing the Amazon forest. Fearnside’s approach was particularly helpful for our model because it explored the fate of land being cleared by both small farmers and ranchers, according to their typical behavior in terms of pattern of use, averaged time of use and of subsequent regrowth. Average and constant transition rates were weighted for small farmers and ranchers and then used as rates of transition probabilities between the land use categories. Although not necessarily realistic, Fearnside (1996) considered these ratios useful for estimating average biomass characteristics in each category. These averages are conservative: in reality, many of the economic pressures described in the “drivers” sector of the model will force land to be used longer and more intensively, further reducing biomass. Figure

4 shows the schematic diagram of land-transition derived from Fearnside (1996) and employed in this model.

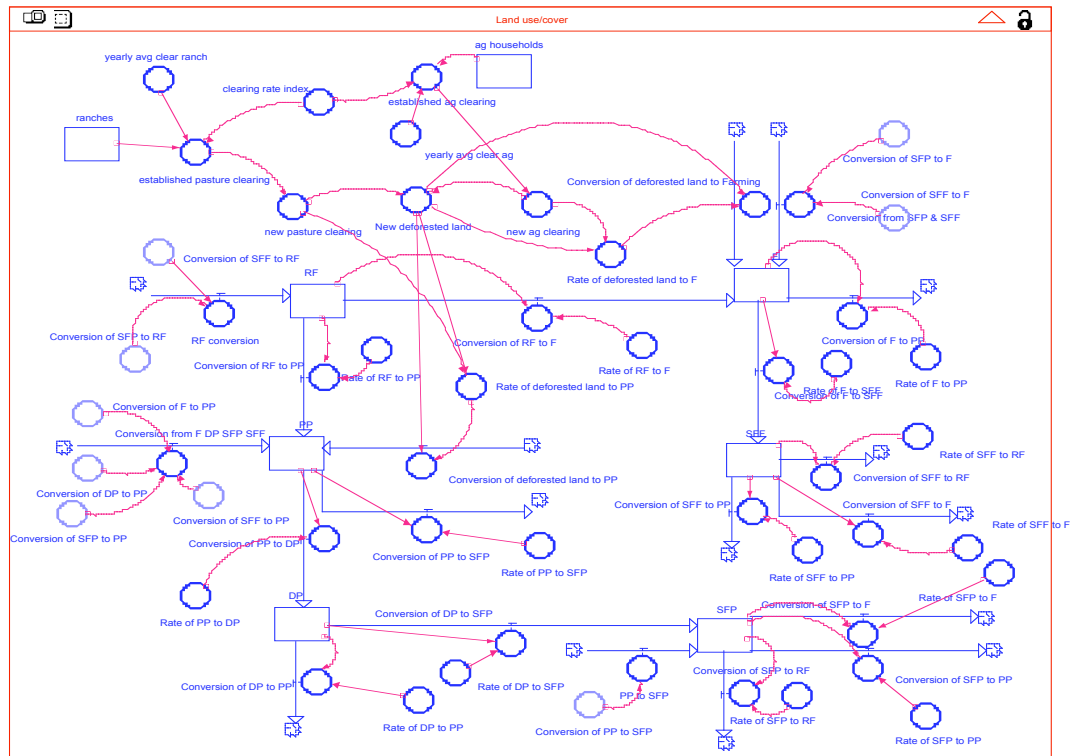

Fig. 3a. Land use/cover sector: transition rates.

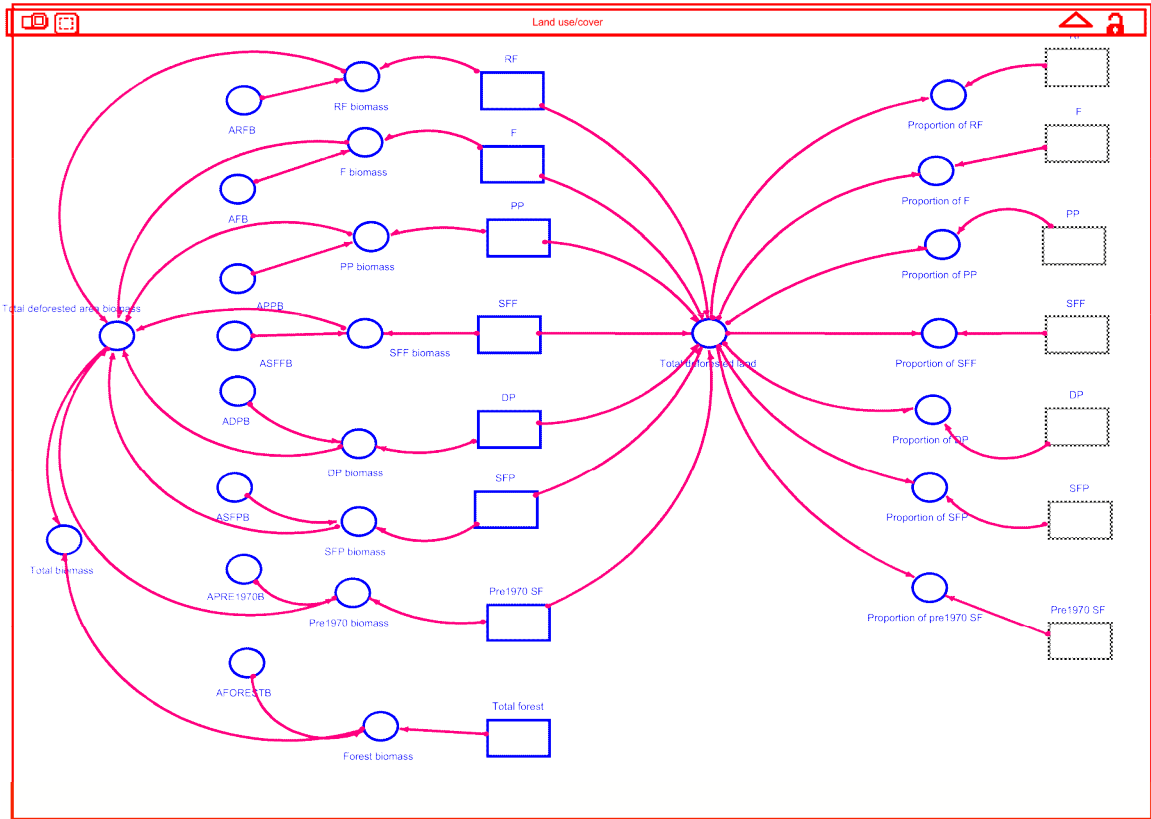

Fig. 3b. Land use/cover sector: biomass amounts.

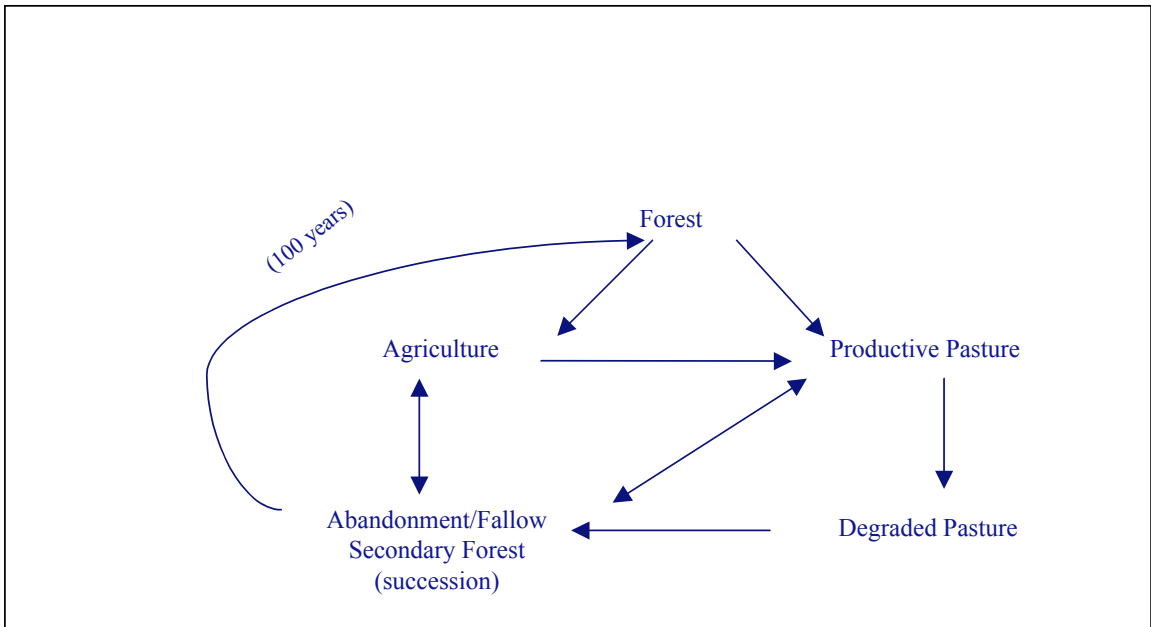

Fig. 4. Land use transition patterns.

We added to this transition model an annual flow of new deforested land derived from the deforestation drivers sector, which is a combination of new pasture clearing and new agriculture clearing. Over time, the model distributes the cleared land into the common categories found in the Brazilian Amazonia. The transition pattern begins with initial use as farmland (F) or productive pasture (PP), assumed in this model to correspond to smallholders and ranchers, respectively. Farmland transitions to either productive pasture or secondary forest (SFF). Productive pasture transitions into either degraded pasture (DP) or secondary forest from pasture (SFP). A small amount of secondary forest from farm and from pasture ends up in true succession to regenerated forest (RF). Most land, however, is continually transitioning between varying states of use and disuse (fallow), reflecting some of the true dynamics of land use in the Amazon. The transition values and state variables used in the model were estimated from Fearnside (1996), and approximate the land use dynamics that existed in the Amazon in 1990.

It is important to track different land-cover stocks in the model because different land use patterns greatly impact the quality and value of ecosystem services. One of the most important impacts of different land uses is their effect on biomass. High biomass productivity rates in the Brazilian Amazonia play a critical role in stabilizing and regulating ecological processes operating at local, regional and global scales. In the model, each land use stock was associated to average biomass properties according to a review of varying sources (Olson et al., 1983; Brown and Lugo, 1984; Uhl, 1987; Saldarriaga et al., 1988; Brown and Lugo, 1992; Fearnside, 1992a; Fearnside, 1992b; Chroeder and Winjun, 1995; Fearnside, 1996; Salomao et al., 1996; Cochrane et al., 1999). A user interface allows model users to adjust the biomass amounts in each stock to

account for the range of values found in the literature. The initial forest biomass settings were derived as average numbers that take into account estimations for dense and non-dense forests (Fearnside, 1992a). In the model, the assumption is made that vegetation is uniform across the basin. Biomass stocks play an important role in the ecosystem services submodel. Equations of land use transition (inflows and outflows rates), initial stock values, proportion of land in each category in relation to total deforested land, average biomass values and total biomass values and are provided in the Appendix A.

3.3. Ecosystems services sector

Ecosystem services refer to ecological conditions and processes that regulate and provide for human well being (Daily, 1997). This sector (shown in Figure 5) focuses on four primary ecosystem services that are provided for by an intact (i.e. forested) Amazonia region, and which contribute to human well-being on global, regional and local scales. They include climate regulation, erosion control, nutrient cycling and species diversity. Average ecological values for the assessed service and associated land use categories were derived from literature and are displayed in Table 1.

3.3.1. Climate Regulation

The Amazon is the largest stand of tropical forest left on the planet and as such, it is an important carbon sink that aids in the maintenance of global climate regulation. In the model, we estimated carbon storage capacity to be 45 percent of the value of biomass (Fearnside, 1996). Storage capacity drops as biomass diminishes under farming and ranching land-use patterns. The Secondary succession has a smaller storage capacity than mature forest (ibid.), mainly due to the loss of large, mature trees (Attiwill, 1994).

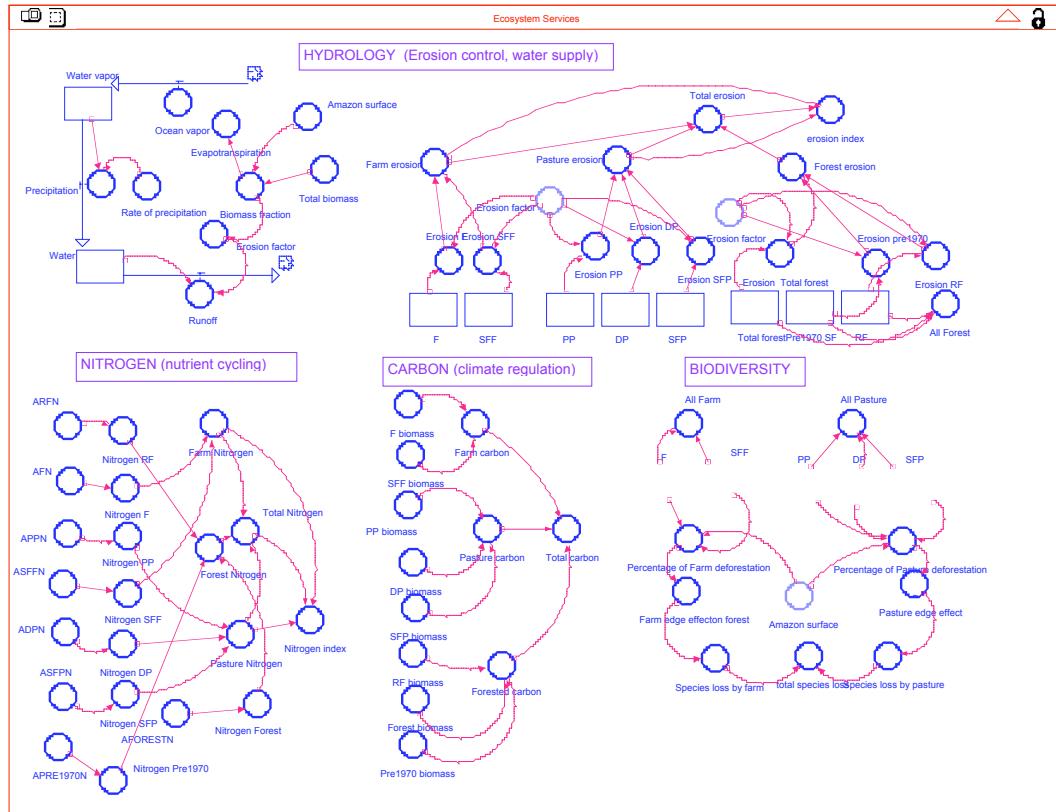

Figure 5. Ecosystem services sector.

In the model the carbon storage capacity of different land-use stocks is determined by their average rates of above-ground biomass as presented by Fearnside (1992a), Fearnside and Guimaraes (1996) and Olson et al. (1983). The product of biomass, average carbon content, and square kilometers was calculated for each category. This result yielded carbon amounts in each land use stock. Total values of carbon were calculated by adding up the amount of carbon in all categories.

Table 1. Average ecological values and associated land use categories.

Land Use Stock	Average above ground biomass (MT/ ha)	Average carbon content of biomass (MT/ ha)	Average nitrogen in top 25cm of soil (MT/ ha)	Average soil loss – erosion (MT/ ha)
Forest	272 ^a	122.00	7.0 ^g	116 ^h
Pasture	10 ^b	4.50	4.5 ^g	580 ⁱ
Degraded Pasture	3 ^c	1.35	4.0 ^g	812 ⁱ
Secondary Forest from Pasture	17 ^d	7.65	6.0 ^g	348 ⁱ
Farm	1 ^e	0.45	3.5 ^g	464 ⁱ
Secondary Forest from Farm	29 ^f	13.05	6.0 ^g	290 ⁱ

^aFrom Fearnside (1992).

^bFrom Olson et al. (1983).

^{c, e, f}From Fearnside and Guimaraes (1996).

^dFrom Uhl et al (1988).

^gEstimated by the authors based on Brown and Lugo (1990).

^hFrom Salati and Vose (1984).

ⁱEstimated by the authors based on by Salati and Vose (1984) and Lavelle (1987).

3.3.2. Erosion Control

Hydrology and biomass are tightly connected in Brazilian Amazonia. Over 50 percent of precipitation in the region is due to water recycling through evapotranspiration (Salati, 1987; Zhang and Henderson-Sellers, 1996). Less biomass means less evapotranspiration and less precipitation. But with regard to the rain that does fall, less interception means that a higher percentage of total water volume falls directly onto the land surface, increasing surface runoff and erosion (Salati and Vose, 1984; Salati, 1987; Lavelle, 1987; Shukla et al., 1990; Fearnside, 1996). The hydrology process over a 100 year simulation is shown graphically in Figure 6.

Average erosion rates in undisturbed forest were measured and reported by Salati and Vose (1984) to be approximately 116 tons km² yr⁻¹. In the model a baseline erosion factor for forest is generated to be consistent with Salati's number by means of

correlation to the biomass fraction, which is explicit in the hydrology submodel. Erosion rates and biomass are inversely related, and studies have found that erosion from the most degraded land is, on average, 7 times higher than erosion from forested land (Lavelle, 1987). Using this spectrum, and making the assumption that degraded pasture would have the highest erosion rate (7 times that of forest), average erosion rates are estimated for each type of land-use stock in the model. The model calculates total erosion figures associated with each type of land use. An erosion index that calculates the rising erosion rates as an index between 0 and 1 feeds back into the land clearing index in the deforestation drivers submodel.

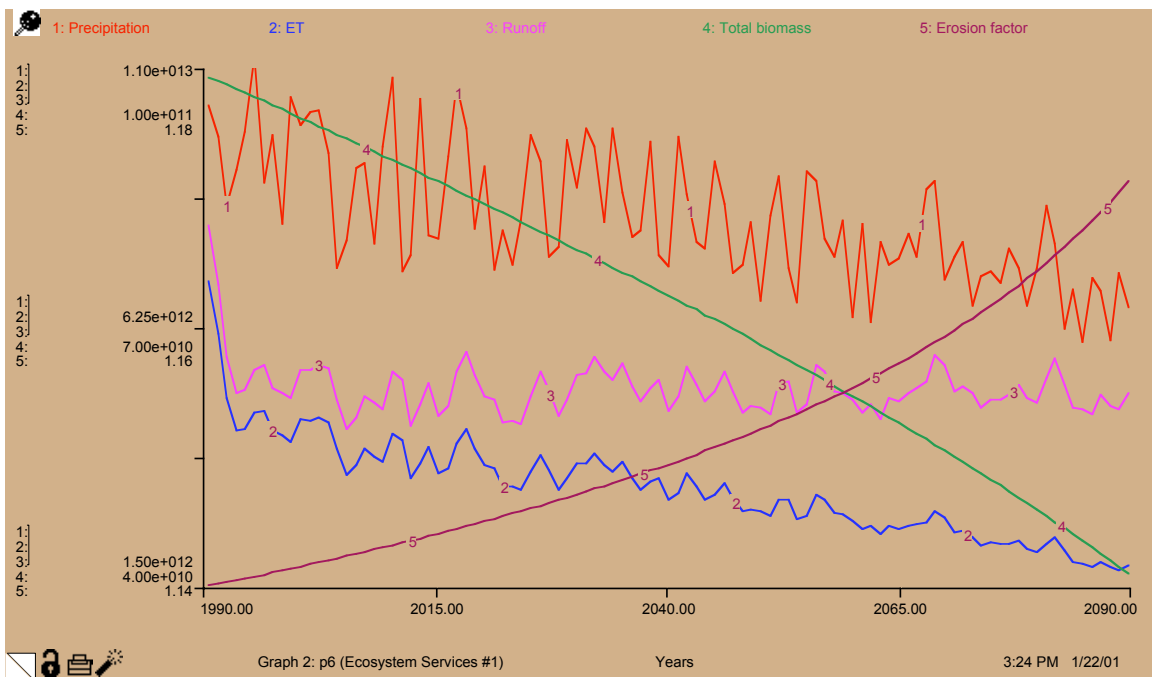

Fig. 6. Hydrology and erosion processes.

3.3.2. Nutrient Cycling

While nutrient levels in Amazonia ecosystems as a whole are high, nutrient cycling is relatively limited. The majority of nutrient stocks are accumulated in the standing biomass rather than in the soil (Salati and Vose, 1984; Lavelle, 1987). Nitrogen and phosphorous are exceptions to this rule and greater amounts are found in the soil, but the cation exchange capacity of soils is severely limited (Lavelle, 1987; Schlesinger, 1991). Clearing the standing biomass of rainforests for pasture and agriculture greatly reduces the nutrient cycling potential of the system (Reiners et al., 1994). Hecht (1983) asserts that with forest conversion to other uses, nutrients held in the biomass are shifted into soil nutrient storage, crops and weeds, or just lost through leaching and erosion. Hence, although a short period of time might follow where soils are actually enhanced by nutrients released in ash from the burning process, these nutrients are quickly leached out of the system (Hecht, 1983; Werner, 1984) due to increased runoff and erosion.

There is limited information available on nutrient amounts that exist above and below ground in the tropical forest (Vitousek, 1984). A review of literature yielded a range of research results and a lack of consensus regarding the below-ground nitrogen storage capacity associated with varying types of land use. The range of research outcomes includes 1) an initial increase in Nitrogen following clearing with a subsequent equilibration, 2) no significant differences before and after forest clearing, and 3) a decrease in soil mineral Nitrogen site after clearing (Eden et al., 1990; Neil et al., 1997; Hughes et al., 1999). Also, there is evidence that post-clearing treatment and land management practices are important factors in the soil chemical properties (Allen, 1985; Eden et al., 1990; Neill et al., 1997). As a general rule, however, after cutting and

burning, soil levels of nitrogen are likely to drop (Ayanaba, 1976) as a result of volatilization (Hecht, 1983).

Brown and Lugo (1990) report decreases in soil Nitrogen pools as a result of forest conversion to pasture and cropland and accumulations of this nutrient as succession takes place. Furthermore, their study shows a pattern of increasing Nitrogen with increasing age of secondary forest and of decreasing Nitrogen with increasing soil depth. It also shows significant lower soil Nitrogen concentration under crops than under forest and pasture sites. This model uses Brown and Lugo's measurements of Nitrogen content values in the top 25 cm of soil as a proxy for nutrients. These Nitrogen values were selected because they account for land use intensity and ecosystem processes (i.e. carbon storage capacity, succession) that are closely aligned with the dynamics depicted in this model. An average Nitrogen content of a mature forest was estimated as 0.7 kg m^{-2} . Storage capacity was also measured for land that had been converted to pasture and farmland, as well as for that in succession following use in either category, and is listed in Table 1. Nitrogen values were multiplied by area to determine a total nutrient value for each land use stock.

3.3.4. Species diversity

Tropical forests cover only six percent of the earth's surface, but are home to over half of all species on the planet (Wilson, 1991). Brazilian Amazonia represents the largest contiguous area of tropical forest that is left on the planet, but this area is quickly diminishing due to deforestation and land cover change. Land transformation is the primary driver of biodiversity loss (Vitousek et.al., 1997), and occurs in Amazonia primarily as a result of farm and ranch activity. Although the overall clearing patterns for

pasture are many times larger than agricultural clearing activity, the clearing pattern for agriculture is more fragmented and contributes to severe edge effects which extend the area affected by agricultural clearing significantly (Laurance et.al., 1998a, 1998b). The edge effect can double the amount of area impacted by agricultural clearing, which has important implications for species loss (Tilman et. al., 1994, Lugo, 1998).

In the model, species loss occurs as a result of changes in land cover (a proxy for changing habitat). Ranching and farming practices generate different types of clearing patterns and edge effects. The relationship between percentage of deforested land and related affected area by edge effect is graphed for both farm and pasture (Laurance et. al., 1998b). Next, proportion P of species loss because of habitat destruction is defined as equation 1 (Tilman et. al., 1994), where D is total area affected (deforested plus edge effect), and z is a constant.

$$P = 1 - (1-D)^z$$

(1)

This equation was calibrated to mimic extinction of species in tropical forests as predicted by Lovejoy (1980), Erlich and Erlich (1981), and as cited by Lugo (1988). These authors estimated that species present in Latin America vary between 300,000 and 1 million. Their conservative projection of 50 percent deforestation corresponded to a 33 percent loss of species.

4. Ecosystem valuation submodel

This submodel associates the loss in ecosystem services related to conversion of forest to farm and pasture with a monetary reference value per hectare. “Farm value”

incorporates active farmland (F) and secondary forest from farm (SFF). “Pasture value” includes productive pasture (PP), degraded pasture (DP) and secondary forest from pasture (SFP).

The original monetary value of ecosystem services used as reference for tropical forest are taken from a 1997 publication, “The value of the world’s ecosystem services and natural capital.” (Costanza et al.). These values are shown below in Table 2. The total per hectare value of these services for tropical areas is reported to be \$1,431 annually. Farm values and pasture values calculated by the model represent the decreased ecosystem service value of land that has been cleared for these productive uses. Values are calculated for four primary services: (1) climate regulation, (2) nutrient cycling, (3) erosion control, and (4) genetic resources.

4.1. Climate regulation

Climate regulation is based on carbon storage capacity. In the valuation of carbon, the average carbon content of biomass in each land category (45 percent of above-ground biomass according to Fearnside and Guimaraes, 1996), was weighted by the average carbon amount in forest and then multiplied by the forest monetary value for that service (\$223 ha⁻¹ yr⁻¹). Calculations were done to obtain total carbon value (Total C value), which is an annual monetary value for the entire Brazilian Amazonia resulting from the aggregated area of farm (Farm carbon value), pasture (Pasture carbon value) and forest (Forest carbon value). A unit value for each land category was also calculated (unit Farm C, and unit Pasture C). This value corresponds to an annual flow of service per hectare of

land use, and is useful in comparing with the Costanza's reference value for climate regulation.

4.2. Nutrient cycling

Nutrient cycling is based on the amount of Nitrogen present in soil nutrient pools. These values were explained in detail in the ecosystem services section of this paper. The amount of Nitrogen present in primary forest samples was associated to the value for nutrient cycling ($\$922 \text{ ha}^{-1} \text{ yr}^{-1}$) given by Costanza et al. (1997). The same process used to derive carbon values was used to calculate total and unit values for nitrogen present in different land use stocks.

4.3. Erosion control

The value for erosion control decreases as the amount of erosion in the ecosystem services submodel increases. The initial value for erosion control in primary forest was calculated by Costanza et al. at $\$245 \text{ ha}^{-1} \text{ yr}^{-1}$. The erosion control values are weighted by the proportion of land that is incorporated in aggregated farm and aggregated pasture land use types.

4.4. Genetic resources

The ecosystem service value of genetic resources that is used in this model incorporates only the pharmaceutical value associated with species diversity (Costanza et al., 1997). Depreciation of this value in the model occurs as the overall number of

species fall due to deforestation and increased edge effects. The original forest value for genetic resources is \$41 ha⁻¹ yr⁻¹.

5. Results and Discussion

Results of a 100-year simulation run of the model show that forest area declines to about 44 percent of original forest area with pasture and abandoned pasture becoming the dominant land cover. The value of the four ecosystem services represented in this model declines for converted forest, from \$1431 per hectare per year to \$657 and \$781 per hectare per year for agriculture and pasture, respectively. Table 2 summarizes the findings, which are considered in more detail in the sections below.

Table 2. Value of ecosystem services

<i>Ecosystem Services</i>	<i>Forest Reference^a</i>	<i>Farm</i>	<i>Pasture</i>	<i>Total Amazon</i>
	<i>(\$ ha/yr)</i>			<i>\$/yr 1E6</i>
Climate Regulation	223.00	7.00	11.00	33,972.00
Erosion Control	245.00	66.00	61.00	50,849.00
Nutrient Cycling	922.00	556.00	677.00	303,397.00
Genetic Resources	41.00	29.00	32.00	14,048.00
TOTAL	1,431.00	658.00	781.00	402,266.00

^aFrom Costanza et al. 1997

5.1. Land use

In a 100 year modeling scenario, the Brazilian Amazonia forest area declines by 56 percent, and the total area ever deforested reaches 66 percent. This number fluctuates due to random parameters within the model, but consistently produces results within an acceptable range around this value. As is shown in Table 3 below, the majority of cleared land is either under use as productive pasture or is secondary forest derived from

pasture. Taken together, these two categories account for 86 percent of deforested land. Total pasture area, including the above two categories just noted and degraded pasture, account for 90 percent of land cleared. This is equivalent to 2,373,714 km². These results are consistent with results found in Fearnside (1996).

Table 3. Total deforestation by land use category.

<i>Land Use Stock</i>	<i>Total Area (km²)</i>	<i>% of Total Deforested Land</i>
Farm	132,176	5
Secondary Forest from Farm	53,196	2
Productive Pasture	1,215,147	46
Degraded Pasture	113,428	4
Secondary Forest from Pasture	1,045,139	40

Farm and secondary forest from farm account for only 7 percent of total deforested land. This result may seem inconsistent with earlier observations that 30 percent of deforestation is at the hands of small farmers. Farmers, however, convert a large majority of their holdings into pasture as household structure, economic incentives and soil fertility change. This land becomes considered as pasture in future transitions in the model.

While we realize that there are tradeoffs and limitations to using static transition percentages to model dynamic land use patterns, we agree with Fearnside that such an approach is “valuable as a first approximation” to dealing with the issue (ibid.). We were also inclined to pursue this option due to a lack of data with which to calibrate or track land use transitions using a more dynamic approach.

Land transitions and final amounts of land accumulating in different land use types are important for all of the changes in ecosystem services and corresponding decreases in monetary value. Results for each service are discussed in turn. Graphs of each service are located in Appendix B.

5.2. Carbon sequestration/climate regulation

Fifty-six percent deforestation of Amazonia over a 100 year model simulation resulted in a 42 percent decrease in carbon storage capacity. The discrepancy between deforestation and carbon storage projections is due to high level of secondary regrowth that occurs. This mitigates the loss in carbon storage capacity that would otherwise occur.

The value of climate regulation (related here as carbon storage capacity) per hectare decreases significantly between forested and deforested land. Values for carbon storage and climate regulation also differ between farm and pasture areas. Compared to the forest reference value of \$223 per hectare, the value of climate regulation services for agricultural area in Amazonia falls to just \$7, and the value of pasture falls to \$11. The reason for the decline is the extreme loss of biomass associated with each land use type in the model. The average storage capacities were averaged between all farm-related land use stocks and all pasture-related land use stocks to derive these numbers. Farm area loses more carbon storage value per hectare than pasture due to the quicker transition periods that exist between use and fallow. Quick succession and higher land use intensity result in biomass levels that are lower over time.

The low average value given by Fearnside for biomass on agricultural land is the primary reason for the difference between farm and pasture. Given that leaf area indices

for agricultural areas can be quite high, it is possible that this number is too low and loss of carbon storage value is overestimated.

5.3. Erosion/erosion control

The sediment load associated with deforested conditions is 1 billion tons/year. Without deforestation, this load is 572 million tons per year. This represents an erosion rate that is 2.4 times higher under the deforestation simulation than they would be the case without deforestation. The reference value for erosion control that we used was \$245 per hectare. The corresponding values for farm and pasture land were \$66 and \$61 respectively. Pasture lost more value relative to farm primarily due to some of the model assumptions, including higher rates of erosion for degraded pasture than any other land use stock.

5.4. Nitrogen/nutrient cycling

Nitrogen storage capacity decreased in the model by 16 percent for the region as a whole during the 100-year simulation. The reference value for nutrient cycling services in tropical forests was quite high, \$922 per hectare. Land used primarily as farm provided \$556 dollars of nutrient cycling services, a 40 percent reduction over the reference case. Pasture value was 27 percent lower than the reference forest value or \$677 per hectare. The different values calculated for pasture and farm again appear to be accounted for by differences in vegetation regrowth patterns between the two land use types. Farm areas are subject to greater nutrient leaching levels than are productive or secondary pasture due to the higher intensity of land use on farm property.

We see two limitations to our approach to modeling and valuing nutrient cycling services. First, the use of nitrogen storage capacity as a proxy for nutrient cycling is a great simplification of the nutrient cycling processes that occur in the Amazon. Second, the use of average numbers for nitrogen stocks in the land use categories creates limitation on the degree of feedback and dynamic behavior that can be reflected in the model.

5.5. Species diversity/genetic resources

Species loss in the Brazilian Amazonia grew to 51 percent over the 100 year simulation period, up from 34 percent in the initial scenario in the 1990 baseline year. This majority of species loss in the model was attributed to deforestation from pasture. This is not because—hectare per hectare—land converted to pasture is more damaging to species than land converted for farming. On the contrary, research indicates that the edged effects and intensity of land use associated with farming creates more threats to species diversity than large scale ranching. In an aggregated model such as this, however, the overwhelming scale of deforestation related to pasture use means that more species loss will be attributed to this type of land use than to farming.

The reference value for genetic resources is \$41 per hectare (Costanza et al., 1997). On a hectare by hectare basis, farmland lost more of its genetic resource service value than ranch land. The model showed that the annual service value of genetic resources on farm land fell to \$29 ha⁻¹ yr⁻¹, while that of pasture fell to \$32 ha⁻¹ yr⁻¹. The reference value for genetic resources only refers to the market value for pharmaceuticals. Species diversity, however, has been shown by many ecologists to play a larger role in

ecosystem stability (Holling, 1996, Peterson, 1998). For this reason, we believe that the value of genetic resources undervalues the total contribution of species diversity to ecosystem services.

5.6. Comparison of market and ecosystem service values

Addition of the adjusted values for climate regulation, nutrient cycling, erosion control and species diversity numbers reveal that the overall per hectare value of ecosystem services declines by 45 percent for ranching, and by 54 percent for farming over the period of simulation. The difference between the two rates of depreciation stems mainly from the high monetary reference value ascribed to nutrient cycling as a service, and the fact that agricultural practices tend to cause greater disruption of this cycle.

Investigating the extent to which different land use practices and patterns of land cover change degrade the monetary value of ecosystem services is a helpful process in its own right. The altered value of ecosystem services becomes even more of a discussion point, however, when it is compared to the annual revenue streams that flow from the land use practices that replace forest and cause the depreciation in their service value.

In recent years, initial efforts have been made to calculate the revenue generated by ranching and agricultural practices in the Brazilian Amazonia. A series of studies designed by Christopher Uhl and research partners were conducted to document the average annual income per hectare that widespread ranching and farming techniques generate (Mattos and Uhl, 1994, Toniolo and Uhl, 1995, Almeida and Uhl, 1995). Their research documents gross annual returns, profits, investment costs and other calculations that pertain to the prevailing extensive models of both ranching and agriculture. For

purposes of this analysis, we have chosen to present the annual value of ecosystem services alongside the gross annual returns to ranching and farming presented by Almeida and Uhl (1995).

For prevailing models of extensive ranching, gross returns are calculated to be \$31 ha yr⁻¹. For prevailing models of agricultural production (extensive and shifting), returns are calculated at \$90 ha yr⁻¹. When gross returns from ranching and farming are compared to the annual value of ecosystem services, the disparity is striking: A gross annual return to ranching of \$31 per hectare compares to an ecosystem service value of \$781 per hectare. Similarly, a gross annual return to agriculture of \$90 per hectare compares to an ecosystem service value of \$658 per hectare. Even with the significant monetary losses in the value of ecosystem services over the forest reference value of \$1431, the annual value of services from land used for ranching is 25 times the amount of revenue generated from a hectare of land used for ranching. The value of ecosystem services provided by land used for farming is 7 times greater than the revenue farmers can generate from their activities. If land was kept entirely out of production and remained as undisturbed forest, the differential between the annual service value of the ecosystem and the annual revenue from ranch and farm activities would be 48 and 16, respectively.

It is quite possible that the depreciation in ecosystem services values generated by the model is too conservative. The assumption is that the value of ecosystem services decreases in a linear fashion. In biological systems, however, there is a point where the degree of degradation compromises the system's stability and its overall resilience

(Holling, 1996, Peterson and Holling, 1998). In such cases, the services (and thus the corresponding monetary value of the service) may be irretrievably lost (Barbier 1994).

There are obvious practical problems associated with comparing the annual monetary flows of ranching and farming activities with the inferred value of ecosystem services. Such comparisons are irrelevant to individuals engaged in ranching and farming because ecosystem services are public goods (Lawn 2001) and, as such, carry no “real” monetary value that individuals could benefit from. While there is a private monetary return to individuals who engage in ranching and farming practices, the existence of a pristine forest provides services that benefit society as a whole. The current non-market—and hence non-priced—nature of ecosystem services is an impediment to creating a system of incentives that would lead land holders in Brazilian Amazonia to see a loss in the value of ecosystem services as significant opportunity cost. Under the conditions simulated in this model, the opportunity costs associated with converting forest into ranching and farming uses would be \$650 and \$773 per hectare per year, respectively.

6. Conclusion: toward a rationale for explicit valuation of ecosystem services

The model described in this paper provides a rough approximation of the loss of ecosystem services that is attributable to deforestation, if current patterns and processes of land use—and the economic incentives that drive them—continue unabated.

Land usage in the Brazilian Amazonia is currently influenced by an array of private preferences and public mandates. On one side, individual ranchers and farmers work to ensure their well-being by using their land in ways that generate the highest

returns. At the same time, the public needs a healthy ecosystem to regulate regional and global climate patterns, and provide other fundamental services that ensure well-being. As we have demonstrated with this model, the private preferences of individuals are not always compatible with public needs (Norgaard, 1989).

The monetary approach to ecosystem valuation provides one means of overcoming the incompatibility of public and private preferences. When the forests that provide vital services are valued by private markets in monetary terms, individuals receive signals that indicate the importance of resource conservation. What a monetary valuation of ecosystem services cannot convey, however, is a sense of the intrinsic or inherent value of an intact ecosystem that exists regardless of human benefit.

This model has been a first attempt to dynamically describe and display the processes that degrade ecosystem services over time. In the future, more work must be done to provide alternative scenarios that can demonstrate ways in which development of Amazonia can be sustaining for both the people who live in Amazonia and people from other parts of the world who depends on the services provided by this ecosystem. Assessment of the value of ecosystem services is crucial in bringing awareness and understanding to the benefits they provide, and to the absolute need of taking such values into account in decision-making processes.

Acknowledgments:

We are grateful to both Robert Costanza and Alexy Voinov for assistance in developing this model. In addition, we thank our classmates in the Modeling Ecological and Ecosystems course at the University of Maryland for the insightful discussions and

suggestions. Particularly, we thank Stephen Smith for comments to the manuscript and modeling approach. While we benefited greatly from the assistance of our professors and peers, we take full responsibility for any limitations and assumptions in the model.

Appendix A

A.1. Deforestation Drivers Sector

$ag_households(t) = ag_households(t - dt) + (farms_per_year) * dt$

INIT $ag_households = 1445142$

INFLOWS:

$farms_per_year = new_ag_households$

$Population(t) = Population(t - dt) + (Pop_growth - outmigration_and_death) * dt$

INIT $Population = 9337153$

INFLOWS:

$Pop_growth = ((Population * .02) + migrants) * (1 - Population / 3e7)$

OUTFLOWS:

$outmigration_and_death = .005 * Population$

$ranches(t) = ranches(t - dt) + (ranches_per_yr) * dt$

INIT $ranches = 156399$

INFLOWS:

$ranches_per_yr = new_ranches$

$ag_population = .45 * Population$

$ag_pop_change = ag_population - DELAY(ag_population, 1)$

$Amplitude = 25$

$Base_year = 20$

$Economic_growth_rate = 2$

$Economic_trends = DELAY((Econ_Long_term_trend + Econ_periodicity + Econ_random), 0.5)$

$Econ_Long_term_trend = 25 + ((TIME - 1990) * Economic_growth_rate)$

$Econ_periodicity = (SINWAVE(Amplitude, Period))$

$Econ_random = RANDOM(-15, 15)$

$Econ_trend_index = (Economic_trends / Base_year) / 100$

$land_spec_index = (Econ_trend_index) + Infrastructure$

$migrants = ag_pop_change * migration_rate$

$migration_rate = (land_spec_index * Non_Amazon_Land_Dist) * (new_ranches * .05)$

$new_ag_households = (ag_pop_change + migrants) / 5$

$new_ranches = land_spec_index * property_investors$

$Non_Amazon_Land_Dist = 0.05$

$Period = 10$

$property_investors = (2 * ranches / Biomass_fraction) * 100$

$Growth_Data = GRAPH(time)$

(1984, 2.00), (1985, 1.90), (1986, 2.00), (1987, 2.00), (1988, 1.90), (1989, 1.80), (1990, -4.00), (1991, 1.00), (1992, -1.00), (1993, 5.00), (1994, 5.80), (1995, 4.30), (1996, 2.90), (1997, 3.50), (1998, 0.2)

$Infrastructure = GRAPH(time)$

(1990, 0.01), (1998, 0.09), (2007, 0.075), (2015, 0.1), (2023, 0.11), (2032, 0.11), (2040, 0.12), (2048, 0.205), (2057, 0.225), (2065, 0.24), (2073, 0.265), (2082, 0.28), (2090, 0.3)

A.2. Ecosystem Services

$$\text{Water}(t) = \text{Water}(t - dt) + (\text{Precipitation} - \text{Runoff} - \text{ET}) * dt$$

$$\text{INIT Water} = 1.2 * 12.7e12$$

INFLOWS:

$$\text{Precipitation} = \text{Rate_of_precipitation} * \text{Water_vapor}$$

OUTFLOWS:

$$\text{Runoff} = 0.8 * \text{Water} * \text{Erosion_factor}$$

$$\text{ET} = \text{Water} * \text{Evapotranspiration}$$

$$\text{Water_vapor}(t) = \text{Water_vapor}(t - dt) + (\text{Ocean_vapor} + \text{ET} - \text{Precipitation}) * dt$$

$$\text{INIT Water_vapor} = \text{Ocean_vapor} + \text{ET}$$

INFLOWS:

$$\text{Ocean_vapor} = 5E12$$

$$\text{ET} = \text{Water} * \text{Evapotranspiration}$$

OUTFLOWS:

$$\text{Precipitation} = \text{Rate_of_precipitation} * \text{Water_vapor}$$

$$\text{ADPN} = 400$$

$$\text{AFN} = 350$$

$$\text{AFORESTN} = 700$$

$$\text{All_Farm} = \text{SFF} + \text{F}$$

$$\text{All_Forest} = \text{Pre1970_SF} + \text{RF} + \text{Total_forest}$$

$$\text{All_Pasture} = \text{DP} + \text{PP} + \text{SFP}$$

$$\text{Amazon_surface} = 4E6$$

$$\text{APPN} = 450$$

$$\text{APRE1970N} = 700$$

$$\text{ARFN} = 0.7e3$$

$$\text{ASFFN} = 600$$

$$\text{ASFPN} = 600$$

$$\text{Average_RF_biomass_2} = 148E2$$

$$\text{Biomass_fraction} = \text{Total_biomass} / \text{Amazon_surface}$$

$$\text{Carbon_index} = ((\text{Total_carbon} - \text{Farm_carbon} - \text{Pasture_carbon}) / \text{Total_carbon})$$

$$\text{Erosion_DP} = 7 * (\text{Erosion_factor} * \text{DP}) * 100$$

$$\text{Erosion_F} = 4 * (\text{Erosion_factor} * \text{F}) * 100$$

$$\text{Erosion_factor} = (1 / (\text{Biomass_fraction} - 2500)^{0.2} + 1)$$

$$\text{erosion_index} = 1 - ((\text{Total_erosion} - \text{Farm_erosion} - \text{Pasture_erosion}) / \text{Total_erosion})$$

$$\text{Erosion_PP} = 5 * (\text{Erosion_factor} * \text{PP}) * 100$$

$$\text{Erosion_pre1970} = (\text{Erosion_factor} * \text{Pre1970_SF}) * 100$$

$$\text{Erosion_RF} = (\text{Erosion_factor} * \text{RF}) * 100$$

$$\text{Erosion_SFF} = 3 * (\text{Erosion_factor} * \text{SFF}) * 100$$

$$\text{Erosion_SFP} = 2.5 * (\text{Erosion_factor} * \text{SFP}) * 100$$

$$\text{Erosion_Total_forest} = (\text{Erosion_factor} * \text{Total_forest}) * 100$$

$$\text{Evapotranspiration} = \text{Biomass_fraction} / (\text{Biomass_fraction} + 28369)$$

$$\text{Farm_carbon} = (\text{F_biomass} + \text{SFF_biomass}) * 0.45$$

$$\text{Farm_erosion} = \text{Erosion_F} + \text{Erosion_SFF}$$

$$\text{Farm_Nitrogen} = \text{Nitrogen_F} + \text{Nitrogen_SFF}$$

$$\text{Forested_carbon} = (\text{Forest_biomass} + \text{Pre1970_biomass} + \text{RF_biomass}) * 0.45$$

$$\text{Forest_erosion} = (\text{Erosion_pre1970} + \text{Erosion_RF} + \text{Erosion_Total_forest})$$

$$\text{Forest_Nitrogen} = \text{Nitrogen_RF} + \text{Nitrogen_Forest} + \text{Nitrogen_Pre1970}$$

$$\text{Nitrogen_DP} = \text{DP} * \text{ADPN}$$

Nitrogen_F = F*AFN
 Nitrogen_Forest = Total_forest*AFORESTN
 Nitrogen_index = ((Total_Nitrogen-Pasture_Nitrogen-Farm_Nitrogen)/Total_Nitrogen)
 Nitrogen_PP = PP*APPN
 Nitrogen_Pre1970 = Pre1970_SF*APRE1970N
 Nitrogen_RF = RF*ARFN
 Nitrogen_SFF = SFF*ASFFN
 Nitrogen_SFP = ASFPN*SFP
 Pasture_carbon = (DP_biomass+PP_biomass+SFP_biomass)*0.45
 Pasture_erosion = (Erosion_DP+Erosion_PP+Erosion_SFP)
 Pasture_Nitrogen = Nitrogen_DP+Nitrogen_PP+Nitrogen_SFP
 Percentage_of_Farm_deforestation = (F+SFF)/Amazon_surface
 Percentage_of_Pasture_deforestation = (DP+PP+SFP)/Amazon_surface
 Rate_of_precipitation = RANDOM(0.5,0.9)
 Species_loss_by_farm = 1-(1-Farm_edge_effecton_forest)^1.5
 Species_loss_by_pasture = 1-(1-Pasture_edge_effect)^1.5
 Total_carbon = Farm_carbon+Forested_carbon+Pasture_carbon
 Total_erosion = Farm_erosion+Forest_erosion+Pasture_erosion
 Total_Nitrogen = Farm_Nitrogen+Forest_Nitrogen+Pasture_Nitrogen
 total_species_loss = Species_loss_by_farm+Species_loss_by_pasture
 Farm_edge_effecton_forest = GRAPH(Percentage_of_Farm_deforestation)
 (0.00, 0.165), (0.111, 0.27), (0.222, 0.32), (0.333, 0.36), (0.444, 0.365), (0.556, 0.365), (0.667, 0.36),
 (0.778, 0.345), (0.889, 0.305), (1.00, 0.17)
 Pasture_edge_effect = GRAPH(Percentage_of_Pasture_deforestation)
 (0.00, 0.025), (0.1, 0.075), (0.2, 0.11), (0.3, 0.14), (0.4, 0.16), (0.5, 0.16), (0.6, 0.15), (0.7, 0.13), (0.8,
 0.08), (0.9, 0.04)

A.3. Ecosystem Valuation

Average_Farm_Erosion = Farm_erosion/All_Farm
 Average_Pasture_Erosion = Pasture_erosion/All_Pasture
 Farm_C_value = All_Farm*Unit_Farm_C
 Farm_E_value = All_Farm*Unit_Farm_E
 Farm_N_Value = (Unit_Farm_N*All_Farm)
 Farm_S_value = All_Farm*Unit_Farm_S
 Forest_C_value = All_Forest*Unit_Forest_C
 Forest_E_value = All_Forest*Forest_Value
 Forest_N_value = All_Forest*Unit_Forest_N
 Forest_S_value = All_Forest*Unit_Forest_S
 Forest_Value = 245
 Pasture_C_value = All_Pasture*Unit_Pasture_C
 Pasture_E_value = All_Pasture*Unit_Pasture_E
 Pasture_N_value = All_Pasture*Unit_Pasture_N
 Pasture_S_value = All_Pasture*Unit_Pasture_S
 Total_Amazon_Value = (Total_C_value+Total_N_Value+Total_E_value+Total_S_Value)
 Total_C_value = (Farm_C_value+Forest_C_value+Pasture_C_value)*1e2/1e6
 Total_E_value = (Farm_E_value+Forest_E_value+Pasture_E_value)*1e2/1e6
 Total_N_Value = (Farm_N_Value+Pasture_N_value+Forest_N_value)*1e2/1e6
 Total_S_Value = (Pasture_S_value+Farm_S_value+Forest_S_value)*1e2/1e6
 Total_Unit_Farm = Unit_Farm_C+Unit_Farm_N+Unit_Farm_S+Unit_Farm_E
 Total_Unit_Pasture = Unit_Pasture_C+Unit_Pasture_E+Unit_Pasture_N+Unit_Pasture_S
 Unit_Avg_Value_S = (Farm_S_value/All_Farm+Pasture_S_value/All_Pasture)/2
 Unit_DP_Carbon = ADPB*223/(AFORESTB)
 Unit_DP_Nitrogen = ADPN*922/AFORESTN
 Unit_Farm_C = ((F_biomass+SFF_biomass)/All_Farm)*223/(AFORESTB)
 Unit_Farm_E = (Forest_Value*116)/Average_Farm_Erosion

$Unit_Farm_N = (Nitrogen_F + Nitrogen_SFF) / All_Farm * 922 / AFORESTN$
 $Unit_Farm_S = (41 - (Species_loss_by_farm * 41))$
 $Unit_Forest_C = (Forest_biomass + Pre1970_biomass + RF_biomass) / All_Forest * 223 / (AFORESTB)$
 $Unit_Forest_N = (Nitrogen_Forest + Nitrogen_Pre1970 + Nitrogen_RF) / All_Forest * 922 / AFORESTN$
 $Unit_Forest_S = 41$
 $Unit_F_Carbon = AFB * 223 / (AFORESTB)$
 $Unit_F_Nitrogen = AFN * 922 / AFORESTN$
 $Unit_Pasture_C = ((DP_biomass + PP_biomass + SFP_biomass) / All_Pasture) * 223 / (AFORESTB)$
 $Unit_Pasture_E = Forest_Value * 116 / Average_Pasture_Erosion$
 $Unit_Pasture_N = (Nitrogen_DP + Nitrogen_PP + Nitrogen_SFP) / All_Pasture * 922 / AFORESTN$
 $Unit_Pasture_S = (41 - (Species_loss_by_pasture * 41))$
 $Unit_PP_Carbon = APPB * 223 / (AFORESTB)$
 $Unit_PP_Nitrogen = APPN * 922 / AFORESTN$
 $Unit_SFF_Carbon = ASFFB * 223 / (AFORESTB)$
 $Unit_SFF_Nitrogen = ASFFN * 922 / AFORESTN$
 $Unit_SFP_Carbon = ASFPB * 223 / (AFORESTB)$
 $Unit_SFP_Nitrogen = ASFPN * 922 / AFORESTN$
 $Unit_Value_S_loss = (Unit_Pasture_S + Unit_Farm_S)$

A.4. Land use/cover sector

$DP(t) = DP(t - dt) + (Conversion_of_PP_to_DP - Conversion_of_DP_to_SFP - Conversion_of_DP_to_PP) * dt$

INIT DP = 8E3

INFLOWS:

Conversion_of_PP_to_DP = PP * Rate_of_PP_to_DP

OUTFLOWS:

Conversion_of_DP_to_SFP = DP * Rate_of_DP_to_SFP

Conversion_of_DP_to_PP = DP * Rate_of_DP_to_PP

$F(t) = F(t - dt) + (Conversion_of_RF_to_F + Conversion_from_SFP_ \& _SFF +$

$Conversion_of_deforested_land_to_Farming - Conversion_of_F_to_PP - Conversion_of_F_to_SFF) * dt$

INIT F = 22E3

INFLOWS:

Conversion_of_RF_to_F = RF * Rate_of_RF_to_F

Conversion_from_SFP_&_SFF = Conversion_of_SFP_to_F + Conversion_of_SFF_to_F

Conversion_of_deforested_land_to_Farming = Rate_of_deforested_land_to_F * New_deforested_land

OUTFLOWS:

Conversion_of_F_to_PP = F * Rate_of_F_to_PP

Conversion_of_F_to_SFF = F * Rate_of_F_to_SFF

$PP(t) = PP(t - dt) + (Conversion_from_F_DP_SFP_SFF + Conversion_of_RF_to_PP +$

$Conversion_of_deforested_land_to_PP - Conversion_of_PP_to_DP - Conversion_of_PP_to_SFP) * dt$

INIT PP = 184E3

INFLOWS:

Conversion_from_F_DP_SFP_SFF =

Conversion_of_F_to_PP + Conversion_of_SFF_to_PP + Conversion_of_SFP_to_PP + Conversion_of_DP_to_PP

Conversion_of_RF_to_PP = RF * Rate_of_RF_to_PP

Conversion_of_deforested_land_to_PP = Rate_of_deforested_land_to_PP * New_deforested_land

OUTFLOWS:

Conversion_of_PP_to_DP = PP * Rate_of_PP_to_DP

$Conversion_of_PP_to_SFP = PP * Rate_of_PP_to_SFP$
 $Pre1970_SF(t) = Pre1970_SF(t - dt)$
 $INIT\ Pre1970_SF = 71e3$

$RF(t) = RF(t - dt) + (RF_conversion - Conversion_of_RF_to_F - Conversion_of_RF_to_PP) * dt$

INIT RF = 0

INFLOWS:

$RF_conversion = Conversion_of_SFF_to_RF + Conversion_of_SFP_to_RF$

OUTFLOWS:

$Conversion_of_RF_to_F = RF * Rate_of_RF_to_F$

$Conversion_of_RF_to_PP = RF * Rate_of_RF_to_PP$

$SFF(t) = SFF(t - dt) + (Conversion_of_F_to_SFF - Conversion_of_SFF_to_F - Conversion_of_SFF_to_PP - Conversion_of_SFF_to_RF) * dt$

INIT SFF = 8E3

INFLOWS:

$Conversion_of_F_to_SFF = F * Rate_of_F_to_SFF$

OUTFLOWS:

$Conversion_of_SFF_to_F = SFF * Rate_of_SFF_to_F$

$Conversion_of_SFF_to_PP = SFF * Rate_of_SFF_to_PP$

$Conversion_of_SFF_to_RF = SFF * Rate_of_SFF_to_RF$

$SFP(t) = SFP(t - dt) + (Conversion_of_DP_to_SFP + Conversion_of_PP_to_SFP1 -$

$Conversion_of_SFP_to_PP - Conversion_of_SFP_to_RF - Conversion_of_SFP_to_F) * dt$

INIT SFP = 115E3

INFLOWS:

$Conversion_of_DP_to_SFP = DP * Rate_of_DP_to_SFP$

$Conversion_of_PP_to_SFP1 = Conversion_of_PP_to_SFP$

OUTFLOWS:

$Conversion_of_SFP_to_PP = SFP * Rate_of_SFP_to_PP$

$Conversion_of_SFP_to_RF = SFP * Rate_of_SFP_to_RF$

$Conversion_of_SFP_to_F = SFP * Rate_of_SFP_to_F$

$Rate_of_forest_to_deforested = New_deforested_land$

OUTFLOW FROM: Total_forest(Not in a sector)

INFLOW TO: Deforested_SV(Not in a sector)

ADPB = 3.4E2

AFB = 1E2

AFORESTB = 272

APPB = 10E2

APRE1970B = 148E2

ARFB = 148E2

ASFFB = 29E2

ASFPB = 17e2

DP_biomass = DP * ADPB

established_ag_clearing =

$((ag_households/12) * (yearly_avg_clear_ag)) + ((ag_households/12) * (clearing_rate_index))$

$established_pasture_clearing = ((ranches/5) * (yearly_avg_clear_ranch)) + ((ranches/5) * (clearing_rate_index))$

Forest_biomass = Total_forest * AFORESTB

F_biomass = AFB * F

$new_ag_clearing = ((new_ag_households * 3E-3) + established_ag_clearing)$

$$\text{New_deforested_land} = (\text{new_ag_clearing} + \text{new_pasture_clearing})$$

$$\text{new_pasture_clearing} = \text{DELAY}(((\text{new_ranches} * 50E-2) + \text{established_pasture_clearing}), 0.5)$$

$$\text{Percent_of_Amazon_Def_Land} = \text{Total_deforested_land} / \text{Original_Forest}$$

$$\text{PP_biomass} = \text{PP} * \text{APPB}$$

$$\text{Pre1970_biomass} = \text{Pre1970_SF} * \text{APRE1970B}$$

$$\text{Proportion_of_DP} = \text{DP} / \text{Total_deforested_land}$$

$$\text{Proportion_of_F} = \text{F} / \text{Total_deforested_land}$$

$$\text{Proportion_of_PP} = \text{PP} / \text{Total_deforested_land}$$

$$\text{Proportion_of_pre1970_SF} = \text{Pre1970_SF} / \text{Total_deforested_land}$$

$$\text{Proportion_of_RF} = \text{RF} / \text{Total_deforested_land}$$

$$\text{Proportion_of_SFF} = \text{SFF} / \text{Total_deforested_land}$$

$$\text{Proportion_of_SFP} = \text{SFP} / \text{Total_deforested_land}$$

$$\text{Rate_of_deforested_land_to_F} = \text{new_ag_clearing} / \text{New_deforested_land}$$

$$\text{Rate_of_deforested_land_to_PP} = \text{new_pasture_clearing} / \text{New_deforested_land}$$

$$\text{Rate_of_DP_to_PP} = 0.007$$

$$\text{Rate_of_DP_to_SFP} = 0.067$$

$$\text{Rate_of_F_to_PP} = 0.468$$

$$\text{Rate_of_F_to_SFF} = 0.082$$

$$\text{Rate_of_PP_to_DP} = 0.008$$

$$\text{Rate_of_PP_to_SFP} = 0.143$$

$$\text{Rate_of_RF_to_F} = 0.347$$

$$\text{Rate_of_RF_to_PP} = 0.653$$

$$\text{Rate_of_SFF_to_F} = 0.065$$

$$\text{Rate_of_SFF_to_PP} = 0.128$$

$$\text{Rate_of_SFF_to_RF} = 0.000000001$$

$$\text{Rate_of_SFP_to_F} = 0.061$$

$$\text{Rate_of_SFP_to_PP} = 0.101$$

$$\text{Rate_of_SFP_to_RF} = 0.0000001$$

$$\text{RF_biomass} = \text{RF} * \text{ARFB}$$

$$\text{SFF_biomass} = \text{SFF} * \text{ASFFB}$$

$$\text{SFP_biomass} = \text{SFP} * \text{ASFPB}$$

$$\text{soil_fertility} = \text{RANDOM}(1, 1)$$

$$\text{Total_biomass} = \text{Forest_biomass} + \text{Total_deforested_area_biomass}$$

$$\text{Total_deforested_area_biomass} =$$

$$\text{RF_biomass} + \text{F_biomass} + \text{PP_biomass} + \text{SFF_biomass} + \text{DP_biomass} + \text{SFP_biomass} + \text{Pre1970_biomass}$$

$$\text{Total_deforested_land} = (\text{DP} + \text{F} + \text{PP} + \text{Pre1970_SF} + \text{RF} + \text{SFF} + \text{SFP})$$

$$\text{yearly_avg_clear_ag} = .3e-2$$

$$\text{yearly_avg_clear_ranch} = 25e-2$$

$$\text{Deforestation_INPE} = \text{GRAPH}(\text{time})$$

(1988, 22530), (1989, 23900), (1990, 13800), (1991, 11200), (1992, 13790), (1993, 14900), (1994, 14900), (1995, 27080), (1996, 20010), (1997, 13230), (1998, 16840)

A.5. Not in a sector

$$\text{Deforested_SV}(t) = \text{Deforested_SV}(t - dt) + (\text{Rate_of_forest_to_deforested}) * dt$$

INIT Deforested_SV = 410e3

INFLOWS:

Rate_of_forest_to_deforested (IN SECTOR: Land use/cover sector)

$$\text{Total_forest}(t) = \text{Total_forest}(t - dt) + (- \text{Rate_of_forest_to_deforested}) * dt$$

INIT Total_forest = 4E6-410e3

OUTFLOWS:

Rate_of_forest_to_deforested (IN SECTOR: Land use/cover sector)
 clearing_rate_index = (Conflict+soil_fertility+erosion_index+land_spec_index)/100
 Conflict = If Tenure_security =1 THEN 0 ELSE .03
 Original_Forest = 4E6
 percent_deforested = Deforested_SV/Total_forest
 Tenure_security = 1

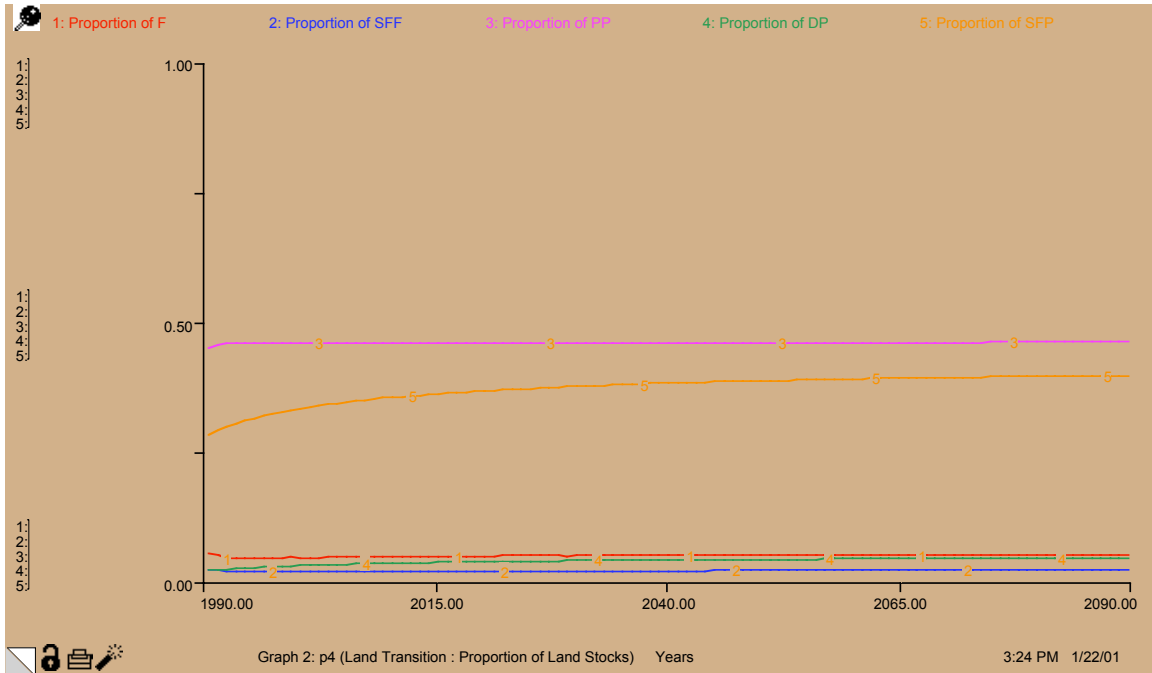

Appendix B. Proportion of land use under categories of Farm (F), Secondary Forest from Farm (SFF), Productive Pasture (PP), Degraded Pasture (DP) and Secondary Forest from Pasture (SFP).

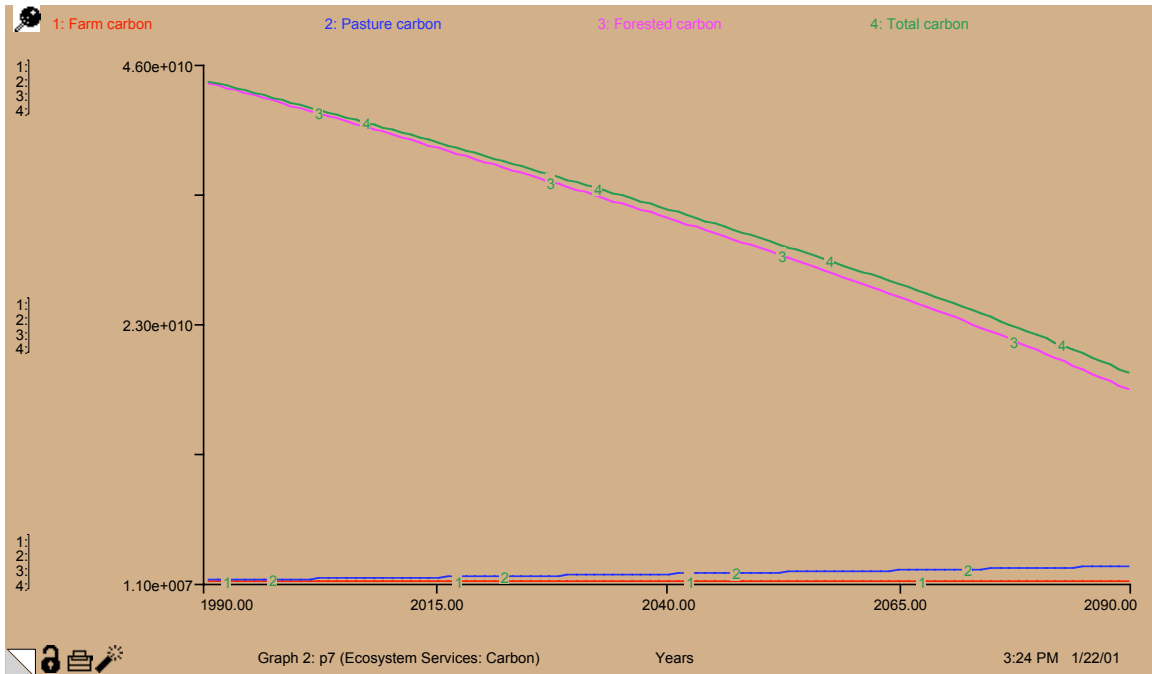

Appendix C. Carbon amounts (MT) on different land categories.

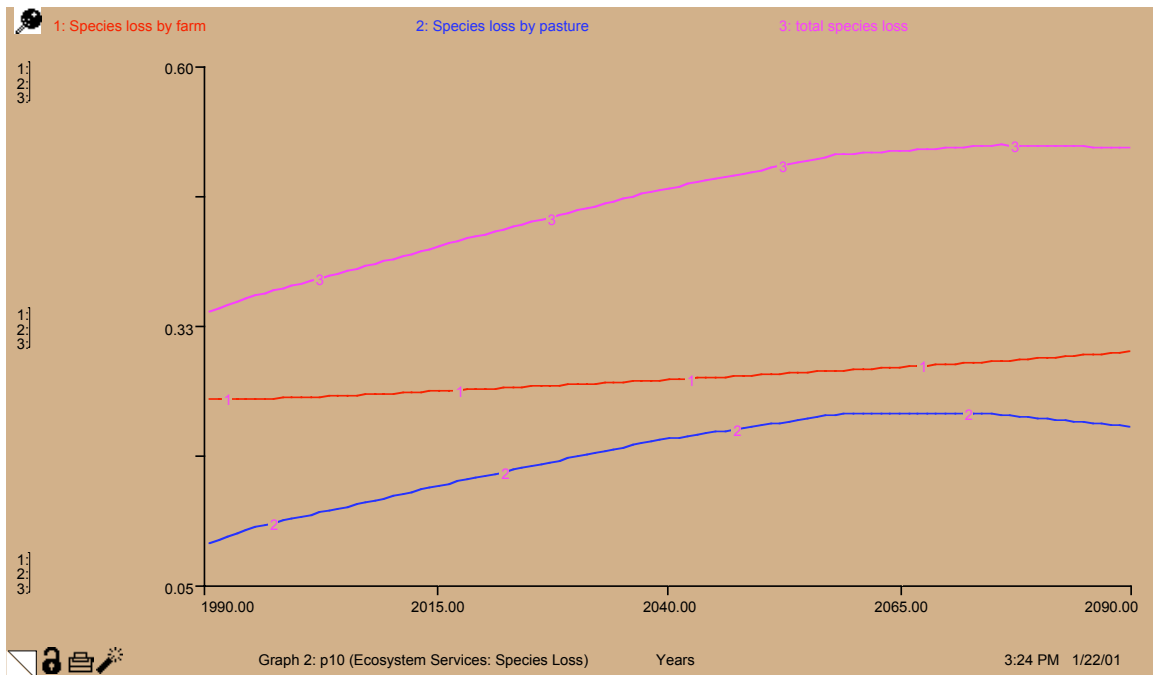

Appendix D. Erosion amounts (MT) on different land categories.

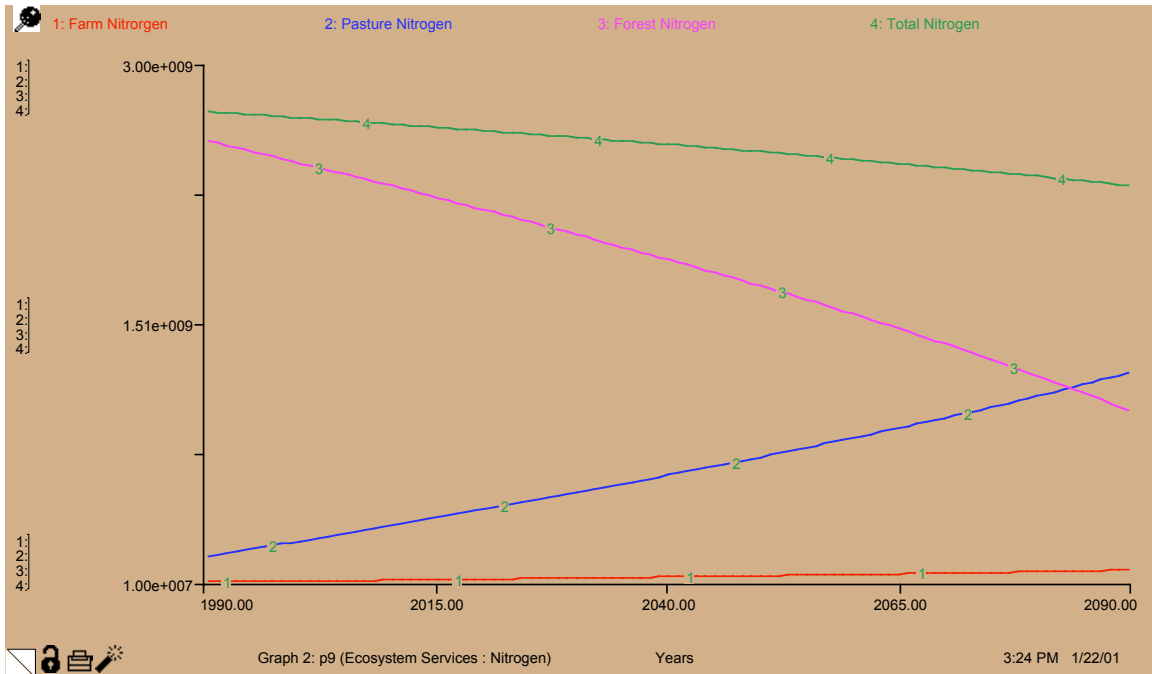

Appendix E. Nitrogen amounts (MT) on different land categories.

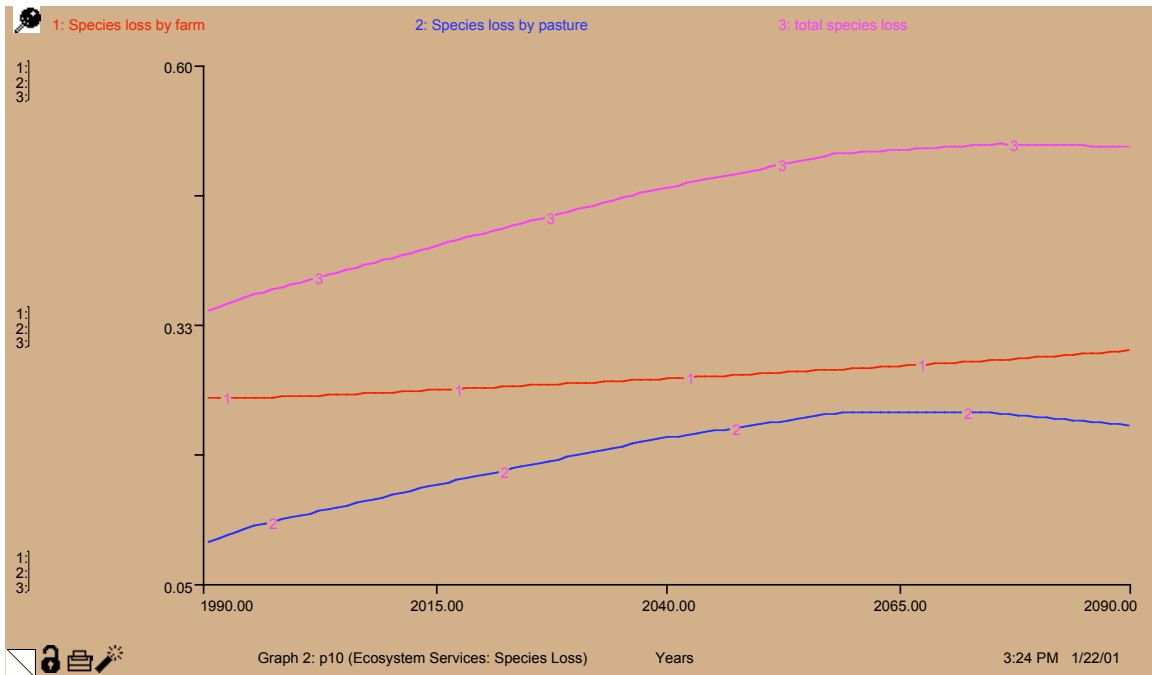

Appendix F. Species loss on different land categories.

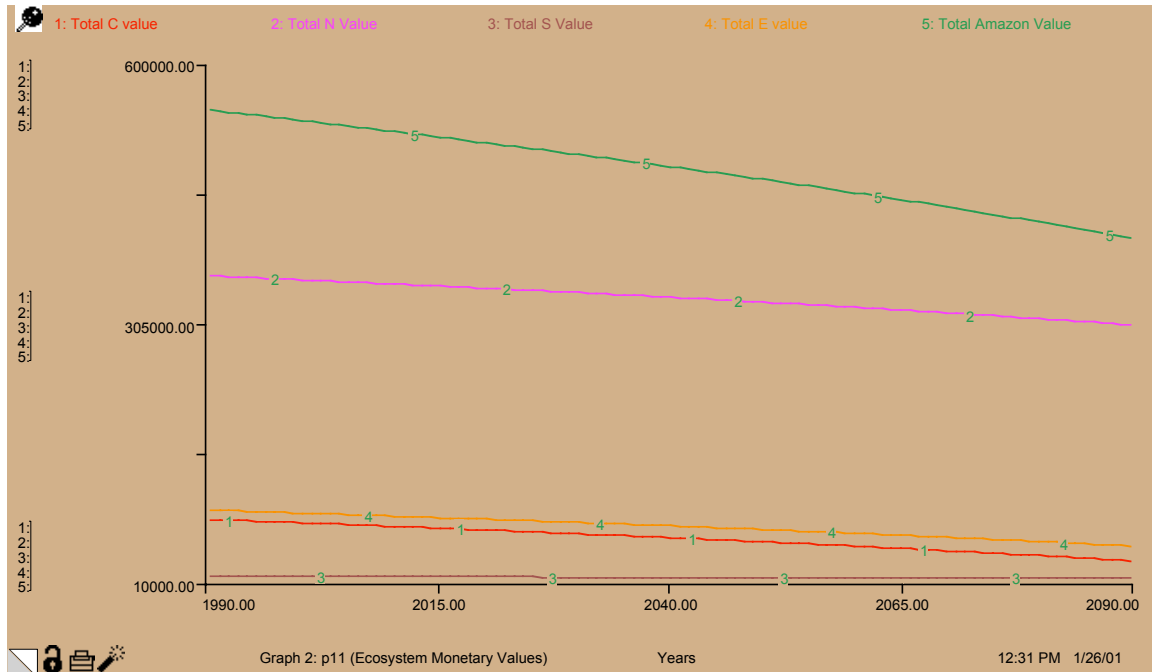

Appendix G. Total monetary value (US\$ \times 1E6) of different services in the Brazilian Amazon.

References:

Allen, J.C., 1985. Soil responses to forest clearing in the United States and the Tropics: Geological and Biological Factor. *Biotropica* 17: 15-27.

Almeida, O.T., Uhl, C., 1995. Developing a quantitative framework for sustainable resource-use planning in the Brazilian Amazonia. *World Development* 23: 1745-1764.

Attiwill, P.M., 1994. The Disturbance of forest ecosystems: The ecological basis for conservative management. *Forest Ecology and Management* 63: 247-300.

Ayanaba, A., 1976. The effects of clearing and cropping on the organic reserves and biomass of tropical forest soils. *Soil Biol. Biochem.* 8: 519-525.

Barbier, E. B., 1994. Natural Capital and the Economics of Environment and Development. In: Jansson, A.-M., Hammer, M., Folke, C. and R. Costanza (Editors). *Investing in Natural Capital*. Island Press. Washington, DC. 505 pp.

Brown, S., Lugo, A. E., 1992. Aboveground biomass estimates for tropical moist forests of the Brazilian Amazon. *Interciencia.* 17 (1): 8 -18.

- Brown, S., Lugo, A. E., 1984. Biomass of tropical forests: A new estimate based on forest volumes. *Science* 223: 1290-1293.
- Brown, S., Lugo, A. E., 1990. Effects of forest clearing and succession on the carbon and nitrogen content of soils in Puerto Rico and US Virgin Islands. *Plant and Soil* 124: 53-64.
- Chroeder, P.E. and J.K. Winjum, 1995. Assessing Brazil's carbon budget: I. Biotic carbon pools. *Forest Ecology and Management* 75:87-99.
- Costanza, R., Arge, R., Groot, R., Farber, S., Grasso, M., Hannon, B., Limburg, K., Naeem, S., O'Neill, R.V., Paruelo, J., Raskin, R.R., Sutton, P., van den Belt, M., 1997. The value of the world's ecosystems services and natural capital. *Nature* 387: 253-269.
- Cochrane, M.A, Alencar, A., Schulze, M.D., Soura Jr., C.M., Nepstad, D.C., Lefebvre, P., Davidson, E.A. 1999. Positive Feedbacks in the Fire Dynamic of Closed Canopy Tropical Forests. *Science* 284: 1832-1835.
- Crutzen, P.J., Andreae, M.O., 1990. Biomass burning in the tropics: impacts on atmospheric chemistry and biogeochemical cycles. *Science* 250: 1669-1678.
- Daily, G., 1997. Introduction. In: Daily, G. (Editor). *Nature's Services: Societal Dependence on Natural Ecosystems*. Island Press. Washington, DC. 392 pp.
- Dale, V.H., O'Neill, R.V., Pedlowski M., Southworth, F., 1993. Causes and effects of land-use change in central Rondonia, Brazil. *Photogrammetric Engineering and Remote Sensing*, 59: 997-1005.
- Dale, V. H., Pearson, S. M., Offerman, H. L. and R. V. O'Neill., 1994. Relating patterns of land-use change to faunal biodiversity in Central Amazon. *Conservation Biology* 8: 1027-1036.
- Eden, M.J., McGregor, D.F.M., Vieira, N.A.Q., 1990. III. Pasture development on cleared forest land in northern Amazonia. *The Geographical Journal* 156: 283-296.
- Erlich, P., Erlich, A., 1981. *Extinction. The Causes of the Disappearance of Species*. Random House, New York. 305 pp.
- Faminow, M.D., 1998. *Cattle, Deforestation, and Development in the Amazon: An economic, agronomic, and Environmental Perspective*. Cab International, New York. 253 pp.

- Fearnside, P.M., 1987. Causes of Deforestation in the Brazilian Amazon. In: Dickinson, R. (Editor). *The Geophisiology of Amazonia*. New York: John Wiley & Sons, pp. 175-224.
- Fearnside, P.M., 1992a. Forest Biomass in Brazilian Amazonia: Comments on the estimate by Brown and Lugo. *Interciencia*. 17 (1): 19 -27.
- Fearnside, P.M., 1992b. Greenhouse gas emissions from deforestation in the Brazilian Amazon. In: W. Makundi, W. , Sathaye, J. and O. Masera (Editors). *Carbon Emissions and Sequestratuon in Forests: Case Studies from Seven Developing Countries*. Rep. LBL - 31119, USEPA, Climate Change Division, Washington D.C. and Lawrence Berkeley Laboratory, Energy and Environment Division, Berkeley, CA.
- Fearnside, P.M., 1993. Deforestation in Brazilian Amazonia: The effect of population and land tenure. *Ambio*, 22: 537-545.
- Fearnside, P.M., 1996. Amazonian deforestation and global warming: Carbon stocks in vegetation replacing Brazil's Amazon Forest. *Forest Ecology and Management* 80: 21-34.
- Fearnside, P.M., 1997a. Environmental services as a strategy for sustainable development in rural Amazonia. *Ecological Economics*, 20: 53-70.
- Fearnside, P.M., 1997b. Greenhouse gases from deforestation in Brazilian Amazonia: net committed emissions. *Climatic Change* 35: 321-360.
- Fearnside, P.M, Guimarães, W.M., 1996. Carbon uptake by secondary forests in Brazilian Amazonia. *Forest Ecology and Management* 80: 35-46.
- Hall, A. L., 1986. More of the same in Brazilian Amazonia: A comment on Fearnside. *World Development* 14: 411-414.
- Hecht, S., 1983. Cattle Ranching in the Eastern Amazon: Environmental and Social Implications. In: Moran, E. F. (Editor), *The Dilemma of Amazonia Development*. Westview Press, Colorado.
- Hecht, S., 1985. Environment, development and politics: Capital accumulation and livestock sector in Eastern Amazonia. *World Development* 13: 663-684.
- Hecht, S., 1993. Landlessness, Land Speculation and Pasture-led Deforestation. In: Colchester, M. and L. Lohmann (Editors). *The Struggle for Land and the Fate of the Forests*. Penang: The World Rainforest Movement, pp. 164-178.

- Holling, C.S., 1996. The Resilience of Terrestrial Ecosystems: Local Surprise and Global Change, in W.C. Clark and R.E. Munn, eds., Sustainable Development of the Biosphere. Cambridge: Cambridge University Press, pp. 107-132.
- Hughes, R. Flint, J.B. Kauffman, Jaramillo, V.J., 1999. Biomass, Carbon, and Nutrient Dynamics of Secondary Forests in a Humid Tropical Region of Mexico. *Ecology*, 80: 1892-1907.
- INPE 1998. http://www.inpe.br/Informacoes_Eventos/amz/internet.html
- Laurance, W. F., Ferreira, L.V., Rankin-De Merona, J.M., Laurance, S.G., 1998a. Rain Forest Fragmentation and the Dynamics of Amazonian Tree Communities. *Ecology*, 79(6): 2032-2040.
- Laurance, W. F., Laurance, S. G., Delamonica, P., 1998b. Tropical Forest Fragmentation and Green house Gas Emissions. *Forest Ecology and Management* 110: 173-180.
- Lavelle, P., 1987. Biological processes and productive of soils in the humid tropics. In: Dickinson, R. E. (Editor). *The Geophysiology of Amazonia, Vegetation and Climate Interactions*. New York, Wiley & Sons. pp 196.
- Lawn, P.A., 2001. *Towards Sustainable Development: An Ecological Economics Approach*. Lewis Publishers. Boca Raton, FL. 462 pp.
- Lovejoy, T.E., 1980. A Projection of species extinction. In: Barney, G. O. (Editor). *The Global 2000 Report to the President. Entering the Twenty-First Century*. Council on Environmental Quality, U.S. Government Printing Office. Washington DC. pp 328-331.
- Lugo, A. E., 1988. Estimating Reductions in the Diversity of Tropical Forest Species. In: E. O. Wilson, ed. *Biodiversity*. Washington DC.
- Mahar, D., Schneider, R., 1993. Incentives for Tropical Deforestation. In Brown, K. and D. Pearce (Editors). *The causes of Tropical Deforestation: The economics and Statistical Analysis Giving Rising to the Loss of the Tropical Forests*. Vancouver, UBC Press.
- Mattos, M.M., Uhl, C., 1994. Economic and ecological perspectives on ranching in the Easter Amazon. *World Development* 22: 145-158.
- Monbiot, G., 1993. Land Ownership and the Flight to Amazonia. In Colchester, M., Lohmann, L. (Editors). *The Struggle for Land and the Fate of the Forests*. Penang: The World Rainforest Movement, pp. 139-163.
- Moran, E. F., 1991. Amazonian deforestation: Local causes and global consequences. In: Hansson, L. O. Jungen, B. (Editors). *Human Responsibilities and Global Change*.

- Proceedings from the International Conference in Goteborg 9-14 June, 1991. University of Goteborg, Section of Human Ecology, pp. 54-67
- Moran, E. F., Brondizio, E., Mausel, P., Wu, Y., 1994. Integrating Amazonian vegetation, land use, and satellite data. Attention to differential patterns and rates of secondary succession can inform future policies. *BioScience* 44: 329.
- Neil, C., Melillo, J. M., Steudler, P.A., Cerri, C.C., Moraes, J.F.L., Picolo, M.C., Brito, M., 1997. Soil organic carbon and nitrogen stocks following forest clearing for pasture in the Southwestern Brazilian Amazon. *Ecological Applications* 7: 1216-1225.
- Norgaard, R. B., 1989. Three dilemmas of environmental accounting. *Ecological Economics* 1: 303-314.
- Olson, J.S., Watts, J.A., Allison, L.J., 1983. Carbon in live vegetation of major world ecosystems. Rep. DOE/NBB-0037, US, Department of Energy, Office of Energy Research, Carbon Dioxide Research Division, Washington, D.C., 152pp.
- Pfaff, A.S.P., 1999. What drives deforestation in the Brazilian Amazon? Evidence from satellite and socioeconomic data. *Journal of Environmental Economics and Management* 37: 26-43.
- Peterson, G, Allen, C.R., Holling, C.S., 1998. Ecological Resilience, Biodiversity, and Scale. *Ecosystems*, 1: 6-18.
- Pyne, S.J., Andrews, P.L., Laven, R. D., 1996. Introduction to Wildland Fire. New York. Wiley & Sons. Inc. 769 pp.
- Reiners, W.A., Bouwman, A.F., Parsons, W.F., Keller, M., 1994. Tropical rain forest conversion to pasture: Changes in vegetation and soil properties. *Ecological Applications* 4: 363-377.
- Rocha, H.R., Nobre, C.A., Bonatti, J.P., Wright, I.R., Sellers, P.J., 1996. A vegetation-atmosphere interaction study for Amazonia deforestation using field data and a 'single column' model. *Quarterly Journal of the Royal Meteorological Society* 122: 567-594.
- Salati, E., 1987. The Forest and the Hydrological Cycle. In: R. Dickinson (Editor). *The Geophysiology of Amazonia*. New York: John Wiley & Sons, pp. 273-296.
- Salati, E., Nobre, C.A. 1991. Possible climatic impacts of tropical deforestation. *Climatic Change* 19: 177-196.
- Salati, E., Vose, P. B., 1984. Amazon Basin: A system in equilibrium. *Science* 225: 129-138.

- Saldarriaga, J.G., West, D.C., Tharp, M.L., Uhl, C., 1988. Long-term chronosequence of forest succession in the upper Rio Negro of Colombia and Venezuela. *Journal of Ecology* 76: 938-958.
- Salomao, R., Nepstad, D., Vieira, I.C., 1996. Como a biomassa de florestas tropicais influi no efeito estufa. *Ciencia Hoje* 21: 38-47.
- Serrao, E.A.S., Nepstad, D., Walker, R., 1996. Upland agricultural and forestry development in the Amazon: sustainability, criticality and resilience. *Ecological Economics* 18: 3-13.
- Shlesinger, W.H., 1991. The Lithosphere. In: *Biogeochemistry: An Analysis of Global Change*. Academic Press, New York. 588 pp.
- Shukla, J., Nobres, C., Sellers, P., 1990. Amazon deforestation and climate change. *Science* 247: 1322-1325.
- Skole, D., Tucker, C., 1993. Tropical deforestation and habitat fragmentation in the Amazon: Satellite data from 1978 to 1988. *Science* 260: 1905-1910.
- Tilman, D. 1994. Habitat Destruction and the Extinction Debt. *Nature*. 371: 65-66.
- Toniolo, A., Uhl, C., 1995. Economic and ecological perspectives on agriculture in the Eastern Amazon. *World Development* 23: 959-973.
- Uhl, C., Buschbacher, R., Serrao, E.A.S., 1988. Abandoned pastures in eastern Amazonia. I. Patterns of plant succession. *Journal of Ecology* 76: 663-681.
- Uhl, C., 1987. Factors controlling succession following slash-and-burn agriculture in Amazonia. *Journal of Ecology* 75: 377-407.
- Vitousek, P.M., 1984. Litterfall, nutrient cycling, and nutrient limitation in tropical forests. *Ecology* 65: 285-298.
- Vitousek, P.M., Mooney, H.A., Lubchenco, J., Melillo, J.M., 1997. Human Domination of Earth's Ecosystems. *Science* 277: 494-499.
- Walker, R., Moran, E., Anselin, L., 2000. Deforestation and cattle ranching in the Brazilian Amazon: External capital and household processes. *World Development* 28: 683-699.
- Werner, P. 1984. Changes in soil properties during tropical wet forest succession in Costa Rica. *Biotropica* 16: 43-50.

Wood, C.H., Perz, S.G., 1996. Population and Land-Use Changes in the Brazilian Amazon. In: Ramphal, S. and S. W. Sinding (Editors). Population Growth and Environment. Praeger Publishers, Westport, CT.

Wilson, E.O. 1991. The Diversity of Life. Harvard University Press. Cambridge, Mass. 424 pp.

Zhang, H., Henderson-Sellers, A., 1996. Impacts of tropical deforestation. Part I: Process Analysis of local climatic change. *Journal of Climate* 9: 1497-1517.

Zhang, H., McGuffie, K., Henderson-Sellers, A., 1996. Impacts of tropical deforestation. Part II: The role of large-scale dynamics. *Journal of Climate* 9: 2498-2521.

APPENDIX B: Modeling the Dynamics of the Integrated Earth System and the Value of Global Ecosystem Services Using the Gumbo Model

“Reprinted from *Ecological Economics*, 41, Boumans, R., Costanza, R., Farley, J., Wilson, M. A., Rotmans, J., Villa, R., Portela, R., Grasso, M., Modeling the Dynamics of the Integrated Earth System and the Value of Global Ecosystem Services Using the GUMBO Model, 529-560, Copyright (2002), with permission from Elsevier”.

Ecological Economics 41 (2002) 529 - 560

Modeling the Dynamics of the Integrated Earth System and the Value of Global Ecosystem Services Using the GUMBO Model

Roelof Boumans, Robert Costanza, Joshua Farley, Matthew A. Wilson, Jan Rotmans*,
Ferdinando Villa, Rosimeiry Portela, and Monica Grasso

Institute for Ecological Economics, University of Maryland, Solomons, MD 20688, USA
Marine, Estuarine and Environmental Science Program, University of Maryland, College Park, MD, 20742,
USA

International Center for Integrative Studies, Maastricht University, 6200, MD Maastricht, The Netherlands
Independent Consultant, 239 Rawson Road, #5, Brookline, MA, 02446, USA

Abstract

A Global Unified Metamodel of the BiOsphere (GUMBO) was developed to simulate the integrated earth system and assess the dynamics and values of ecosystem services. It is a “metamodel” in that it represents a synthesis and a simplification of several existing dynamic global models in both the natural and social sciences at an intermediate level of complexity. The current version of the model contains 234 state variables, 930 variables total, and 1715 parameters. GUMBO is the first global model to include the dynamic feedbacks among human technology, economic production and welfare, and ecosystem goods and services within the dynamic earth system. GUMBO includes modules to simulate carbon, water, and nutrient fluxes through the *Atmosphere*, *Lithosphere*, *Hydrosphere*, and *Biosphere* of the global system. Social and economic dynamics are simulated within the *Anthroposphere*. GUMBO links these five spheres across eleven biomes, which together encompass the entire surface of the planet. The dynamics of ten major ecosystem services for each of the biomes are simulated and evaluated. Historical calibrations from 1900 to 2000, and a range of future scenarios representing different assumptions about future technological change, investment strategies and other factors have been simulated. The relative value of ecosystem services in terms of their contribution to supporting both conventional economic production and human well-being more broadly defined were estimated under each scenario, and preliminary conclusions drawn. The value of global ecosystem services was estimated to be about 4.5 times the value of Gross World Product (GWP) in the year 2000 using this

approach. The model can be downloaded and run on the average PC to allow users to explore for themselves the complex dynamics of the system and the full range of policy assumptions and scenarios.

1. Introduction

There is now a relatively long history of global computer simulation modeling, starting in the 1970s with the World2 (Forrester 1971) and World3 models (Meadows et. al. 1972, 1975). Since then the field has expanded greatly, owing partly to the increasing availability and speed of computers and to the rapidly expanding global data base that has been created in response to increased interest in global climate change issues (Meadows 1985, Meadows et. al. 1992, Nordhaus 1994, Rotmans and de Vries 1997; IPCC 1992, 1995, 2001). Collectively, global models constitute a relatively well focused and coherent discussion about our collective future. As Meadows (1985) has pointed out:

“Global models are not meant to predict, do not include every possible aspect of the world, and do not support either pure optimism or pure pessimism about the future. They represent mathematical assumptions about the interrelationships among global concerns such as population, industrial output, natural resources, and pollution. Global modelers investigate what *might* happen if policies continue along present lines, or if specific changes are instituted” (Meadows 1985, p. 55; Italics added).

The Global Unified Metamodel of the BiOsphere (GUMBO), which we describe in this paper, builds on the long tradition of global modeling and the rapidly expanding global data base.

GUMBO addresses the following key objectives:

- To model the complex, dynamic interlinkages between social, economic and biophysical systems on a global scale, focusing on ecosystem goods and services and their contribution to sustaining human welfare.
- To create a computational framework and data base that is simple enough to be distributed and run on a desktop PC by a broad range of users. GUMBO was constructed in STELLA, a popular icon-based dynamic simulation modeling language (<http://www.hps-inc.com>), and the full model can be downloaded and run using the free run-time only version of STELLA.

In designing GUMBO we sought to provide a flexible computational platform for the simulation of alternative global pasts and futures envisioned by diverse end-users. GUMBO limits historical parameter values to those which produce historical behavior consistent with historical data. It then allows one to make explicit assumptions about future parameter or policy changes, or to determine what assumptions are required to achieve a specific future. It is then possible to assess how plausible those assumptions are, and to consider policy options that might make the assumptions required for a desired future more likely to occur. By allowing the user to change specified parameters within GUMBO and generate alternative images of the future we hope to provide a tool that will both stimulate dialogue about global change and generate a more complete understanding of the complex interrelationships among social and economic factors, ecosystem services, and the biophysical earth system. This dialogue is needed in order to achieve sustainable development on a global scale.

GUMBO is unique among global models in three important ways:

- (1) ecosystem services are a focus of GUMBO and explicitly affect both economic production and social welfare. This allows the model to calculate dynamically changing values for ecosystem services based on their marginal contributions relative to other inputs into the production and welfare functions.
- (2) both ecological and socioeconomic changes are endogenous to the model, with a pronounced emphasis on interactions and feedbacks between the two – all other global models to date limit either ecological or socioeconomic change to exogenously determined scenarios (c.f. Meadows et. al 1992; Rotmans and de Vries 1997, IPCC 2001);
- (3) the model includes natural capital, human capital, social capital and built capital as state variables and factors of production, and distinguishes between material factors and factors of transformation (material cause and efficient cause, in Aristotelian terms). Thus, the model allows limited substitution between factors of production at the margin, but also imposes strong sustainability constraints for the system as a whole¹.

This paper first describes the general structure and behavior of GUMBO, along with limitations and caveats (the full model and documentation can be downloaded from: <http://iee.umces.edu/GUMBO>). It then presents results from a few alternative scenarios

¹ Weak sustainability requires that the future be left a constant amount of capital, but assumes more of one type of capital can always substitute for less of another. Strong sustainability, on the other hand, requires that the future be left constant amounts of natural capital (the material means of production), while allowing substitution among social capital, built capital and human capital (the efficient means of production, or agents of transformation).

developed using contrasting assumptions about technology, the resilience of the global environmental system and the ability of economic production to cope with future changes in sinks and sources of natural capital. For each scenario, we examine the dynamics of the values of ecosystem services to assess which ecological variables impose the tightest constraints on production and welfare. We also discuss the plausibility of the assumptions necessary to bring about each scenario, and the level of risk implied in planning futures around each scenario.

2. Model development

GUMBO consists of five distinct modules or “spheres”: the Atmosphere, the Lithosphere, the Hydrosphere, the Biosphere, and the Anthroposphere (Figure 1). It is further divided into eleven biomes or ecosystem types which encompass the entire surface area of the planet: *Open Ocean, Coastal Ocean, Forests, Grasslands, Wetlands, Lakes/Rivers, Deserts, Tundra, Ice/rock, Croplands, and Urban*. (See Figure 1) These eleven biomes represent an aggregation of the sixteen biomes used in Costanza et al (1997a). Their relative areas change in response to urban and rural population growth, Gross World Product (GWP), and changes in global temperature. Among the spheres and biomes, there are exchanges of energy, carbon, nutrients, water and mineral matter.

GUMBO is the first global model to explicitly account for ecosystem goods and services and factor them directly into the process of global economic production and human welfare development. Ecosystem services contribute to human quality of life in numerous ways. First, such services provide critical life-support systems for humans and all other species. Second, all sustainable production processes require renewable

resource inputs. By creating the conditions essential for the reproduction of all forms of life, ecosystem services also provide the material means for sustainable economic production. Third, ecosystem services create the conditions necessary for cultivated natural capital, such as agriculture, aquaculture and silviculture. Ecosystem services also contribute directly to human well-being (Daily 1997, Costanza et al. 1997a). In GUMBO, ecosystem services are aggregated to 7 major types, while ecosystem goods are aggregated into 4 major types. Ecosystem services, in contrast to ecosystem goods, cannot accumulate or be used at a specified rate of depletion. Ecosystem services include: soil formation, gas regulation, climate regulation, nutrient cycling, disturbance regulation, recreation and culture, and waste assimilation. Ecosystem goods include: water, harvested organic matter, mined ores, and extracted fossil fuel. These 10 goods and services represent the output from natural capital, which combines with built capital, human capital and social capital to produce economic goods and services and social welfare.

Below we briefly describe the major “sectors” in the GUMBO model. The atmosphere and anthroposphere are considered to be globally homogenous in this version. The other sectors (lithosphere, hydrosphere, and biosphere) are divided into 11 biomes and the structure described is replicated for each biome. In addition, there are sectors in the model for ecosystem services, land use, and the model’s data base. In what follows, we briefly describe the important processes and structure in each sector and display the STELLA diagram for the sector to indicate how the elements are connected. In these diagrams, boxes represent state variables, double arrows represent fluxes in and out of state variables, single arrows represent information flows or other functional

connections, and circles represent auxiliary variables. The full model with equations and documentation is available for download at: <http://iee.umces.edu/GUMBO>.

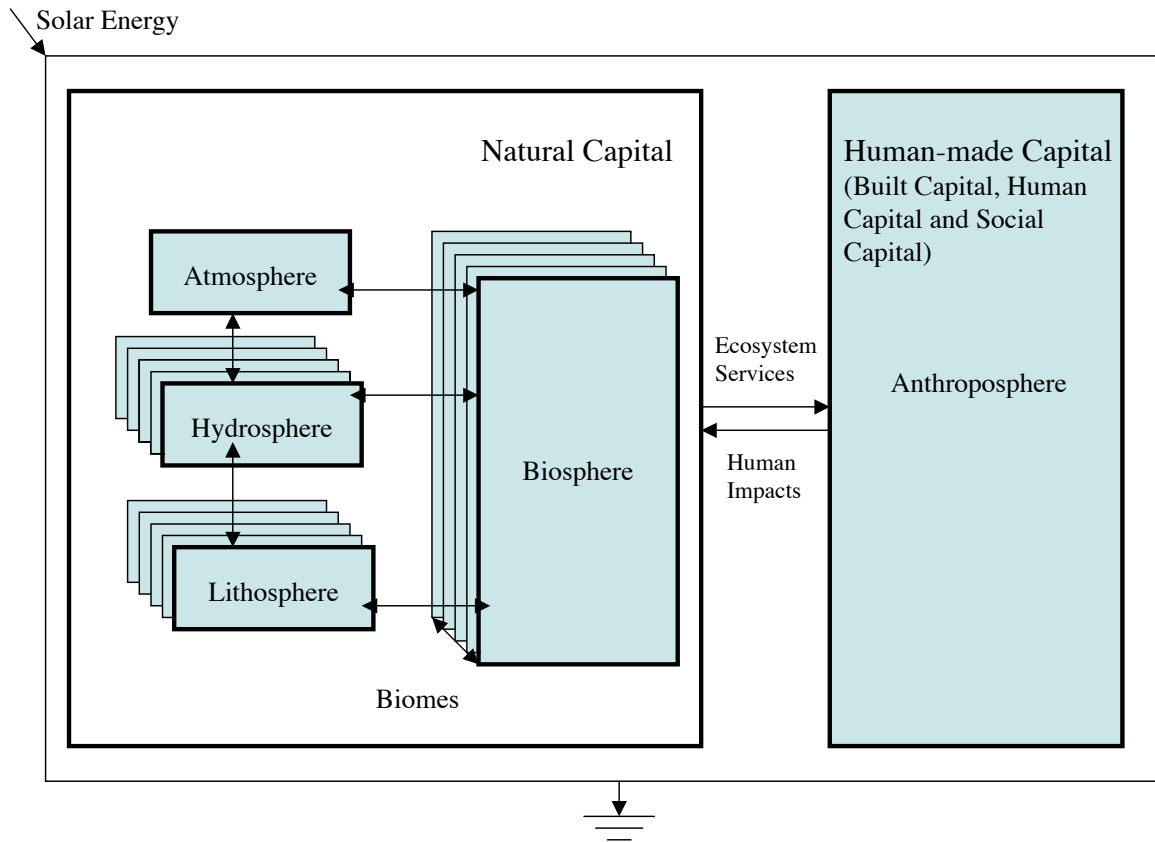

Fig. 1. Basic structure of GUMBO. The hydrosphere, lithosphere, and biosphere are reproduced for each of 11 biomes. STELLA diagrams to indicate the general complexity of the structure of each sphere are given in Figs. 2 – 9. The full model and equations are available for download at <http://iee.umces.edu/GUMBO>.

2.1 The atmosphere

The atmosphere module in GUMBO (Figure 2) facilitates exchanges of carbon, water, and nutrients across biomes. The atmosphere also accounts for global energy balances. Atmospheric dynamics are calibrated against two important global and related indicators: atmospheric carbon and global temperature.

Source and sink functions of atmospheric carbon are linked to all other spheres. For example, carbon exchange with the biosphere depends on the rates at which carbon is lost to the atmosphere from burning and decaying plant material as well as the rates of carbon removal from the atmosphere through vegetation growth (Houghton et al., 1987). Carbon exchange with the lithosphere occurs through degassing from volcanic activity, and the accumulation and oxidation of organic soil matter (Houghton et al. 1987). The net carbon flux between the atmosphere and the hydrosphere results from partial pressure differences between air and water. Carbon input from the anthroposphere to the atmosphere is primarily the result of fossil fuel combustion and cement production.

Sources and sinks of atmospheric water are evaporation and precipitation in the hydrosphere and transpiration within the biosphere. Sources of atmospheric nutrients, primarily various types of nitrogen oxides, are introduced from biomass oxidation in the biosphere and fossil fuel combustion within the anthroposphere. Atmospheric nutrient sinks are ocean sea spray and wet precipitation in the hydrosphere and dry deposition in the lithosphere.

Global energy accounting was adapted from a model created by Few (<ftp.usra.edu/pub/esse/DROP/outgoing/stella/few/energymod3.stm>) in order to simulate energy budgets for each biome at 1-year time steps. We introduced spatial energy diffusion fluxes to account for heat exchanges across biomes. Incoming solar energy is proportional to a solar radiation constant and a biome specific albedo. Energy radiation into space is proportional to biome-specific properties for heat retention and imperfect emissivity. Energy exchanges between biomes take into account temperature differences and time constraints for energy transport.

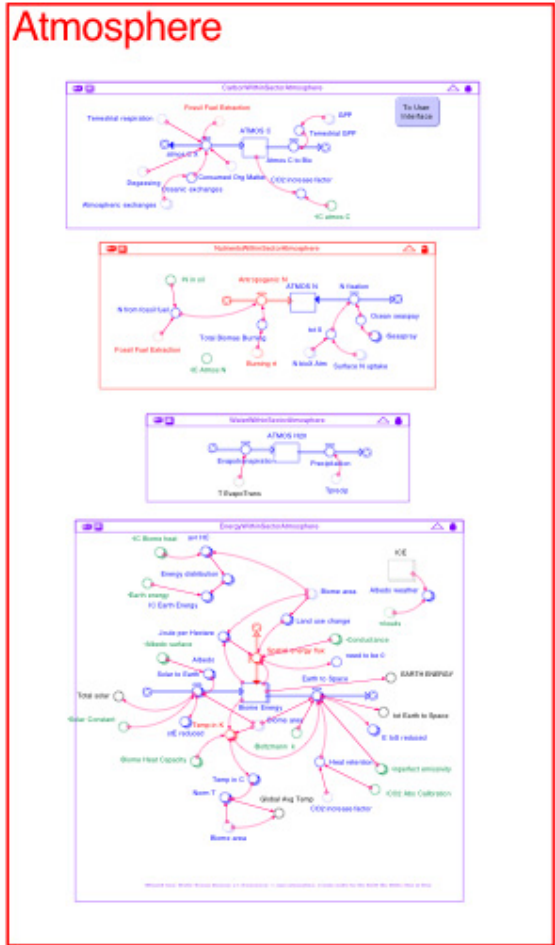

Fig. 2. STELLA diagram of the Atmosphere sector.

2.2 The lithosphere

The GUMBO lithosphere (Figure 3) represents the solid uppermost shell of the earth, which includes soils and deposited sediments. Lithosphere stocks are represented by silicate rocks, carbon reserves, and ore and fossil fuel deposits in rock and soil. Fluxes between rocks and soils are from weathering and sedimentary deposition (burial). New silicate rock is formed and lost by the slow rates of ocean spreading and seafloor subduction. Weathering causes an overall decay of carbon, silicate rocks and ore deposits and forms soils through interaction with the biosphere. A specified 'burial rate' converts carbon, silicates and ores back into sedimentary rocks and accounts for biome-specific recycling rates.

2.3 The hydrosphere

The GUMBO hydrosphere (Figure 4) accounts for biome-specific stocks of water, carbon, and "generic nutrients" in surface and subsurface water bodies. Surface storage occurs in ice and surface water, subsurface storage occurs in deep water, fossil water and unsaturated water (soil moisture). Storage of carbon and nutrients in the hydrosphere occur in surface water, terrestrial groundwater and oceanic surface and deep water. Average biome temperature determines the nature of precipitation. Fluctuating biome temperatures from the atmospheric energy module regulate the water exchange between ice and surface waters. Surface water exchanges between continental and oceanic biomes are calculated to compensate for uneven distributions among biome-specific evapotranspiration. Additional fresh water is available as "fossil water" stored in geological deposits and does not normally have free exchange with surface waters. GUMBO allows the mining of fossil water as a reaction to shortages in surface water due

to the demand for water generated in the anthroposphere. Biome-specific stocks of nutrients are exchanged with the atmosphere (e.g. nitrogen fixation and denitrification), the lithosphere (e.g. erosion and sedimentary processes), and the biosphere (e.g. mineralization and plant uptake).

2.4 The biosphere

The biosphere is a self-regulating system sustained by large-scale cycles of energy and of materials such as carbon, oxygen, nitrogen, certain minerals, and water. The fundamental processes are photosynthesis, respiration, and the fixing of nitrogen by certain bacteria. Sources of carbon to the GUMBO biosphere (Figure 5) are atmospheric and hydrospheric carbon fixed by autotrophs through photosynthesis. Autotrophic carbon is partially fluxed into consumers and partially into dead organic matter. Consumer carbon continues its course into dead organic matter, which is further cycled through a decomposer stock. Biospheric carbon is released into the atmosphere or hydrosphere through respiration from the autotrophs, consumer and decomposer stocks. Accelerated carbon flux from the biosphere to the atmosphere is moderated by forces within the anthroposphere and occurs when autotrophs and consumers are harvested and consumed by humans. Harvested carbon is immediately released back into the atmosphere as waste, stored into built capital like roads or homes, or reapplied towards reforestation. A small fraction of the carbon in the biosphere that resides in the dead organic matter is fluxed towards soil formation and ultimately towards the formation of carbon deposits in rock.

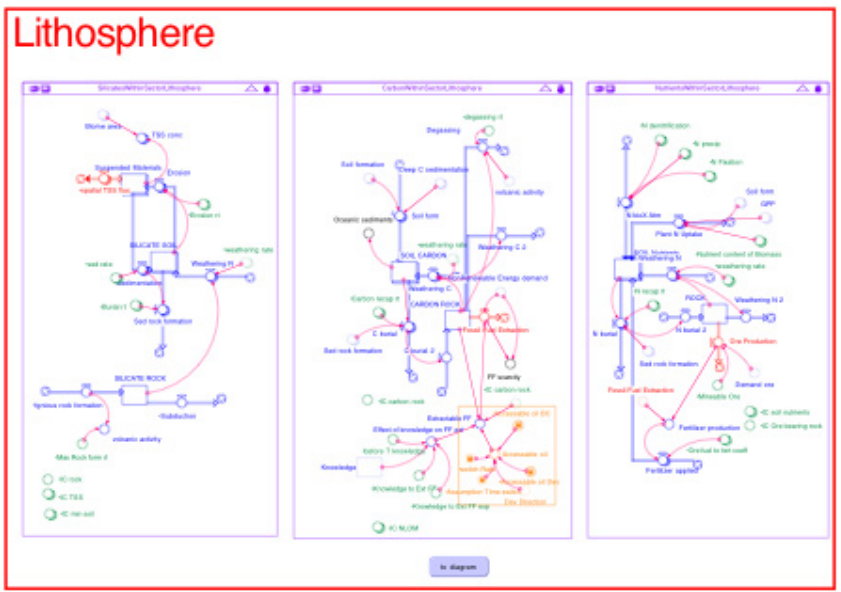

Fig. 3. STELLA diagram of the Lithosphere sector

Hydrosphere

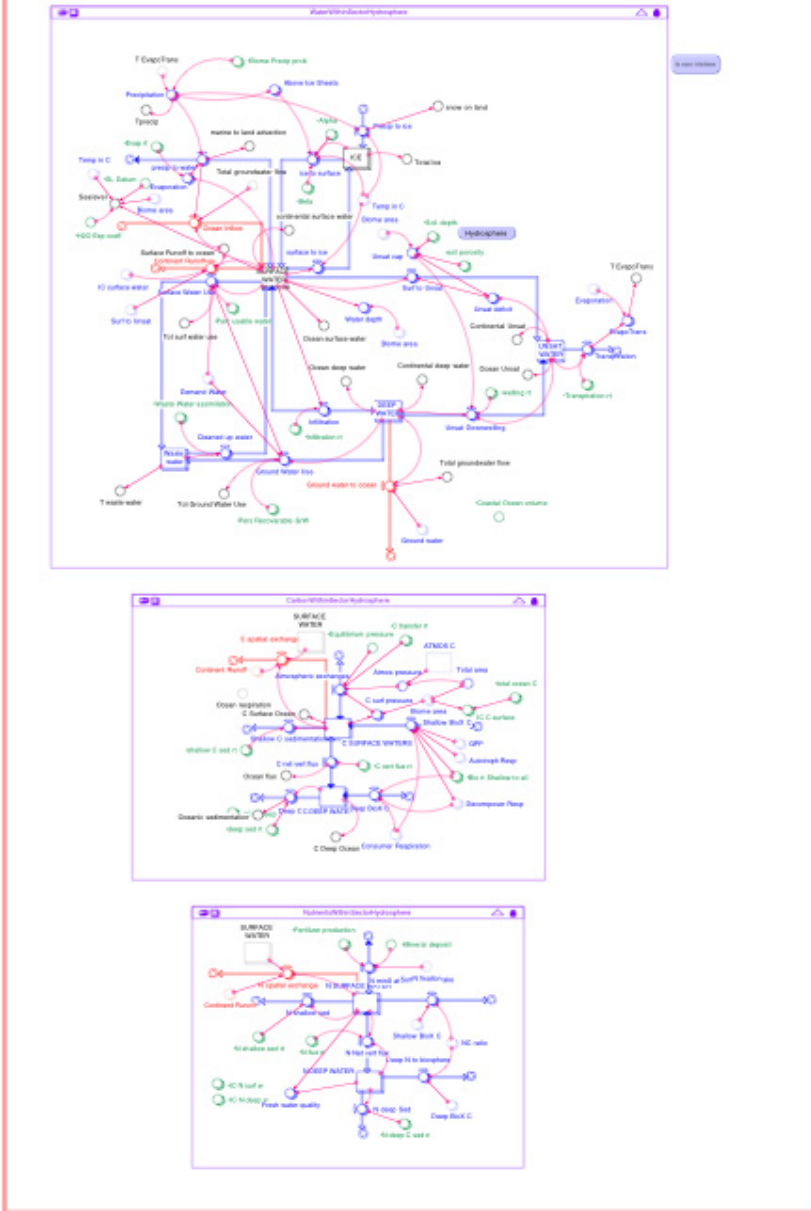

Fig. 4. STELLA diagram of the Hydrosphere sector

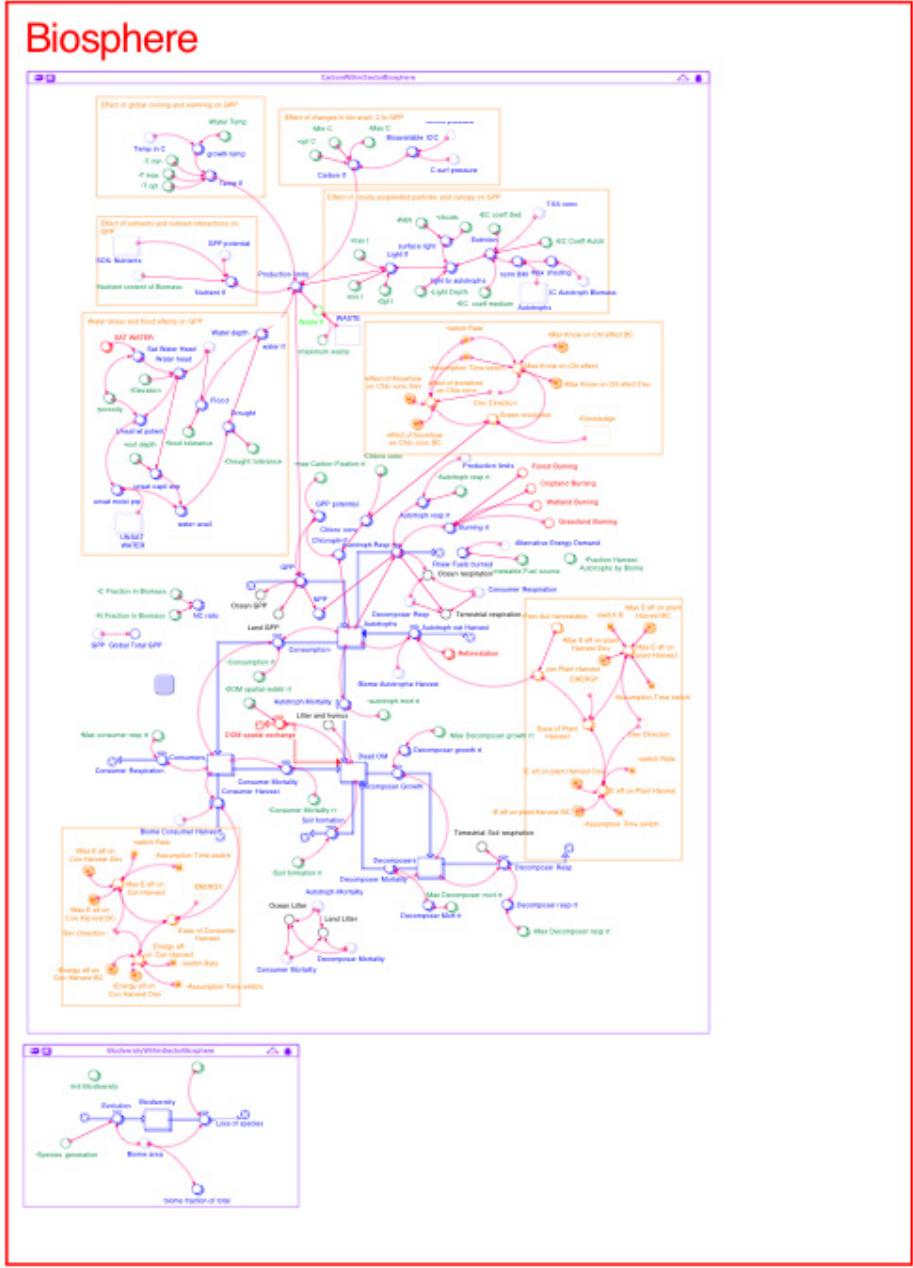

Fig. 5. STELLA diagram of the Biosphere sector

Many of the ecosystem services provided by the biosphere are associated with the rate of photosynthesis or productivity of autotrophs. Important factors for achieving optimum productivity are the nutrient availability in the lithosphere, temperature, light levels, and carbon pressure in atmosphere, soil moisture in the hydrosphere and waste levels generated within the anthroposphere.

2.5 The anthroposphere

The anthroposphere in GUMBO (Figure 6) represents human social and economic systems. The anthroposphere harvests large amounts of material and energy from the larger system and discards waste at each phase along a production chain. In contrast to the larger biosphere, only a very small portion of materials are internally recycled within the anthroposphere. Human population, knowledge and social institutions, rules and norms drive the rate of this material and energy flux.

The anthroposphere is the nexus of valuation in GUMBO. The anthroposphere brings together the numerous *elements* within the other spheres that affect human well-being, links them to human *activities* that affect well-being, and assesses the *impacts* of human activity on those elements. There are two distinct types of value we measure. First, GUMBO calculates the contribution of the elements, activities and impacts to the production of goods and services (Gross World Product, or GWP). Second, GUMBO calculates the contribution of the elements, activities and impacts to our sustainable social welfare (SSW) function or quality of life. Both economic production and human welfare are modeled with a Cobb-Douglas function, as follows:

$$GWP = HK^{\alpha_1} \cdot SK^{\alpha_2} \cdot BK^{\alpha_3} \cdot W^{\alpha_4} \cdot \prod_{i=1}^{10} NK_i^{\alpha_{i+4}}$$

and

$$SSW = BK^{\beta_1} \cdot C^{\beta_2} \cdot \prod_{i=1}^7 NK_i^{\beta_{i+2}} \cdot HK^{\beta_{10}} \cdot SK^{\beta_{11}} \cdot W^{\beta_{12}} \cdot M^{\beta_{13}}$$

where:

α_n and β_n are the percentage increases in levels of output (GWP or SSW, respectively) arising from a one-percent increase in the corresponding input. Inputs are: HK= human capital (technology and labor), SK=social capital (social networks and institutions), BK= built capital (buildings, roads, etc.), W=waste (waste products of depreciated capitals and consumption), C=consumption (non-invested GWP), NK=natural capital (disaggregated into the 10 ecosystem goods and services), and M=mortality. The coefficients on waste, α_4 and β_4 , and Mortality β_{13} are negative, while all others are positive. The α_i and β_i parameters are different for the production and welfare function. Differences between the production and welfare functions are that the welfare function (1) includes only ecosystem services (not ecosystem goods like fossil fuel); and (2) it also includes C (which is a percentage of the production function), and M (average human death rate as an indicator of human health). Thus the welfare function includes the welfare derived from production (via consumption) plus the welfare derived directly from the non-marketed ecosystem services, social capital, built capital, and human capital, and the negative influences on welfare of waste and mortality. Distribution effects on welfare are included through the influence of social capital (Putnam 2000).

While the α_i parameters in the production function can be calibrated to fit GWP data, values of the β_i parameters in the welfare function are, of course, matters of individual preference, which are themselves moderated through culture and world view.

Anthroposphere

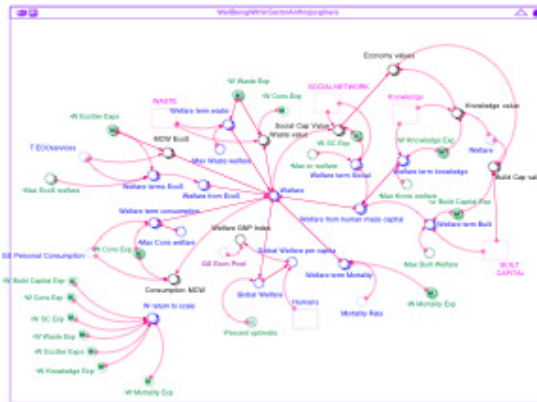
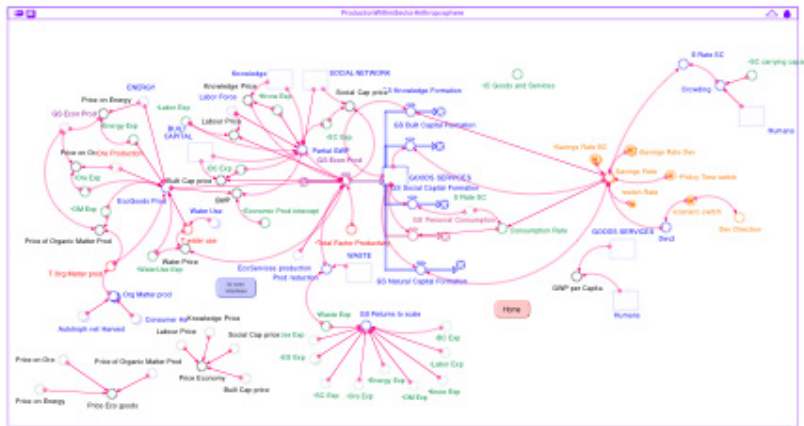

Fig. 6. STELLA diagram of the Anthroposphere sector

In GUMBO we allow the user to experiment with these weights and/or to change them to better reflect their own preferences. In the results we report later, we have used the weights shown in Table 1, which divides the global population into technological “optimists” and “skeptics” (Costanza 2000). The world is then made up of some (potentially time varying) percentage of each type. In the current run, we assume 20% optimists (mainly populating the developed world) and 80% skeptics. The optimists give more weight to built capital, consumption, and individual knowledge, and less to natural capital and waste. Both weigh social capital and mortality equally.

Table 1. β_i parameters in the SSW function for this run for technological optimists and skeptics.

SSW function parameters (β_i)	Optimist	Skeptic
1. Built Capital	0.25	0.01
2. Consumption	0.25	0.01
3. Gas regulation,	0.01	0.05
4. Climate Regulation	0.01	0.05
5. Disturbance Regulation	0.01	0.05
6. Soil Formation	0.01	0.05
7. Nutrient Cycling	0.01	0.05
8. Waste Treatment	0.01	0.05
9. Recreational & Cultural	0.04	0.10
10. Knowledge	0.35	0.10
11. Social Capital	2.00	2.00
12. Waste	-0.01	-0.50
13. Mortality	-0.20	-0.20

The Cobb-Douglas function adopted here is among the most widely used functions in economic modeling for a number of reasons. First the marginal product of each input is positive and decreasing. That is, more of any input will always lead to more output, but each additional unit of input produces less additional output than the preceding one, if other inputs are held constant. Second, it allows for substitution

between inputs. Third, and probably most importantly, it is mathematically tractable and log linear, leading to ease of estimation and manipulation (Bairam, 1994).

A limitation of the Cobb-Douglas function in some models is that it allows a virtually infinite substitution of inputs. As long as no input goes to zero, more of any input can always substitute for less of another. This is equivalent to the notion of weak sustainability, which assumes that more built (or social or human) capital can always substitute for less natural capital. However, there are powerful arguments for assuming strong sustainability (i.e. beyond some threshold built, human or social capital cannot substitute for natural capital). For example, no number of fishing boats can substitute for drastically depleted fish stocks. But the GUMBO model is a *systems* model that captures the feedbacks between the use of capital stocks in the production function and the production of the capital stocks themselves. In GUMBO the notion of strong sustainability is thus explicitly built in, because natural capital is an essential input to all other forms of capital. There is no economic “production” in the model, only transformation. Natural capital is the material transformed, while built, social and human capital are the agents of transformation. Thus, while more built capital, social capital or human capital can substitute for less natural capital in the production of GWP or SSW at the margin in the production function, these capitals cannot be produced without natural capital. Thus natural capital is fundamentally a complement to the other capitals in the production process. Further, if natural capital falls below a certain level, or if waste emissions reach excessive levels, natural capital loses the ability to regenerate in the model, and begins a spontaneous decline. Once such a threshold is passed, natural capital

can fall to zero, at which point production could fall to zero regardless of the level of other inputs. This approach effectively models the principles of strong sustainability.

The GUMBO framework permits the quantitative aggregation of ‘factors of production’ contributing to both GWP and SSW into four distinct types of capital stocks: *natural capital*, *social capital*, *human capital* and *built capital* (see Berkes and Folke 1994; Serageldin 1996; Costanza et. al. 1997b).

2.6 Natural capital

Natural capital aggregates all the biophysical stocks which produce both ecosystem goods (raw materials and mineral resources) and ecosystem services. Both ecosystem goods and services contribute to both GWP and SSW. Ecosystem goods are the only source of material means, and hence are essential inputs into all production processes, human or natural, but also contribute directly to our quality of life independent of their contribution to production. Unlike the other forms of capital, natural capital is capable of reproduction on its own with no human intervention. Thanks to the steady inflow of solar energy, it is possible to invest in renewable natural capital simply by using it up slower than it replenishes itself. It is also possible to actively invest in natural capital through ecological restoration, or to cultivate natural capital with inputs of human, social and built capital. Within GUMBO, we invest goods and services in natural capital by reducing consumption and/or direct investment via ecosystem protection and restoration efforts.

2.7 Social capital

Social capital refers to the institutions, relationships, and norms that shape the quality and quantity of a society's social interactions. Social capital is not just the sum of the institutions that underpin human society; it is the glue that holds them together (<http://www.worldbank.org/poverty/scapital/whatsc.htm>). Social capital reduces transaction costs via cooperation and makes social and economic interactions possible. It is thus an essential element in virtually all economic production, but that is only a part of the benefit it provides as it contributes directly to SSW. Humans are innately social creatures, and human relationships, trust and community are essential components of our SSW. While social capital can depreciate, it does not wear out through use. Indeed, it would seem that using social capital probably increases it, while neglecting it leads to its decay. However, it is also likely that building excess social capital within a group (bonding) can make it more difficult to establish social capital between groups (bridging) (Putnam 2000). While seemingly immaterial, social capital cannot, of course, exist without people, human contact, and appropriate infrastructure, all of which require material inputs.

2.8 Human capital

Human capital consists of both quantity and quality of technology, knowledge and labor. As a critical factor in the quality of labor, health is also a component of human capital. Production of any sort is impossible without labor and knowledge. Human capital in the form of acquired knowledge, skills and physical health further contributes to our SSW. An education, it has been said, makes your mind a better place to spend your leisure time. Skills and knowledge instill pride and status, and offer greater

opportunities for less dangerous, more fulfilling employment. And few would deny that health plays an important role in SSW.

In GUMBO, human technology is represented simply as the overall stock of human knowledge. As such, human capital can depreciate if not used, or it can be stored in various formats. Each of these formats, of course, requires material and energy to create and maintain, and hence requires continual investment in order not to depreciate. Future generations must also be trained in how to access and use this stored information. In addition, as new knowledge accumulates, older knowledge often becomes obsolete, which is also a form of depreciation.

2.9 Built capital

Built capital and labor have traditionally received the greatest attention in economic analysis. No explanation is necessary concerning how built capital contributes to GWP and how it requires resources for creation and maintenance. While built capital also contributes directly to SSW (the sole purpose of any aesthetic architectural embellishments, for example), it may play a less important role than is often assumed (Frank 1999). Built capital continues to play a major role, however, in the depletion of resources, and in the current economic system ownership of built capital strongly influences the distribution of wealth. Of all the capitals, investment in built capital places the most demands on natural resources. Built capital depreciates by physically falling apart, or else as the result of new technologies making existing infrastructure obsolete.

All four types of capital, as well as energy, are required for the production of GWP and SSW within the anthroposphere even though they make different contributions to each. In GUMBO, accumulated waste reduces the output of both GWP and SSW. Consumption contributes to SSW. Human, social and built capital stocks spontaneously depreciate, while natural capital is renewable and has the potential for self-maintenance. Aggregated economic goods and services (GWP) can be invested in maintaining or creating any of the four capitals, or can be consumed. Investment in human, social or built capital requires a fixed amount of GWP and of raw materials, though it is possible to allow raw material demands to change with changing technology. Rates of investment in each type of capital are control variables in the model. Consumption depreciates instantly into waste, and social, human and built capital become waste as they depreciate over time. Waste absorption capacity is an ecosystem service, and if the flow of waste is greater than the absorption capacity, waste accumulates. Waste accumulation (i.e., pollution) directly affects the ability of natural capital to spontaneously reproduce, and can even cause it to spontaneously degrade. It also decreases production of GWP and SSW.

2.10 Ecosystem Services

The 17 ecosystem services listed in Costanza et al. (1997a) have been aggregated somewhat in GUMBO and some were not included. Seven classes of ecosystem services are included in GUMBO (Figure 7) and are briefly described below. A more complete classification and description of ecosystem services and functions is available in de Groot

et al. (this volume). In what follows we briefly describe how each class of service is included in GUMBO

2.10.1 Gas regulation

Gas regulation refers to the regulation of atmospheric chemical composition (Costanza et al. 1997a). In GUMBO, this ecosystem service is primarily associated with the changes in the global C cycle-- exchanges of carbon within the biosphere and primary productivity of the biosphere terrestrial and ocean biomes. The exchange of C is simulated as processes such as terrestrial respiration, fossil fuel extraction, degassing, oceanic exchanges and consumption of organic matter. Together, these promote carbon inflow or outflow within the atmospheric C pool.

2.10.2 Climate regulation

This service is defined as the regulation of global temperature, precipitation, and other biologically mediated climatic processes at global or local levels (Costanza et al. 1997a). In GUMBO, climate regulation is associated with variations in global temperature from year to year. A global biome energy pool determines global average temperature. An inflow of solar radiation to the Earth and an outflow of radiation from the Earth to space controls this energy pool, and the energy pool is in turn affected by the extent of biome area, their albedo capacity and by the atmospheric C pool.

2.10.3 Disturbance regulation

This service is described as an ecosystem's capacitance, damping and resilience in response to environmental fluctuations (Costanza et al. 1997a). In the GUMBO model, it is measured as the biome's yearly change of total biomass (autotrophs, consumers and

decomposers). The lower the variability in biomass, the greater the systems' disturbance regulation service.

2.10.4 Soil Formation

Soil formation results from the weathering of rock material and of the accumulation of organic matter (de Groot et al. 2002). In GUMBO, the process of soil formation is closely related to rates of decomposition (Schlesinger 1997), thereby accounting for different rates of organic matter accumulation in different biomes. As autotrophs and consumers die, a pool of dead organic matter accumulates, and from this pool a flux of soil formation is generated in each biome.

2.10.5 Nutrient cycling

This service refers to the storage, cycling, processing and acquisition of nutrients within the global system (Costanza et al. 1997a). In GUMBO, Nitrogen is used as a proxy for all other nutrients, and plant uptake of N serves as a proxy for nutrient cycling. Plant N uptake is represented as an inflow of nutrients into the soil nutrient pool associated with each biome's gross primary production, soil formation and biomass nutrient content. The soil nutrient pool also is influenced by atmospheric exchanges, weathering of rock material and fertilizer application.

2.10.6 Waste assimilation

This service refers to nature's ability to recover mobile nutrients, and remove or breakdown excess xenic nutrients and compounds (Costanza et al. 1997a). In GUMBO, this is modeled as the product of waste stock and either waste assimilation rate or waste

assimilation potential - the model chooses the lowest value from the two. In each time step assimilation potential is represented as total assimilation capacity relative to the current amount of waste.

2.10.7 Recreational and cultural

These services hinge on an ecosystems' ability to provide for recreational activities such as eco-tourism and sport fishing as well as cultural activities like worship and aesthetic appreciation (Costanza et al. 1997a). In the GUMBO model, recreational and cultural activities are positively related to total biomass amounts and the density of the social network, and negatively related to human population stocks. Hence, while the recreational and cultural activities service increases with increasing social network density and biomass, it decreases with increasing population.

2.11 "Prices" of ecosystem services: marginal products as a measure of value

While future versions of the GUMBO model will include a variety of methodologies for calculating ecosystem values², the current version calculates the marginal product of ecosystem services in both the model's production and welfare functions. The rationale is simple. We calculate the impact of an incremental change in an ecosystem service on total output (either production of goods and services or of welfare). For example, if an

² For example, the "simplest" approach to pricing ecosystem services in the model is to estimate prices externally and assume that they are constant over a model run. We can use the methods described in Costanza et al (1997a), updated with new data and with user controlled ranges on each of the prices. This allows users to see the implications of various constant ecosystem service prices on the value (price times quantity) of these services over time. A second method of pricing ecosystem services is based on ecological production input output matrices as described in Patterson (this volume). At each time step in a run of the GUMBO model we export a production flow matrix and calculate the ecological production based prices. The time series of these prices can then be compared with constant prices and with various policy scenarios in the model. Methods based on intertemporal optimization and shadow prices are discussed in the paper's conclusion.

additional unit of ‘climate stability’ (measured as reduced variability around a mean temperature) increases global output by \$3 million, then climate stability must be worth \$3 million per unit at the margin under current conditions. We will refer to these estimates of marginal product as ecosystem service prices. Conditions for calculating ‘theoretically correct’ prices using this approach include optimal allocation of all resources, no externalities, and no public goods. However, we are not interested in theoretical prices in some fictitious ‘optimal’ world, but rather in what the world would be willing to pay for an extra unit of that service under actual conditions in the current time period, given the existing allocation of other resources—and this is precisely what the marginal contribution of an ecosystem service to global production or social welfare tells us. In addition, GUMBO is a global model in which externalities and property rights (and hence the public good issue) are irrelevant with respect to prices. Further, within the model, we know resource stocks and deterministic model equations are equivalent to complete knowledge concerning system-wide impacts of resource use. Hence, while the assumptions necessary for the marginal analysis approach to pricing rarely hold in the real world, they do approximately hold in the world of the GUMBO model (which is one of the main reasons for constructing the model in the first place).

Another important point is that the appropriate price for ecosystem services is the current time marginal product of the service, not including the value of the given service in future time periods. We make an important distinction between environmental goods that are produced from ecosystem structure and ecosystem services that result from ecosystem function. Without ecosystem structure there is, of course, no ecosystem function, but the two components of natural capital have quite different physical and

economic properties and must be treated separately. Ecosystem goods are in the form of stocks and flows: a stock of trees generates a flow of wood products, a stock of fish generates a flow of fish protein, and a stock of grass generates a flow of fodder. These goods are in general both rival and excludable, and in the absence of negative externalities from their use, could be suitably allocated by market forces. Ecosystem services are in the form of funds and services: a fund of forest generates the services of climate regulation, gas regulation and water regulation. Services cannot accumulate into stocks, so in calculating the price for a service, it would be a mistake to consider costs or benefits derived from that service in future periods. Note also that most ecosystem services are both non-rival and non-excludable (waste absorption capacity is an important exception, as it is rival, and can be made excludable), and hence cannot be efficiently allocated by unregulated market forces.

There are at least two specific ways of using the GUMBO model to calculate the marginal productivity of ecosystem services. The obvious approach is to take total first derivatives of the GWP and the SSW production functions with respect to the ecosystem service in question, which is the equivalent to the marginal product of the service. However, this constrains us to using continuously differentiable functions to model ecosystem processes, which may not be the best representation of reality. Instead, we prefer that state-of-the-art understanding of ecosystem processes, and not a specific methodology, drive the model. As an alternative, we can ‘empirically’ estimate the marginal product of each ecosystem service. We simply take the model output for each time step, freeze all variables but the one we wish to price, and change this one by a small

increment.¹ The measured change in the value of the output will be equal to the price of the increment of the variable in question. With the latter approach, we are free to use the most appropriate function to model a particular process. In the current version of the model, we have taken the simpler approach of mathematically approximating first derivatives.

2.12 Land use

Eleven land (and water) use/cover types (or biomes) are included in GUMBO (Open Ocean, Coastal Ocean, Forests, Grasslands, Wetlands, Lakes/Rivers, Deserts, Tundra, Ice/rock, Croplands, and Urban). Land use changes in GUMBO (Figure 8) are driven by human population and GWP changes (from the anthroposphere), constrained by the remaining area of each biome. Population is partitioned into urban and rural components.

2.13. Data Base

A separate sector is included in GUMBO to store the calibration data for the model, convert units as necessary, and do other miscellaneous conversions (Figure 9). Global data includes: average temperature, atmospheric CO₂ concentration, anthropogenic CO₂ production, average sea level, GWP, human population, oil production, fish harvest, food production, forest products, metals and minerals production, and land use for each of the 11 biomes. Our plan is to ultimately link the model to an integrated on-line data base that we are creating (see Villa et al. this volume) which will allow continuing recalibration and testing of the model.

¹ To do this efficiently, we would feed the output of the GUMBO model into another program designed specifically to carry out these calculations.

Data Base

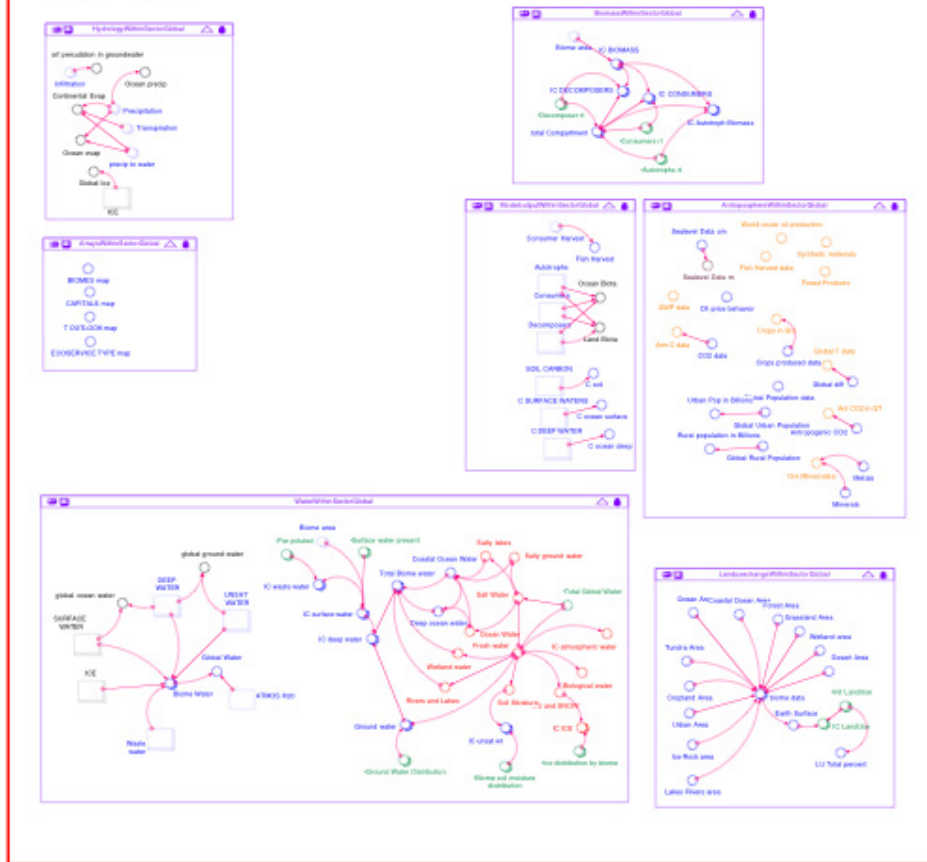

Fig. 9. STELLA diagram of the Data Base sector

2.13 Limitations and caveats

Like any model, GUMBO only represents a simplified description of the world and has the same general limitations shared by all global models. Because “simplification is the essence of model building”, there will always be issues that remain outside the purview of the model (Meadows and Meadows 1975, p. 17). For example, we remain largely ignorant of precisely how ecosystem structure generates ecosystem services, and must instead rely on the best accepted and most plausible explanations present in the literature to model these complex relationships (see de Groot et. al., this volume). Some of the changes important to GUMBO are characterized by pure uncertainty - we are ignorant not only of the probabilities of various outcomes, but we do not even know what outcomes are possible. This is particularly true for ecosystem evolution and for the invention of new human technologies, both of which are critical factors determining the impact of human action on ecosystem services. As we describe later, these uncertainties are handled using alternative future scenarios that allow the implications of alternative assumptions to be explored. Another serious challenge involves investments in productive capacity within the economic sub-system. Most global models have greatly simplified economic production within the model by either leaving out price-investment feedback loops (Meadows et al. 1972; Meadows et al. 1992), or by treating economic production as exogenous to the system (Rotmans and de Vries 1997). In GUMBO, relative rates of investment are currently treated as exogenous control variables manipulated by the model user. In addition, the functional forms we have chosen for both the GWP and SSW functions (see Anthroposphere) are relatively simplistic and the variable coefficients are somewhat subjective. However, a major strength of the

GUMBO model is that users can readily manipulate these functions and variables and observe the resulting impacts on the model output.

3 Results

In this section, we describe both the preliminary calibration results for the model and the results of a series of scenarios. These results are summarized in Figures 10-15. The model was run starting in 1900 for 200 years at a time step of 1 year. Each figure shows a selection of related variables over the historical period from 1900 to 2000, and continuing over the future period from 2000 to 2100. Time series of available calibration data are plotted on the appropriate figures for direct visual comparison with the model results. One can see from inspection of these figures that the model has been calibrated to agree quite well with the full range of available historical data, including land use, global temperature, atmospheric CO₂, sea level, fossil fuel extraction, human population, and GWP. It should be noted that these results are not “forced” in any way by exogenous variables, but are the results of the internal dynamics of the model. Because it is an integrated global model, all the variables are endogenous except solar energy inputs, which are assumed in this version to be constant over time.

Table 2 shows the results of some statistical tests of the fit between the model and the data. We had data on a total of 14 variables. For each variable, Table 2 shows the results of a linear regression with the GUMBO model as the independent variable and data as the dependent variable. Table 2 shows the R², F value for the regression equation, degree of freedom (model, data), intercept (\pm Standard Deviation) and slope (\pm Standard Deviation). The R² values for all 14 variables are very high, ranging from .64

for global temperature to .98 for human population, GWP, and forest area. The average R^2 over the 14 variables was .922. All F values for the regressions were highly significant ($p < .0001$), indicating that the model explained a significant amount of the variation in the data. But the regression equations do not check that the relative magnitudes of the model and data match. In terms of the regression equations, the slope should be equal to 1 and the intercept equal to 0. We used the method suggested by Dent and Blackie (DBK, 1979) to test the joint hypothesis that the regression's slope is statistically indistinguishable from one and the intercept is statistically indistinguishable from zero. Table 2 reports the F values, respective significance levels (***) indicates $p < .0001$) and associated degrees of freedom (model, data). Eight of the 14 variables passed this rather severe test of the model's fit with the data, and one can see from inspection of Table 2 that the other 6 variables have slopes and intercepts that, while not statistically indistinguishable from one and zero, are still rather close.

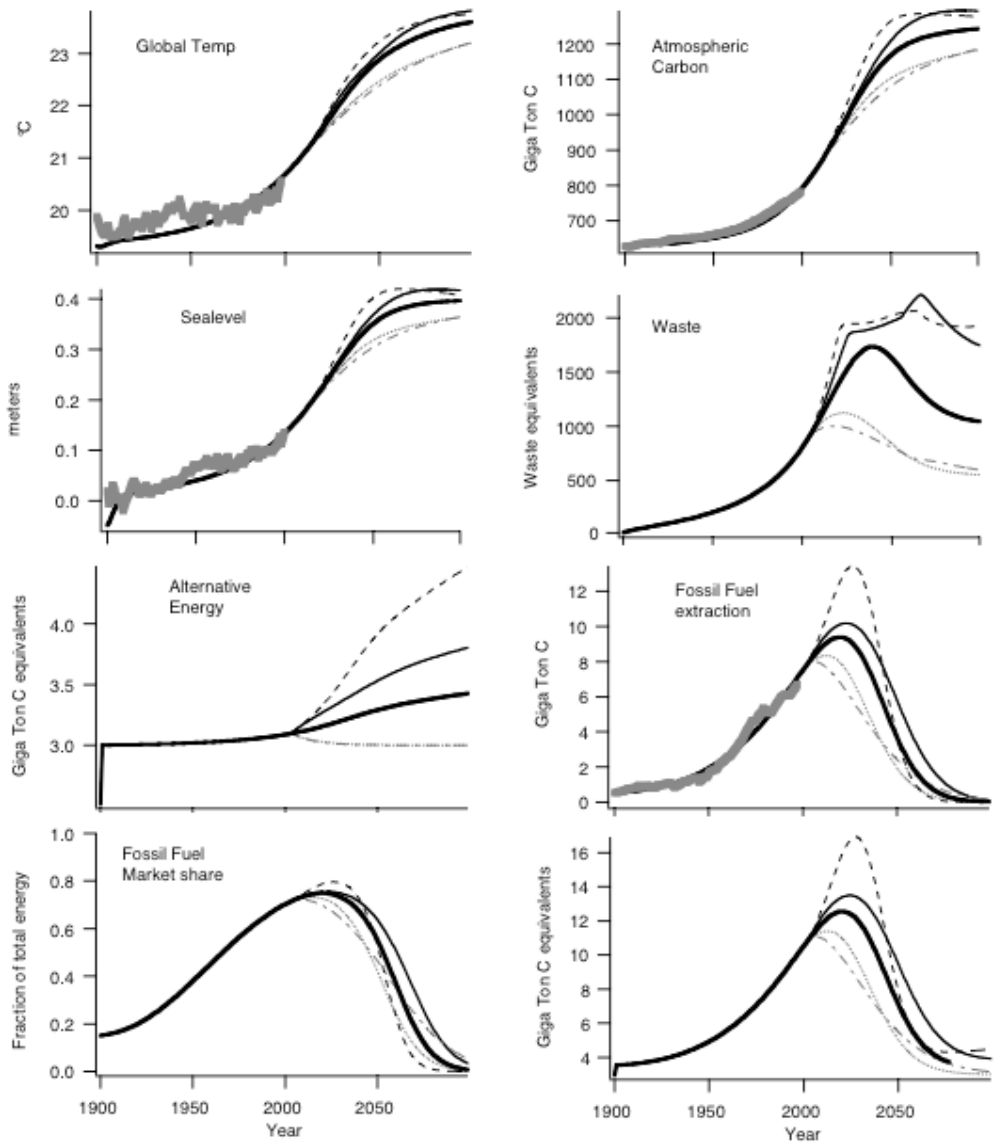

Fig. 10. Selected biophysical variables in GUMBO. All plots show the base case calibration and observations (if available) from 1900 to 2000, and the five scenarios listed in the legend for 2000 to 2100.

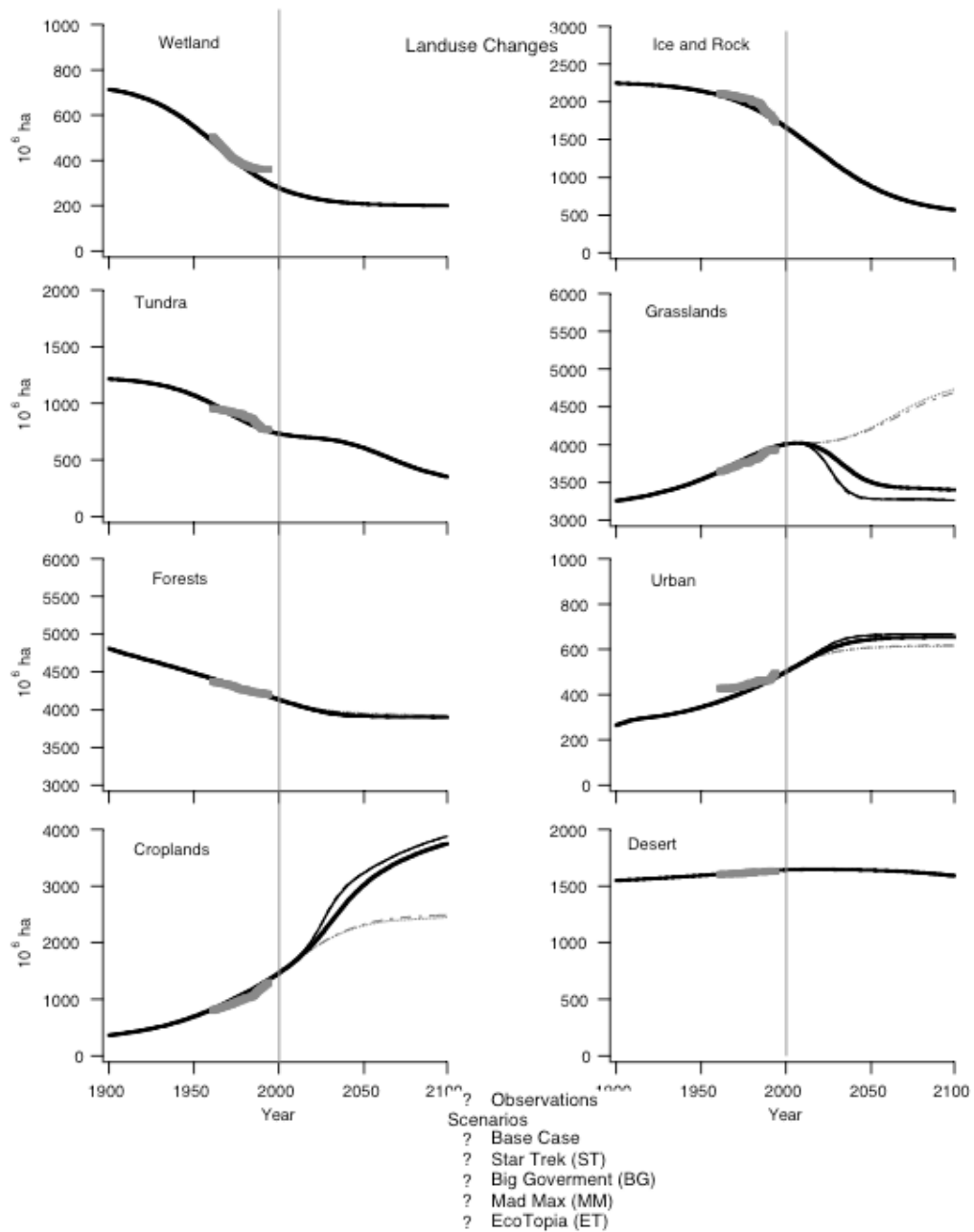

Figure 11. Selected land use variables in GUMBO. All plots show the base case calibration and observations (if available) from 1900 to 2000, and the five scenarios listed in the legend for 2000 to 2100.

Fig. 11. Selected land use variables in GUMBO. All plots show the base case calibration and observations (if available) from 1900 to 2000, and the five scenarios listed in the legend for 2000 to 2100.

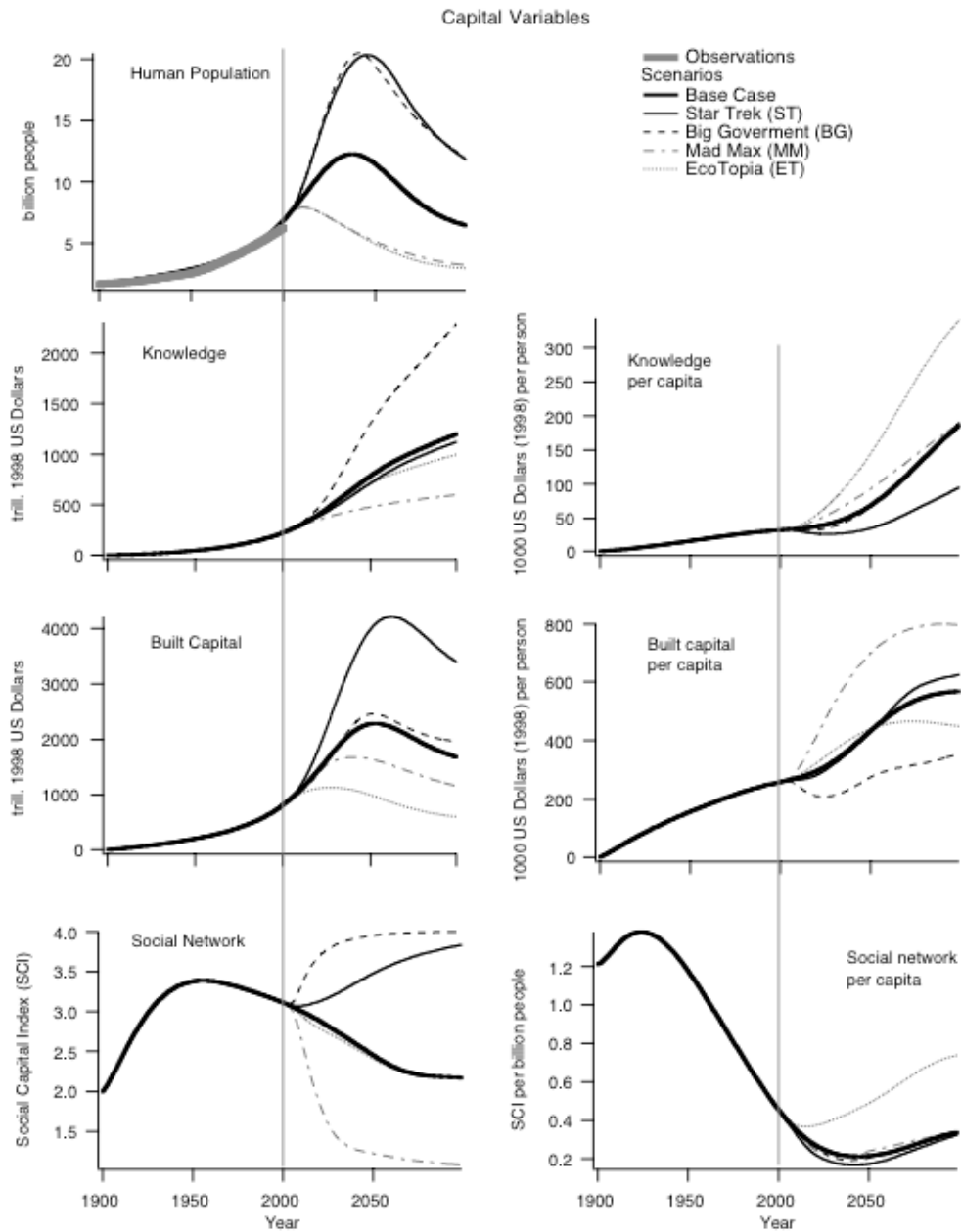

Figure 12. Selected capital variables in GUMBO. All plots show the base case calibration and observations (if available) from 1900 to 2000, and the five scenarios listed in the legend for 2000 to 2100

Fig. 12. Selected capital variables in GUMBO. All plots show the base case calibration and observations (if available) from 1900 to 2000, and the five scenarios listed in the legend for 2000 to 2100.

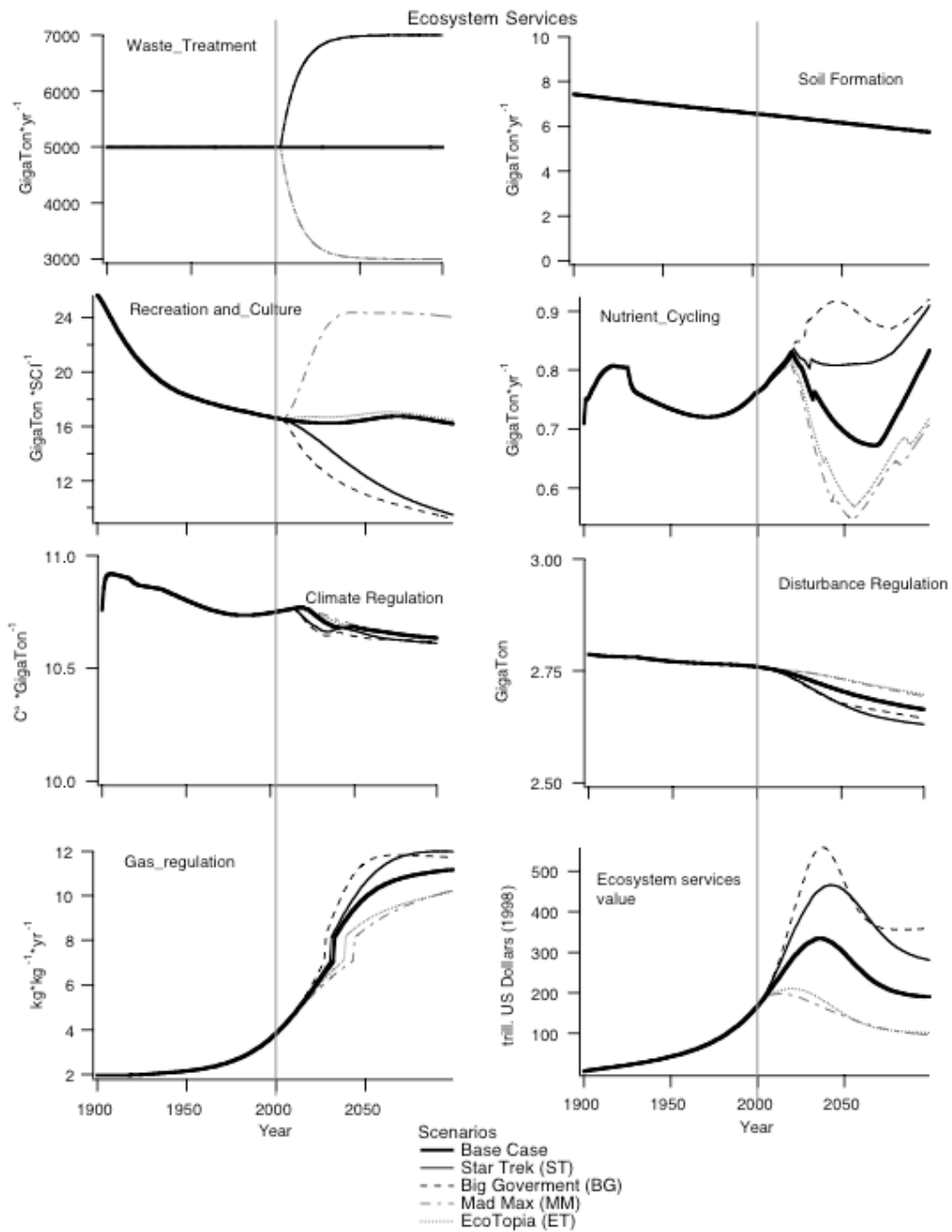

Figure 13. Selected ecosystem services variables in GUMBO. All plots show the base case from 1900 to 2000, and the five scenarios listed in the legend for 2000 to 2100. All plots are physical measures except ecosystem services value, which is the sum of the physical measures multiplied by prices in Figure 14.

Fig. 13. Selected ecosystem services variables in GUMBO. All plots show the base case from 1900 to 2000, and the five scenarios listed in the legend for 2000 to 2100. All plots are physical measures except ecosystem services value, which is the sum of the physical measures multiplied by prices in Figure 14.

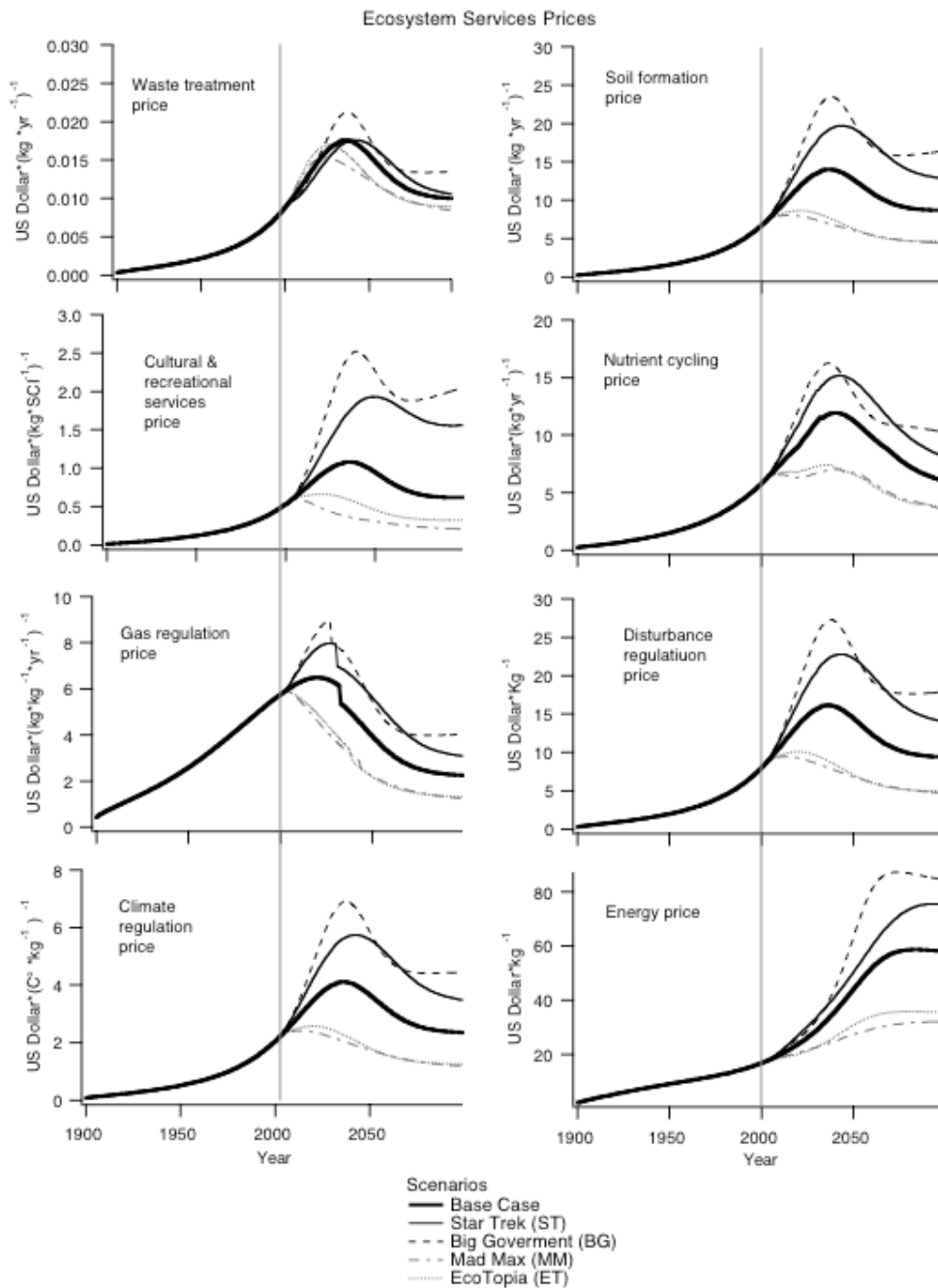

Figure 14. Ecosystem services prices in GUMBO. All plots show the base case from 1900 to 2000, and the five scenarios listed in the legend for 2000 to 2100

Fig. 14. Ecosystem services prices in GUMBO. All plots show the base case from 1900 to 2000, and the five scenarios listed in the legend for 2000 to 2100.

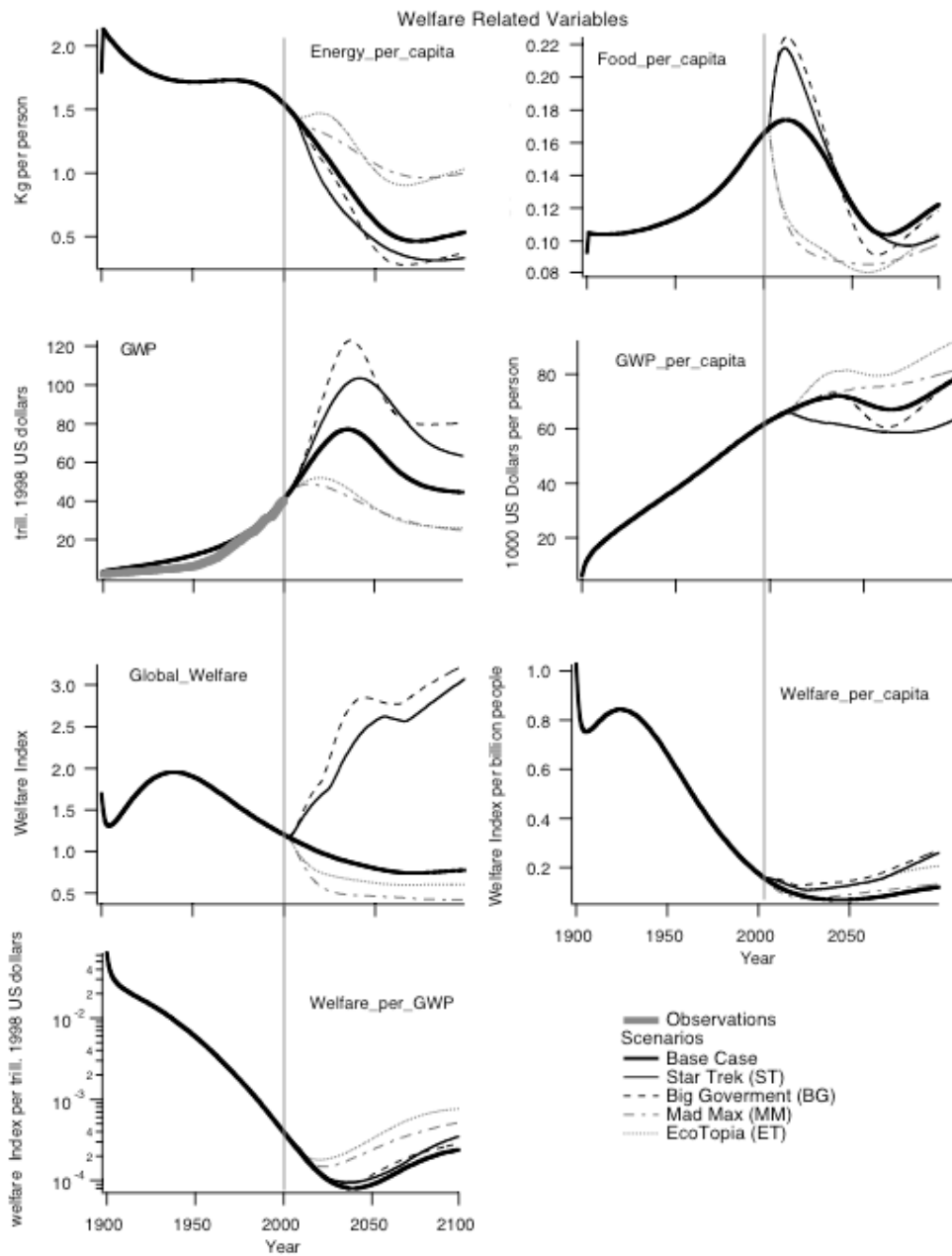

Figure 15.

Fig. 15. Selected welfare related variables in GUMBO. All plots show the base case calibration and observations (if available) from 1900 to 2000, and the five scenarios listed in the legend for 2000 to 2100.

Overall, we can conclude that the model fits the (limited) available quantitative time series data extremely well. But what about the variables for which we do not have quantitative time series data? We used more qualitative assessments of these variables, insuring that they at least behaved consistent with any quantitative data we had along with our best guesses of the real behavior. Also, since GUMBO is a systems model, rather than a statistical model, all the variables are interdependent. Calibrations for any variable affect all the other variables, and this imposes an overall consistency check on the model.

As far as model validation is concerned, we plan to assemble additional time series data for variables in the model other than the 14 reported in Table 2. We can then test the fit of the model to these variables before any additional calibration is performed as a validity check.

Table 3. Parameters reflecting assumptions about how the world works and investment policies for the baseline (neutral) and four alternative scenarios. Each alternative scenario represents a combination of either optimistic or skeptical assumptions about how the world works, with either optimistic or skeptical patterns of investment in the four types of capital. For example, the “Big Government” scenario combines optimistic state of the world assumptions with skeptical investment policies, while “Star Trek” combines optimistic state of the world assumptions with optimistic investment policies.

State of the World Assumptions:	Neutral	Optimistic	Skeptical	Skeptical	Optimistic	Description
Parameter name	Baseline	Big Government	Eco-Topia	Mad Max	Star Trek	
<i>Ecosystem health and Human population</i>						Effect of developments in medical science on mortality.
•Health care factor	0.002	0.003	0.001	0.001	0.003	Maximum that can be achieved in reduction of mortality.
•Max healthcare effect	0.01	0.003	-0.01	-0.01	0.03	Threshold amount of waste that will be fatal to all human beings.
•Waste carrying capacity	80000	100000	60000	60000	100000	Effect that knowledge has on the human fertility rate.
•knowledge v fertility	0.001	0.002	0	0	0.002	Maximum effect of knowledge on the fertility rate.
•Fertility Know max	0.03	0.04	0.02	0.02	0.04	Amount of waste that will surpass the earth’s waste assimilation capacity.
<i>Waste treatment Params</i>						Effect of natural capital formation on waste assimilation effectiveness.
•Assimilation capacity	5000	7000	3000	3000	7000	
•effect of NCF on waste	0.5	0.1	0.9	0.9	0.1	Time when new energy sources will start to come on line
<i>Unknowns about our energy reserves</i>						Ultimately recoverable fossil fuel
•Time Switch	2100	2003	2003	2003	2003	Maximum of new (currently unknown) energy available
•Accessible oil	700	800	600	600	800	Rate of change to new alternative energy source
•Max unknown alt Energy	2	4	0	0	4	
•Energy switch Rate	0.1	0.1	0.1	0.1	0.1	Effect of new knowledge on social capital
<i>Did Technology cause a decline in social Capital</i>						
•Knowledge SC effect	0.0002	0	0.0004	0.0004	0	
<i>Developments in meat and fish production</i>						Maximum percentage of fish that can be harvested from the ocean.
Ocean						Effect of energy on the efficiency with which fish can be harvested from the ocean
•Max Energy effect on Con Harvest	0.04	0.06	0.02	0.02	0.06	
•Energy effect on Con Harvest	0.003	0.006	0	0	0.006	Maximum percentage of fish that can be harvested from the coastal ocean
Coastal Ocean						

Table 3 (continued)

•Max Energy effect on Con Harvest	0.04	0.06	0.02	0.02	0.06	
State of the World Assumptions:	Neutral	Optimistic	Skeptical	Skeptical	Optimistic	Description
Parameter name	Baseline	Big Government	Eco-Topia	Mad Max	Star Trek	
•Energy effect on Con Harvest	0.003	0.006	0	0	0.006	Effect of energy on the efficiency that fish can be harvested from the coastal ocean
Grasslands						
•Max Energy effect on Con Harvest	0.02	0.025	0.015	0.015	0.025	Maximum percentage of animals can be harvested from the grasslands.
•Energy effect on Con Harvest	0.04	0.07	0.01	0.01	0.07	Effect of energy on the efficiency that animals can be harvested from the grasslands
<i>Agricultural Developments in croplands</i>						
•Energy effect on plant Harvest[Cr]	0.25	0.3	0.2			Effect of energy on the efficiency with which crops can be harvested.
•Max Energy effect on plant harvest[Cr]	0.7	0.9	0.5			Maximum potential percentage of crops that can be harvested
•effect of Knowhow on Chlo conc[Cr]	0.03	0.04	0.02			Ability of the agricultural sciences to increase crop production per acre.
•Max Know on Chl effect[Cr]	0.02	0.03	0.01			Maximum achievable crop production per unit area.
Policies	Neutral	Skeptical	Skeptical	Optimistic	Optimistic	
Parameter name	Baseline	Big Government	EcoTopia	Mad Max	Star Trek	
<i>Savings Rates</i>						
Human Capital	0.016	0.022	0.022	0.01	0.01	
Social Capital	0.16	0.18	0.46	0.05	0.02	Social capital savings rate is dependent on human population densities
Built Capital	0.15	0.1	0.1	0.2	0.2	
Natural Capital	0.15	0.3	0.3	0	0	
Consumption	0.52	0.40	0.12	0.74	0.77	

Table 2. Results of regression and Dent and Blackie (DBK) tests for the 14 model variables for which historical data was available.

Fitted Variable	R ²	Regression				DBK test	
		F (regression)	DOF	Intercept±SD	Slope±SD	F (DBK)	DOF
1. Forest area	0.98	2061.2	1,33	-988±116	1.2±0.03	1.851	2,32
2. Grassland area	0.97	1035.1	1,33	-216±125	1.1±0.03	0.984	2,32
3. Wetland area	0.93	437.7	1,33	-92±23	1.2±0.06	0.978	2,32
4. Desert area	0.95	6022.1	1,33	-148±72	1.1±0.04	26.239***	2,32
5. Tundra area	0.88	236.7	1,33	-106±63	1.1±0.07	0.036	2,32
6. Ice Rock area	0.92	365.1	1,33	182±92	0.9±0.05	0.051	2,32
7. Cropland area	0.97	1085.0	1,33	8.8±33	1.1±0.03	0.230	2,32
8. Urban area	0.92	413.1	1,33	-297±35	1.6±0.08	19.251***	2,32
9. Atmospheric Carbon	0.98	6873.0	1,99	5±8	1.0±0.01	5.583***	2,98
10. Fossil fuel prod.	0.98	4319.9	1,97	0.045±0.048	1.0±0.01	105401.000***	2,96
11. Global temperature	0.64	179.7	1,98	-5.3±1.9	1.2±0.09	8092.000***	2,97
12. Sea level	0.83	488.7	1,100	-0.01±0.003	1.0±0.04	151686.000***	2,99
13. Human population	0.98	126597.6	1,100	0.14±0.03	1.0±0.01	7827.550***	2,99
14. Gross World Product	0.98	5459.2	1,100	4.09±0.20	0.9±0.01	109.041***	2,99

For each variable, the regression results are reported first: R², F value for the regression, degrees of freedom (model, data), intercept, and slope (± Standard Deviation). All F values for the regressions were highly significant. For the DBK test, the F value (***) indicates highly significant), followed by the degrees of freedom (model, data) are given. See text for more details.

3.1. Scenarios

A series of five scenarios are also plotted on Figures 10-15. These scenarios include a base case (using the “best fit” values of the model parameters over the historical period) and four alternative scenarios. These four alternatives are the result of two variations (an optimistic and a skeptical set) concerning assumptions about key parameters in the model, arrayed against two variations (an optimistic and a skeptical set) of policy settings concerning the rates of investment in the four types of capital (natural, social, human, and built). They correspond to the four scenarios laid out in Costanza (2000). These assumptions and policies are laid out in Table 3. If one pursues a set of optimistic policies (higher rates of consumption and investment in built capital, lower investment in human, social and natural capital) and the real state of the world corresponds to the optimistic parameter assumption set (new alternative energy comes on line, etc.) then one ends up in the “Star Trek” (ST) scenario. If one pursues optimistic policies and the real state of the world corresponds to the skeptical parameter assumption set (no new energy comes on line, etc.) then one ends up in the “Mad Max” (MM) scenario. If one pursues a set of skeptical policies (lower rates of consumption and investment in built capital, higher rates of investment in human, social and natural capital) and the real state of the world corresponds to the optimistic parameter assumption set then one ends up in the “Big Government” (BG) scenario. Finally, if one pursues skeptical policies and the real state of the world corresponds to the skeptical parameter assumption set then one ends up in the “EcoTopia” (ET) scenario.

In the model, the new parameter sets are brought on line gradually (at a user determined rate) starting at a user determined date. For this set of scenario runs, the start date was 2003 and the rate of introduction was 10% per year.

The GUMBO model contains 234 state variables, 930 variables total, and 1715 parameters. Figures 10-15 show a small subset of some of the more interesting and relevant output. Figure 10 shows some of the key biophysical variables, including average global temperature, atmospheric carbon, sea level, and fossil fuel extraction. All of these reproduce historical behavior extremely well. The base case projection for global temperature in 2100 is about 3.5° C above the current temperature, consistent with the latest IPCC projections. In general, the ST and BG scenarios lead to higher global temperatures, CO₂, sea level, waste, and fossil fuel extraction than the base case, while ET and MM are generally lower than the base case in these same variables. The alternative energy plot is a key one. Alternative energy includes all alternatives to fossil fuel, including renewable energy sources such as solar, wind, and biomass, but also any as yet undiscovered or unperfected energy sources such as nuclear fusion (hot or cold) or very advanced solar collectors. The ST and BG scenarios assume that alternative energy is a huge new resource that comes on line fairly quickly after 2003, while the ET and BG scenarios assume that alternative energy is limited to the currently known renewable alternatives and that their supply is ultimately somewhat limited. Total energy is the sum of fossil and alternative energy. The BG scenario assumes higher rates of investment in knowledge creation (i.e. through research and development) and thus leads to higher alternative and total energy than the ST scenario.

Figure 11 shows land use for 8 of the 11 biomes (lakes/rivers, open ocean, and coastal ocean areas do not change significantly). Data sets are from FAO for the period from 1961 to 1994. The model calibrates quite well to historical land use changes at the global level, with only grasslands, croplands, and urban showing significant differences between the five scenarios. Grasslands are highest in MM and ET because they are converted to croplands at a much lower rate. Croplands are correspondingly higher in BG and ST and lower in ET and MM than the base case. Urban is slightly higher than the base case in BG and ST, and slightly lower in ET and MM.

Figure 12 shows types of human-made capital, including human population and knowledge (together forming human capital), built capital, and social capital (as measured by the strength of social networks). The human population is significantly higher in both ST and BG, peaking at about 20 billion. Population declines in all scenarios are a result of decreasing human fertility which is linked to increased knowledge, not to increasing mortality (Lutz et al. 2001). ST and MM peak at about 7 billion, while the base case peaks at about 12 billion. Knowledge is highest in BG (due to increased investment in government supported R&D) and lowest in MM. But knowledge per capita is highest in ET and lowest in ST, due to the relative rates of change in population and knowledge in these scenarios. Built capital is highest in ST and lowest in ET, but built capital per capita is highest in MM, intermediate in ET, and lowest in BG. Social capital is highest in BG and lowest in MM, with ET not very different than the base case. But social capital per capita is significantly higher in ET than in the other scenarios due to increased investment in social capital and lower population.

Figure 13 shows the seven ecosystem services included in the model in physical units, and the total value of all ecosystem services (prices times quantities). The value of global ecosystem services based on this approach, are shown to be about 180 Trillion \$US in the year 2000. This compares to a GWP of about 40 Trillion \$US in the year 2000 (Figure 15), indicating that ecosystem services are about 4.5 times as valuable as GWP in the model in the year 2000. This compares to a factor of about 1.8 estimated using static, partial, analysis in Costanza et. al. (1997a). In all of the future scenarios, the value of ecosystem services and GWP roughly parallel each other. Ecosystem services are estimated to be most valuable in ST and BG, due to larger populations and greater relative scarcity, as is evident from the increased prices of the services (as measured by their marginal products), which are shown in Figure 14.

Figure 15 shows welfare-related variables. GWP is highest for ST and BG and lowest for ET and MM. But GWP per capita is highest for ET and lowest for ST. The situation for total welfare and welfare per capita is similar, but in these cases MM is significantly lower than the other scenarios in both total welfare and welfare per capita. An interesting measure of economic efficiency we have calculated in the model is welfare per GWP, based on the idea that a really efficient economy would produce the maximum amount of welfare for the minimum GWP, rather than simple maximizing GWP. According to this measure, ET performs much better than any of the other scenarios or the base case.

4. Discussion and Conclusions

As stated earlier, our main objective in creating the GUMBO model was not to accurately predict the future, but to provide simulation capabilities and a knowledge base

to facilitate integrated participation in modeling. We created a computational and data base framework to aid in the discussion and design of a sustainable future that includes the dynamics of human well-being. It should be noted that this is “version 1.0” of the model. It will undergo substantial changes and improvements as we continue to develop it, and the conclusions offered here can only be thought of as “preliminary.”

Nevertheless, we can reach some important conclusions from the work so far, including:

- To our knowledge, no other global models have yet achieved the level of dynamic integration between the biophysical earth system and the human socioeconomic system incorporated in GUMBO. This is an important first step.
- Preliminary calibration results across a broad range of variables show very good agreement with historical data. This builds confidence in the model and also constrains future scenarios. We produced a range of scenarios that represent what we thought were reasonable rates of change of key parameters and investment policies, and these bracketed a range of future possibilities that can serve as a basis for further discussions, assessments, and improvements. Users are free to change these parameters further and observe the results.
- Assessing global sustainability can only be done using a dynamic integrated model of the type we have created in GUMBO. But one is still left with decisions about *what* to sustain (i.e. GWP, welfare, welfare per capita, etc.) GUMBO allows these decisions to be made explicitly and in the context of the complex world system. It allows both desirable and sustainable futures to be examined.

- Ecosystem services are highly integrated into the model, both in terms of the biophysical functioning of the earth system and in the provision of human welfare. Both their physical and value dynamics are shown to be quite complex.
- The overall value of ecosystem services, in terms of their relative contribution to both the production and welfare functions, is shown to be significantly higher than GWP (4.5 times in this preliminary version of the model).
- “Skeptical” investment policies are shown to have the best chance (given uncertainty about key parameters) of achieving high and sustainable welfare per capita. This means increased relative rates of investment in knowledge, social capital, and natural capital, and reduced investment in built capital and consumption.

5. Future Work

In future iterations, we will use GUMBO to calculate the “shadow prices” of ecological resources based on “optimal” (rather than “actual”) levels of resource use. Shadow prices account for the future goods and services generated by an additional increment of capital today. In contrast to ecosystem services, which cannot accumulate over time, the value of a natural capital stock is determined by the value of the flows of ecosystem goods and services it generates through time. The same is obviously true for the other forms of capital: for example, the value of a factory is equal to the value of the widgets it will produce through time, discounted by the opportunity cost of financial capital. Natural capital generates both market and non-market goods, but in the GUMBO model these contribute to human welfare just as concretely as widgets, albeit through more numerous paths. Renewable natural capital is unique in that its capacity to

regenerate is determined in part by the current stock, so the marginal value of the stock must also account for the additional stock that will regenerate from the additional incremental unit. In the GUMBO model and in reality, if renewable natural capital stocks fall below a certain level, they risk hitting an ecological threshold of spontaneous decline. Ideally, the value of an incremental unit of forest stock should include the reduced risk of reaching this threshold (see Limburg et al., this volume). In the real world, of course, we do not know where such thresholds lie.

The basic problem in this case is to maximize the equation

$$ISW = \int_0^{\infty} SSW(HK(t), SK(t), BK(t), NK(t)) e^{-\delta t} dt$$

where ISW is intergenerational sustainable welfare, ($SSW(\circ)$ is the sustainable social welfare function from the GUMBO model, and δ is the discount rate, which will be discussed in greater detail below. An analogous equation applies to the production of goods and services. In both cases, of course, the maximization must be done subject to the laws of motion for all arguments of $SSW(\circ)$. The solution to this problem provides us with the time path for optimal resource use, from which it would be quite simple to calculate marginal productivity of ecological resources and hence values.

The enormous number of variables in the GUMBO model (and in the real world) make it impractical, if not impossible, to use analytical techniques to solve for an optimum. In addition, with so many variables it is virtually certain that there are many local optima for the model, and seeking a global optimum would probably be both futile and pointless. We are in the process of developing programs that will be able to find a number of optima in the GUMBO model for very long time horizons, and calculate shadow prices for each of these optima. Obviously, different local optima are likely to

produce different prices and values for ecological resources, so we will present prices as a range, not as an exact number.

Dynamic optimization problems with infinite time horizons are notoriously sensitive to the choice of a discount rate, yet there is little consensus on a ‘correct’ rate, or even whether discounting is appropriate for intergenerational analysis. For example, in analyses of global warming, Cline (1992) argues for a rate in the region of 1.5%, while a study by Nordhaus (1994) uses 6%¹⁴. Solow admits that discount rates may not be appropriate for intergenerational issues (Solow, 1974). Indeed, , a commonly heard justification for positive discount rates is that they are a ‘mathematical necessity’ (e.g. Arrow et. al. 2000, p. 1402; citing Koopmans). This is a case of the methodology determining the problem instead of vice versa.

The typical justification for intertemporal discounting is the marginal opportunity cost of capital. While this certainly makes sense at the scale of a businessman considering a 20-year investment, scaling issues arise when extrapolating this rationale to a global, infinite time horizon model. For a small-scale investment the relevant discount rate is the marginal opportunity cost of capital. Presumably, however, the opportunity cost of money changes depending on the level of investment. In the GUMBO model, we are looking at all investments. Therefore, we are concerned with the average opportunity cost of capital, not simply the marginal opportunity cost. Further, we are examining all capital types and not just financial capital. Thus, the relevant discount rate for a given year relative to the previous year should be the average opportunity cost of total capital, which is essentially the rate of growth of the entire system.

¹⁴ Though in the Nordhaus model the rate drops to 3% in the future.

It certainly makes sense that growth rates form the basis for intertemporal discounting. Financial capital only provides returns because it can be invested to generate more production in the future. Financial capital has no value itself, but simply entitles someone to a share of the real wealth. If financial capital received positive returns but there was no growth in production of goods and services, then there would simply be more money chasing the same amount of goods (i.e. inflation) or else there would have to a redistribution of real wealth towards the holders of financial capital. In fact, a richer future combined with the diminishing marginal value of wealth is another frequent justification for discounting.

What happens then when we look at an infinite time horizon? The appropriate discount rate over time is the average rate of growth of total capital over time. The GUMBO model is based on a finite planet, in which infinite material growth is impossible. Eventually, therefore, we must either approach some sort of steady state, in which the growth rate becomes zero, or else experience negative growth. Unless we experience negative growth rates in the future, the average rate of growth will only asymptotically approach zero as time approaches infinity. If we allow δ to change through time and set it equal to the average growth rate of the system, as long as a future generation is better off than the present one, values in that generation will be appropriately discounted. If the growth in the future becomes negative for long enough that the future is worse off than the present, then this approach would allow future generations to receive a greater weight than the present one.

This is a radical departure from traditional approaches to discounting, and is not compatible with typical dynamic optimization models. However, this approach is driven

by theory and the sense of ethical obligations to future generations, and not by the demands of a particular methodology. An appropriate discount rate outlined here will not impose such unacceptable costs. The GUMBO model specifically includes investment and output (of both goods and services and welfare) and thus allows us to calculate the actual average opportunity cost for total capital, both within and between time periods. Thus, we can endogenously calculate the appropriate discount rate in the GUMBO model. We will use GUMBO to test the hypothesis that an intertemporal discount rate based on the average rate of growth of the system guarantees sustainability, and that discount rates higher than that will cause the system to crash.

6. Acknowledgments

This project was sponsored by the National Center for Ecological Analysis and Synthesis (NCEAS), an NSF-funded Center at the University of California at Santa Barbara. The participants met during the weeks of June 1-5, 1998, June 1-6, 1999, and June 11-15, 2000 to perform the major parts of the synthesis activities. We thank Steve Farber and Matthias Ruth for valuable input and helpful comments on earlier drafts. Correspondence and requests for materials should be addressed to Roelof Boumans (e-mail: Boumans@cbl.umces.edu)

References:

- Arrow, K., Daily, G., Dasgupta, P., Levin, S., Maler, K-G., Maskin, E., Starrett, D., Sterner, T., Tietenberg, T., 2000. Managing ecosystem resources. *Environmental Science and Technology* 34,1401-1406
- Bairam, E., 1994. Homogeneous and nonhomogeneous production functions. Ashgate, Aldershot, Avebury, Brookfield, p. 146.
- Berkes, F., Folke, C., 1994. Investing in Cultural Capital for Sustainable Use of Natural Capital.. In: Jansson, A.M., Hammer, M., Folke, C., Costanza, R. (Eds.), *Investing in Natural Capital: The Ecological Economics Approach to Sustainability*. Island Press, Washington DC, p. 128-149
- Cline, W. ,1992. The economics of global warming. Institute for International Economics, Washington, DC., p. 399.
- Costanza, R., Arge, R., Groot, R., Farber, S., Grasso, M., Hannon, B., Limburg, K., Naeem, S., O'Neill, R.V., Paruelo, J., Raskin, R.R., Sutton, P., van den Belt, M., 1997. The value of the world's ecosystems services and natural capital. *Nature* 387, 253-269.
- Costanza, R., Cumberland, J., Daly, H., Goodland, R., Norgaard, R., 1997b. *An Introduction to Ecological Economics* St Lucie Press, Boca Raton.
- Costanza, R., Low, B., Ostrom, E., Wilson, J. (Eds.), 2001. *Institutions, Ecosystems, and Sustainability*. Lewis/CRC Press, Boca Ratom, FL., p. 270.
- Daily, G. (Ed.), 1997. *Nature's Services: Societal Dependence on Natural Ecosystems*. Island Press, Washington, D.C.
- de Groot, R.S., Wilson, M.A., Boumans, R., 2002. A typology for the classification description and valuation of ecosystem functions, goods and services. *Ecological Economics* 41, 393-408.
- Dent, J.B., Blakie, M.J., 1979. *Systems Simulation in Agriculture*. Applied Science Publishers, London.
- Forrester, J., 1971. *World dynamics*. MIT Press, Cambridge, MA.
- Frank R.H., 1999. *Luxury Fever: Why Money Fails to Satisfy in an Era of Excess*. Free Press, NY, p.326.
- Houghton, R.A., Boone, R.D., Fruci, J.R., Hobbie, J.E., Melillo, J.M., Palm, C.A., Peterson, B.J., Shaver, G.R., Woodwell, G.M. , Moore, B., Skole, D.L., Myers, N., 1987. The flux of carbon from terrestrial ecosystems to the atmosphere in 1980 due to changes in land use: Geographic distribution of the global flux. *Tellus* 39B, 122-139.
- IPCC. *Climate Change 1992: The Supplementary Report to the IPCC scientific assessment*, Cambridge University Press, Cambridge UK. 1992.
- IPCC, 1995. *Impacts, adaptations, and mitigation of climate change: scientific-technical analyses: contribution of working group II to the second assessment report of the Intergovernmental Panel on Climate Change*, Cambridge University Press, Cambridge UK.
- IPCC, 2001. *Summary for Policymakers: A report of Working Group I of the Intergovernmental Panel on Climate Change*. (<http://www.ipcc.ch/>)
- Limburg, K., O'Neill, R.V., Costanza, R., Farber, S. 2002. *Complex Systems and Valuation*. *Ecological Economics* (this volume)

- Lutz, W., Sanderson, W., Scherbov, S., 2001. The end of world population growth. *Nature* 412, 543-545.
- Meadows, D.H. 1985 Charting the Way the World Works. *Technology Review* 55-6
- Meadows, D.H., Meadows, D.L., Randers, J., Behrens, W.W., 1972. *The limits to growth*. Universe, New York.
- Meadows, D. L, Meadows, D.H., 1975 A Summary of Limits to Growth : Its Critics and Its Challenge. *Beyond Growth—Essays on Alternative Futures*. Yale University: School of Forestry and Environmental Studies Bulletin No. 88, New Haven : Yale University, p. 3-23.
- Meadows, D.H., Meadows, D.L., Randers, J., 1992. *Beyond the Limits: Confronting Global Collapse, Envisioning a Sustainable Future*. Chelsea Green, Post Mills, Vermont.
- Nordhaus, W.D. 1994. *Managing the global commons: The Economics of Climate Change*. The MIT press. Cambridge, MA, p. 213.
- Patterson, M. 2002. Ecological Production Based Pricing of Ecosystem Services *Ecological Economics* (this volume)
- Putnam, R. D. 2000. *Bowling Alone: The Collapse and Revival of American Community*. Simon and Schuster, New York.
- Rotmans, J., de Vries. B., 1997. *Perspectives on Global Change: The Targets Approach*. Cambridge University Press, Cambridge, UK.
- Serageldin, I., 1996. *Sustainability and the Wealth of Nations: First Steps in an Ongoing Journey*. Environmentally Sustainable Development Studies and Monograph Series No. 5, World Bank, Washington DC.
- Schlesinger, W.H., 1997. *Biogeochemistry: An Analysis of Global Change*. Academic Press Limited, San Diego, CA.
- Solow, R. 1974. Intergenerational equity and exhaustible resources. *Review of Economic Studies*, Symposium , 29-45.

APPENDIX C. RUMBA EQUATIONS

CarbonWithinSectorAtmosphere

```

Amazon_NEP_Carbon_Uptake[LandCovers, LandUses] = GPP[LandCovers, LandUses] -
Respiration_Autotrophs_Heterotrophs[LandCovers, LandUses]
Anthropogenic_Release_Forest = (Land_Cover_Harvest[AMF, NE] + Fires[AMF, NE]) / 1e9
Antropogenic_Carbon_Release[LandCovers, LandUses] =
Fires[LandCovers, LandUses] + Land_Use_Harvest[LandCovers, LandUses] + Land_Cover_Harvest[LandCov
ers, LandUses]
Carbon_Uptake_km2[LandCovers, LandUses] = IF AmazonLand[LandCovers, LandUses] = 0 THEN 0
ELSE Amazon_NEP_Carbon_Uptake[LandCovers, LandUses] / AmazonLand[LandCovers, LandUses]
Ecosystem_Uptake_Forest = (GPP[AMF, NE] -
(Autotroph_Resp[AMF, NE] + Heterothrop_Resp[AMF, NE])) / 1e9
Fires_in_Forest_Cultivated_Area = ((ARRAYSUM(Fires[AMF, *]) - Fires[AMF, NE])) / 1e9
Forest_LCLU_Anthro_Release = Anthropogenic_Release_Forest + Fires_in_Forest_Cultivated_Area
Forest_LCLU_Balance = Net_Carbon_Balance_Forest - Forest_LCLU_Anthro_Release
Net_Carbon_Balance = Total_Ecosystem_Uptake - Total_Antropogenic_Release
Net_Carbon_Balance_Forest = Ecosystem_Uptake_Forest - Anthropogenic_Release_Forest
Respiration_Autotrophs_Heterotrophs[LandCovers, LandUses] =
Autotroph_Resp[LandCovers, LandUses] + Respiration_Heterotrophs[LandCovers, LandUses]
Respiration_Heterotrophs[LandCovers, LandUses] =
Heterothrop_Resp[LandCovers, LandUses] + Consumer_Resp[LandCovers, LandUses]
Resp_Auto_Hetero_km2[LandCovers, LandUses] = IF AmazonLand[LandCovers, LandUses] = 0 THEN 0
ELSE
Respiration_Autotrophs_Heterotrophs[LandCovers, LandUses] / AmazonLand[LandCovers, LandUses]
Total_Antropogenic_Release = (ARRAYSUM(Antropogenic_Carbon_Release[AMF,
*]) + ARRAYSUM(Antropogenic_Carbon_Release[SAV,
*]) + ARRAYSUM(Antropogenic_Carbon_Release[RIV,
*]) + ARRAYSUM(Antropogenic_Carbon_Release[FLF, *])) / 1E9
Total_Ecosystem_Uptake = (ARRAYSUM(Amazon_NEP_Carbon_Uptake[AMF,
*]) + ARRAYSUM(Amazon_NEP_Carbon_Uptake[SAV,
*]) + ARRAYSUM(Amazon_NEP_Carbon_Uptake[RIV,
*]) + ARRAYSUM(Amazon_NEP_Carbon_Uptake[FLF, *])) / 1e9
Total_GPP = ARRAYSUM(GPP[AMF, *]) + ARRAYSUM(GPP[SAV, *]) + ARRAYSUM(GPP[RIV,
*]) + ARRAYSUM(GPP[FLF, *])
Water_respiration =
Respiration_Autotrophs_Heterotrophs[RIV, NE] + Respiration_Autotrophs_Heterotrophs[FLF, NE]

```

ChangeWithinSectorBiosphere

```

Autotrophs[LandCovers, LandUses](t) = Autotrophs[LandCovers, LandUses](t - dt) +
(GPP[LandCovers, LandUses] + New_Planting[LandCovers, LandUses] -
Autotroph_Resp[LandCovers, LandUses] - Autotroph_Mortality[LandCovers, LandUses] -
Land_Use_Harvest[LandCovers, LandUses] - Autotroph_Consumption[LandCovers, LandUses] -
Fires[LandCovers, LandUses] - Land_Cover_Harvest[LandCovers, LandUses]) * dt
INIT Autotrophs[LandCovers, LandUses] = IC_Autotroph_Carbon[LandCovers, LandUses]
INFLOWS:
GPP[LandCovers, LandUses] = IF AmazonLand[LandCovers, LandUses] = 0 THEN 0 ELSE
AmazonLand[LandCovers, LandUses] * GPP_Potential[LandCovers, LandUses] * Production_limits[LandCov
ers, LandUses]
New_Planting[LandCovers, LandUses] = IF New_Cultivated_Area[LandCovers, LandUses] <= 0 THEN 0
ELSE New_Cultivated_Area[LandCovers, LandUses] * Seeds[LandCovers, LandUses]
OUTFLOWS:
Autotroph_Resp[LandCovers, LandUses] =
GPP[LandCovers, LandUses] * Autotroph_Respiration_Rate[LandCovers, LandUses]

```

```

Autotroph_Mortality[LandCovers,LandUses] =
GPP[LandCovers,LandUses]*Autotroph_Mortality_Rate[LandCovers,LandUses]
Land_Use_Harvest[AMF,NE] = IF Autotrophs[AMF,NE]=0 THEN 0 ELSE
MAX(•Ease_of_Autothroph_Harvest[AMF,NE]*Autotrophs[AMF,NE],LCLU_Auto_Harv[AMF,NE])*0
Land_Use_Harvest[AMF,CR] = IF Autotrophs[AMF,CR]=0 THEN 0 ELSE
MAX(•Ease_of_Autothroph_Harvest[AMF,CR]*Autotrophs[AMF,CR],LCLU_Auto_Harv[AMF,CR])
Land_Use_Harvest[AMF,PA] = IF Autotrophs[AMF,PA]=0 THEN 0 ELSE
MAX(•Ease_of_Autothroph_Harvest[AMF,PA]*Autotrophs[AMF,PA],LCLU_Auto_Harv[AMF,PA])
Land_Use_Harvest[AMF,FA] = IF Autotrophs[AMF,FA]=0 THEN 0 ELSE
MAX(•Ease_of_Autothroph_Harvest[AMF,FA]*Autotrophs[AMF,FA],LCLU_Auto_Harv[AMF,FA])
Land_Use_Harvest[AMF,UR] = IF Autotrophs[AMF,UR]=0 THEN 0 ELSE
MAX(•Ease_of_Autothroph_Harvest[AMF,UR]*Autotrophs[AMF,UR],LCLU_Auto_Harv[AMF,UR])
Land_Use_Harvest[SAV,NE] = IF Autotrophs[SAV,NE]=0 THEN 0 ELSE
MAX(•Ease_of_Autothroph_Harvest[SAV,NE]*Autotrophs[SAV,NE],LCLU_Auto_Harv[SAV,NE])*0
Land_Use_Harvest[SAV,CR] = IF Autotrophs[SAV,CR]=0 THEN 0 ELSE
MAX(•Ease_of_Autothroph_Harvest[SAV,CR]*Autotrophs[SAV,CR],LCLU_Auto_Harv[SAV,CR])
Land_Use_Harvest[SAV,PA] = IF Autotrophs[SAV,PA]=0 THEN 0 ELSE
MAX(•Ease_of_Autothroph_Harvest[SAV,PA]*Autotrophs[SAV,PA],LCLU_Auto_Harv[SAV,PA])
Land_Use_Harvest[SAV,FA] = IF Autotrophs[SAV,FA]=0 THEN 0 ELSE
MAX(•Ease_of_Autothroph_Harvest[SAV,FA]*Autotrophs[SAV,FA],LCLU_Auto_Harv[SAV,FA])
Land_Use_Harvest[SAV,UR] = IF Autotrophs[SAV,UR]=0 THEN 0 ELSE
MAX(•Ease_of_Autothroph_Harvest[SAV,UR]*Autotrophs[SAV,UR],LCLU_Auto_Harv[SAV,UR])
Land_Use_Harvest[RIV,NE] = IF Autotrophs[RIV,NE]=0 THEN 0 ELSE
MAX(•Ease_of_Autothroph_Harvest[RIV,NE]*Autotrophs[RIV,NE],LCLU_Auto_Harv[RIV,NE])
Land_Use_Harvest[RIV,CR] = IF Autotrophs[RIV,CR]=0 THEN 0 ELSE
MAX(•Ease_of_Autothroph_Harvest[RIV,CR]*Autotrophs[RIV,CR],LCLU_Auto_Harv[RIV,CR])
Land_Use_Harvest[RIV,PA] = IF Autotrophs[RIV,PA]=0 THEN 0 ELSE
MAX(•Ease_of_Autothroph_Harvest[RIV,PA]*Autotrophs[RIV,PA],LCLU_Auto_Harv[RIV,PA])
Land_Use_Harvest[RIV,FA] = IF Autotrophs[RIV,FA]=0 THEN 0 ELSE
MAX(•Ease_of_Autothroph_Harvest[RIV,FA]*Autotrophs[RIV,FA],LCLU_Auto_Harv[RIV,FA])
Land_Use_Harvest[RIV,UR] = IF Autotrophs[RIV,UR]=0 THEN 0 ELSE
MAX(•Ease_of_Autothroph_Harvest[RIV,UR]*Autotrophs[RIV,UR],LCLU_Auto_Harv[RIV,UR])
Land_Use_Harvest[FLF,NE] = IF Autotrophs[FLF,NE]=0 THEN 0 ELSE
MAX(•Ease_of_Autothroph_Harvest[FLF,NE]*Autotrophs[FLF,NE],LCLU_Auto_Harv[FLF,NE])
Land_Use_Harvest[FLF,CR] = IF Autotrophs[FLF,CR]=0 THEN 0 ELSE
MAX(•Ease_of_Autothroph_Harvest[FLF,CR]*Autotrophs[FLF,CR],LCLU_Auto_Harv[FLF,CR])
Land_Use_Harvest[FLF,PA] = IF Autotrophs[FLF,PA]=0 THEN 0 ELSE
MAX(•Ease_of_Autothroph_Harvest[FLF,PA]*Autotrophs[FLF,PA],LCLU_Auto_Harv[FLF,PA])
Land_Use_Harvest[FLF,FA] = IF Autotrophs[FLF,FA]=0 THEN 0 ELSE
MAX(•Ease_of_Autothroph_Harvest[FLF,FA]*Autotrophs[FLF,FA],LCLU_Auto_Harv[FLF,FA])
Land_Use_Harvest[FLF,UR] = IF Autotrophs[FLF,UR]=0 THEN 0 ELSE
MAX(•Ease_of_Autothroph_Harvest[FLF,UR]*Autotrophs[FLF,UR],LCLU_Auto_Harv[FLF,UR])
Autotroph_Consumption[AMF,NE] = •Autotrophs_Consumption_Rate[AMF,NE]*GPP[AMF,NE]*0
Autotroph_Consumption[AMF,CR] = •Autotrophs_Consumption_Rate[AMF,CR]*GPP[AMF,CR]
Autotroph_Consumption[AMF,PA] = •Autotrophs_Consumption_Rate[AMF,PA]*GPP[AMF,PA]
Autotroph_Consumption[AMF,FA] = •Autotrophs_Consumption_Rate[AMF,FA]*GPP[AMF,FA]
Autotroph_Consumption[AMF,UR] = •Autotrophs_Consumption_Rate[AMF,UR]*GPP[AMF,UR]
Autotroph_Consumption[SAV,NE] = •Autotrophs_Consumption_Rate[SAV,NE]*GPP[SAV,NE]*0
Autotroph_Consumption[SAV,CR] = •Autotrophs_Consumption_Rate[SAV,CR]*GPP[SAV,CR]
Autotroph_Consumption[SAV,PA] = •Autotrophs_Consumption_Rate[SAV,PA]*GPP[SAV,PA]
Autotroph_Consumption[SAV,FA] = •Autotrophs_Consumption_Rate[SAV,FA]*GPP[SAV,FA]
Autotroph_Consumption[SAV,UR] = •Autotrophs_Consumption_Rate[SAV,UR]*GPP[SAV,UR]
Autotroph_Consumption[RIV,NE] = •Autotrophs_Consumption_Rate[RIV,NE]*GPP[RIV,NE]
Autotroph_Consumption[RIV,CR] = •Autotrophs_Consumption_Rate[RIV,CR]*GPP[RIV,CR]
Autotroph_Consumption[RIV,PA] = •Autotrophs_Consumption_Rate[RIV,PA]*GPP[RIV,PA]
Autotroph_Consumption[RIV,FA] = •Autotrophs_Consumption_Rate[RIV,FA]*GPP[RIV,FA]

```

Autotroph_Consumption[RIV,UR] = •Autotrophs_Consumption_Rate[RIV,UR]*GPP[RIV,UR]
 Autotroph_Consumption[FLF,NE] = •Autotrophs_Consumption_Rate[FLF,NE]*GPP[FLF,NE]
 Autotroph_Consumption[FLF,CR] = •Autotrophs_Consumption_Rate[FLF,CR]*GPP[FLF,CR]
 Autotroph_Consumption[FLF,PA] = •Autotrophs_Consumption_Rate[FLF,PA]*GPP[FLF,PA]
 Autotroph_Consumption[FLF,FA] = •Autotrophs_Consumption_Rate[FLF,FA]*GPP[FLF,FA]
 Autotroph_Consumption[FLF,UR] = •Autotrophs_Consumption_Rate[FLF,UR]*GPP[FLF,UR]
 Fires[LandCovers,LandUses] =
 Burned_Biomass[LandCovers,LandUses]*Burning_Efficiency[LandCovers,LandUses]
 Land_Cover_Harvest[AMF,NE] = IF AmazonLand[AMF,NE]=0 THEN 0 ELSE
 Annual_Def_Forest*Harvest_Ratio*Autotrophs[AMF,NE]/AmazonLand[AMF,NE]*•Ease_of_Autothroph
 _Harvest[AMF,NE]+Annual_Def_Savanna*Autotrophs[AMF,NE]/AmazonLand[AMF,NE]*•Ease_of_Aut
 othroph_Harvest[AMF,NE]*0
 Land_Cover_Harvest[AMF,CR] = IF AmazonLand[AMF,CR]=0 THEN 0 ELSE
 Annual_Def_Forest*Harvest_Ratio*Autotrophs[AMF,CR]/AmazonLand[AMF,CR]*•Ease_of_Autothroph
 _Harvest[AMF,CR]*0+Annual_Def_Savanna*Autotrophs[AMF,CR]/AmazonLand[AMF,CR]*•Ease_of_
 Autothroph_Harvest[AMF,CR]*0
 Land_Cover_Harvest[AMF,PA] = IF AmazonLand[AMF,PA]=0 THEN 0 ELSE
 Annual_Def_Forest*Harvest_Ratio*Autotrophs[AMF,PA]/AmazonLand[AMF,PA]*•Ease_of_Autothroph
 _Harvest[AMF,PA]*0+Annual_Def_Savanna*Autotrophs[AMF,PA]/AmazonLand[AMF,PA]*•Ease_of_A
 utothroph_Harvest[AMF,PA]*0
 Land_Cover_Harvest[AMF,FA] = IF AmazonLand[AMF,FA]=0 THEN 0 ELSE
 Annual_Def_Forest*Harvest_Ratio*Autotrophs[AMF,FA]/AmazonLand[AMF,FA]*•Ease_of_Autothroph
 _Harvest[AMF,FA]*0+Annual_Def_Savanna*Autotrophs[AMF,FA]/AmazonLand[AMF,FA]*•Ease_of_A
 utothroph_Harvest[AMF,FA]*0
 Land_Cover_Harvest[AMF,UR] = IF AmazonLand[AMF,UR]=0 THEN 0 ELSE
 Annual_Def_Forest*Harvest_Ratio*Autotrophs[AMF,UR]/AmazonLand[AMF,UR]*•Ease_of_Autothroph
 _Harvest[AMF,UR]*0+Annual_Def_Savanna*Autotrophs[AMF,UR]/AmazonLand[AMF,UR]*•Ease_of_
 Autothroph_Harvest[AMF,UR]*0
 Land_Cover_Harvest[SAV,NE] = IF AmazonLand[SAV,NE]=0 THEN 0 ELSE
 Annual_Def_Forest*Harvest_Ratio*Autotrophs[SAV,NE]/AmazonLand[SAV,NE]*•Ease_of_Autothroph
 _Harvest[SAV,NE]*0+Annual_Def_Savanna*Autotrophs[SAV,NE]/AmazonLand[SAV,NE]*•Ease_of_Aut
 othroph_Harvest[SAV,NE]
 Land_Cover_Harvest[SAV,CR] = IF AmazonLand[SAV,CR]=0 THEN 0 ELSE
 Annual_Def_Forest*Harvest_Ratio*Autotrophs[SAV,CR]/AmazonLand[SAV,CR]*•Ease_of_Autothroph
 _Harvest[SAV,CR]*0+Annual_Def_Savanna*Autotrophs[SAV,CR]/AmazonLand[SAV,CR]*•Ease_of_Aut
 othroph_Harvest[SAV,CR]*0
 Land_Cover_Harvest[SAV,PA] = IF AmazonLand[SAV,PA]=0 THEN 0 ELSE
 Annual_Def_Forest*Harvest_Ratio*Autotrophs[SAV,PA]/AmazonLand[SAV,PA]*•Ease_of_Autothroph
 _Harvest[SAV,PA]*0+Annual_Def_Savanna*Autotrophs[SAV,PA]/AmazonLand[SAV,PA]*•Ease_of_Aut
 othroph_Harvest[SAV,PA]*0
 Land_Cover_Harvest[SAV,FA] = IF AmazonLand[SAV,FA]=0 THEN 0 ELSE
 Annual_Def_Forest*Harvest_Ratio*Autotrophs[SAV,FA]/AmazonLand[SAV,FA]*•Ease_of_Autothroph
 _Harvest[SAV,FA]*0+Annual_Def_Savanna*Autotrophs[SAV,FA]/AmazonLand[SAV,FA]*•Ease_of_Aut
 othroph_Harvest[SAV,FA]*0
 Land_Cover_Harvest[SAV,UR] = IF AmazonLand[SAV,UR]=0 THEN 0 ELSE
 Annual_Def_Forest*Harvest_Ratio*Autotrophs[SAV,UR]/AmazonLand[SAV,UR]*•Ease_of_Autothroph
 _Harvest[SAV,UR]*0+Annual_Def_Savanna*Autotrophs[SAV,UR]/AmazonLand[SAV,UR]*•Ease_of_A
 utothroph_Harvest[SAV,UR]*0
 Land_Cover_Harvest[RIV,NE] = IF AmazonLand[RIV,NE]=0 THEN 0 ELSE
 Annual_Def_Forest*Harvest_Ratio*Autotrophs[RIV,NE]/AmazonLand[RIV,NE]*•Ease_of_Autothroph
 _Harvest[RIV,NE]*0+Annual_Def_Savanna*Autotrophs[RIV,NE]/AmazonLand[RIV,NE]*•Ease_of_Autot
 hroph_Harvest[RIV,NE]*0
 Land_Cover_Harvest[RIV,CR] = IF AmazonLand[RIV,CR]=0 THEN 0 ELSE
 Annual_Def_Forest*Harvest_Ratio*Autotrophs[RIV,CR]/AmazonLand[RIV,CR]*•Ease_of_Autothroph
 _Harvest[RIV,CR]*0+Annual_Def_Savanna*Autotrophs[RIV,CR]/AmazonLand[RIV,CR]*•Ease_of_Autot
 hroph_Harvest[RIV,CR]*0

Land_Cover_Harvest[RIV,PA] = IF AmazonLand[RIV,PA]=0 THEN 0 ELSE
 Annual_Def_Forest*Harvest_Ratio*Autotrophs[RIV,PA]/AmazonLand[RIV,PA]*Ease_of_Autotroph_Harvest[RIV,PA]*0+Annual_Def_Savanna*Autotrophs[RIV,PA]/AmazonLand[RIV,PA]*Ease_of_Autotroph_Harvest[RIV,PA]*0
 Land_Cover_Harvest[RIV,FA] = IF AmazonLand[RIV,FA]=0 THEN 0 ELSE
 Annual_Def_Forest*Harvest_Ratio*Autotrophs[RIV,FA]/AmazonLand[RIV,FA]*Ease_of_Autotroph_Harvest[RIV,FA]*0+Annual_Def_Savanna*Autotrophs[RIV,FA]/AmazonLand[RIV,FA]*Ease_of_Autotroph_Harvest[RIV,FA]*0
 Land_Cover_Harvest[RIV,UR] = IF AmazonLand[RIV,UR]=0 THEN 0 ELSE
 Annual_Def_Forest*Harvest_Ratio*Autotrophs[RIV,UR]/AmazonLand[RIV,UR]*Ease_of_Autotroph_Harvest[RIV,UR]*0+Annual_Def_Savanna*Autotrophs[RIV,UR]/AmazonLand[RIV,UR]*Ease_of_Autotroph_Harvest[RIV,UR]*0
 Land_Cover_Harvest[FLF,NE] = IF AmazonLand[FLF,NE]=0 THEN 0 ELSE
 Annual_Def_Forest*Harvest_Ratio*Autotrophs[FLF,NE]/AmazonLand[FLF,NE]*Ease_of_Autotroph_Harvest[FLF,NE]*0+Annual_Def_Savanna*Autotrophs[FLF,NE]/AmazonLand[FLF,NE]*Ease_of_Autotroph_Harvest[FLF,NE]*0
 Land_Cover_Harvest[FLF,CR] = IF AmazonLand[FLF,CR]=0 THEN 0 ELSE
 Annual_Def_Forest*Harvest_Ratio*Autotrophs[FLF,CR]/AmazonLand[FLF,CR]*Ease_of_Autotroph_Harvest[FLF,CR]*0+Annual_Def_Savanna*Autotrophs[FLF,CR]/AmazonLand[FLF,CR]*Ease_of_Autotroph_Harvest[FLF,CR]*0
 Land_Cover_Harvest[FLF,PA] = IF AmazonLand[FLF,PA]=0 THEN 0 ELSE
 Annual_Def_Forest*Harvest_Ratio*Autotrophs[FLF,PA]/AmazonLand[FLF,PA]*Ease_of_Autotroph_Harvest[FLF,PA]*0+Annual_Def_Savanna*Autotrophs[FLF,PA]/AmazonLand[FLF,PA]*Ease_of_Autotroph_Harvest[FLF,PA]*0
 Land_Cover_Harvest[FLF,FA] = IF AmazonLand[FLF,FA]=0 THEN 0 ELSE
 Annual_Def_Forest*Harvest_Ratio*Autotrophs[FLF,FA]/AmazonLand[FLF,FA]*Ease_of_Autotroph_Harvest[FLF,FA]*0+Annual_Def_Savanna*Autotrophs[FLF,FA]/AmazonLand[FLF,FA]*Ease_of_Autotroph_Harvest[FLF,FA]*0
 Land_Cover_Harvest[FLF,UR] = IF AmazonLand[FLF,UR]=0 THEN 0 ELSE
 Annual_Def_Forest*Harvest_Ratio*Autotrophs[FLF,UR]/AmazonLand[FLF,UR]*Ease_of_Autotroph_Harvest[FLF,UR]*0+Annual_Def_Savanna*Autotrophs[FLF,UR]/AmazonLand[FLF,UR]*Ease_of_Autotroph_Harvest[FLF,UR]*0
 Consumers[LandCovers,LandUses](t) = Consumers[LandCovers,LandUses](t - dt) +
 (Autotroph_Consumption[LandCovers,LandUses] - Consumer_Resp[LandCovers,LandUses] -
 Consumer_Mortality[LandCovers,LandUses] - Consumer_Harvest[LandCovers,LandUses]) * dt
 INIT Consumers[LandCovers,LandUses] = IC_Consumer_Carbon[LandCovers,LandUses]*10
 INFLOWS:
 Autotroph_Consumption[AMF,NE] = •Autotrophs_Consumption_Rate[AMF,NE]*GPP[AMF,NE]*0
 Autotroph_Consumption[AMF,CR] = •Autotrophs_Consumption_Rate[AMF,CR]*GPP[AMF,CR]
 Autotroph_Consumption[AMF,PA] = •Autotrophs_Consumption_Rate[AMF,PA]*GPP[AMF,PA]
 Autotroph_Consumption[AMF,FA] = •Autotrophs_Consumption_Rate[AMF,FA]*GPP[AMF,FA]
 Autotroph_Consumption[AMF,UR] = •Autotrophs_Consumption_Rate[AMF,UR]*GPP[AMF,UR]
 Autotroph_Consumption[SAV,NE] = •Autotrophs_Consumption_Rate[SAV,NE]*GPP[SAV,NE]*0
 Autotroph_Consumption[SAV,CR] = •Autotrophs_Consumption_Rate[SAV,CR]*GPP[SAV,CR]
 Autotroph_Consumption[SAV,PA] = •Autotrophs_Consumption_Rate[SAV,PA]*GPP[SAV,PA]
 Autotroph_Consumption[SAV,FA] = •Autotrophs_Consumption_Rate[SAV,FA]*GPP[SAV,FA]
 Autotroph_Consumption[SAV,UR] = •Autotrophs_Consumption_Rate[SAV,UR]*GPP[SAV,UR]
 Autotroph_Consumption[RIV,NE] = •Autotrophs_Consumption_Rate[RIV,NE]*GPP[RIV,NE]
 Autotroph_Consumption[RIV,CR] = •Autotrophs_Consumption_Rate[RIV,CR]*GPP[RIV,CR]
 Autotroph_Consumption[RIV,PA] = •Autotrophs_Consumption_Rate[RIV,PA]*GPP[RIV,PA]
 Autotroph_Consumption[RIV,FA] = •Autotrophs_Consumption_Rate[RIV,FA]*GPP[RIV,FA]
 Autotroph_Consumption[RIV,UR] = •Autotrophs_Consumption_Rate[RIV,UR]*GPP[RIV,UR]
 Autotroph_Consumption[FLF,NE] = •Autotrophs_Consumption_Rate[FLF,NE]*GPP[FLF,NE]
 Autotroph_Consumption[FLF,CR] = •Autotrophs_Consumption_Rate[FLF,CR]*GPP[FLF,CR]
 Autotroph_Consumption[FLF,PA] = •Autotrophs_Consumption_Rate[FLF,PA]*GPP[FLF,PA]
 Autotroph_Consumption[FLF,FA] = •Autotrophs_Consumption_Rate[FLF,FA]*GPP[FLF,FA]

Autotroph_Consumption[FLF,UR] = •Autotrophs_Consumption_Rate[FLF,UR]*GPP[FLF,UR]
 OUTFLOWS:
 Consumer_Resp[AMF,NE] = 0*Consumers[AMF,NE]*•Consumer_Resp_Rate[AMF,NE]
 Consumer_Resp[AMF,CR] = 0*Consumers[AMF,CR]*•Consumer_Resp_Rate[AMF,CR]
 Consumer_Resp[AMF,PA] = 0*Consumers[AMF,PA]*•Consumer_Resp_Rate[AMF,PA]
 Consumer_Resp[AMF,FA] = 0*Consumers[AMF,FA]*•Consumer_Resp_Rate[AMF,FA]
 Consumer_Resp[AMF,UR] = 0*Consumers[AMF,UR]*•Consumer_Resp_Rate[AMF,UR]
 Consumer_Resp[SAV,NE] = 0*Consumers[SAV,NE]*•Consumer_Resp_Rate[SAV,NE]
 Consumer_Resp[SAV,CR] = 0*Consumers[SAV,CR]*•Consumer_Resp_Rate[SAV,CR]
 Consumer_Resp[SAV,PA] = 0*Consumers[SAV,PA]*•Consumer_Resp_Rate[SAV,PA]
 Consumer_Resp[SAV,FA] = 0*Consumers[SAV,FA]*•Consumer_Resp_Rate[SAV,FA]
 Consumer_Resp[SAV,UR] = 0*Consumers[SAV,UR]*•Consumer_Resp_Rate[SAV,UR]
 Consumer_Resp[RIV,NE] = Consumers[RIV,NE]*•Consumer_Resp_Rate[RIV,NE]
 Consumer_Resp[RIV,CR] = 0*Consumers[RIV,CR]*•Consumer_Resp_Rate[RIV,CR]
 Consumer_Resp[RIV,PA] = 0*Consumers[RIV,PA]*•Consumer_Resp_Rate[RIV,PA]
 Consumer_Resp[RIV,FA] = 0*Consumers[RIV,FA]*•Consumer_Resp_Rate[RIV,FA]
 Consumer_Resp[RIV,UR] = 0*Consumers[RIV,UR]*•Consumer_Resp_Rate[RIV,UR]
 Consumer_Resp[FLF,NE] = Consumers[FLF,NE]*•Consumer_Resp_Rate[FLF,NE]
 Consumer_Resp[FLF,CR] = 0*Consumers[FLF,CR]*•Consumer_Resp_Rate[FLF,CR]
 Consumer_Resp[FLF,PA] = 0*Consumers[FLF,PA]*•Consumer_Resp_Rate[FLF,PA]
 Consumer_Resp[FLF,FA] = 0*Consumers[FLF,FA]*•Consumer_Resp_Rate[FLF,FA]
 Consumer_Resp[FLF,UR] = 0*Consumers[FLF,UR]*•Consumer_Resp_Rate[FLF,UR]
 Consumer_Mortality[LandCovers,LandUses] =
 •Consumer_Mort_Rate[LandCovers,LandUses]*Consumers[LandCovers,LandUses]
 Consumer_Harvest[LandCovers,LandUses] =
 MIN(•Ease_of_consumer_harvest[LandCovers,LandUses]*Consumers[LandCovers,LandUses],
 LCLU_Cons_Harv[LandCovers,LandUses]*1e6)
 Dead_OM[LandCovers,LandUses](t) = Dead_OM[LandCovers,LandUses](t - dt) +
 (Decomposer_Mortality[LandCovers,LandUses] + Consumer_Mortality[LandCovers,LandUses] +
 Autotroph_Mortality[LandCovers,LandUses] - Decomposer_Growth[LandCovers,LandUses] -
 Org_Soil_Formation[LandCovers,LandUses] - TOM_Spatial_Exchange[LandCovers,LandUses]) * dt
 INIT Dead_OM[LandCovers,LandUses] =
 IC_Dead_Org_Matter_Carbon[LandCovers,LandUses]*IC_LCLU[LandCovers,LandUses]
 INFLOWS:
 Decomposer_Mortality[LandCovers,LandUses] =
 •Decomposer_Mort_Rate[LandCovers,LandUses]*Decomposers[LandCovers,LandUses]
 Consumer_Mortality[LandCovers,LandUses] =
 •Consumer_Mort_Rate[LandCovers,LandUses]*Consumers[LandCovers,LandUses]
 Autotroph_Mortality[LandCovers,LandUses] =
 GPP[LandCovers,LandUses]*•Autotroph_Mortality_Rate[LandCovers,LandUses]
 OUTFLOWS:
 Decomposer_Growth[LandCovers,LandUses] =
 Decomposer_Growth_Rate[LandCovers,LandUses]*Dead_OM[LandCovers,LandUses]
 Org_Soil_Formation[LandCovers,LandUses] =
 Dead_OM[LandCovers,LandUses]*•Rate_of_Soil_Humus_Formation[LandCovers,LandUses]
 TOM_Spatial_Exchange[LandCovers,LandUses] =
 (Dead_OM[LandCovers,LandUses]*•TOM_Spatial_Redistr_Rate[LandCovers,LandUses]) -
 (Andean_TOM[LandCovers,LandUses])
 Decomposers[LandCovers,LandUses](t) = Decomposers[LandCovers,LandUses](t - dt) +
 (Decomposer_Growth[LandCovers,LandUses] - Heterothrop_Resp[LandCovers,LandUses] -
 Decomposer_Mortality[LandCovers,LandUses]) * dt
 INIT Decomposers[LandCovers,LandUses] = IC_Decomposer_Carbon[LandCovers,LandUses]*10
 INFLOWS:
 Decomposer_Growth[LandCovers,LandUses] =
 Decomposer_Growth_Rate[LandCovers,LandUses]*Dead_OM[LandCovers,LandUses]
 OUTFLOWS:

```

Heterothrop_Resp[LandCovers,LandUses] =
•Decomposer_Respiration_Rate[LandCovers,LandUses]*GPP[LandCovers,LandUses]
Decomposer_Mortality[LandCovers,LandUses] =
•Decomposer_Mort_Rate[LandCovers,LandUses]*Decomposers[LandCovers,LandUses]
Above_Ground_Biomass[AMF,NE] = 32600
Above_Ground_Biomass[AMF,CR] = 900
Above_Ground_Biomass[AMF,PA] = 1500
Above_Ground_Biomass[AMF,FA] = 7600
Above_Ground_Biomass[AMF,UR] = 300
Above_Ground_Biomass[SAV,NE] = 2600
Above_Ground_Biomass[SAV,CR] = 1200
Above_Ground_Biomass[SAV,PA] = 1200
Above_Ground_Biomass[SAV,FA] = 1200
Above_Ground_Biomass[SAV,UR] = 300
Above_Ground_Biomass[RIV,NE] = 600
Above_Ground_Biomass[RIV,CR] = 0
Above_Ground_Biomass[RIV,PA] = 0
Above_Ground_Biomass[RIV,FA] = 0
Above_Ground_Biomass[RIV,UR] = 0
Above_Ground_Biomass[FLF,NE] = 3600
Above_Ground_Biomass[FLF,CR] = 0
Above_Ground_Biomass[FLF,PA] = 0
Above_Ground_Biomass[FLF,FA] = 0
Above_Ground_Biomass[FLF,UR] = 0
AMAZON_TOTAL_BIOMASS = ARRAYSUM(TOTAL_AUTO_BIOMASS_ON_LCLU[*,*])
AMAZON_TOTAL_CARBON =
TOTAL_CARBON_ON_LCLU[AMF,NE]+TOTAL_CARBON_ON_LCLU[AMF,CR]+TOTAL_CARBO
N_ON_LCLU[AMF,PA]+TOTAL_CARBON_ON_LCLU[AMF,FA]+TOTAL_CARBON_ON_LCLU[A
MF,UR]+
TOTAL_CARBON_ON_LCLU[SAV,NE]+TOTAL_CARBON_ON_LCLU[SAV,CR]+TOTAL_CARBO
N_ON_LCLU[SAV,PA]+TOTAL_CARBON_ON_LCLU[SAV,FA]+TOTAL_CARBON_ON_LCLU[SA
V,UR]+TOTAL_CARBON_ON_LCLU[RIV,NE]+TOTAL_CARBON_ON_LCLU[FLF,NE]
Andean_TOM[AMF,NE] = 0
Andean_TOM[AMF,CR] = 0
Andean_TOM[AMF,PA] = 0
Andean_TOM[AMF,FA] = 0
Andean_TOM[AMF,UR] = 0
Andean_TOM[SAV,NE] = 0
Andean_TOM[SAV,CR] = 0
Andean_TOM[SAV,PA] = 0
Andean_TOM[SAV,FA] = 0
Andean_TOM[SAV,UR] = 0
Andean_TOM[RIV,NE] = (6.8E6+5.3E6)
Andean_TOM[RIV,CR] = 0
Andean_TOM[RIV,PA] = 0
Andean_TOM[RIV,FA] = 0
Andean_TOM[RIV,UR] = 0
Andean_TOM[FLF,NE] = 0
Andean_TOM[FLF,CR] = 0
Andean_TOM[FLF,PA] = 0
Andean_TOM[FLF,FA] = 0
Andean_TOM[FLF,UR] = 0
Annual_Biomass_Harvest_from_Def = Annual_Def_Forest*Auto_km2[AMF,NE]/1e9
Anthropogenic_Emissions = Total_Emissions_from_Fire+Total_Emissions_from_Harvest
Auto_km2[LandCovers,LandUses] = IF(AmazonLand[LandCovers,LandUses]=0) THEN 0 ELSE
Autotrophs[LandCovers,LandUses]/AmazonLand[LandCovers,LandUses]

```

```

Auto_Mort_km2[LandCovers,LandUses] = IF(AmazonLand[LandCovers,LandUses]=0) THEN 0 ELSE
Autotroph_Mortality[LandCovers,LandUses]/AmazonLand[LandCovers,LandUses]
Auto_Resp_Km2[LandCovers,LandUses] = IF(AmazonLand[LandCovers,LandUses]=0) THEN 0 ELSE
Autotroph_Resp[LandCovers,LandUses]/AmazonLand[LandCovers,LandUses]
Below&Above_Biomass[LandCovers,LandUses] =
Above_Ground_Biomass[LandCovers,LandUses]+Below_Ground_Biomass[LandCovers,LandUses]
Below_&_Above_Biomass[LandCovers,LandUses] =
Above_Ground_Biomass[LandCovers,LandUses]+Below_Ground_Biomass[LandCovers,LandUses]
Below_Ground_Biomass[AMF,NE] = 10900
Below_Ground_Biomass[AMF,CR] = 200
Below_Ground_Biomass[AMF,PA] = 200
Below_Ground_Biomass[AMF,FA] = 1300
Below_Ground_Biomass[AMF,UR] = 100
Below_Ground_Biomass[SAV,NE] = 4100
Below_Ground_Biomass[SAV,CR] = 200
Below_Ground_Biomass[SAV,PA] = 200
Below_Ground_Biomass[SAV,FA] = 1200
Below_Ground_Biomass[SAV,UR] = 100
Below_Ground_Biomass[RIV,NE] = 1
Below_Ground_Biomass[RIV,CR] = 1
Below_Ground_Biomass[RIV,PA] = 1
Below_Ground_Biomass[RIV,FA] = 1
Below_Ground_Biomass[RIV,UR] = 1
Below_Ground_Biomass[FLF,NE] = 3600
Below_Ground_Biomass[FLF,CR] = 1
Below_Ground_Biomass[FLF,PA] = 1
Below_Ground_Biomass[FLF,FA] = 1
Below_Ground_Biomass[FLF,UR] = 1
Biomass_Burning_Rate[LandCovers,LandUses] = 0.1
Burned_Biomass[LandCovers,LandUses] =
(•Forest_Burning[LandCovers,LandUses]*Annual_Def_Forest*Below_&_Above_Biomass[LandCovers,L
andUses]*•Accidental_Fire[LandCovers,LandUses]+•Savanna_Burning[LandCovers,LandUses]*Annual_
Def_Savanna*Below_&_Above_Biomass[LandCovers,LandUses]+•Agricultural_Burning[LandCovers,La
ndUses]*AmazonLand[LandCovers,LandUses]*Below_&_Above_Biomass[LandCovers,LandUses]+•Past
ure_Burning[LandCovers,LandUses]*AmazonLand[LandCovers,LandUses]*Below_&_Above_Biomass[L
andCovers,LandUses]+•Fallow_Burning[LandCovers,LandUses]*AmazonLand[LandCovers,LandUses]*B
elow_&_Above_Biomass[LandCovers,LandUses])
Burning_Efficiency[LandCovers,LandUses] =
Biomass_Burning_Rate[LandCovers,LandUses]*Percentage_of_ABGB[LandCovers,LandUses]
C:N_Ratio_Above_Ground_Biomass[LandCovers,LandUses] =
•C_Fraction_Above_Ground_Biomass[LandCovers,LandUses]/•N_Fraction_Above_Ground_Biomass[Lan
dCovers,LandUses]
C:N_Ratio_Below_Ground_Biomass[LandCovers,LandUses] =
•C_Fraction_Below_Ground_Biomass[LandCovers,LandUses]/•N_Fraction_Below_Ground_Biomass[Lan
dCovers,LandUses]
C:N_Ratio_rivers = 27
Carbon_Above_Ground_Vegetation_Biomass[LandCovers,LandUses] =
Above_Ground_Biomass[LandCovers,LandUses]*•C_Fraction_Above_Ground_Biomass[LandCovers,Lan
dUses]
Carbon_Below_Ground_Biomass[LandCovers,LandUses] =
Below_Ground_Biomass[LandCovers,LandUses]*•C_Fraction_Below_Ground_Biomass[LandCovers,Lan
dUses]
Carbon_LF[LandCovers,LandUses] = IF
Bioavailable_IOC[LandCovers,LandUses]>•Max_C[LandCovers,LandUses] OR
Bioavailable_IOC[LandCovers,LandUses]<•Min_C[LandCovers,LandUses] THEN 0 ELSE

```

```

ABS((Bioavailable_IOC[LandCovers,LandUses]-
•Opt_C[LandCovers,LandUses])/•Opt_C[LandCovers,LandUses])
Cons_km2[LandCovers,LandUses] = IF(AmazonLand[LandCovers,LandUses]=0) THEN 0 ELSE
Consumers[LandCovers,LandUses]/AmazonLand[LandCovers,LandUses]
Cons_Resp_km2[LandCovers,LandUses] = IF AmazonLand[LandCovers,LandUses]=0 THEN 0 ELSE
Consumer_Resp[LandCovers,LandUses]/AmazonLand[LandCovers,LandUses]
Dead_OM_&_Decomp_km2[LandCovers,LandUses] =
Dead_OM_km2[LandCovers,LandUses]+Decomposers_km2[LandCovers,LandUses]
Dead_OM_km2[LandCovers,LandUses] = IF(AmazonLand[LandCovers,LandUses]=0) THEN 0 ELSE
Dead_OM[LandCovers,LandUses]/AmazonLand[LandCovers,LandUses]
Decomposers_km2[LandCovers,LandUses] = IF(AmazonLand[LandCovers,LandUses]=0) THEN 0 ELSE
Decomposers[LandCovers,LandUses]/AmazonLand[LandCovers,LandUses]
Decomposer_Growth_Rate[LandCovers,LandUses] =
•Decomposer_Growth_Rate[LandCovers,LandUses]*•Decomposing_LF[LandCovers,LandUses]
Drought[LandCovers,LandUses] = IF Saturation_Deficit_Depth[LandCovers,LandUses] >=
•Drought_Tolerance[LandCovers,LandUses] THEN 1 ELSE
Saturation_Deficit_Depth[LandCovers,LandUses]/•Drought_Tolerance[LandCovers,LandUses]
Emissions_from_Forest_Change = (Fires[AMF,NE]/1e9+Emissions_from_Harvest[AMF,NE])
Emissions_from_Harvest[LandCovers,LandUses] =
(Land_Cover_Harvest[LandCovers,LandUses]/1e9+Land_Use_Harvest[LandCovers,LandUses]/1e9)
Emissions_from_Land_Cover_Change =
Emissions_from_Forest_Change+Emissions_from_Savanna_Change
Emissions_from_Land_Use =
ARRAYSUM(Fires[*,*])/1e9+ARRAYSUM(Emissions_from_Harvest[*,*])-
Emissions_from_Land_Cover_Change
Emissions_from_Savanna_Change = (Fires[SAV,NE]/1e9+Emissions_from_Harvest[SAV,NE])
Energy_LF[LandCovers,LandUses] = IF
Light_to_Autotrophs[LandCovers,LandUses]>•Max_Light[LandCovers,LandUses]OR
Light_to_Autotrophs[LandCovers,LandUses]<•Min_Light[LandCovers,LandUses] THEN 0 ELSE 1-
ABS((Light_to_Autotrophs[LandCovers,LandUses]-
•Opt_Light[LandCovers,LandUses])/(Light_to_Autotrophs[LandCovers,LandUses]+•Opt_Light[LandCove
rs,LandUses]))
Extinction[LandCovers,LandUses] =
MIN(1,(•EC_Coeff_Autotr[LandCovers,LandUses]*Norm_BM[LandCovers,LandUses]+•EC__coeff_medi
um[LandCovers,LandUses]))
Fire_Trigger[LandCovers,LandUses] = IF Drought[LandCovers,LandUses]<=1 then 1.0 ELSE 0
Flood[LandCovers,LandUses] = IF Water_Depth[LandCovers,LandUses] =0 OR
Water_Depth[LandCovers,LandUses]<= •Flood_tolerance[LandCovers,LandUses] THEN 1 ELSE
•Flood_tolerance[LandCovers,LandUses]/Water_Depth[LandCovers,LandUses]
GPP_km2[LandCovers,LandUses] = IF AmazonLand[LandCovers,LandUses]=0 THEN 0 ELSE
GPP[LandCovers,LandUses]/AmazonLand[LandCovers,LandUses]
GPP_Potential[LandCovers,LandUses] = 10^(0.24*•Chloro_Conc_Rate[LandCovers,LandUses]+2.19)*2
GPP_Pot_km2[LandCovers,LandUses] = IF AmazonLand[LandCovers,LandUses]=0 THEN 0 ELSE
GPP_Potential[LandCovers,LandUses]/GPP_Potential[LandCovers,LandUses]
Growth_Temp[LandCovers,LandUses] =
MAX(Regional_Temperature,•Water_Temp[LandCovers,LandUses])
Harvest_Ratio = 1.5
Hetero_Resp_km2[LandCovers,LandUses] =
Het_Resp_km2[LandCovers,LandUses]+Cons_Resp_km2[LandCovers,LandUses]
Het_Resp_km2[LandCovers,LandUses] = IF(AmazonLand[LandCovers,LandUses]=0) THEN 0 ELSE
Heterothrop_Resp[LandCovers,LandUses]/AmazonLand[LandCovers,LandUses]
IC_Autotroph_Biomass[LandCovers,LandUses] =
TOTAL_AUTO_BIOMASS_ON_LCLU[LandCovers,LandUses]*•Autotrophs_Rate[LandCovers,LandUse
s]
IC_Autotroph_Carbon[LandCovers,LandUses] = IC_Autotroph_Biomass[LandCovers,LandUses]*0.45

```

$IC_Auto_Carbon_km2[LandCovers, LandUses] = IF\ IC_LCLU[LandCovers, LandUses]=0\ THEN\ 0\ ELSE\ IC_Autotroph_Carbon[LandCovers, LandUses]/IC_LCLU[LandCovers, LandUses]$
 $IC_CARBON[LandCovers, LandUses] =$
 $TOTAL_AUTO_BIOMASS_ON_LCLU[LandCovers, LandUses]*0.45$
 $IC_Consumer_Biomass[LandCovers, LandUses] =$
 $\bullet Consumers_Rate[LandCovers, LandUses]*TOTAL_AUTO_BIOMASS_ON_LCLU[LandCovers, LandUses]$
 $IC_Consumer_Carbon[LandCovers, LandUses] = IC_Consumer_Biomass[LandCovers, LandUses]*0.45$
 $IC_Dead_Org_Matter_Carbon[LandCovers, LandUses] =$
 $IC_Dead_Org_Matter[LandCovers, LandUses]*0.45$
 $IC_Dead_Org_Matter[LandCovers, LandUses] = Non_Living_Biomass[LandCovers, LandUses]$
 $IC_Decomposer_Biomass[LandCovers, LandUses] =$
 $\bullet Decomposers_Rate[LandCovers, LandUses]*TOTAL_AUTO_BIOMASS_ON_LCLU[LandCovers, LandUses]$
 $IC_Decomposer_Carbon[LandCovers, LandUses] =$
 $IC_Decomposer_Biomass[LandCovers, LandUses]*0.45$
 $Insolation[LandCovers, LandUses] = 1555*12$
 $Light_to_Autotrophs[LandCovers, LandUses] = PAR[LandCovers, LandUses]*EXP(-$
 $Extintion[LandCovers, LandUses]*MAX(0, \bullet Light_Depth[LandCovers, LandUses]))$
 $Max_shading[LandCovers, LandUses] = IF\ IC_Autotroph_Biomass[LandCovers, LandUses]=0\ THEN\ 1$
 $ELSE\ 2*IC_Autotroph_Biomass[LandCovers, LandUses]$
 $N:C_Ratio_Below_Ground_Biomass[LandCovers, LandUses] =$
 $\bullet N_Fraction_Below_Ground_Biomass[LandCovers, LandUses]/\bullet C_Fraction_Below_Ground_Biomass[LandCovers, LandUses]$
 $N:C_Ratio_Above_Ground_Biomass[LandCovers, LandUses] =$
 $\bullet N_Fraction_Above_Ground_Biomass[LandCovers, LandUses]/\bullet C_Fraction_Above_Ground_Biomass[LandCovers, LandUses]$
 $Net_Ecosystem_Production_NEP_km2[LandCovers, LandUses] = IF$
 $AmazonLand[LandCovers, LandUses]=0\ THEN\ 0\ ELSE\ (GPP[LandCovers, LandUses]-$
 $(Autotroph_Resp[LandCovers, LandUses]+Heterothrop_Resp[LandCovers, LandUses])/AmazonLand[LandCovers, LandUses]$
 $New_Cultivated_Area[AMF, NE] = 0*(AmazonLand[AMF, NE]-DELAY(AmazonLand[AMF, NE], 1))$
 $New_Cultivated_Area[AMF, CR] = (AmazonLand[AMF, CR]-DELAY(AmazonLand[AMF, CR], 1))$
 $New_Cultivated_Area[AMF, PA] = (AmazonLand[AMF, PA]-DELAY(AmazonLand[AMF, PA], 1))$
 $New_Cultivated_Area[AMF, FA] = (AmazonLand[AMF, FA]-DELAY(AmazonLand[AMF, FA], 1))$
 $New_Cultivated_Area[AMF, UR] = (AmazonLand[AMF, UR]-DELAY(AmazonLand[AMF, UR], 1))$
 $New_Cultivated_Area[SAV, NE] = 0*(AmazonLand[SAV, NE]-DELAY(AmazonLand[SAV, NE], 1))$
 $New_Cultivated_Area[SAV, CR] = (AmazonLand[SAV, CR]-DELAY(AmazonLand[SAV, CR], 1))$
 $New_Cultivated_Area[SAV, PA] = (AmazonLand[SAV, PA]-DELAY(AmazonLand[SAV, PA], 1))$
 $New_Cultivated_Area[SAV, FA] = (AmazonLand[SAV, FA]-DELAY(AmazonLand[SAV, FA], 1))$
 $New_Cultivated_Area[SAV, UR] = (AmazonLand[SAV, UR]-DELAY(AmazonLand[SAV, UR], 1))$
 $New_Cultivated_Area[RIV, NE] = (AmazonLand[RIV, NE]-DELAY(AmazonLand[RIV, NE], 1))$
 $New_Cultivated_Area[RIV, CR] = (AmazonLand[RIV, CR]-DELAY(AmazonLand[RIV, CR], 1))$
 $New_Cultivated_Area[RIV, PA] = (AmazonLand[RIV, PA]-DELAY(AmazonLand[RIV, PA], 1))$
 $New_Cultivated_Area[RIV, FA] = (AmazonLand[RIV, FA]-DELAY(AmazonLand[RIV, FA], 1))$
 $New_Cultivated_Area[RIV, UR] = (AmazonLand[RIV, UR]-DELAY(AmazonLand[RIV, UR], 1))$
 $New_Cultivated_Area[FLF, NE] = (AmazonLand[FLF, NE]-DELAY(AmazonLand[FLF, NE], 1))$
 $New_Cultivated_Area[FLF, CR] = (AmazonLand[FLF, CR]-DELAY(AmazonLand[FLF, CR], 1))$
 $New_Cultivated_Area[FLF, PA] = (AmazonLand[FLF, PA]-DELAY(AmazonLand[FLF, PA], 1))$
 $New_Cultivated_Area[FLF, FA] = (AmazonLand[FLF, FA]-DELAY(AmazonLand[FLF, FA], 1))$
 $New_Cultivated_Area[FLF, UR] = (AmazonLand[FLF, UR]-DELAY(AmazonLand[FLF, UR], 1))$
 $Nitrogen_Above_Ground_Vegetation_Biomass[LandCovers, LandUses] =$
 $Above_Ground_Biomass[LandCovers, LandUses]*\bullet N_Fraction_Above_Ground_Biomass[LandCovers, LandUses]$

```

Nitrogen_Below_Ground_Biomass[LandCovers,LandUses] =
Below_Ground_Biomass[LandCovers,LandUses]*N_Fraction_Below_Ground_Biomass[LandCovers,LandUses]
Non_Living_Biomass[AMF,NE] = 4985
Non_Living_Biomass[AMF,CR] = 223
Non_Living_Biomass[AMF,PA] = 1472
Non_Living_Biomass[AMF,FA] = 1270
Non_Living_Biomass[AMF,UR] = 0
Non_Living_Biomass[SAV,NE] = 428
Non_Living_Biomass[SAV,CR] = 0
Non_Living_Biomass[SAV,PA] = 0
Non_Living_Biomass[SAV,FA] = 0
Non_Living_Biomass[SAV,UR] = 0
Non_Living_Biomass[RIV,NE] = 0
Non_Living_Biomass[RIV,CR] = 0
Non_Living_Biomass[RIV,PA] = 0
Non_Living_Biomass[RIV,FA] = 0
Non_Living_Biomass[RIV,UR] = 0
Non_Living_Biomass[FLF,NE] = 0
Non_Living_Biomass[FLF,CR] = 0
Non_Living_Biomass[FLF,PA] = 0
Non_Living_Biomass[FLF,FA] = 0
Non_Living_Biomass[FLF,UR] = 0
Norm_BM[LandCovers,LandUses] = IF Max_shading[LandCovers,LandUses]=0 THEN 0 ELSE
Autotrophs[FLF,UR]/Max_shading[FLF,UR]
NPP[AMF,NE] = GPP[AMF,NE]-Autotroph_Resp[AMF,NE]
NPP[AMF,CR] = GPP[AMF,CR]-Autotroph_Resp[AMF,CR]
NPP[AMF,PA] = GPP[AMF,PA]-Autotroph_Resp[AMF,PA]
NPP[AMF,FA] = GPP[AMF,FA]-Autotroph_Resp[AMF,FA]
NPP[AMF,UR] = GPP[AMF,UR]-Autotroph_Resp[AMF,UR]
NPP[SAV,NE] = GPP[SAV,NE]-Autotroph_Resp[SAV,NE]
NPP[SAV,CR] = GPP[SAV,CR]-Autotroph_Resp[SAV,CR]
NPP[SAV,PA] = GPP[SAV,PA]-Autotroph_Resp[SAV,PA]
NPP[SAV,FA] = GPP[SAV,FA]-Autotroph_Resp[SAV,FA]
NPP[SAV,UR] = GPP[SAV,UR]-Autotroph_Resp[SAV,UR]
NPP[RIV,NE] = GPP[RIV,NE]-Autotroph_Resp[RIV,NE]
NPP[RIV,CR] = GPP[RIV,CR]-Autotroph_Resp[RIV,CR]
NPP[RIV,PA] = GPP[RIV,PA]-Autotroph_Resp[RIV,PA]
NPP[RIV,FA] = GPP[RIV,FA]-Autotroph_Resp[RIV,FA]
NPP[RIV,UR] = GPP[RIV,UR]-Autotroph_Resp[RIV,UR]
NPP[FLF,NE] = GPP[FLF,NE]-Autotroph_Resp[FLF,NE]
NPP[FLF,CR] = GPP[FLF,CR]-Autotroph_Resp[FLF,CR]
NPP[FLF,PA] = GPP[FLF,PA]-Autotroph_Resp[FLF,PA]
NPP[FLF,FA] = GPP[FLF,FA]-Autotroph_Resp[FLF,FA]
NPP[FLF,UR] = GPP[FLF,UR]-Autotroph_Resp[FLF,UR]
NPP_km2[LandCovers,LandUses] = IF(AmazonLand[LandCovers,LandUses]=0) THEN 0 ELSE
NPP[LandCovers,LandUses]/AmazonLand[LandCovers,LandUses]
Nutrient_LF[LandCovers,LandUses] =
MIN(1,SOIL_Nutrients[LandCovers,LandUses]/(GPP_Potential[LandCovers,LandUses]*NContent_of_Biomass[LandCovers,LandUses]))
OM_Produced = (ARRAYSUM(Organic_Matter_Produced[AMF,*])+ARRAYSUM(Organic_Matter_Produced[SAV,*])+ARRAYSUM(Organic_Matter_Produced[RIV,*])+ARRAYSUM(Organic_Matter_Produced[FLF,*]))
Organic_Matter_Produced[LandCovers,LandUses] =
(Land_Use_Harvest[LandCovers,LandUses]+Consumer_Harvest[LandCovers,LandUses])/1E6
PAR[LandCovers,LandUses] = (1-Clouds[LandCovers,LandUses])*Insolation[LandCovers,LandUses]

```

```

Percentage_of_ABGB[LandCovers,LandUses] =
Above_Ground_Biomass[LandCovers,LandUses]/Below_&_Above_Biomass[LandCovers,LandUses]
Production_limits[LandCovers,LandUses] =
MIN((Nutrient_LF[LandCovers,LandUses]+Temp_LF[LandCovers,LandUses]+Water_LF[LandCovers,La
ndUses]+Carbon_LF[LandCovers,LandUses]+Waste_LF[LandCovers,LandUses]/5),Energy_LF[LandCov
ers,LandUses])
Saturation_Deficit_Depth[LandCovers,LandUses] = IF AmazonLand[LandCovers,LandUses]=0 THEN 0
ELSE Saturation_Deficit[LandCovers,LandUses]/(AmazonLand[LandCovers,LandUses]*1E6)
Seeds[LandCovers,LandUses] = 1*IC_Auto_Carbon_km2[LandCovers,LandUses]
Temp_LF[LandCovers,LandUses] = IF
Growth_Temp[LandCovers,LandUses]>•T_Max[LandCovers,LandUses]OR
Growth_Temp[LandCovers,LandUses]<•T_Min[LandCovers,LandUses] THEN 0 ELSE 1-
ABS((Growth_Temp[LandCovers,LandUses]-
•T_Opt[LandCovers,LandUses])/(Growth_Temp[LandCovers,LandUses]+•T_Opt[LandCovers,LandUses])
)
TNU = ARRAYSUM(Total_Net_Ecosystem_Production[*,*])
Total_AutoGPP = ARRAYSUM(GPP[*,*])
Total_Autothrops = ARRAYSUM(Autotrophs[*,*])
TOTAL_AUTO_BIOMASS_ON_LCLU[LandCovers,LandUses] =
Below&Above_Biomass[LandCovers,LandUses]*IC_LCLU[LandCovers,LandUses]
Total_Auto_Cons = ARRAYSUM(Autotroph_Consumption[*,*])
Total_Auto_Mort = ARRAYSUM(Autotroph_Mortality[*,*])
Total_Auto_Resp = ARRAYSUM(Autotroph_Resp[*,*])
Total_Burned_Biomass = ARRAYSUM(Fires[*,*])
TOTAL_CARBON_ON_LCLU[LandCovers,LandUses] =
TOTAL_AUTO_BIOMASS_ON_LCLU[LandCovers,LandUses]*0.45
Total_Consumers = ARRAYSUM(Consumers[*,*])
Total_Cons_Harvest = ARRAYSUM(Consumer_Harvest[AMF,
*])+ARRAYSUM(Consumer_Harvest[SAV,*])+ARRAYSUM(Consumer_Harvest[RIV,
*])+ARRAYSUM(Consumer_Harvest[FLF,*])
Total_Decomposers = ARRAYSUM(Decomposers[*,*])
Total_DOM =
Dead_OM[AMF,NE]+Dead_OM[AMF,CR]+Dead_OM[AMF,PA]+Dead_OM[AMF,FA]+Dead_OM[AM
F,UR]+Dead_OM[SAV,NE]+Dead_OM[SAV,CR]+Dead_OM[SAV,PA]+Dead_OM[SAV,FA]+Dead_O
M[SAV,UR]+Dead_OM[RIV,NE]+Dead_OM[FLF,NE]
Total_Emissions = Emissions_from_Land_Cover_Change+Emissions_from_Land_Use
Total_Emissions_from_Fire = Total_Burned_Biomass/1e9
Total_Emissions_from_Harvest = ARRAYSUM(Emissions_from_Harvest[*,*])
Total_Net_Ecosystem_Production[LandCovers,LandUses] =
Net_Ecosystem_Production_NEP_km2[LandCovers,LandUses]*AmazonLand[LandCovers,LandUses]/1e9
Total_OC_Discharged =
TOM__Spatial_Exchange[AMF,NE]+TOM__Spatial_Exchange[AMF,CR]+TOM__Spatial_Exchange[A
MF,PA]+TOM__Spatial_Exchange[AMF,FA]+TOM__Spatial_Exchange[AMF,UR]+TOM__Spatial_Exc
hange[SAV,NE]+TOM__Spatial_Exchange[SAV,CR]+TOM__Spatial_Exchange[SAV,PA]+TOM__Spati
al_Exchange[SAV,FA]+TOM__Spatial_Exchange[SAV,UR]+TOM__Spatial_Exchange[RIV,NE]+TOM_
_Spatial_Exchange[FLF,NE]
Total_ON_Discharge = Total_OC_Discharged/C:N_Ratio_rivers
Unsat_Depth[LandCovers,LandUses] = IF AmazonLand[LandCovers,LandUses]=0 THEN 0 ELSE
UNSATURATED_WATER[LandCovers,LandUses]/(AmazonLand[LandCovers,LandUses]*1E7)
Waste_LF[LandCovers,LandUses] = 1-MIN(1,WASTE/•Maximum_Waste[LandCovers,LandUses])
Water_LF[LandCovers,LandUses] = Drought[LandCovers,LandUses]*Flood[LandCovers,LandUses]
•Accidental_Fire[LandCovers,LandUses] = Fire_Trigger[LandCovers,LandUses]
•Agricultural_Burning[AMF,NE] = 0
•Agricultural_Burning[AMF,CR] = 1
•Agricultural_Burning[AMF,PA] = 0
•Agricultural_Burning[AMF,FA] = 0

```

- Agricultural_Burning[AMF,UR] = 0
- Agricultural_Burning[SAV,NE] = 0
- Agricultural_Burning[SAV,CR] = 1
- Agricultural_Burning[SAV,PA] = 0
- Agricultural_Burning[SAV,FA] = 0
- Agricultural_Burning[SAV,UR] = 0
- Agricultural_Burning[RIV,NE] = 0
- Agricultural_Burning[RIV,CR] = 0
- Agricultural_Burning[RIV,PA] = 0
- Agricultural_Burning[RIV,FA] = 0
- Agricultural_Burning[RIV,UR] = 0
- Agricultural_Burning[FLF,NE] = 0
- Agricultural_Burning[FLF,CR] = 0
- Agricultural_Burning[FLF,PA] = 0
- Agricultural_Burning[FLF,FA] = 0
- Agricultural_Burning[FLF,UR] = 0
- Autotrophs_Consumption_Rate[AMF,NE] = 0.1
- Autotrophs_Consumption_Rate[AMF,CR] = 0.1
- Autotrophs_Consumption_Rate[AMF,PA] = 0.1
- Autotrophs_Consumption_Rate[AMF,FA] = 0.1
- Autotrophs_Consumption_Rate[AMF,UR] = 0.1
- Autotrophs_Consumption_Rate[SAV,NE] = 0.25
- Autotrophs_Consumption_Rate[SAV,CR] = 0.1
- Autotrophs_Consumption_Rate[SAV,PA] = 0.1
- Autotrophs_Consumption_Rate[SAV,FA] = 0.1
- Autotrophs_Consumption_Rate[SAV,UR] = 0.1
- Autotrophs_Consumption_Rate[RIV,NE] = 0.1
- Autotrophs_Consumption_Rate[RIV,CR] = 0.1
- Autotrophs_Consumption_Rate[RIV,PA] = 0.1
- Autotrophs_Consumption_Rate[RIV,FA] = 0.1
- Autotrophs_Consumption_Rate[RIV,UR] = 0.1
- Autotrophs_Consumption_Rate[FLF,NE] = 0.1
- Autotrophs_Consumption_Rate[FLF,CR] = 0.1
- Autotrophs_Consumption_Rate[FLF,PA] = 0.1
- Autotrophs_Consumption_Rate[FLF,FA] = 0.1
- Autotrophs_Consumption_Rate[FLF,UR] = 0.1
- Autotrophs_Rate[LandCovers,LandUses] = 1
- Autotroph_Mortality_Rate[AMF,NE] = 1
- Autotroph_Mortality_Rate[AMF,CR] = 1
- Autotroph_Mortality_Rate[AMF,PA] = 1
- Autotroph_Mortality_Rate[AMF,FA] = 1
- Autotroph_Mortality_Rate[AMF,UR] = 1
- Autotroph_Mortality_Rate[SAV,NE] = 1
- Autotroph_Mortality_Rate[SAV,CR] = 1
- Autotroph_Mortality_Rate[SAV,PA] = 1
- Autotroph_Mortality_Rate[SAV,FA] = 1
- Autotroph_Mortality_Rate[SAV,UR] = 1
- Autotroph_Mortality_Rate[RIV,NE] = 1
- Autotroph_Mortality_Rate[RIV,CR] = 1
- Autotroph_Mortality_Rate[RIV,PA] = 1
- Autotroph_Mortality_Rate[RIV,FA] = 1
- Autotroph_Mortality_Rate[RIV,UR] = 1
- Autotroph_Mortality_Rate[FLF,NE] = 1
- Autotroph_Mortality_Rate[FLF,CR] = 1
- Autotroph_Mortality_Rate[FLF,PA] = 1
- Autotroph_Mortality_Rate[FLF,FA] = 1

- Autotroph_Mortality_Rate[FLF,UR] = 1
- Autotroph_Respiration_Rate[AMF,NE] = 0.5
- Autotroph_Respiration_Rate[AMF,CR] = 0.08
- Autotroph_Respiration_Rate[AMF,PA] = 0.08
- Autotroph_Respiration_Rate[AMF,FA] = 0.08
- Autotroph_Respiration_Rate[AMF,UR] = 0.08
- Autotroph_Respiration_Rate[SAV,NE] = 0.08
- Autotroph_Respiration_Rate[SAV,CR] = 0.08
- Autotroph_Respiration_Rate[SAV,PA] = 0.08
- Autotroph_Respiration_Rate[SAV,FA] = 0.08
- Autotroph_Respiration_Rate[SAV,UR] = 0.08
- Autotroph_Respiration_Rate[RIV,NE] = 0.08
- Autotroph_Respiration_Rate[RIV,CR] = 0.08
- Autotroph_Respiration_Rate[RIV,PA] = 0.08
- Autotroph_Respiration_Rate[RIV,FA] = 0.08
- Autotroph_Respiration_Rate[RIV,UR] = 0.08
- Autotroph_Respiration_Rate[FLF,NE] = 0.08
- Autotroph_Respiration_Rate[FLF,CR] = 0.08
- Autotroph_Respiration_Rate[FLF,PA] = 0.08
- Autotroph_Respiration_Rate[FLF,FA] = 0.08
- Autotroph_Respiration_Rate[FLF,UR] = 0.08
- Chloro_Conc_Rate[AMF,NE] = 0
- Chloro_Conc_Rate[AMF,CR] = 0.2
- Chloro_Conc_Rate[AMF,PA] = 0.2
- Chloro_Conc_Rate[AMF,FA] = 0.4
- Chloro_Conc_Rate[AMF,UR] = 0.02
- Chloro_Conc_Rate[SAV,NE] = 0.3
- Chloro_Conc_Rate[SAV,CR] = 0.02
- Chloro_Conc_Rate[SAV,PA] = 0.2
- Chloro_Conc_Rate[SAV,FA] = 0.3
- Chloro_Conc_Rate[SAV,UR] = 0.02
- Chloro_Conc_Rate[RIV,NE] = 0.2
- Chloro_Conc_Rate[RIV,CR] = 0
- Chloro_Conc_Rate[RIV,PA] = 0
- Chloro_Conc_Rate[RIV,FA] = 0
- Chloro_Conc_Rate[RIV,UR] = 0
- Chloro_Conc_Rate[FLF,NE] = 0.4
- Chloro_Conc_Rate[FLF,CR] = 0
- Chloro_Conc_Rate[FLF,PA] = 0
- Chloro_Conc_Rate[FLF,FA] = 0
- Chloro_Conc_Rate[FLF,UR] = 0
- Clouds[LandCovers,LandUses] = 0.40
- Consumers_Rate[LandCovers,LandUses] = 0.0001
- Consumer_Mort_Rate[LandCovers,LandUses] = 0.35
- Consumer_Resp_Rate[LandCovers,LandUses] = 0.35
- C_Fraction_Above_Ground_Biomass[LandCovers,LandUses] = 0.45
- C_Fraction_Below_Ground_Biomass[LandCovers,LandUses] = 0.45
- Decomposers_Rate[LandCovers,LandUses] = 0.0004
- Decomposer_Growth_Rate[LandCovers,LandUses] = 0.5
- Decomposer_Mort_Rate[LandCovers,LandUses] = 0.25
- Decomposer_Respiration_Rate[AMF,NE] = 0.15
- Decomposer_Respiration_Rate[AMF,CR] = 0.75
- Decomposer_Respiration_Rate[AMF,PA] = 0.75
- Decomposer_Respiration_Rate[AMF,FA] = 0.5
- Decomposer_Respiration_Rate[AMF,UR] = 0.5
- Decomposer_Respiration_Rate[SAV,NE] = 0.5

- Decomposer_Respiration_Rate[SAV,CR] = 0.5
- Decomposer_Respiration_Rate[SAV,PA] = 0.5
- Decomposer_Respiration_Rate[SAV,FA] = 0.5
- Decomposer_Respiration_Rate[SAV,UR] = 0.5
- Decomposer_Respiration_Rate[RIV,NE] = 0.5
- Decomposer_Respiration_Rate[RIV,CR] = 0.5
- Decomposer_Respiration_Rate[RIV,PA] = 0.5
- Decomposer_Respiration_Rate[RIV,FA] = 0.5
- Decomposer_Respiration_Rate[RIV,UR] = 0.5
- Decomposer_Respiration_Rate[FLF,NE] = 0.5
- Decomposer_Respiration_Rate[FLF,CR] = 0.5
- Decomposer_Respiration_Rate[FLF,PA] = 0.5
- Decomposer_Respiration_Rate[FLF,FA] = 0.5
- Decomposer_Respiration_Rate[FLF,UR] = 0.5
- Decomposing_LF[LandCovers,LandUses] = 1
- Drought_Tolerance[AMF,NE] = 0.05
- Drought_Tolerance[AMF,CR] = 0.30
- Drought_Tolerance[AMF,PA] = 0.30
- Drought_Tolerance[AMF,FA] = 0.6
- Drought_Tolerance[AMF,UR] = 0.2
- Drought_Tolerance[SAV,NE] = 0.7
- Drought_Tolerance[SAV,CR] = 0.31
- Drought_Tolerance[SAV,PA] = 0.30
- Drought_Tolerance[SAV,FA] = 0.30
- Drought_Tolerance[SAV,UR] = 0.20
- Drought_Tolerance[RIV,NE] = 1
- Drought_Tolerance[RIV,CR] = 0
- Drought_Tolerance[RIV,PA] = 0
- Drought_Tolerance[RIV,FA] = 0
- Drought_Tolerance[RIV,UR] = 1
- Drought_Tolerance[FLF,NE] = 0.2
- Drought_Tolerance[FLF,CR] = 0
- Drought_Tolerance[FLF,PA] = 0
- Drought_Tolerance[FLF,FA] = 0
- Drought_Tolerance[FLF,UR] = 1
- Ease_of_Autotroph_Harvest[LandCovers,LandUses] = 0.35
- Ease_of_consumer_harvest[LandCovers,LandUses] = 0.001
- EC_Coeff_Autotr[LandCovers,LandUses] = 0.1
- EC__coeff_medium[LandCovers,LandUses] = 0.0007
- Fallow_Burning[AMF,NE] = 0
- Fallow_Burning[AMF,CR] = 0
- Fallow_Burning[AMF,PA] = 0
- Fallow_Burning[AMF,FA] = 1
- Fallow_Burning[AMF,UR] = 0
- Fallow_Burning[SAV,NE] = 0
- Fallow_Burning[SAV,CR] = 0
- Fallow_Burning[SAV,PA] = 0
- Fallow_Burning[SAV,FA] = 1
- Fallow_Burning[SAV,UR] = 0
- Fallow_Burning[RIV,NE] = 0
- Fallow_Burning[RIV,CR] = 0
- Fallow_Burning[RIV,PA] = 0
- Fallow_Burning[RIV,FA] = 0
- Fallow_Burning[RIV,UR] = 0
- Fallow_Burning[FLF,NE] = 0
- Fallow_Burning[FLF,CR] = 0

- Fallow_Burning[FLF,PA] = 0
- Fallow_Burning[FLF,FA] = 0
- Fallow_Burning[FLF,UR] = 0
- Flood_tolerance[AMF,NE] = 0.4
- Flood_tolerance[AMF,CR] = 0.30
- Flood_tolerance[AMF,PA] = 0.30
- Flood_tolerance[AMF,FA] = 0.7
- Flood_tolerance[AMF,UR] = 0.2
- Flood_tolerance[SAV,NE] = 0.5
- Flood_tolerance[SAV,CR] = 0.3
- Flood_tolerance[SAV,PA] = 0.3
- Flood_tolerance[SAV,FA] = 0.6
- Flood_tolerance[SAV,UR] = 0.2
- Flood_tolerance[RIV,NE] = 1
- Flood_tolerance[RIV,CR] = 0.3
- Flood_tolerance[RIV,PA] = 0.3
- Flood_tolerance[RIV,FA] = 0.3
- Flood_tolerance[RIV,UR] = 0.3
- Flood_tolerance[FLF,NE] = 0.80
- Flood_tolerance[FLF,CR] = 0
- Flood_tolerance[FLF,PA] = 0
- Flood_tolerance[FLF,FA] = 0
- Flood_tolerance[FLF,UR] = 0
- Forest_Burning[AMF,NE] = 1
- Forest_Burning[AMF,CR] = 0
- Forest_Burning[AMF,PA] = 0
- Forest_Burning[AMF,FA] = 0
- Forest_Burning[AMF,UR] = 0
- Forest_Burning[SAV,NE] = 0
- Forest_Burning[SAV,CR] = 0
- Forest_Burning[SAV,PA] = 0
- Forest_Burning[SAV,FA] = 0
- Forest_Burning[SAV,UR] = 0
- Forest_Burning[RIV,NE] = 0
- Forest_Burning[RIV,CR] = 0
- Forest_Burning[RIV,PA] = 0
- Forest_Burning[RIV,FA] = 0
- Forest_Burning[RIV,UR] = 0
- Forest_Burning[FLF,NE] = 0
- Forest_Burning[FLF,CR] = 0
- Forest_Burning[FLF,PA] = 0
- Forest_Burning[FLF,FA] = 0
- Forest_Burning[FLF,UR] = 0
- Light_Depth[AMF,NE] = 15
- Light_Depth[AMF,CR] = 1
- Light_Depth[AMF,PA] = 0.5
- Light_Depth[AMF,FA] = 7
- Light_Depth[AMF,UR] = 0.1
- Light_Depth[SAV,NE] = 10
- Light_Depth[SAV,CR] = 1
- Light_Depth[SAV,PA] = 0.5
- Light_Depth[SAV,FA] = 7
- Light_Depth[SAV,UR] = 0.1
- Light_Depth[RIV,NE] = 15
- Light_Depth[RIV,CR] = 15
- Light_Depth[RIV,PA] = 15

- Light_Depth[RIV,FA] = 15
- Light_Depth[RIV,UR] = 15
- Light_Depth[FLF,NE] = 15
- Light_Depth[FLF,CR] = 15
- Light_Depth[FLF,PA] = 15
- Light_Depth[FLF,FA] = 15
- Light_Depth[FLF,UR] = 15
- Maximum_Waste[LandCovers,LandUses] = 6000
- Max_C[LandCovers,LandUses] = 700
- Max_Carbon_Fixation_Rate[AMF,NE] = 3
- Max_Carbon_Fixation_Rate[AMF,CR] = 1
- Max_Carbon_Fixation_Rate[AMF,PA] = 1
- Max_Carbon_Fixation_Rate[AMF,FA] = 10
- Max_Carbon_Fixation_Rate[AMF,UR] = 1
- Max_Carbon_Fixation_Rate[SAV,NE] = 2
- Max_Carbon_Fixation_Rate[SAV,CR] = 2
- Max_Carbon_Fixation_Rate[SAV,PA] = 2
- Max_Carbon_Fixation_Rate[SAV,FA] = 7
- Max_Carbon_Fixation_Rate[SAV,UR] = 1
- Max_Carbon_Fixation_Rate[RIV,NE] = 1
- Max_Carbon_Fixation_Rate[RIV,CR] = 0
- Max_Carbon_Fixation_Rate[RIV,PA] = 0
- Max_Carbon_Fixation_Rate[RIV,FA] = 0
- Max_Carbon_Fixation_Rate[RIV,UR] = 0
- Max_Carbon_Fixation_Rate[FLF,NE] = 2
- Max_Carbon_Fixation_Rate[FLF,CR] = 0
- Max_Carbon_Fixation_Rate[FLF,PA] = 0
- Max_Carbon_Fixation_Rate[FLF,FA] = 0
- Max_Carbon_Fixation_Rate[FLF,UR] = 0
- Max_Light[LandCovers,LandUses] = 950*12
- Min_C[LandCovers,LandUses] = 330.75
- Min_Light[LandCovers,LandUses] = 182.5*12
- N_Fraction_Above_Ground_Biomass[LandCovers,LandUses] = 0.6/100
- N_Fraction_Below_Ground_Biomass[LandCovers,LandUses] = 1.25/100
- Opt_C[LandCovers,LandUses] = 700
- Opt_Light[LandCovers,LandUses] = 400*12
- Pasture_Burning[AMF,NE] = 0
- Pasture_Burning[AMF,CR] = 0
- Pasture_Burning[AMF,PA] = 1
- Pasture_Burning[AMF,FA] = 0
- Pasture_Burning[AMF,UR] = 0
- Pasture_Burning[SAV,NE] = 0
- Pasture_Burning[SAV,CR] = 0
- Pasture_Burning[SAV,PA] = 1
- Pasture_Burning[SAV,FA] = 0
- Pasture_Burning[SAV,UR] = 0
- Pasture_Burning[RIV,NE] = 0
- Pasture_Burning[RIV,CR] = 0
- Pasture_Burning[RIV,PA] = 0
- Pasture_Burning[RIV,FA] = 0
- Pasture_Burning[RIV,UR] = 0
- Pasture_Burning[FLF,NE] = 0
- Pasture_Burning[FLF,CR] = 0
- Pasture_Burning[FLF,PA] = 0
- Pasture_Burning[FLF,FA] = 0
- Pasture_Burning[FLF,UR] = 0

- Rate_of_Soil__Humus_Formation[LandCovers,LandUses] = 0.25
- Savanna_Burning[AMF,NE] = 0
- Savanna_Burning[AMF,CR] = 0
- Savanna_Burning[AMF,PA] = 0
- Savanna_Burning[AMF,FA] = 0
- Savanna_Burning[AMF,UR] = 0
- Savanna_Burning[SAV,NE] = 1
- Savanna_Burning[SAV,CR] = 0
- Savanna_Burning[SAV,PA] = 0
- Savanna_Burning[SAV,FA] = 0
- Savanna_Burning[SAV,UR] = 0
- Savanna_Burning[RIV,NE] = 0
- Savanna_Burning[RIV,CR] = 0
- Savanna_Burning[RIV,PA] = 0
- Savanna_Burning[RIV,FA] = 0
- Savanna_Burning[RIV,UR] = 0
- Savanna_Burning[FLF,NE] = 0
- Savanna_Burning[FLF,CR] = 0
- Savanna_Burning[FLF,PA] = 0
- Savanna_Burning[FLF,FA] = 0
- Savanna_Burning[FLF,UR] = 0
- TOM_Spatial_Redistr_Rate[LandCovers,LandUses] = 0.01
- T_Max[LandCovers,LandUses] = 25
- T_Min[LandCovers,LandUses] = 20
- T_Opt[LandCovers,LandUses] = 25
- Water_Temp[LandCovers,LandUses] = 18

Timber_Extraction_Data = GRAPH(TIME)
(1980, 11.7), (1985, 23.9), (1990, 46.3), (1995, 52.3), (2000, 15.7)

ChangeWithinSectorLanduseForest

AMF_CR(t) = AMF_CR(t - dt) + (LUC__AMF_NE_to_AMF_CR - LUC_AMF__CR_to_AMF_UR -
LUC_AMF_CR_to_AMF_PA - LUC_AMF_CR_to_AMF_FA) * dt
INIT AMF_CR = IC_LCLU[AMF,CR]

INFLOWS:

LUC__AMF_NE_to_AMF_CR = (LCCR_AMF[NE,CR]*LCOut_AMF[AMF,NE]*(1-
(•Equil_Low_AMF[AMF,NE]/LCOut_AMF[AMF,NE])))

OUTFLOWS:

LUC_AMF__CR_to_AMF_UR = LCCR_AMF[CR,UR]*LCOut_AMF[AMF,CR]*(1-
(•Equil_Low_AMF[AMF,CR]/LCOut_AMF[AMF,CR]))

LUC_AMF_CR_to_AMF_PA = MAX(0,LCOut_AMF[AMF,CR]*RT_AMF_CR_to_AMF_PA*(1-
(•Equil_Low_AMF[AMF,CR]/LCOut_AMF[AMF,CR])))+MIN(0,LCOut_AMF[AMF,PA]*RT_AMF_CR
_to_AMF_PA*(1-(•Equil_Low_AMF[AMF,PA]/LCOut_AMF[AMF,PA])))

LUC_AMF_CR_to_AMF_FA = MAX(0,LCOut_AMF[AMF,CR]*RT_AMF_AG_to_AMF_FA*(1-
(•Equil_Low_AMF[AMF,CR]/LCOut_AMF[AMF,CR])))+MIN(0,LCOut_AMF[AMF,FA]*RT_AMF_AG
_to_AMF_FA*(1-(•Equil_Low_AMF[AMF,FA]/LCOut_AMF[AMF,FA])))

AMF_FA(t) = AMF_FA(t - dt) + (LUC_AMF_CR_to_AMF_FA + LUC_AMF_PA_to_AMF_FA -
LUC_AMF_FA_to_AMF_NE - LUC_AMF_FA_to_AMF_UR) * dt

INIT AMF_FA = IC_LCLU[AMF,FA]

INFLOWS:

LUC_AMF_CR_to_AMF_FA = MAX(0,LCOut_AMF[AMF,CR]*RT_AMF_AG_to_AMF_FA*(1-
(•Equil_Low_AMF[AMF,CR]/LCOut_AMF[AMF,CR])))+MIN(0,LCOut_AMF[AMF,FA]*RT_AMF_AG
_to_AMF_FA*(1-(•Equil_Low_AMF[AMF,FA]/LCOut_AMF[AMF,FA])))

$LUC_AMF_PA_to_AMF_FA = (MAX(0,LCOut_AMF[AMF,PA]*RT_AMF_PA_to_AMF_FA*(1- (•Equil_Low_AMF[AMF,PA]/LCOut_AMF[AMF,PA]))) + MIN(0,LCOut_AMF[AMF,FA]*RT_AMF_PA_to_AMF_FA*(1-(•Equil_Low_AMF[AMF,FA]/LCOut_AMF[AMF,FA])))$

OUTFLOWS:

$LUC_AMF_FA_to_AMF_NE = LCCR_AMF[FA,NE]*LCOut_AMF[AMF,FA]*(1-(•Equil_Low_AMF[AMF,FA]/LCOut_AMF[AMF,FA]))$

$LUC_AMF_FA_to_AMF_UR = (LCCR_AMF[FA,UR]*LCOut_AMF[AMF,FA]*(1-(•Equil_Low_AMF[AMF,FA])))$

$AMF_NE(t) = AMF_NE(t - dt) + (LUC_AMF_FA_to_AMF_NE - LUC_AMF_NE_to_AMF_URB - LUC_AMF_NE_to_AMF_PA - LUC_AMF_NE_to_AMF_CR) * dt$

INIT AMF_NE = IC_LCLU[AMF,NE]

INFLOWS:

$LUC_AMF_FA_to_AMF_NE = LCCR_AMF[FA,NE]*LCOut_AMF[AMF,FA]*(1-(•Equil_Low_AMF[AMF,FA]/LCOut_AMF[AMF,FA]))$

OUTFLOWS:

$LUC_AMF_NE_to_AMF_URB = LCCR_AMF[NE,UR]*LCOut_AMF[AMF,NE]*(1-(•Equil_Low_AMF[AMF,NE]/LCOut_AMF[AMF,NE]))$

$LUC_AMF_NE_to_AMF_PA = LCCR_AMF[NE,PA]*LCOut_AMF[AMF,NE]*(1-(•Equil_Low_AMF[AMF,NE]/LCOut_AMF[AMF,NE]))$

$LUC_AMF_NE_to_AMF_CR = (LCCR_AMF[NE,CR]*LCOut_AMF[AMF,NE]*(1-(•Equil_Low_AMF[AMF,NE]/LCOut_AMF[AMF,NE])))$

$AMF_PA(t) = AMF_PA(t - dt) + (LUC_AMF_NE_to_AMF_PA + LUC_AMF_CR_to_AMF_PA - LUC_AMF_PA_to_AMF_UR - LUC_AMF_PA_to_AMF_FA) * dt$

INIT AMF_PA = IC_LCLU[AMF,PA]

INFLOWS:

$LUC_AMF_NE_to_AMF_PA = LCCR_AMF[NE,PA]*LCOut_AMF[AMF,NE]*(1-(•Equil_Low_AMF[AMF,NE]/LCOut_AMF[AMF,NE]))$

$LUC_AMF_CR_to_AMF_PA = MAX(0,LCOut_AMF[AMF,CR]*RT_AMF_CR_to_AMF_PA*(1-(•Equil_Low_AMF[AMF,CR]/LCOut_AMF[AMF,CR]))) + MIN(0,LCOut_AMF[AMF,PA]*RT_AMF_CR_to_AMF_PA*(1-(•Equil_Low_AMF[AMF,PA]/LCOut_AMF[AMF,PA])))$

OUTFLOWS:

$LUC_AMF_PA_to_AMF_UR = LCCR_AMF[PA,UR]*LCOut_AMF[AMF,PA]*(1-(•Equil_Low_AMF[AMF,PA]/LCOut_AMF[AMF,PA]))$

$LUC_AMF_PA_to_AMF_FA = (MAX(0,LCOut_AMF[AMF,PA]*RT_AMF_PA_to_AMF_FA*(1-(•Equil_Low_AMF[AMF,PA]/LCOut_AMF[AMF,PA]))) + MIN(0,LCOut_AMF[AMF,FA]*RT_AMF_PA_to_AMF_FA*(1-(•Equil_Low_AMF[AMF,FA]/LCOut_AMF[AMF,FA])))$

$AMF_UR(t) = AMF_UR(t - dt) + (LUC_AMF_CR_to_AMF_UR + LUC_AMF_PA_to_AMF_UR + LUC_AMF_NE_to_AMF_URB + LUC_AMF_FA_to_AMF_UR) * dt$

INIT AMF_UR = IC_LCLU[AMF,UR]

INFLOWS:

$LUC_AMF_CR_to_AMF_UR = LCCR_AMF[CR,UR]*LCOut_AMF[AMF,CR]*(1-(•Equil_Low_AMF[AMF,CR]/LCOut_AMF[AMF,CR]))$

$LUC_AMF_PA_to_AMF_UR = LCCR_AMF[PA,UR]*LCOut_AMF[AMF,PA]*(1-(•Equil_Low_AMF[AMF,PA]/LCOut_AMF[AMF,PA]))$

$LUC_AMF_NE_to_AMF_URB = LCCR_AMF[NE,UR]*LCOut_AMF[AMF,NE]*(1-(•Equil_Low_AMF[AMF,NE]/LCOut_AMF[AMF,NE]))$

$LUC_AMF_FA_to_AMF_UR = (LCCR_AMF[FA,UR]*LCOut_AMF[AMF,FA]*(1-(•Equil_Low_AMF[AMF,FA])))$

F&L(t) = F&L(t - dt)

INIT F&L = IC_LCLU[FLF,NE]

Rivers(t) = Rivers(t - dt)

INIT Rivers = IC_LCLU[RIV,NE]

AmazonLand[AMF,NE] =
 AMF_NE+0*(AMF_NE+AMF_CR+AMF_FA+AMF_PA+AMF_UR+Rivers+SAV_NE+SAV_CR+SAV_ FA+SAV_PA+SAV_UR+F&L)
 AmazonLand[AMF,CR] =
 AMF_CR+0*(AMF_NE+AMF_CR+AMF_FA+AMF_PA+AMF_UR+Rivers+SAV_NE+SAV_CR+SAV_ FA+SAV_PA+SAV_UR+F&L)
 AmazonLand[AMF,PA] =
 AMF_PA+0*(AMF_NE+AMF_CR+AMF_FA+AMF_PA+AMF_UR+Rivers+SAV_NE+SAV_CR+SAV_ FA+SAV_PA+SAV_UR+F&L)
 AmazonLand[AMF,FA] =
 AMF_FA+0*(AMF_NE+AMF_CR+AMF_FA+AMF_PA+AMF_UR+Rivers+SAV_NE+SAV_CR+SAV_ FA+SAV_PA+SAV_UR+F&L)
 AmazonLand[AMF,UR] =
 AMF_UR+0*(AMF_NE+AMF_CR+AMF_FA+AMF_PA+AMF_UR+Rivers+SAV_NE+SAV_CR+SAV_ FA+SAV_PA+SAV_UR+F&L)
 AmazonLand[SAV,NE] =
 SAV_NE+0*(AMF_NE+AMF_CR+AMF_FA+AMF_PA+AMF_UR+Rivers+SAV_NE+SAV_CR+SAV_ FA+SAV_PA+SAV_UR+F&L)
 AmazonLand[SAV,CR] =
 SAV_CR+0*(AMF_NE+AMF_CR+AMF_FA+AMF_PA+AMF_UR+Rivers+SAV_NE+SAV_CR+SAV_ FA+SAV_PA+SAV_UR+F&L)
 AmazonLand[SAV,PA] =
 SAV_PA+0*(AMF_NE+AMF_CR+AMF_FA+AMF_PA+AMF_UR+Rivers+SAV_NE+SAV_CR+SAV_ FA+SAV_PA+SAV_UR+F&L)
 AmazonLand[SAV,FA] =
 SAV_FA+0*(AMF_NE+AMF_CR+AMF_FA+AMF_PA+AMF_UR+Rivers+SAV_NE+SAV_CR+SAV_ FA+SAV_PA+SAV_UR+F&L)
 AmazonLand[SAV,UR] =
 SAV_UR+0*(AMF_NE+AMF_CR+AMF_FA+AMF_PA+AMF_UR+Rivers+SAV_NE+SAV_CR+SAV_ FA+SAV_PA+SAV_UR+F&L)
 AmazonLand[RIV,NE] =
 Rivers+0*(AMF_NE+AMF_CR+AMF_FA+AMF_PA+AMF_UR+Rivers+SAV_NE+SAV_CR+SAV_ FA+SAV_PA+SAV_UR+F&L)
 AmazonLand[RIV,CR] =
 0*(AMF_NE+AMF_CR+AMF_FA+AMF_PA+AMF_UR+Rivers+SAV_NE+SAV_CR+SAV_ FA+SAV_ PA+SAV_UR+F&L)
 AmazonLand[RIV,PA] =
 0*(AMF_NE+AMF_CR+AMF_FA+AMF_PA+AMF_UR+Rivers+SAV_NE+SAV_CR+SAV_ FA+SAV_ PA+SAV_UR+F&L)
 AmazonLand[RIV,FA] =
 0*(AMF_NE+AMF_CR+AMF_FA+AMF_PA+AMF_UR+Rivers+SAV_NE+SAV_CR+SAV_ FA+SAV_ PA+SAV_UR+F&L)
 AmazonLand[RIV,UR] =
 0*(AMF_NE+AMF_CR+AMF_FA+AMF_PA+AMF_UR+Rivers+SAV_NE+SAV_CR+SAV_ FA+SAV_ PA+SAV_UR+F&L)
 AmazonLand[FLF,NE] =
 F&L+0*(AMF_NE+AMF_CR+AMF_FA+AMF_PA+AMF_UR+Rivers+SAV_NE+SAV_CR+SAV_ FA+ SAV_PA+SAV_UR+F&L)
 AmazonLand[FLF,CR] =
 0*(AMF_NE+AMF_CR+AMF_FA+AMF_PA+AMF_UR+Rivers+SAV_NE+SAV_CR+SAV_ FA+SAV_ PA+SAV_UR+F&L)
 AmazonLand[FLF,PA] =
 0*(AMF_NE+AMF_CR+AMF_FA+AMF_PA+AMF_UR+Rivers+SAV_NE+SAV_CR+SAV_ FA+SAV_ PA+SAV_UR+F&L)

Annual_Deforestation[FLF,CR] =
 0*(LUC__AMF_NE_to_AMF_CR+LUC_AMF_NE_to_AMF_PA+LUC_AMF_NE_to_AMF_URB)+0*(
 LUC_SAV_NE_to_SAV_CR+LUC_SAV_NE_to_SAV_PA+LUC_SAV_NE_to_SAV_UR)
 Annual_Deforestation[FLF,PA] =
 0*(LUC__AMF_NE_to_AMF_CR+LUC_AMF_NE_to_AMF_PA+LUC_AMF_NE_to_AMF_URB)+0*(
 LUC_SAV_NE_to_SAV_CR+LUC_SAV_NE_to_SAV_PA+LUC_SAV_NE_to_SAV_UR)
 Annual_Deforestation[FLF,FA] =
 0*(LUC__AMF_NE_to_AMF_CR+LUC_AMF_NE_to_AMF_PA+LUC_AMF_NE_to_AMF_URB)+0*(
 LUC_SAV_NE_to_SAV_CR+LUC_SAV_NE_to_SAV_PA+LUC_SAV_NE_to_SAV_UR)
 Annual_Deforestation[FLF,UR] =
 0*(LUC__AMF_NE_to_AMF_CR+LUC_AMF_NE_to_AMF_PA+LUC_AMF_NE_to_AMF_URB)+0*(
 LUC_SAV_NE_to_SAV_CR+LUC_SAV_NE_to_SAV_PA+LUC_SAV_NE_to_SAV_UR)
 Annual_Def_Forest = Annual_Deforestation[AMF,NE]
 Annual_Def_Savanna = Annual_Deforestation[SAV,NE]
 Brazilian_Legal_Amazon = 5032925
 F_Cleared_Area[LandCovers,LandUses] =
 AmazonLand[AMF,CR]+AmazonLand[AMF,PA]+AmazonLand[AMF,FA]+AmazonLand[AMF,UR]
 IC_LCLU[AMF,NE] = 1
 IC_LCLU[AMF,CR] = 1
 IC_LCLU[AMF,PA] = 1
 IC_LCLU[AMF,FA] = 1
 IC_LCLU[AMF,UR] = 1
 IC_LCLU[SAV,NE] = 1
 IC_LCLU[SAV,CR] = 1
 IC_LCLU[SAV,PA] = 1
 IC_LCLU[SAV,FA] = 1
 IC_LCLU[SAV,UR] = 1
 IC_LCLU[RIV,NE] = 1
 IC_LCLU[RIV,CR] = 0
 IC_LCLU[RIV,PA] = 0
 IC_LCLU[RIV,FA] = 0
 IC_LCLU[RIV,UR] = 0
 IC_LCLU[FLF,NE] = 1
 IC_LCLU[FLF,CR] = 0
 IC_LCLU[FLF,PA] = 0
 IC_LCLU[FLF,FA] = 0
 IC_LCLU[FLF,UR] = 0
 Initial_LCLU_and_Checking_with_Legal_Amazon =
 (IC_LCLU[AMF,NE]+IC_LCLU[AMF,CR]+IC_LCLU[AMF,PA]+IC_LCLU[AMF,FA]+IC_LCLU[AM
 F,UR]+IC_LCLU[SAV,NE]+IC_LCLU[SAV,CR]+IC_LCLU[SAV,PA]+IC_LCLU[SAV,FA]+IC_LCLU[
 SAV,UR]+IC_LCLU[RIV,NE]+IC_LCLU[FLF,NE])-Brazilian_Legal_Amazon
 LandCover[AMF] =
 AmazonLand[AMF,NE]+AmazonLand[AMF,CR]+AmazonLand[AMF,PA]+AmazonLand[AMF,FA]+Am
 azonLand[AMF,UR]
 LandCover[SAV] =
 AmazonLand[SAV,NE]+AmazonLand[SAV,CR]+AmazonLand[SAV,PA]+AmazonLand[SAV,FA]+Ama
 azonLand[SAV,UR]
 LandCover[RIV] = AmazonLand[RIV,NE]
 LandCover[FLF] = AmazonLand[FLF,NE]
 LandUse[NE] =
 AmazonLand[AMF,NE]+AmazonLand[SAV,NE]+AmazonLand[RIV,NE]+AmazonLand[FLF,NE]
 LandUse[CR] = AmazonLand[AMF,CR]+AmazonLand[SAV,CR]
 LandUse[PA] = AmazonLand[AMF,PA]+AmazonLand[SAV,PA]
 LandUse[FA] = AmazonLand[AMF,FA]+AmazonLand[SAV,FA]
 LandUse[UR] = AmazonLand[AMF,UR]+AmazonLand[SAV,UR]
 LCOutSAV[LandCovers,LandUses] = AmazonLand[SAV, LandUses]

$LCOut_AMF[LandCovers, LandUses] = AmazonLand[AMF, LandUses]$
 $RT_AMF_AG_to_AMF_FA = LCCR_AMF[CR, FA] * (1 - (LCOut_AMF[AMF, CR] / MAX(LCOut_AMF[AMF, CR], Equil_High_AMF[AMF, CR]))) - LCCR_AMF[FA, CR] * (1 - (LCOut_AMF[AMF, FA] / Max(LCOut_AMF[AMF, FA], Equil_High_AMF[AMF, FA])))$
 $RT_AMF_CR_to_AMF_PA = LCCR_AMF[NE, PA] * (1 - (LCOut_AMF[AMF, NE] / MAX(LCOut_AMF[AMF, NE], Equil_High_AMF[AMF, NE]))) - LCCR_AMF[PA, NE] * (1 - (LCOut_AMF[AMF, PA] / Max(LCOut_AMF[AMF, PA], Equil_High_AMF[AMF, PA])))$
 $RT_AMF_PA_to_AMF_FA = LCCR_AMF[PA, FA] * (1 - (LCOut_AMF[AMF, PA] / MAX(LCOut_AMF[AMF, PA], Equil_High_AMF[AMF, PA]))) - LCCR_AMF[FA, PA] * (1 - (LCOut_AMF[AMF, FA] / Max(LCOut_AMF[AMF, FA], Equil_High_AMF[AMF, FA])))$
 $S_Cleared_Area[LandCovers, LandUses] = AmazonLand[SAV, CR] + AmazonLand[SAV, PA] + AmazonLand[SAV, FA] + AmazonLand[SAV, UR]$
 $Total_Amazon_Land = AmazonLand[AMF, NE] + AmazonLand[AMF, CR] + AmazonLand[AMF, PA] + AmazonLand[AMF, FA] + AmazonLand[AMF, UR] + AmazonLand[SAV, NE] + AmazonLand[SAV, CR] + AmazonLand[SAV, PA] + AmazonLand[SAV, FA] + AmazonLand[SAV, UR] + AmazonLand[RIV, NE] + AmazonLand[FLF, NE]$
 $TOTAL_ANNUAL_DEFORESTATION = Annual_Def_Savanna + Annual_Def_Forest$
 $Total_Cleared_Area = AmazonLand[AMF, CR] + AmazonLand[AMF, PA] + AmazonLand[AMF, FA] + AmazonLand[AMF, UR] + AmazonLand[SAV, CR] + AmazonLand[SAV, PA] + AmazonLand[SAV, FA] + AmazonLand[SAV, UR]$
 $TOTAL_LCLU = LandCover[AMF] + LandCover[SAV] + LandCover[RIV] + LandCover[FLF]$
 $TOTAL_LU = LandUse[NE] + LandUse[CR] + LandUse[PA] + LandUse[FA] + LandUse[UR]$

- Equil_High_AMF[AMF, NE] = 1
- Equil_High_AMF[AMF, CR] = 1
- Equil_High_AMF[AMF, PA] = 1
- Equil_High_AMF[AMF, FA] = 1
- Equil_High_AMF[AMF, UR] = 1
- Equil_High_AMF[SAV, NE] = 0
- Equil_High_AMF[SAV, CR] = 0
- Equil_High_AMF[SAV, PA] = 0
- Equil_High_AMF[SAV, FA] = 0
- Equil_High_AMF[SAV, UR] = 0
- Equil_High_AMF[RIV, NE] = 0
- Equil_High_AMF[RIV, CR] = 0
- Equil_High_AMF[RIV, PA] = 0
- Equil_High_AMF[RIV, FA] = 0
- Equil_High_AMF[RIV, UR] = 0
- Equil_High_AMF[FLF, NE] = 0
- Equil_High_AMF[FLF, CR] = 0
- Equil_High_AMF[FLF, PA] = 0
- Equil_High_AMF[FLF, FA] = 0
- Equil_High_AMF[FLF, UR] = 0
- Equil_Low_AMF[AMF, NE] = 1
- Equil_Low_AMF[AMF, CR] = 1
- Equil_Low_AMF[AMF, PA] = 1
- Equil_Low_AMF[AMF, FA] = 1
- Equil_Low_AMF[AMF, UR] = 1
- Equil_Low_AMF[SAV, NE] = 0
- Equil_Low_AMF[SAV, CR] = 0
- Equil_Low_AMF[SAV, PA] = 0
- Equil_Low_AMF[SAV, FA] = 0
- Equil_Low_AMF[SAV, UR] = 0
- Equil_Low_AMF[RIV, NE] = 0

- Equil_Low_AMF[RIV,CR] = 0
- Equil_Low_AMF[RIV,PA] = 0
- Equil_Low_AMF[RIV,FA] = 0
- Equil_Low_AMF[RIV,UR] = 0
- Equil_Low_AMF[FLF,NE] = 0
- Equil_Low_AMF[FLF,CR] = 0
- Equil_Low_AMF[FLF,PA] = 0
- Equil_Low_AMF[FLF,FA] = 0
- Equil_Low_AMF[FLF,UR] = 0

ChangeWithinSectorLanduseSavanna

SAV_CR(t) = SAV_CR(t - dt) + (LUC_SAV_NE_to_SAV_CR + LUC_SAV_FA_to_SAV_CR -
LUC_SAV_CR_to_SAV_UR - LUC_SAV_CR_to_SAV_PA) * dt
INIT SAV_CR = IC_LCLU[SAV,CR]

INFLOWS:

LUC_SAV_NE_to_SAV_CR = Land_Cover_SAV_Conversion_Rt[NE,CR]*LCOutSAV[SAV,NE]*(1-
(•Equil_Low_S[SAV,NE]/LCOutSAV[SAV,NE]))
LUC_SAV_FA_to_SAV_CR = MAX(0,LCOutSAV[SAV,CR]*RT_SAV_FA_to_SAV_AG*(1-
(•Equil_Low_S[SAV,CR]/LCOutSAV[SAV,CR])))+MIN(0,LCOutSAV[SAV,FA]*RT_SAV_FA_to_SAV
_AG*(1-(•Equil_Low_S[SAV,FA]/LCOutSAV[SAV,FA])))

OUTFLOWS:

LUC_SAV_CR_to_SAV_UR = Land_Cover_SAV_Conversion_Rt[CR,UR]*LCOutSAV[SAV,CR]*(1-
(•Equil_Low_S[SAV,CR]/LCOutSAV[SAV,CR]))
LUC_SAV_CR_to_SAV_PA = MAX(0,LCOutSAV[SAV,CR]*RT_SAV_CR_to_SAV_PA*(1-
(•Equil_Low_S[SAV,CR]/LCOutSAV[SAV,CR])))+MIN(0,LCOutSAV[SAV,PA]*RT_SAV_CR_to_SA
V_PA*(1-(•Equil_Low_S[SAV,PA]/LCOutSAV[SAV,PA]))
SAV_FA(t) = SAV_FA(t - dt) + (LUC_SAV_PA_to_SAV_FA - LUC_SAV_FA_to_SAV_UR -
LUC_SAV_FA_to_SAV_NE - LUC_SAV_FA_to_SAV_CR) * dt
INIT SAV_FA = IC_LCLU[SAV,FA]

INFLOWS:

LUC_SAV_PA_to_SAV_FA = (MAX(0,LCOutSAV[SAV,PA]*RT_SAV_PA_to_SAV_FA*(1-
(•Equil_Low_S[SAV,PA]/LCOutSAV[SAV,PA])))+MIN(0,LCOutSAV[SAV,FA]*RT_SAV_PA_to_SAV
_FA*(1-(•Equil_Low_S[SAV,FA]/LCOutSAV[SAV,FA]))))

OUTFLOWS:

LUC_SAV_FA_to_SAV_UR = Land_Cover_SAV_Conversion_Rt[FA,UR]*LCOutSAV[SAV,FA]*(1-
(•Equil_Low_S[SAV,FA]/LCOutSAV[SAV,FA]))
LUC_SAV_FA_to_SAV_NE = (Land_Cover_SAV_Conversion_Rt[FA,NE]*LCOutSAV[SAV,FA]*(1-
(•Equil_Low_S[SAV,FA]/LCOutSAV[SAV,FA]))
LUC_SAV_FA_to_SAV_CR = MAX(0,LCOutSAV[SAV,CR]*RT_SAV_FA_to_SAV_AG*(1-
(•Equil_Low_S[SAV,CR]/LCOutSAV[SAV,CR])))+MIN(0,LCOutSAV[SAV,FA]*RT_SAV_FA_to_SAV
_AG*(1-(•Equil_Low_S[SAV,FA]/LCOutSAV[SAV,FA]))
SAV_NE(t) = SAV_NE(t - dt) + (LUC_SAV_FA_to_SAV_NE - LUC_SAV_NE_to_SAV_UR -
LUC_SAV_NE_to_SAV_PA - LUC_SAV_NE_to_SAV_CR) * dt
INIT SAV_NE = IC_LCLU[SAV,NE]

INFLOWS:

LUC_SAV_FA_to_SAV_NE = (Land_Cover_SAV_Conversion_Rt[FA,NE]*LCOutSAV[SAV,FA]*(1-
(•Equil_Low_S[SAV,FA]/LCOutSAV[SAV,FA]))

OUTFLOWS:

LUC_SAV_NE_to_SAV_UR = Land_Cover_SAV_Conversion_Rt[NE,UR]*LCOutSAV[SAV,NE]*(1-
(•Equil_Low_S[SAV,NE]/LCOutSAV[SAV,NE]))
LUC_SAV_NE_to_SAV_PA = Land_Cover_SAV_Conversion_Rt[NE,PA]*LCOutSAV[SAV,NE]*(1-
(•Equil_Low_S[SAV,NE]/LCOutSAV[SAV,NE]))

$LUC_SAV_NE_to_SAV_CR = Land_Cover_SAV_Conversion_Rt[NE,CR]*LCOutSAV[SAV,NE]*(1-$
 $(\bullet Equil_Low_S[SAV,NE]/LCOutSAV[SAV,NE]))$
 $SAV_PA(t) = SAV_PA(t - dt) + (LUC_SAV_NE_to_SAV_PA + LUC_SAV_CR_to_SAV_PA -$
 $LUC_SAV_PA_to_SAV_UR - LUC_SAV_PA_to_SAV_FA) * dt$
 $INIT SAV_PA = IC_LCLU[SAV,PA]$

INFLOWS:

$LUC_SAV_NE_to_SAV_PA = Land_Cover_SAV_Conversion_Rt[NE,PA]*LCOutSAV[SAV,NE]*(1-$
 $(\bullet Equil_Low_S[SAV,NE]/LCOutSAV[SAV,NE]))$
 $LUC_SAV_CR_to_SAV_PA = MAX(0,LCOutSAV[SAV,CR]*RT_SAV_CR_to_SAV_PA*(1-$
 $(\bullet Equil_Low_S[SAV,CR]/LCOutSAV[SAV,CR])))+MIN(0,LCOutSAV[SAV,PA]*RT_SAV_CR_to_SA$
 $V_PA*(1-(\bullet Equil_Low_S[SAV,PA]/LCOutSAV[SAV,PA])))$

OUTFLOWS:

$LUC_SAV_PA_to_SAV_UR = Land_Cover_SAV_Conversion_Rt[PA,UR]*LCOutSAV[SAV,PA]*(1-$
 $(\bullet Equil_Low_S[SAV,PA]/LCOutSAV[SAV,PA]))$
 $LUC_SAV_PA_to_SAV_FA = (MAX(0,LCOutSAV[SAV,PA]*RT_SAV_PA_to_SAV_FA*(1-$
 $(\bullet Equil_Low_S[SAV,PA]/LCOutSAV[SAV,PA])))+MIN(0,LCOutSAV[SAV,FA]*RT_SAV_PA_to_SAV$
 $_FA*(1-(\bullet Equil_Low_S[SAV,FA]/LCOutSAV[SAV,FA])))$
 $SAV_UR(t) = SAV_UR(t - dt) + (LUC_SAV_CR_to_SAV_UR + LUC_SAV_PA_to_SAV_UR +$
 $LUC_SAV_NE_to_SAV_UR + LUC_SAV_FA_to_SAV_UR) * dt$
 $INIT SAV_UR = IC_LCLU[SAV,UR]$

INFLOWS:

$LUC_SAV_CR_to_SAV_UR = Land_Cover_SAV_Conversion_Rt[CR,UR]*LCOutSAV[SAV,CR]*(1-$
 $(\bullet Equil_Low_S[SAV,CR]/LCOutSAV[SAV,CR]))$
 $LUC_SAV_PA_to_SAV_UR = Land_Cover_SAV_Conversion_Rt[PA,UR]*LCOutSAV[SAV,PA]*(1-$
 $(\bullet Equil_Low_S[SAV,PA]/LCOutSAV[SAV,PA]))$
 $LUC_SAV_NE_to_SAV_UR = Land_Cover_SAV_Conversion_Rt[NE,UR]*LCOutSAV[SAV,NE]*(1-$
 $(\bullet Equil_Low_S[SAV,NE]/LCOutSAV[SAV,NE]))$
 $LUC_SAV_FA_to_SAV_UR = Land_Cover_SAV_Conversion_Rt[FA,UR]*LCOutSAV[SAV,FA]*(1-$
 $(\bullet Equil_Low_S[SAV,FA]/LCOutSAV[SAV,FA]))$
 $Land_Cover_SAV_Conversion_Rt[LandUses,LandUses] =$
 $\bullet LUC_S_Rural_Effect[LandUses,LandUses]*Rural_Population*1E-$
 $5+\bullet LUC_S_Urban_Effect[LandUses,LandUses]*Urban_Population*1E-$
 $5+\bullet LC_S_conversion[LandUses,LandUses]*GRP_Growth*1E-5$
 $RT_SAV_CR_to_SAV_PA = Land_Cover_SAV_Conversion_Rt[CR,PA]*(1-$
 $(LCOutSAV[SAV,CR]/MAX(LCOutSAV[SAV,CR],\bullet Equil_High_SAV[SAV,CR])))-$
 $Land_Cover_SAV_Conversion_Rt[PA,CR]*(1-$
 $(LCOutSAV[SAV,PA]/Max(LCOutSAV[SAV,PA],\bullet Equil_High_SAV[SAV,PA]))$
 $RT_SAV_FA_to_SAV_AG = Land_Cover_SAV_Conversion_Rt[FA,CR]*(1-$
 $(LCOutSAV[SAV,FA]/MAX(LCOutSAV[SAV,FA],\bullet Equil_High_SAV[SAV,FA])))-$
 $Land_Cover_SAV_Conversion_Rt[FA,FA]*(1-$
 $(LCOutSAV[SAV,CR]/Max(LCOutSAV[SAV,CR],\bullet Equil_High_SAV[SAV,CR]))$
 $RT_SAV_PA_to_SAV_FA = Land_Cover_SAV_Conversion_Rt[PA,FA]*(1-$
 $(LCOutSAV[SAV,PA]/MAX(LCOutSAV[SAV,PA],\bullet Equil_High_SAV[SAV,PA])))-$
 $Land_Cover_SAV_Conversion_Rt[FA,PA]*(1-$
 $(LCOutSAV[SAV,FA]/Max(LCOutSAV[SAV,FA],\bullet Equil_High_SAV[SAV,FA]))$
 $\bullet Equil_High_SAV[AMF,NE] = 0$
 $\bullet Equil_High_SAV[AMF,CR] = 0$
 $\bullet Equil_High_SAV[AMF,PA] = 0$
 $\bullet Equil_High_SAV[AMF,FA] = 0$
 $\bullet Equil_High_SAV[AMF,UR] = 0$
 $\bullet Equil_High_SAV[SAV,NE] = 1$
 $\bullet Equil_High_SAV[SAV,CR] = 1$
 $\bullet Equil_High_SAV[SAV,PA] = 1$
 $\bullet Equil_High_SAV[SAV,FA] = 1$

- Equil_High_SAV[SAV,UR] = 1
- Equil_High_SAV[RIV,NE] = 0
- Equil_High_SAV[RIV,CR] = 0
- Equil_High_SAV[RIV,PA] = 0
- Equil_High_SAV[RIV,FA] = 0
- Equil_High_SAV[RIV,UR] = 0
- Equil_High_SAV[FLF,NE] = 0
- Equil_High_SAV[FLF,CR] = 0
- Equil_High_SAV[FLF,PA] = 0
- Equil_High_SAV[FLF,FA] = 0
- Equil_High_SAV[FLF,UR] = 0
- Equil_Low_S[AMF,NE] = 0
- Equil_Low_S[AMF,CR] = 0
- Equil_Low_S[AMF,PA] = 0
- Equil_Low_S[AMF,FA] = 0
- Equil_Low_S[AMF,UR] = 0
- Equil_Low_S[SAV,NE] = 1
- Equil_Low_S[SAV,CR] = 1
- Equil_Low_S[SAV,PA] = 1
- Equil_Low_S[SAV,FA] = 1
- Equil_Low_S[SAV,UR] = 1
- Equil_Low_S[RIV,NE] = 0
- Equil_Low_S[RIV,CR] = 0
- Equil_Low_S[RIV,PA] = 0
- Equil_Low_S[RIV,FA] = 0
- Equil_Low_S[RIV,UR] = 0
- Equil_Low_S[FLF,NE] = 0
- Equil_Low_S[FLF,CR] = 1
- Equil_Low_S[FLF,PA] = 1
- Equil_Low_S[FLF,FA] = 1
- Equil_Low_S[FLF,UR] = 1
- LC_S_conversion[NE,NE] = 0
- LC_S_conversion[NE,CR] = 1e-5
- LC_S_conversion[NE,PA] = 1e-5
- LC_S_conversion[NE,FA] = 0
- LC_S_conversion[NE,UR] = 1e-5
- LC_S_conversion[CR,NE] = 0
- LC_S_conversion[CR,CR] = 0
- LC_S_conversion[CR,PA] = 1
- LC_S_conversion[CR,FA] = 1
- LC_S_conversion[CR,UR] = 1
- LC_S_conversion[PA,NE] = 0
- LC_S_conversion[PA,CR] = 1
- LC_S_conversion[PA,PA] = 0
- LC_S_conversion[PA,FA] = 1
- LC_S_conversion[PA,UR] = 1
- LC_S_conversion[FA,NE] = 1
- LC_S_conversion[FA,CR] = 1
- LC_S_conversion[FA,PA] = 1
- LC_S_conversion[FA,FA] = 0
- LC_S_conversion[FA,UR] = 1
- LC_S_conversion[UR,NE] = 0
- LC_S_conversion[UR,CR] = 0
- LC_S_conversion[UR,PA] = 0
- LC_S_conversion[UR,FA] = 0
- LC_S_conversion[UR,UR] = 0

- LUC_S_Rural_Effect[LandUses,LandUses] = 0
- LUC_S_Urban_Effect[LandUses,LandUses] = 0

Database

Area_per_residence = 360/1e6

CE_Data = 32.2

DIN_Data = 9.6E5

ETCal = ARRAYSUM(AmazonLand[*,*])*1e6*1.25

Exports_Data = (Inter_regional_Export_Data+Int_Exports_Data)/1E3

Flooded_Forest = 182100

GRP_Per_Cap_DATA = IF Pop_Data=0 then 0 ELSE GRP_Data/Pop_Data

Imports_Data = (Int_Imports_Data+Inter_regional_Import_Data)/1E3

IncomingSed_Data = 579.4E6

InSystSed_Data = 414.7E6

Lakes&Rivers = 67900

Land_use_savanna =

Agriculture_in_Savanna+Pasture_in_Savanna+Fallow_in_Savanna+Urban_in_Savanna

ME_Data = 246.9

Net_Imp_Exports_Data = (Int_Exports_Data+Inter_regional_Export_Data)-

(Int_Imports_Data+Inter_regional_Import_Data)

NPP_Cal[AMF,NE] = 1560

NPP_Cal[AMF,CR] = 650

NPP_Cal[AMF,PA] = 700

NPP_Cal[AMF,FA] = 1000

NPP_Cal[AMF,UR] = 110

NPP_Cal[SAV,NE] = 500

NPP_Cal[SAV,CR] = 650

NPP_Cal[SAV,PA] = 700

NPP_Cal[SAV,FA] = 400

NPP_Cal[SAV,UR] = 110

NPP_Cal[RIV,NE] = 45

NPP_Cal[RIV,CR] = 0

NPP_Cal[RIV,PA] = 0

NPP_Cal[RIV,FA] = 0

NPP_Cal[RIV,UR] = 0

NPP_Cal[FLF,NE] = 1665

NPP_Cal[FLF,CR] = 0

NPP_Cal[FLF,PA] = 0

NPP_Cal[FLF,FA] = 0

NPP_Cal[FLF,UR] = 0

ORGN_Data = 21.8E5

Org_Matter_Cal = Pop_Data*3.5*1e6

Original_Forest_Amazon = 5032925

Original_Savannah = 847400

Percentage_of_18_years_old_and_older = 0.50

Percentage_of_Forest_Loss = Deforested_Area_INPE/Original_Forest_Amazon

PrecCal = ARRAYSUM(AmazonLand[*,*])*1e6*2.3

Rate_of_Disposal = 0.18

Rate_of_Public_Area = 5

Remaining_Forest = Original_Forest_Amazon-

(Agriculture_in_Forest+Fallow_in_Forest+Pasture_in_Forest-

Urban_in_Forest+Lakes&Rivers+Flooded_Forest+Savanna)

Remaining_Savanna = Original_Savannah-

(Agriculture_in_Savanna+Fallow_in_Savanna+Pasture_in_Savanna-Urban_in_Savanna)

RunoffCal = ARRAYSUM(AmazonLand[*,*])*1.05

Rural_Pop_Percentage = Rural_Pop_Data/•IC_Amazon_Population

Savanna = 847400
 SedDischarge_Data = 1140E6
 Social_Net_Cal =
 Pop_Data*Percentage_of_18_years_old_and_older*Participation_on_Labor_Unions_and_Civil_Associations
 SoilC_Data[AMF,NE] = 2220
 SoilC_Data[AMF,CR] = 0
 SoilC_Data[AMF,PA] = 2660
 SoilC_Data[AMF,FA] = 2050
 SoilC_Data[AMF,UR] = 0
 SoilC_Data[SAV,NE] = 0
 SoilC_Data[SAV,CR] = 0
 SoilC_Data[SAV,PA] = 0
 SoilC_Data[SAV,FA] = 0
 SoilC_Data[SAV,UR] = 0
 SoilC_Data[RIV,NE] = 2220
 SoilC_Data[RIV,CR] = 2220
 SoilC_Data[RIV,PA] = 2220
 SoilC_Data[RIV,FA] = 2220
 SoilC_Data[RIV,UR] = 2220
 SoilC_Data[FLF,NE] = 2220
 SoilC_Data[FLF,CR] = 2220
 SoilC_Data[FLF,PA] = 2220
 SoilC_Data[FLF,FA] = 2220
 SoilC_Data[FLF,UR] = 2220
 SoilN_Data[AMF,NE] = 180
 SoilN_Data[AMF,CR] = 150
 SoilN_Data[AMF,PA] = 238
 SoilN_Data[AMF,FA] = 160
 SoilN_Data[AMF,UR] = 0
 SoilN_Data[SAV,NE] = 180
 SoilN_Data[SAV,CR] = 180
 SoilN_Data[SAV,PA] = 180
 SoilN_Data[SAV,FA] = 180
 SoilN_Data[SAV,UR] = 180
 SoilN_Data[RIV,NE] = 0
 SoilN_Data[RIV,CR] = 0
 SoilN_Data[RIV,PA] = 0
 SoilN_Data[RIV,FA] = 0
 SoilN_Data[RIV,UR] = 0
 SoilN_Data[FLF,NE] = 0
 SoilN_Data[FLF,CR] = 0
 SoilN_Data[FLF,PA] = 0
 SoilN_Data[FLF,FA] = 0
 SoilN_Data[FLF,UR] = 0
 TOM_Data = 32.7E6
 Total_Agriculture = Agriculture_in_Forest+Agriculture_in_Savanna
 Total_Atm_Exchange_Data = 18.1E6
 Total_DIC_Data = 40.2E6
 Total_Fallow = Fallow_in_Forest+Fallow_in_Savanna
 Total_Land_Cover_Amazon_&_Cerrado =
 Lakes&Rivers+Flooded_Forest+Remaining_Forest+Remaining_Savanna+Total_Agriculture+Total_Fallow
 +Total_Pasture+Total_Urban
 Total_Pasture = Pasture_in_Forest+Pasture_in_Savanna
 Total_Urban = Urban_in_Forest+Urban_in_Savanna
 Urban_Pop_Data = •IC_Amazon_Population-Rural_Pop_Data

Urban_Pop_Percentage = Urban_Pop_Data/•IC_Amazon_Population
 Waste_Collected = 0.506*Waste_Produced_Data
 Waste_Disposed_Environment = Waste_Produced_Data*Rate_of_Disposal
 Water_Use_Cal = Pop_Data*0.15*365.25*1e6
 Agriculture_in_Forest = GRAPH(TIME)
 (1975, 13705), (1985, 62027), (1995, 55226)
 Agriculture_in_Savanna = GRAPH(TIME)
 (1975, 14861), (1985, 23718), (1995, 19152)
 Annual_Deforestation_Data = GRAPH(TIME)
 (1977, 21130), (1978, 21130), (1979, 21130), (1980, 21130), (1981, 21130), (1982, 21130), (1983, 21130),
 (1984, 21130), (1985, 21130), (1986, 21130), (1987, 21130), (1988, 21130), (1989, 17860), (1990, 13810),
 (1991, 11130), (1992, 13786), (1993, 14896), (1994, 14896), (1995, 29059), (1996, 18161), (1997, 13227),
 (1998, 17383), (1999, 17259), (2000, 18226), (2001, 25000)
 Deforested_Area_INPE = GRAPH(TIME)
 (1978, 152200), (1979, 174730), (1980, 197260), (1981, 219790), (1982, 242320), (1983, 264850), (1984,
 287380), (1985, 309910), (1986, 332440), (1987, 354970), (1988, 377500), (1989, 401400), (1990,
 415200), (1991, 426400), (1992, 440186), (1993, 455082), (1994, 469978), (1995, 497055), (1996,
 517069), (1997, 532086), (1998, 551782), (1999, 569269), (2000, 587727)
 EXPORT_DATA = GRAPH(TIME)
 (1975, 1.97), (1980, 4.58), (1985, 6.32), (1990, 9.76)
 Fallow_in_Forest = GRAPH(TIME)
 (1975, 36843), (1985, 212427), (1995, 108076)
 Fallow_in_Savanna = GRAPH(TIME)
 (1975, 62107), (1985, 52066), (1995, 24620)
 FireCal = GRAPH(TIME)
 (1999, 80760), (2000, 70252), (2001, 60206), (2002, 100371)
 GRP_Data = GRAPH(TIME)
 (1985, 18.1), (1986, 24.2), (1987, 25.5), (1988, 28.3), (1989, 41.8), (1990, 41.7), (1991, 33.9), (1992, 29.7),
 (1993, 37.5), (1994, 45.5), (1995, 52.5), (1996, 57.3), (1997, 33.4), (1998, 34.6), (1999, 28.4), (2000, 27.8),
 (2001, 34.8)
 Human_Births_Data = GRAPH(TIME)
 (1985, 0.179), (1990, 0.174), (1995, 0.149), (2000, 0.253)
 Human_Death_Data = GRAPH(TIME)
 (1985, 0.0575), (1990, 0.0624), (1995, 0.0651), (2000, 0.0692)
 Hydro_Energy_Data = GRAPH(TIME)
 (1975, 2.50), (1980, 5.80), (1985, 11.2), (1990, 16.5), (1995, 21.8), (2000, 27.2)
 IMPORT_DATA = GRAPH(TIME)
 (1975, 3.77), (1980, 6.93), (1985, 8.46), (1990, 7.60)
 Inter_regional_Export_Data = GRAPH(TIME)
 (1970, 224), (1975, 703), (1980, 3138), (1985, 5573), (1990, 8079)
 Inter_regional_Import_Data = GRAPH(TIME)
 (1970, 223), (1975, 1547), (1980, 4563), (1985, 7550), (1990, 6290)
 Int_Exports_Data = GRAPH(TIME)
 (1970, 881), (1975, 1264), (1980, 1439), (1985, 751), (1990, 1678)
 Int_Imports_Data = GRAPH(TIME)
 (1975, 1158), (1979, 2194), (1982, 2371), (1986, 909), (1990, 1313)
 Participation_on_Labor_Unions_and_Civil_Associations = GRAPH(TIME)
 (1975, 0.257), (1980, 0.27), (1985, 0.282), (1990, 0.295), (1995, 0.307), (2000, 0.32)
 Pasture_in_Forest = GRAPH(TIME)
 (1975, 37842), (1985, 148810), (1995, 228321)
 Pasture_in_Savanna = GRAPH(TIME)
 (1975, 110430), (1985, 231497), (1995, 234637)
 Percentage_of_Forest_Loss_INPE = GRAPH(TIME)
 (1977, 0.54), (1978, 0.54), (1979, 0.54), (1980, 0.54), (1981, 0.54), (1982, 0.54), (1983, 0.54), (1984, 0.54),
 (1985, 0.54), (1986, 0.54), (1987, 0.54), (1988, 0.54), (1989, 0.48), (1990, 0.37), (1991, 0.3), (1992, 0.38),
 (1993, 0.41), (1994, 0.41), (1995, 0.8), (1996, 0.51), (1997, 0.37), (1998, 0.51), (1999, 0.49), (2000, 0.52)

Pop_Data = GRAPH(TIME)
 (1970, 8.19), (1980, 11.0), (1990, 17.9), (2000, 22.2)
 Residences_in_Forest = GRAPH(TIME)
 (1940, 139089), (1950, 188358), (1960, 306399), (1970, 512500), (1980, 901410), (1990, 1.9e+06)
 Residences_in_Savanna = GRAPH(TIME)
 (1940, 139089), (1950, 188358), (1960, 306399), (1970, 512500), (1980, 901410), (1990, 1.9e+06)
 Roads_Data = GRAPH(TIME)
 (1975, 6251), (1980, 6848), (1985, 10230), (1990, 12701), (1995, 15172)
 Rural_Pop_Data = GRAPH(TIME)
 (1940, 2.4e+06), (1950, 2.9e+06), (1960, 4.2e+06), (1970, 5.1e+06), (1980, 6.1e+06), (1990, 7.6e+06),
 (2000, 6.7e+06)
 Urban_in_Forest = GRAPH(TIME)
 (1975, 337), (1985, 783), (1995, 1673)
 Urban_in_Savanna = GRAPH(TIME)
 (1975, 365), (1985, 515), (1995, 1059)
 Waste_Produced_Data = GRAPH(TIME)
 (1970, 4.46), (1980, 5.99), (1990, 9.20), (2000, 11.5)
 •IC_Amazon_Population = GRAPH(TIME)
 (1940, 3.1e+06), (1950, 3.9e+06), (1960, 5.9e+06), (1970, 8.2e+06), (1980, 1.1e+07), (1990, 1.7e+07),
 (2000, 2.1e+07)

DEBT SECTOR

$DEBT(t) = DEBT(t - dt) + (Imports + Interest + Devaluation_ \& _ Valuation - Exports -$
 $In_ \& _ Out_ Investiments) * dt$
 INIT DEBT = 0

INFLOWS:

Imports = Demand_Deficit*0.5
 Interest = DEBT*Interest_Rate
 Devaluation_ \& _ Valuation = DEBT*Devaluation_Events_and_rates

OUTFLOWS:

Exports = GS_Debt_Release+DEBT*Exogenous_Influences
 In_ \& _ Out_ Investiments = In_Investment-Out_Investment
 Debt_GRP_Rate = IF GRP=0 THEN 0 ELSE DEBT/GRP
 Demand_Deficit = Fossil_Fuels_Imported+Imported_Ore+Imported_Water+OM_imported
 Exogenous_Influences = 0.25

•IC_Debt = 1

Devaluation_Events_and_rates = GRAPH(TIME)
 (1974, 0.00), (1975, 0.00), (1976, 0.00), (1977, 0.00), (1978, 0.00), (1979, 0.00), (1980, 0.00), (1981, 0.00),
 (1982, 0.00), (1983, 0.00), (1984, 0.00), (1985, 0.00), (1986, 0.00), (1987, 0.00), (1988, 0.00), (1989, 0.00),
 (1990, 0.00), (1991, 0.00), (1992, 0.00), (1993, 0.00), (1994, 0.00), (1995, 0.00), (1996, 0.00), (1997, 0.00),
 (1998, 0.00), (1999, 0.00), (2000, 0.00), (2001, 0.00), (2002, 0.00), (2003, 0.00), (2004, 0.00), (2005, 0.00),
 (2006, 0.00), (2007, 0.00), (2008, 0.00), (2009, 0.00), (2010, 0.00), (2011, 0.00), (2012, 0.00), (2013, 0.00),
 (2014, 0.00), (2015, 0.00), (2016, 0.00), (2017, 0.00), (2018, 0.00), (2019, 0.00), (2020, 0.00), (2021, 0.00),
 (2022, 0.00), (2023, 0.00), (2024, 0.00), (2025, 0.00), (2026, 0.00), (2027, 0.00), (2028, 0.00), (2029, 0.00),
 (2030, 0.00), (2031, 0.00), (2032, 0.00), (2033, 0.00), (2034, 0.00), (2035, 0.00), (2036, 0.00), (2037, 0.00),
 (2038, 0.00), (2039, 0.00), (2040, 0.00), (2041, 0.00), (2042, 0.00), (2043, 0.00), (2044, 0.00), (2045, 0.00),
 (2046, 0.00), (2047, 0.00), (2048, 0.00), (2049, 0.00), (2050, 0.00), (2051, 0.00), (2052, 0.00), (2053, 0.00),
 (2054, 0.00), (2055, 0.00), (2056, 0.00), (2057, 0.00), (2058, 0.00), (2059, 0.00), (2060, 0.00), (2061, 0.00),
 (2062, 0.00), (2063, 0.00), (2064, 0.00), (2065, 0.00), (2066, 0.00), (2067, 0.00), (2068, 0.00), (2069, 0.00),
 (2070, 0.00), (2071, 0.00), (2072, 0.00), (2073, 0.00), (2074, 0.00), (2075, 0.00), (2076, 0.00), (2077, 0.00),
 (2078, 0.00), (2079, 0.00), (2080, 0.00), (2081, 0.00), (2082, 0.00), (2083, 0.00), (2084, 0.00), (2085, 0.00),
 (2086, 0.00), (2087, 0.00), (2088, 0.00), (2089, 0.00), (2090, 0.00), (2091, 0.00), (2092, 0.00), (2093, 0.00),
 (2094, 0.00), (2095, 0.00), (2096, 0.00), (2097, 0.00), (2098, 0.00), (2099, 0.00), (2100, 0.00)
 Interest_Rate = GRAPH(Imports)

(0.00, 0.025), (10.0, 0.025), (20.0, 0.02), (30.0, 0.02), (40.0, 0.055), (50.0, 0.11), (60.0, 0.16), (70.0, 0.25), (80.0, 0.405), (90.0, 0.545), (100, 0.67)

In_Investment = GRAPH(GRP)

(0.00, 9.15), (30.0, 7.40), (60.0, 5.95), (90.0, 4.90), (120, 4.10), (150, 3.60), (180, 3.25), (210, 3.00), (240, 2.85), (270, 2.80), (300, 2.80)

Out_Investment = GRAPH(GRP)

(0.00, 0.00), (30.0, 4.62), (60.0, 8.54), (90.0, 12.0), (120, 14.2), (150, 15.8), (180, 17.4), (210, 18.0), (240, 18.3), (270, 18.3), (300, 18.3)

EcosystemservicesWithinSectorAnthrosphere

Climate_Reg_km2[LandCovers, LandUses] = IF AmazonLand[LandCovers, LandUses]=0 THEN 0 ELSE

Climate_Reg_Serv[LandCovers, LandUses]*1e6/AmazonLand[LandCovers, LandUses]

Climate_Reg_Serv[LandCovers, LandUses] = IF

Total_Net_Ecosystem_Production[LandCovers, LandUses]=0 THEN 0 ELSE

1/(Regional_Temperature/(Total_Net_Ecosystem_Production[LandCovers, LandUses]*1E3))

CL_Reg_\$_km2[LandCovers, LandUses] =

Per_Cl_Reg[LandCovers, LandUses]*EcoServices_values[Climate_Regul]*1E9

CR_\$_Unit[LandCovers, LandUses] = IF Climate_Reg_km2[LandCovers, LandUses]=0 THEN 0 ELSE

CL_Reg_\$_km2[LandCovers, LandUses]/Climate_Reg_km2[LandCovers, LandUses]

Disturbance_Reg_Serv[LandCovers, LandUses] = IF Total_C_Biomass[LandCovers, LandUses]=0 THEN 0

ELSE Total_C_Biomass[LandCovers, LandUses]/1e6

Dist_Reg_\$_km2[LandCovers, LandUses] =

Per_Dis_Reg[LandCovers, LandUses]*EcoServices_values[Dist_Regul]*1E9

Dist_Reg_km2[LandCovers, LandUses] = IF AmazonLand[LandCovers, LandUses]=0 THEN 0 ELSE

Disturbance_Reg_Serv[LandCovers, LandUses]*1e6/AmazonLand[LandCovers, LandUses]

DR_\$_Unit[LandCovers, LandUses] = IF Dist_Reg_km2[LandCovers, LandUses]=0 THEN 0 ELSE

Dist_Reg_\$_km2[LandCovers, LandUses]/Dist_Reg_km2[LandCovers, LandUses]

EcoServices_Contribution =

(TECOservices[Gas_Regul]^•ES_Exp[Gas_Regul]*TECOservices[Climate_Regul]^•ES_Exp[Climate_Regul]*TECOservices[Dist_Regul]^•ES_Exp[Dist_Regul]*TECOservices[Org_Soil_Form]^•ES_Exp[Org_Soil_Form]*TECOservices[Nutrient_Uptake]^•ES_Exp[Nutrient_Uptake]*TECOservices[Waste_Ass_Pot]^•ES_Exp[Waste_Ass_Pot]*TECOservices[Rec_Cult]^•ES_Exp[Rec_Cult])

EcoServices_Value = ARRAYSUM(EcoServices_values[*])

EcoServices_values[EcoService_Type] =

(Price_ECO_Services[EcoService_Type]*TECOservices[EcoService_Type])*1e6/1e9

Gas_Reg_\$_km2[LandCovers, LandUses] =

Per_Gas_R[LandCovers, LandUses]*EcoServices_values[Gas_Regul]*1E9

Gas_Reg_km2[LandCovers, LandUses] = IF AmazonLand[LandCovers, LandUses]=0 THEN 0 ELSE

Gas_Reg_Serv[LandCovers, LandUses]*1e6/AmazonLand[LandCovers, LandUses]

Gas_Reg_Serv[LandCovers, LandUses] = (Amazon_NEP_Carbon_Uptake[LandCovers, LandUses])/1E6

GR_\$_Unit[LandCovers, LandUses] = IF Gas_Reg_km2[LandCovers, LandUses]=0 THEN 0 ELSE

Gas_Reg_\$_km2[LandCovers, LandUses]/Gas_Reg_km2[LandCovers, LandUses]

Org_Soil_Form_km2[LandCovers, LandUses] = IF AmazonLand[LandCovers, LandUses]=0 THEN 0

ELSE Org_Soil_Form_Serv[LandCovers, LandUses]*1e6/AmazonLand[LandCovers, LandUses]

Org_Soil_Form_Serv[LandCovers, LandUses] = Org_Soil_Formation[LandCovers, LandUses]/1e6

OS_\$_km2[LandCovers, LandUses] =

Per_Soil_Form[LandCovers, LandUses]*EcoServices_values[Org_Soil_Form]*1E9

OS_\$_Unit[LandCovers, LandUses] = IF Org_Soil_Form_km2[LandCovers, LandUses]=0 THEN 0 ELSE

OS_\$_km2[LandCovers, LandUses]/Org_Soil_Form_km2[LandCovers, LandUses]

Per_Cl_Reg[LandCovers, LandUses] = IF AmazonLand[LandCovers, LandUses]=0 THEN 0 ELSE

Climate_Reg_Serv[LandCovers, LandUses]/(TECOservices[Climate_Regul]*AmazonLand[LandCovers, LandUses])

Per_Dis_Reg[LandCovers, LandUses] = IF AmazonLand[LandCovers, LandUses]=0 THEN 0 ELSE

Disturbance_Reg_Serv[LandCovers, LandUses]/(TECOservices[Dist_Regul]*AmazonLand[LandCovers, LandUses])

Per_Gas_R[LandCovers, LandUses] = IF AmazonLand[LandCovers, LandUses]=0 THEN 0 ELSE

```

Gas_Reg_Serv[LandCovers,LandUses]/(TECOservices[Gas_Regul]*AmazonLand[LandCovers,LandUses]
)
Per_Plant_N_uptake[LandCovers,LandUses] = IF AmazonLand[LandCovers,LandUses]=0 THEN 0 ELSE
Plant_N_Uptake_Serv[LandCovers,LandUses]/(TECOservices[Nutrient_Uptake]*AmazonLand[LandCove
rs,LandUses])
Per_Rec_Cul[LandCovers,LandUses] = IF AmazonLand[LandCovers,LandUses]=0 THEN 0 ELSE
Recreation_Cultural_Serv[LandCovers,LandUses]/(TECOservices[Rec_Cult]*AmazonLand[LandCovers,L
andUses])
Per_Soil_Form[LandCovers,LandUses] = IF AmazonLand[LandCovers,LandUses]=0 THEN 0 ELSE
Org_Soil_Form_Serv[LandCovers,LandUses]/(TECOservices[Org_Soil_Form]*AmazonLand[LandCovers
,LandUses])
Per_Was_Ass[LandCovers,LandUses] = IF AmazonLand[LandCovers,LandUses]=0 THEN 0 ELSE
Waste_Assimilation_Serv/(TECOservices[Waste_Ass_Pot]*AmazonLand[LandCovers,LandUses])
Plant_N_Uptake_Serv[LandCovers,LandUses] = Plant_N_Uptake[LandCovers,LandUses]/1E6
PNU_$_km2[LandCovers,LandUses] =
Per_Plant_N_uptake[LandCovers,LandUses]*EcoServices_values[Nutrient_Uptake]*1E9
PNU_k2[LandCovers,LandUses] = IF AmazonLand[LandCovers,LandUses]=0 THEN 0 ELSE
Plant_N_Uptake_Serv[LandCovers,LandUses]*1e6/AmazonLand[LandCovers,LandUses]
PN_$_Unit[LandCovers,LandUses] = IF PNU_k2[LandCovers,LandUses]=0 THEN 0 ELSE
PNU_$_km2[LandCovers,LandUses]/PNU_k2[LandCovers,LandUses]
Price_ECO_Services[EcoService_Type] = IF TECOservices[EcoService_Type]=0 THEN 0 ELSE
(•ES_Exp[EcoService_Type]*GS_Econ_Prod*1e9)/(TECOservices[EcoService_Type]*1e6)
RC_$_Unit[LandCovers,LandUses] = IF Rec_Cult_k2[LandCovers,LandUses]=0 THEN 0 ELSE
Rec_Cult_$_km2[LandCovers,LandUses]/Rec_Cult_k2[LandCovers,LandUses]
Recreation_Cultural_Serv[LandCovers,LandUses] = IF SOCIAL_NETWORK<1 OR
Total_C_Biomass[LandCovers,LandUses]=0 then 0 else
((•Biomass_Recreational_Value[LandCovers,LandUses]*(Total_C_Biomass[LandCovers,LandUses])/1E6)
/SOCIAL_NETWORK)
Rec_Cult_$_km2[LandCovers,LandUses] =
EcoServices_values[Rec_Cult]*Per_Rec_Cul[LandCovers,LandUses]*1E9
Rec_Cult_k2[LandCovers,LandUses] = IF AmazonLand[LandCovers,LandUses]=0 THEN 0 ELSE
Recreation_Cultural_Serv[LandCovers,LandUses]*1e6/AmazonLand[LandCovers,LandUses]
TECOservices[Rec_Cult] = ARRAYSUM(Recreation_Cultural_Serv[AMF,
*])+ARRAYSUM(Recreation_Cultural_Serv[SAV, *])+ARRAYSUM(Recreation_Cultural_Serv[RIV,
*])+ARRAYSUM(Recreation_Cultural_Serv[FLF,
*])+0*(Climate_Reg_Serv[AMF,NE]+Disturbance_Reg_Serv[AMF,NE]+Gas_Reg_Serv[AMF,NE]+Org_
Soil_Form_Serv[AMF,NE]+Plant_N_Uptake_Serv[AMF,NE]+Recreation_Cultural_Serv[AMF,NE]+Wast
e_Assimilation_Serv)
TECOservices[Gas_Regul] = ARRAYSUM(Gas_Reg_Serv[AMF,
*])+ARRAYSUM(Gas_Reg_Serv[SAV, *])+ARRAYSUM(Gas_Reg_Serv[RIV,
*])+ARRAYSUM(Gas_Reg_Serv[FLF,
*])+0*(Climate_Reg_Serv[AMF,NE]+Disturbance_Reg_Serv[AMF,NE]+Gas_Reg_Serv[AMF,NE]+Org_
Soil_Form_Serv[AMF,NE]+Plant_N_Uptake_Serv[AMF,NE]+Recreation_Cultural_Serv[AMF,NE]+Wast
e_Assimilation_Serv)
TECOservices[Climate_Regul] = ARRAYSUM(Climate_Reg_Serv[AMF,
*])+ARRAYSUM(Climate_Reg_Serv[SAV, *])+ARRAYSUM(Climate_Reg_Serv[RIV,
*])+ARRAYSUM(Climate_Reg_Serv[FLF,
*])+0*(Climate_Reg_Serv[AMF,NE]+Disturbance_Reg_Serv[AMF,NE]+Gas_Reg_Serv[AMF,NE]+Org_
Soil_Form_Serv[AMF,NE]+Plant_N_Uptake_Serv[AMF,NE]+Recreation_Cultural_Serv[AMF,NE]+Wast
e_Assimilation_Serv)
TECOservices[Dist_Regul] = ARRAYSUM(Disturbance_Reg_Serv[AMF,
*])+ARRAYSUM(Disturbance_Reg_Serv[SAV, *])+ARRAYSUM(Disturbance_Reg_Serv[RIV,
*])+ARRAYSUM(Disturbance_Reg_Serv[FLF,
*])+0*(Climate_Reg_Serv[AMF,NE]+Disturbance_Reg_Serv[AMF,NE]+Gas_Reg_Serv[AMF,NE]+Org_
Soil_Form_Serv[AMF,NE]+Plant_N_Uptake_Serv[AMF,NE]+Recreation_Cultural_Serv[AMF,NE]+Wast
e_Assimilation_Serv)

```

```

TECOservices[Waste_Ass_Pot] =
Waste_Assimilation_Serv+0*(Climate_Reg_Serv[AMF,NE]+Disturbance_Reg_Serv[AMF,NE]+Gas_Reg
_Serv[AMF,NE]+Org_Soil_Form_Serv[AMF,NE]+Plant_N_Uptake_Serv[AMF,NE]+Recreation_Cultural
_Serv[AMF,NE]+Waste_Assimilation_Serv)
TECOservices[Nutrient_Uptake] = ARRAYSUM(Plant_N_Uptake_Serv[AMF,
*])+ARRAYSUM(Plant_N_Uptake_Serv[SAV,*])+ARRAYSUM(Plant_N_Uptake_Serv[RIV,
*])+ARRAYSUM(Plant_N_Uptake_Serv[FLF,
*])+0*(Climate_Reg_Serv[AMF,NE]+Disturbance_Reg_Serv[AMF,NE]+Gas_Reg_Serv[AMF,NE]+Org_
Soil_Form_Serv[AMF,NE]+Plant_N_Uptake_Serv[AMF,NE]+Recreation_Cultural_Serv[AMF,NE]+Wast
e_Assimilation_Serv)
TECOservices[Org_Soil_Form] = ARRAYSUM(Org_Soil_Form_Serv[AMF,
*])+ARRAYSUM(Org_Soil_Form_Serv[SAV,*])+ARRAYSUM(Org_Soil_Form_Serv[RIV,
*])+ARRAYSUM(Org_Soil_Form_Serv[FLF,
*])+0*(Climate_Reg_Serv[AMF,NE]+Disturbance_Reg_Serv[AMF,NE]+Gas_Reg_Serv[AMF,NE]+Org_
Soil_Form_Serv[AMF,NE]+Plant_N_Uptake_Serv[AMF,NE]+Recreation_Cultural_Serv[AMF,NE]+Wast
e_Assimilation_Serv)
TOTAL_BIOMASS = ARRAYSUM(Total_C_Biomass[*,*])
Total_C_Biomass[LandCovers,LandUses] =
Autotrophs[LandCovers,LandUses]+Consumers[LandCovers,LandUses]+Dead_OM[LandCovers,LandUse
s]+Decomposers[LandCovers,LandUses]
TOTAL_PRICE_KM2[LandCovers,LandUses] =
Rec_Cult_$_km2[LandCovers,LandUses]+Gas_Reg_$_km2[LandCovers,LandUses]+CL_Reg_$_km2[La
ndCovers,LandUses]+Dist_Reg_$_km2[LandCovers,LandUses]+Waste_Ass_$_km2[LandCovers,LandUs
es]+PNU_$_km2[LandCovers,LandUses]+OS_$_km2[LandCovers,LandUses]
Waste_Assimilation_Serv = Waste_Assimilation_Potential
Waste_Ass_$_km2[LandCovers,LandUses] =
Per_Was_Ass[LandCovers,LandUses]*EcoServices_values[Waste_Ass_Pot]*1E9
Waste_Ass_km2[LandCovers,LandUses] = IF AmazonLand[LandCovers,LandUses]=0 THEN 0 ELSE
Waste_Assimilation_Serv*1e6/AmazonLand[LandCovers,LandUses]
WA_$_Unit[LandCovers,LandUses] = Price_ECO_Services[Waste_Ass_Pot]
•Biomass_Recreational_Value[AMF,NE] = 1
•Biomass_Recreational_Value[AMF,CR] = 0.1
•Biomass_Recreational_Value[AMF,PA] = 0.1
•Biomass_Recreational_Value[AMF,FA] = 0.25
•Biomass_Recreational_Value[AMF,UR] = 0.75
•Biomass_Recreational_Value[SAV,NE] = 1
•Biomass_Recreational_Value[SAV,CR] = 0.1
•Biomass_Recreational_Value[SAV,PA] = 0.1
•Biomass_Recreational_Value[SAV,FA] = 0.25
•Biomass_Recreational_Value[SAV,UR] = 0.75
•Biomass_Recreational_Value[RIV,NE] = 1
•Biomass_Recreational_Value[RIV,CR] = 1
•Biomass_Recreational_Value[RIV,PA] = 1
•Biomass_Recreational_Value[RIV,FA] = 1
•Biomass_Recreational_Value[RIV,UR] = 1
•Biomass_Recreational_Value[FLF,NE] = 1
•Biomass_Recreational_Value[FLF,CR] = 1
•Biomass_Recreational_Value[FLF,PA] = 1
•Biomass_Recreational_Value[FLF,FA] = 1
•Biomass_Recreational_Value[FLF,UR] = 1
•ES_Exp[Rec_Cult] = 1
•ES_Exp[Gas_Regul] = 1
•ES_Exp[Climate_Regul] = 1
•ES_Exp[Dist_Regul] = 1
•ES_Exp[Waste_Ass_Pot] = 1
•ES_Exp[Nutrient_Uptake] = 1

```

•ES_Exp[Org_Soil_Form] = 1

EnergyWithinSectorAtmosphere

Land_Cover_Energy[LandCovers,LandUses](t) = Land_Cover_Energy[LandCovers,LandUses](t - dt) + (Solar_to_Earth[LandCovers,LandUses] - Land_cover_to_Atmosphere[LandCovers,LandUses] - Spatial_Energy_Flux[LandCovers,LandUses]) * dt

INIT Land_Cover_Energy[LandCovers,LandUses] = •ICAMENERGY[LandCovers,LandUses]

INFLOWS:

Solar_to_Earth[LandCovers,LandUses] = (((•Solar_Constant {J/m2/yr} * (1 - •Albedo_Surface[LandCovers,LandUses]))/2))

OUTFLOWS:

Land_cover_to_Atmosphere[LandCovers,LandUses] = ((•Imperfect_Emissivity[LandCovers,LandUses])*

Heat_Retention[LandCovers,LandUses]*•Boltzmann_k[LandCovers,LandUses] {J/m2/yr K4} *

Temp_in_K[LandCovers,LandUses]^Exp_Factor[LandCovers,LandUses]{K4})

Spatial_Energy_Flux[LandCovers,LandUses] = ((ARRAYSUM(Land_Cover_Energy[*,*])/12)-

Land_Cover_Energy[LandCovers,LandUses])*Heat_Conductivity*Nonexistent_LandUses[LandCovers,La
ndUses]

Amazon_Region_Energy = ARRAYSUM(Land_Cover_Energy[AMF,

*)+ARRAYSUM(Land_Cover_Energy[SAV, *)+ARRAYSUM(Land_Cover_Energy[RIV,

*)+ARRAYSUM(Land_Cover_Energy[FLF, *)

CO2_Increase_Factor[LandCovers,LandUses] = Bioavailable_IOC[LandCovers,LandUses]/330.75

Density_Water = 1000

Exp_Factor[LandCovers,LandUses] = 4

Heat_Capacity[LandCovers,LandUses] =

Land_Water_Depth[LandCovers,LandUses]*Density_Water*Specific_Heat_Water

Heat_Conductivity = 0.001

Heat_Retention[LandCovers,LandUses] = 1-

(•CO2_Abs_Calibration*(CO2_Increase_Factor[LandCovers,LandUses]-1))

Incoming_Solar = ARRAYSUM(Solar_to_Earth[*,*])

Land_Water_Depth[AMF,NE] = 450

Land_Water_Depth[AMF,CR] = 355

Land_Water_Depth[AMF,PA] = 500

Land_Water_Depth[AMF,FA] = 500

Land_Water_Depth[AMF,UR] = 465

Land_Water_Depth[SAV,NE] = 650

Land_Water_Depth[SAV,CR] = 625

Land_Water_Depth[SAV,PA] = 600

Land_Water_Depth[SAV,FA] = 600

Land_Water_Depth[SAV,UR] = 600

Land_Water_Depth[RIV,NE] = 100

Land_Water_Depth[RIV,CR] = 0

Land_Water_Depth[RIV,PA] = 0

Land_Water_Depth[RIV,FA] = 0

Land_Water_Depth[RIV,UR] = 0

Land_Water_Depth[FLF,NE] = 500

Land_Water_Depth[FLF,CR] = 0

Land_Water_Depth[FLF,PA] = 0

Land_Water_Depth[FLF,FA] = 0

Land_Water_Depth[FLF,UR] = 0

Needs_to_be_0 = ARRAYSUM(Spatial_Energy_Flux[*,*])

Nonexistent_LandUses[AMF,NE] = 1

Nonexistent_LandUses[AMF,CR] = 1

Nonexistent_LandUses[AMF,PA] = 1

Nonexistent_LandUses[AMF,FA] = 1

Nonexistent_LandUses[AMF,UR] = 1

Nonexistent_LandUses[SAV,NE] = 1

```

Nonexistent_LandUses[SAV,CR] = 1
Nonexistent_LandUses[SAV,PA] = 1
Nonexistent_LandUses[SAV,FA] = 1
Nonexistent_LandUses[SAV,UR] = 1
Nonexistent_LandUses[RIV,NE] = 1
Nonexistent_LandUses[RIV,CR] = 0
Nonexistent_LandUses[RIV,PA] = 0
Nonexistent_LandUses[RIV,FA] = 0
Nonexistent_LandUses[RIV,UR] = 0
Nonexistent_LandUses[FLF,NE] = 1
Nonexistent_LandUses[FLF,CR] = 0
Nonexistent_LandUses[FLF,PA] = 0
Nonexistent_LandUses[FLF,FA] = 0
Nonexistent_LandUses[FLF,UR] = 0
Norm_T[LandCovers,LandUses] =
AmazonLand[LandCovers,LandUses]*Temp_in_C[LandCovers,LandUses]
Outgoing_Solar = ARRAYSUM(Land_cover_to_Atmosphere[*,*])
Regional_Temperature = ARRAYSUM(Norm_T[*,*])/ARRAYSUM(AmazonLand[*,*])
Specific_Heat_Water = 4218
Temp_in_C[LandCovers,LandUses] = (Temp_in_K[LandCovers,LandUses]-273)
Temp_in_K[LandCovers,LandUses] = IF Heat_Capacity[LandCovers,LandUses]=0 THEN 0 ELSE
Land_Cover_Energy[LandCovers,LandUses]/Heat_Capacity[LandCovers,LandUses]
•Albedo_Surface[AMF,NE] = 0.14
•Albedo_Surface[AMF,CR] = 0.19
•Albedo_Surface[AMF,PA] = 0.19
•Albedo_Surface[AMF,FA] = 0.14
•Albedo_Surface[AMF,UR] = 0.3
•Albedo_Surface[SAV,NE] = 0.14
•Albedo_Surface[SAV,CR] = 0.19
•Albedo_Surface[SAV,PA] = 0.19
•Albedo_Surface[SAV,FA] = 0.15
•Albedo_Surface[SAV,UR] = 0.30
•Albedo_Surface[RIV,NE] = 0.3
•Albedo_Surface[RIV,CR] = 0
•Albedo_Surface[RIV,PA] = 0
•Albedo_Surface[RIV,FA] = 0
•Albedo_Surface[RIV,UR] = 0
•Albedo_Surface[FLF,NE] = 0.3
•Albedo_Surface[FLF,CR] = 0
•Albedo_Surface[FLF,PA] = 0
•Albedo_Surface[FLF,FA] = 0
•Albedo_Surface[FLF,UR] = 0
•Boltzmann_k[LandCovers,LandUses] = 0.0000000567*31557600
•CO2_Abs_Calibration = 0.032
•ICAMENERGY[AMF,NE] = 6.22E11
•ICAMENERGY[AMF,CR] = 4E11
•ICAMENERGY[AMF,PA] = 2E11
•ICAMENERGY[AMF,FA] = 5E11
•ICAMENERGY[AMF,UR] = 4E11
•ICAMENERGY[SAV,NE] = 5E11
•ICAMENERGY[SAV,CR] = 5E11
•ICAMENERGY[SAV,PA] = 5E11
•ICAMENERGY[SAV,FA] = 5E11
•ICAMENERGY[SAV,UR] = 3E11
•ICAMENERGY[RIV,NE] = 6.22E11
•ICAMENERGY[RIV,CR] = 0

```

- ICAMENERGY[RIV,PA] = 0
- ICAMENERGY[RIV,FA] = 0
- ICAMENERGY[RIV,UR] = 0
- ICAMENERGY[FLF,NE] = 6.22E11
- ICAMENERGY[FLF,CR] = 0
- ICAMENERGY[FLF,PA] = 0
- ICAMENERGY[FLF,FA] = 0
- ICAMENERGY[FLF,UR] = 0
- Imperfect_Emissivity[LandCovers,LandUses] = 0.63
- LCLU_Heat_Capacity[AMF,NE] = 2E+15
- LCLU_Heat_Capacity[AMF,CR] = 1.7E+15
- LCLU_Heat_Capacity[AMF,PA] = 2.85E+15
- LCLU_Heat_Capacity[AMF,FA] = 3E+15
- LCLU_Heat_Capacity[AMF,UR] = 2.8E+15
- LCLU_Heat_Capacity[SAV,NE] = 3E+15
- LCLU_Heat_Capacity[SAV,CR] = 1.7E+15
- LCLU_Heat_Capacity[SAV,PA] = 2.85E+15
- LCLU_Heat_Capacity[SAV,FA] = 3E+15
- LCLU_Heat_Capacity[SAV,UR] = 2.8E+15
- LCLU_Heat_Capacity[RIV,NE] = 3.45E+15
- LCLU_Heat_Capacity[RIV,CR] = 0
- LCLU_Heat_Capacity[RIV,PA] = 0
- LCLU_Heat_Capacity[RIV,FA] = 0
- LCLU_Heat_Capacity[RIV,UR] = 0
- LCLU_Heat_Capacity[FLF,NE] = 3.45E+15
- LCLU_Heat_Capacity[FLF,CR] = 0
- LCLU_Heat_Capacity[FLF,PA] = 0
- LCLU_Heat_Capacity[FLF,FA] = 0
- LCLU_Heat_Capacity[FLF,UR] = 0
- Solar_Constant = 4.31708E+10 {J/m2/yr}

Bioavailable_IOC[LandCovers,LandUses] = GRAPH(TIME)
(1974, 327), (1975, 328), (1976, 330), (1977, 331), (1978, 332), (1979, 334), (1980, 335), (1981, 337),
(1982, 338), (1983, 340), (1984, 342), (1985, 343), (1986, 345), (1987, 347), (1988, 349), (1989, 351),
(1990, 353), (1991, 356), (1992, 358), (1993, 360), (1994, 363), (1995, 365), (1996, 368), (1997, 370),
(1998, 373), (1999, 376), (2000, 379), (2001, 382), (2002, 385), (2003, 388), (2004, 391), (2005, 394),
(2006, 398), (2007, 401), (2008, 404), (2009, 407), (2010, 411), (2011, 414), (2012, 417), (2013, 421),
(2014, 424), (2015, 427), (2016, 430), (2017, 434), (2018, 437), (2019, 440), (2020, 443), (2021, 446),
(2022, 449), (2023, 452), (2024, 455), (2025, 458), (2026, 461), (2027, 464), (2028, 467), (2029, 470),
(2030, 472), (2031, 475), (2032, 478), (2033, 480), (2034, 483), (2035, 485), (2036, 488), (2037, 490),
(2038, 493), (2039, 495), (2040, 497), (2041, 499), (2042, 502), (2043, 504), (2044, 506), (2045, 508),
(2046, 510), (2047, 512), (2048, 514), (2049, 516), (2050, 518), (2051, 520), (2052, 521), (2053, 523),
(2054, 525), (2055, 526), (2056, 528), (2057, 530), (2058, 531), (2059, 533), (2060, 534), (2061, 536),
(2062, 537), (2063, 538), (2064, 540), (2065, 541), (2066, 542), (2067, 544), (2068, 545), (2069, 546),
(2070, 547), (2071, 548), (2072, 549), (2073, 550), (2074, 552), (2075, 553), (2076, 554), (2077, 555),
(2078, 556), (2079, 557), (2080, 558), (2081, 559), (2082, 559), (2083, 560), (2084, 561), (2085, 562),
(2086, 563), (2087, 564), (2088, 565), (2089, 565), (2090, 566), (2091, 567), (2092, 568), (2093, 568),
(2094, 569), (2095, 570), (2096, 570), (2097, 571), (2098, 572), (2099, 572), (2100, 573)

H20WithinSectorAtmosphere
Array_sum = ARRAYSUM(•LCLU_Prec_Prob[*,*])
Cloud_water_Atlantic = 20.5
Precipitation[LandCovers,LandUses] = IF AmazonLand[LandCovers,LandUses] = 0 THEN 0 ELSE
(EvapoTranspiration[LandCovers,LandUses]/(AmazonLand[LandCovers,LandUses]*1E6)+Cloud_water_
Atlantic)*AmazonLand[LandCovers,LandUses]*1E6*•LCLU_Prec_Prob[LandCovers,LandUses]/(ARRA
YSUM(•LCLU_Prec_Prob[*,*]))

Total_Precipitable_Water = ARRAYSUM(Precipitation[AMF, *])+ARRAYSUM(Precipitation[SAV, *])+Precipitation[RIV,NE]+Precipitation[FLF,NE]

- LCLU_Prec_Prob[AMF,NE] = 0.5
- LCLU_Prec_Prob[AMF,CR] = 0.2
- LCLU_Prec_Prob[AMF,PA] = 0.2
- LCLU_Prec_Prob[AMF,FA] = 0.2
- LCLU_Prec_Prob[AMF,UR] = 0.1
- LCLU_Prec_Prob[SAV,NE] = 0.25
- LCLU_Prec_Prob[SAV,CR] = 0.15
- LCLU_Prec_Prob[SAV,PA] = 0.15
- LCLU_Prec_Prob[SAV,FA] = 0.15
- LCLU_Prec_Prob[SAV,UR] = 0.1
- LCLU_Prec_Prob[RIV,NE] = 0.3
- LCLU_Prec_Prob[RIV,CR] = 0
- LCLU_Prec_Prob[RIV,PA] = 0
- LCLU_Prec_Prob[RIV,FA] = 0
- LCLU_Prec_Prob[RIV,UR] = 0
- LCLU_Prec_Prob[FLF,NE] = 0.3
- LCLU_Prec_Prob[FLF,CR] = 0
- LCLU_Prec_Prob[FLF,PA] = 0
- LCLU_Prec_Prob[FLF,FA] = 0
- LCLU_Prec_Prob[FLF,UR] = 0

HumansWithinSectoranthroposphere

Amazon_Population(t) = Amazon_Population(t - dt) + (Human_Births + Net_Migration - Human_Deaths) * dt

INIT Amazon_Population = •IC_Human_Population

INFLOWS:

Human_Births = Fertility_Rate*Amazon_Population

Net_Migration = •Migrantion_Rate*Amazon_Population

OUTFLOWS:

Human_Deaths = Amazon_Population*Mortality_Rate

Knowledge(t) = Knowledge(t - dt) + (Knowledge_Formation - Knowledge_Loss) * dt

INIT Knowledge = •IC_Knowledge

INFLOWS:

Knowledge_Formation = GS_Knowledge_Formation

OUTFLOWS:

Knowledge_Loss = Knowledge*•Knowledge_Deterioration_Rate

Fertility_Decrease = (•Fertility_Know_Max-

•Fertility_Know_Max/EXP(•Knowledge_V_Fertility*Knowledge))

Fertility_Increase = Food_per_capita*•F_perC_V_Fertility

Fertility_Rate = Max(0,(Fertility_Increase-Fertility_Decrease))

Food_per_capita = IF Amazon_Population=0 THEN 0 ELSE (OM_Produced*0.1)/(Amazon_Population)

Knowledge_Per_Capita = IF Amazon_Population=0 THEN 0 ELSE Knowledge/Amazon_Population

Labor_Force = •Labor_Force_Particip_Rate*Amazon_Population

Mortality_Decrease = (•Max_Health_Care_Effect-

•Max_Health_Care_Effect/EXP(•Health_Care_Factor*Knowledge))

Mortality_from_Hunger = MAX (0,(•Food_Needs-Food_per_capita))*•Food_Av_Mort_Rate

Mortality_from_waste = MIN(•Waste_Carrying_Capacity,WASTE)/•Waste_Carrying_Capacity

Mortality_Increase = Mortality_from_waste+Mortality_from_Hunger

Mortality_Rate = ABS((Mortality_Increase-Mortality_Decrease))

•Fertility_Know_Max = 0.15

•Food_Av_Mort_Rate = 0.1

•Food_Needs = 0.20

- F_perC_V_Fertility = IF TIME< 2005 THEN 0.11 ELSE 0.10
- Health_Care_Factor = 0.001
- IC_Human_Population = 9604449.50/1E6 {1975, in millions}
- IC_Knowledge = (•IC_Human_Population*0.4*4)/10
- Knowledge_Deterioration_Rate = 0.25
- Knowledge_V_Fertility = 0.05
- Labor_Force_Particip_Rate = .45
- Max_Health_Care_Effect = 0.01
- Migrantion_Rate = 0.0045
- Waste_Carrying_Capacity = 50

HumansWithinSectorAnthroposphere 2

BUILT_CAPITAL(t) = BUILT_CAPITAL(t - dt) + (BC_Formation - BC_Dep_Waste_Prod) * dt
 INIT BUILT_CAPITAL = •IC_Built_Capital

INFLOWS:

BC_Formation = (BC_Ore+BC_Org_Matter)

OUTFLOWS:

BC_Dep_Waste_Prod = •BC_Depreciation_Rate*BUILT_CAPITAL/1e3

WASTE(t) = WASTE(t - dt) + (BC_Dep_Waste_Prod + Waste_from_consumption - Nat_Waste_Assimilation) * dt

INIT WASTE = •IC_waste

INFLOWS:

BC_Dep_Waste_Prod = •BC_Depreciation_Rate*BUILT_CAPITAL/1e3

Waste_from_consumption = (Ore_Waste+Org_Matter_Waste+Water_Waste)

OUTFLOWS:

Nat_Waste_Assimilation =

(MIN(WASTE,Waste_Assimilation_Rate*•Max_Waste_Assimilation_Potential))

BC_Ore = •Ore_Needs_Rate[Built]*GS_Built_Capital_Formation

BC_Org_Matter = GS_Built_Capital_Formation*•Org_Mat_Needs_Rate[Built]

BUILT_CAPITAL_PerCap = IF Amazon_Population=0 THEN 0 ELSE

BUILT_CAPITAL *1e3/Amazon_Population

Consumed_Org_Matter = MAX(0, ORG_MATTER-BC_Org_Matter)

GS_Natural_Capital_Form_Cal = 1

Ore_Waste = (ORE-BC_Ore)*0.1

Org_Matter_Waste = (Consumed_Org_Matter)*0.5

Waste_Assimilation_Potential =

(•Max_Waste_Assimilation_Potential+1/Nat_Waste_Assimilation*•Max_Waste_Assimilation_Potential)

Waste_Assimilation_Rate =

MAX(1,(•Min_Waste_Assimilation_Rate+(GS_Natural_Capital_Formation*•NCF_Effect_on_Waste)))

Waste_produced = BC_Dep_Waste_Prod+Waste_from_consumption

Water_Waste = Total_Water_Waste/1e6

•BC_Depreciation_Rate = 0.0001

•IC_Built_Capital = 500

•IC_waste = 10

•Max_Waste_Assimilation_Potential = 1000

•Min_Waste_Assimilation_Rate = 0.1

•NCF_Effect_on_Waste = .01

Land Use Changes Driver

Agricultural_Prices = •GRP_Effect_on_Agr_Prices*GRP_Growth

Exports_Growth = (Exports/2)

GRP_Growth = GRP/8

Imports_Growth = Imports/4

Initial_Urban_Area = IF Population_Density>Rural_Population_Density THEN 1 ELSE 0

$LCCR_AMF[LandUses, LandUses] = (\bullet LUC_F_Rural_Effect[LandUses, LandUses] * Rural_Population * 1e-5 + \bullet LUC_F_Urban_Effect[LandUses, LandUses] * Urban_Population * 1e-5 + \bullet LC_F_conversion[LandUses, LandUses] * GRP_Growth * 1e-5)$
 Living_Area =
 $LCOut_AMF[AMF, NE] + LCOut_AMF[AMF, CR] + LCOut_AMF[AMF, PA] + LCOut_AMF[AMF, FA] + LCOut_AMF[AMF, UR]$
 Market_Access = (Imports_Growth + Exports_Growth) / 100
 Non_Urban_Living_Area =
 $LCOut_AMF[AMF, NE] + LCOut_AMF[AMF, CR] + LCOut_AMF[AMF, PA] + LCOut_AMF[AMF, FA]$
 Population_Density = Amazon_Population / Living_Area
 Regional_per_capita_income = $\bullet GRP_Effect_on_income * GRP_Growth$
 Roads_Density = (BUILT_CAPITAL / Total_Amazon_Land) * 10
 Rural_Population = Amazon_Population * Rural_Pop_Change
 Rural_Population_Density = Rural_Population / Non_Urban_Living_Area
 Rural_Pop_Change =
 $(1 / (Market_Access + Roads_Density + Agricultural_Prices + Regional_per_capita_income)^{0.2}) / 3.5$
 Urban_Population = Amazon_Population * Urban_Pop_Change
 Urban_Pop_Change = 1 - Rural_Pop_Change
 Urban_Pop_Change_Data = 1 - Rural_Pop_Change_Data
 $\bullet GRP_Effect_on_Agr_Prices = 0.01$
 $\bullet GRP_Effect_on_income = 0.01$
 $\bullet LC_F_conversion[LandUses, LandUses] = 1e-5$
 $\bullet LUC_F_Rural_Effect[LandUses, LandUses] = 0$
 $\bullet LUC_F_Urban_Effect[LandUses, LandUses] = 0$
 Rural_Pop_Change_Data = GRAPH(TIME)
 (1970, 0.625), (1973, 0.58), (1976, 0.543), (1979, 0.503), (1982, 0.47), (1985, 0.441), (1988, 0.415), (1991, 0.393), (1994, 0.37), (1997, 0.348), (2000, 0.322)

NutrientsWithinSectorHydrosphere

$N_GROUND_WATER[LandCovers, LandUses](t) = N_GROUND_WATER[LandCovers, LandUses](t - dt) + (N_Net_Vert_Flux[LandCovers, LandUses] - Deep_N_to_biosphere[LandCovers, LandUses] - N_Deep_Sedimentation[LandCovers, LandUses]) * dt$

$INIT\ N_GROUND_WATER[LandCovers, LandUses] = \bullet IC_N_Deep_Water[LandCovers, LandUses]$

INFLOWS:

$N_Net_Vert_Flux[LandCovers, LandUses] =$

$\bullet N_Flux_Rate[LandCovers, LandUses] * (N_SURFACE_WATER[LandCovers, LandUses] - N_GROUND_WATER[LandCovers, LandUses])$

OUTFLOWS:

$Deep_N_to_biosphere[LandCovers, LandUses] =$

$Deep_BioX_C[LandCovers, LandUses] * N:C_Ratio_Above_Ground_Biomass[LandCovers, LandUses]$

$N_Deep_Sedimentation[LandCovers, LandUses] =$

$N_GROUND_WATER[LandCovers, LandUses] * \bullet N_Deep_C_Sedimentation_Rate[LandCovers, LandUses]$

$N_SURFACE_WATER[LandCovers, LandUses](t) = N_SURFACE_WATER[LandCovers, LandUses](t - dt) + (N_MinX_Atm[LandCovers, LandUses] - N_Net_Vert_Flux[LandCovers, LandUses] -$

$N_Sedimentation[LandCovers, LandUses] - Surface_N_Uptake[LandCovers, LandUses] -$

$N_Spatial_Exchange[LandCovers, LandUses]) * dt$

$INIT\ N_SURFACE_WATER[LandCovers, LandUses] = \bullet IC_N_Surface_Water[LandCovers, LandUses]$

INFLOWS:

$N_MinX_Atm[LandCovers, LandUses] = (\bullet Mineral_Deposition[LandCovers, LandUses] - Denitrification[LandCovers, LandUses]) * AmazonLand[LandCovers, LandUses]$

OUTFLOWS:

$N_Net_Vert_Flux[LandCovers, LandUses] =$

$\bullet N_Flux_Rate[LandCovers, LandUses] * (N_SURFACE_WATER[LandCovers, LandUses] - N_GROUND_WATER[LandCovers, LandUses])$

$N_{Sedimentation}[LandCovers, LandUses] =$
 • $N_{Shallow_Sedimentation_Rate}[LandCovers, LandUses] * N_{SURFACE_WATER}[LandCovers, LandUses]$
 $Surface_N_Uptake[LandCovers, LandUses] =$
 $BioX_C[LandCovers, LandUses] * N:C_Ratio_Above_Ground_Biomass[LandCovers, LandUses]$
 $N_{Spatial_Exchange}[LandCovers, LandUses] = IF SURFACE_WATER[LandCovers, LandUses] = 0 THEN$
 0 ELSE
 $Continental_Runoff[LandCovers, LandUses] / SURFACE_WATER[LandCovers, LandUses] * N_{SURFACE_WATER}[LandCovers, LandUses] - Andean_DIN[LandCovers, LandUses]$
 $Andean_DIN[LandCovers, LandUses] = 0$
 $Denitrification[LandCovers, LandUses] = 0.12$
 $Fresh_water_quality[LandCovers, LandUses] =$
 $N_{GROUND_WATER}[LandCovers, LandUses] + N_{SURFACE_WATER}[LandCovers, LandUses]$
 $Total_DIN_Discharge =$
 $N_{Spatial_Exchange}[AMF, NE] + N_{Spatial_Exchange}[AMF, CR] + N_{Spatial_Exchange}[AMF, PA] + N_{Spatial_Exchange}[AMF, FA] + N_{Spatial_Exchange}[AMF, UR] + N_{Spatial_Exchange}[SAV, NE] + N_{Spatial_Exchange}[SAV, CR] + N_{Spatial_Exchange}[SAV, PA] + N_{Spatial_Exchange}[SAV, FA] + N_{Spatial_Exchange}[SAV, UR] + N_{Spatial_Exchange}[RIV, NE] + N_{Spatial_Exchange}[FLF, NE]$
 • $Fertilizer_Production[LandCovers, LandUses] = 0$
 • $IC_N_Deep_Water[LandCovers, LandUses] = 100$
 • $IC_N_Surface_Water[LandCovers, LandUses] = 100$
 • $Mineral_Deposition[LandCovers, LandUses] = 0.3$
 • $N_{Deep_C_Sedimentation_Rate}[LandCovers, LandUses] = 0$
 • $N_{Flux_Rate}[AMF, NE] = 0$
 • $N_{Flux_Rate}[AMF, CR] = 0$
 • $N_{Flux_Rate}[AMF, PA] = 0$
 • $N_{Flux_Rate}[AMF, FA] = 0$
 • $N_{Flux_Rate}[AMF, UR] = 0$
 • $N_{Flux_Rate}[SAV, NE] = 0$
 • $N_{Flux_Rate}[SAV, CR] = 0$
 • $N_{Flux_Rate}[SAV, PA] = 0$
 • $N_{Flux_Rate}[SAV, FA] = 0$
 • $N_{Flux_Rate}[SAV, UR] = 0$
 • $N_{Flux_Rate}[RIV, NE] = 0.03$
 • $N_{Flux_Rate}[RIV, CR] = 0$
 • $N_{Flux_Rate}[RIV, PA] = 0$
 • $N_{Flux_Rate}[RIV, FA] = 0$
 • $N_{Flux_Rate}[RIV, UR] = 0$
 • $N_{Flux_Rate}[FLF, NE] = 0.04$
 • $N_{Flux_Rate}[FLF, CR] = 0$
 • $N_{Flux_Rate}[FLF, PA] = 0$
 • $N_{Flux_Rate}[FLF, FA] = 0$
 • $N_{Flux_Rate}[FLF, UR] = 0$
 • $N_{Shallow_Sedimentation_Rate}[AMF, NE] = 0$
 • $N_{Shallow_Sedimentation_Rate}[AMF, CR] = 0$
 • $N_{Shallow_Sedimentation_Rate}[AMF, PA] = 0$
 • $N_{Shallow_Sedimentation_Rate}[AMF, FA] = 0$
 • $N_{Shallow_Sedimentation_Rate}[AMF, UR] = 0$
 • $N_{Shallow_Sedimentation_Rate}[SAV, NE] = 0$
 • $N_{Shallow_Sedimentation_Rate}[SAV, CR] = 0$
 • $N_{Shallow_Sedimentation_Rate}[SAV, PA] = 0$
 • $N_{Shallow_Sedimentation_Rate}[SAV, FA] = 0$
 • $N_{Shallow_Sedimentation_Rate}[SAV, UR] = 0$
 • $N_{Shallow_Sedimentation_Rate}[RIV, NE] = 0.1$
 • $N_{Shallow_Sedimentation_Rate}[RIV, CR] = 0$
 • $N_{Shallow_Sedimentation_Rate}[RIV, PA] = 0$

- N_Shallow_Sedimentation_Rate[RIV,FA] = 0
- N_Shallow_Sedimentation_Rate[RIV,UR] = 0
- N_Shallow_Sedimentation_Rate[FLF,NE] = 0.3
- N_Shallow_Sedimentation_Rate[FLF,CR] = 0
- N_Shallow_Sedimentation_Rate[FLF,PA] = 0
- N_Shallow_Sedimentation_Rate[FLF,FA] = 0
- N_Shallow_Sedimentation_Rate[FLF,UR] = 0

NutrientsWithinSectorLithosphere

ROCK(t) = ROCK(t - dt) + (N_Burial_2 - Weathering_2 - ORE_Produced) * dt
 INIT ROCK = •IC_Ore

INFLOWS:

N_Burial_2 = ARRAYSUM(N_Burial[*,*])

OUTFLOWS:

Weathering_2 = ARRAYSUM(Weathering[*,*])

ORE_Produced = MIN(Minerable_Ore,Demand_Ore)

SOIL_CARBON[LandCovers,LandUses](t) = SOIL_CARBON[LandCovers,LandUses](t - dt) +
 (Organic_Matter[LandCovers,LandUses] - Soil_C_loss[LandCovers,LandUses]) * dt

INIT SOIL_CARBON[LandCovers,LandUses] = •IC_Soil_C[LandCovers,LandUses]

INFLOWS:

Organic_Matter[LandCovers,LandUses] = Org_Soil_Formation[LandCovers,LandUses]

OUTFLOWS:

Soil_C_loss[LandCovers,LandUses] =

•Soil_Respiration[LandCovers,LandUses]*SOIL_CARBON[LandCovers,LandUses]

SOIL_Nutrients[LandCovers,LandUses](t) = SOIL_Nutrients[LandCovers,LandUses](t - dt) +

(Fertilizer_applied[LandCovers,LandUses] + Bio_X_Atm[LandCovers,LandUses] -

Plant_N_Uptake[LandCovers,LandUses] - N_Burial[LandCovers,LandUses] -

Weathering[LandCovers,LandUses]) * dt

INIT SOIL_Nutrients[LandCovers,LandUses] = •IC_Soil_N[LandCovers,LandUses]

INFLOWS:

Fertilizer_applied[LandCovers,LandUses] = •Fertilizer_application_Rate[LandCovers,LandUses]

Bio_X_Atm[LandCovers,LandUses] =

(•N_Precipitation[LandCovers,LandUses]+•N_Fixation[LandCovers,LandUses]+•N_Throughfall[LandCovers,LandUses]-

(+•N_Denitrification[LandCovers,LandUses]+Nitrification[LandCovers,LandUses]))*AmazonLand[LandCovers,LandUses]

OUTFLOWS:

Plant_N_Uptake[LandCovers,LandUses] =

MAX(0,(GPP[LandCovers,LandUses])*NContent_of_Biomass[LandCovers,LandUses]/5.5)

N_Burial[LandCovers,LandUses] =

Rate_of_N_Burial[LandCovers,LandUses]*AmazonLand[LandCovers,LandUses]

Weathering[LandCovers,LandUses] = Weathering_Rate[LandCovers,LandUses]*ROCK

Minerable_Ore = 2e10

NContent_of_Biomass[LandCovers,LandUses] =

(Above_Ground_Biomass[LandCovers,LandUses]*•N_Fraction_Above_Ground_Biomass[LandCovers,LandUses]+Below_Ground_Biomass[LandCovers,LandUses]*•N_Fraction_Below_Ground_Biomass[LandCovers,LandUses])/(Above_Ground_Biomass[LandCovers,LandUses]+Below_Ground_Biomass[LandCovers,LandUses])

Nitrification[LandCovers,LandUses] = (1.5E-6*365)*1/100

Rate_of_N_Burial[LandCovers,LandUses] = 0

Soil_C_km2[LandCovers,LandUses] = IF AmazonLand[LandCovers,LandUses]=0 THEN 0 ELSE

SOIL_CARBON[LandCovers,LandUses]/AmazonLand[LandCovers,LandUses]

Soil_Loss_km2[LandCovers,LandUses] = IF AmazonLand[LandCovers,LandUses] = 0 THEN 0 ELSE

Soil_C_loss[LandCovers,LandUses]/AmazonLand[LandCovers,LandUses]

$\text{Soil_N_km2}[\text{LandCovers},\text{LandUses}] = \text{IF AmazonLand}[\text{LandCovers},\text{LandUses}] = 0 \text{ THEN } 0 \text{ ELSE}$
 $\text{SOIL_Nutrients}[\text{LandCovers},\text{LandUses}] / \text{AmazonLand}[\text{LandCovers},\text{LandUses}]$
 $\text{Weathering_Rate}[\text{LandCovers},\text{LandUses}] = 0$
 • $\text{Fertilizer_application_Rate}[\text{LandCovers},\text{LandUses}] = 0$
 • $\text{IC_Ore} = 2e10$
 • $\text{IC_Soil_C}[\text{AMF},\text{NE}] = \text{AmazonLand}[\text{AMF},\text{NE}] * 2200$
 • $\text{IC_Soil_C}[\text{AMF},\text{CR}] = \text{AmazonLand}[\text{AMF},\text{CR}] * 2400$
 • $\text{IC_Soil_C}[\text{AMF},\text{PA}] = \text{AmazonLand}[\text{AMF},\text{PA}] * 2660$
 • $\text{IC_Soil_C}[\text{AMF},\text{FA}] = \text{AmazonLand}[\text{AMF},\text{FA}] * 2050$
 • $\text{IC_Soil_C}[\text{AMF},\text{UR}] = \text{AmazonLand}[\text{AMF},\text{UR}] * 20$
 • $\text{IC_Soil_C}[\text{SAV},\text{NE}] = \text{AmazonLand}[\text{SAV},\text{NE}] * 2000$
 • $\text{IC_Soil_C}[\text{SAV},\text{CR}] = \text{AmazonLand}[\text{SAV},\text{CR}] * 2000$
 • $\text{IC_Soil_C}[\text{SAV},\text{PA}] = \text{AmazonLand}[\text{SAV},\text{PA}] * 2000$
 • $\text{IC_Soil_C}[\text{SAV},\text{FA}] = \text{AmazonLand}[\text{SAV},\text{FA}] * 1000$
 • $\text{IC_Soil_C}[\text{SAV},\text{UR}] = \text{AmazonLand}[\text{SAV},\text{UR}] * 20$
 • $\text{IC_Soil_C}[\text{RIV},\text{NE}] = \text{AmazonLand}[\text{RIV},\text{NE}] * 0$
 • $\text{IC_Soil_C}[\text{RIV},\text{CR}] = \text{AmazonLand}[\text{RIV},\text{CR}] * 0$
 • $\text{IC_Soil_C}[\text{RIV},\text{PA}] = \text{AmazonLand}[\text{RIV},\text{PA}] * 0$
 • $\text{IC_Soil_C}[\text{RIV},\text{FA}] = \text{AmazonLand}[\text{RIV},\text{FA}] * 0$
 • $\text{IC_Soil_C}[\text{RIV},\text{UR}] = \text{AmazonLand}[\text{RIV},\text{UR}] * 0$
 • $\text{IC_Soil_C}[\text{FLF},\text{NE}] = \text{AmazonLand}[\text{FLF},\text{NE}] * 2220$
 • $\text{IC_Soil_C}[\text{FLF},\text{CR}] = \text{AmazonLand}[\text{FLF},\text{CR}] * 2000$
 • $\text{IC_Soil_C}[\text{FLF},\text{PA}] = \text{AmazonLand}[\text{FLF},\text{PA}] * 2660$
 • $\text{IC_Soil_C}[\text{FLF},\text{FA}] = \text{AmazonLand}[\text{FLF},\text{FA}] * 2050$
 • $\text{IC_Soil_C}[\text{FLF},\text{UR}] = \text{AmazonLand}[\text{FLF},\text{UR}] * 20$
 • $\text{IC_Soil_N}[\text{LandCovers},\text{LandUses}] = \text{AmazonLand}[\text{LandCovers},\text{LandUses}] * 180$
 • $\text{N_Denitrification}[\text{LandCovers},\text{LandUses}] = 0.02$
 • $\text{N_Fixation}[\text{LandCovers},\text{LandUses}] = 2$
 • $\text{N_Precipitation}[\text{LandCovers},\text{LandUses}] = 0.6$
 • $\text{N_Throughfall}[\text{LandCovers},\text{LandUses}] = 0.6$
 • $\text{Soil_Respiration}[\text{AMF},\text{NE}] = 0.005$
 • $\text{Soil_Respiration}[\text{AMF},\text{CR}] = 0.25$
 • $\text{Soil_Respiration}[\text{AMF},\text{PA}] = 0.0015$
 • $\text{Soil_Respiration}[\text{AMF},\text{FA}] = 0.005$
 • $\text{Soil_Respiration}[\text{AMF},\text{UR}] = 0.005$
 • $\text{Soil_Respiration}[\text{SAV},\text{NE}] = 0.005$
 • $\text{Soil_Respiration}[\text{SAV},\text{CR}] = 0.005$
 • $\text{Soil_Respiration}[\text{SAV},\text{PA}] = 0.005$
 • $\text{Soil_Respiration}[\text{SAV},\text{FA}] = 0.005$
 • $\text{Soil_Respiration}[\text{SAV},\text{UR}] = 0.005$
 • $\text{Soil_Respiration}[\text{RIV},\text{NE}] = 0.005$
 • $\text{Soil_Respiration}[\text{RIV},\text{CR}] = 0.005$
 • $\text{Soil_Respiration}[\text{RIV},\text{PA}] = 0.005$
 • $\text{Soil_Respiration}[\text{RIV},\text{FA}] = 0.005$
 • $\text{Soil_Respiration}[\text{RIV},\text{UR}] = 0.005$
 • $\text{Soil_Respiration}[\text{FLF},\text{NE}] = 0.005$
 • $\text{Soil_Respiration}[\text{FLF},\text{CR}] = 0.005$
 • $\text{Soil_Respiration}[\text{FLF},\text{PA}] = 0.005$
 • $\text{Soil_Respiration}[\text{FLF},\text{FA}] = 0.005$
 • $\text{Soil_Respiration}[\text{FLF},\text{UR}] = 0.005$

NutrientWithinSectorAtmosphere
 $\text{Atmospheric_NOx}(t) = \text{Atmospheric_NOx}(t - dt) + (\text{Antropogenic_N} + \text{NOx_Boundary_X} - \text{NOx_Deposition}) * dt$
 $\text{INIT Atmospheric_NOx} = \bullet \text{IC_Atmos_N}$

INFLOWS:

Antropogenic_N = Total_Fire_Emissions

NOx_Boundary_X = 0

OUTFLOWS:

NOx_Deposition = Atmospheric_NOx*Deposit_Rate

Deposit_Rate = 0.1

Total_Fire_Emissions = ARRAYSUM(Fires[AMF, *])+ARRAYSUM(Fires[SAV, *])+ARRAYSUM(Fires[RIV, *])+ARRAYSUM(Fires[FLF, *])

•IC_Atmos_N = 0

ProductionWithinSectorAnthroposphere

GOODS_SERVICES(t) = GOODS_SERVICES(t - dt) + (GS_Econ_Prod - GS_Knowledge_Formation - GS_Built_Capital_Formation - GS_Social_Capital_Formation - GS_Personal_Consumption - GS_Natural_Capital_Formation - GS_Debt_Release) * dt

INIT GOODS_SERVICES = •IC_Goods_and_Services

INFLOWS:

GS_Econ_Prod =

(•Total_Factor_Productivity*EcoServices_Contribution*Labor_Contribution*EcoGoods_Contribution*Prod_reduction)

OUTFLOWS:

GS_Knowledge_Formation = IF Scenario_Switch=1 OR Scenario_Switch=3 THEN

Savings_Rate_Policies[Human]*GOODS_SERVICES ELSE

Saving_Rate_Assumptions[Human]*GOODS_SERVICES

GS_Built_Capital_Formation = IF Scenario_Switch=1 OR Scenario_Switch=3 THEN

Savings_Rate_Policies[Built]*GOODS_SERVICES ELSE

Saving_Rate_Assumptions[Built]*GOODS_SERVICES

GS_Social_Capital_Formation = IF Scenario_Switch=1 OR Scenario_Switch=3 THEN

Savings_Rate_Policies[Social]*GOODS_SERVICES ELSE

Saving_Rate_Assumptions[Social]*GOODS_SERVICES

GS_Personal_Consumption = IF Scenario_Switch=1 OR Scenario_Switch=3 THEN

Savings_Rate_Policies[Consump]*GOODS_SERVICES ELSE

Saving_Rate_Assumptions[Consump]*GOODS_SERVICES

GS_Natural_Capital_Formation = IF Scenario_Switch=1 OR Scenario_Switch=3 THEN

(Savings_Rate_Policies[Natural])*GOODS_SERVICES ELSE

Saving_Rate_Assumptions[Natural]*GOODS_SERVICES

GS_Debt_Release = IF Scenario_Switch=1 OR Scenario_Switch=3 THEN

Savings_Rate_Policies[Trade_Debt]*GOODS_SERVICES ELSE

Saving_Rate_Assumptions[Trade_Debt]*GOODS_SERVICES

Built_Cap_price = (•BC_Exp*GS_Econ_Prod)/BUILT_CAPITAL

Dev_Direction_Policy = IF Scenario_Switch=1 THEN 1 ELSE -1

Dev_Dir_Assumption = IF Scenario_Switch=2 THEN 1 ELSE -1

Dev_Effect_on_GRP = MIN(1,ABS(1-Devaluation_Events_and_rates))

EcoGoods_Contribution =

(ENERGY^•Energy_Exp*ORE^•Ore_Exp*ORG_MATTER^•OM_Exp*WATER^•WaterUse_Exp)

External_Investment[Capitals] = IF TIME < Time_Switch OR Scenario_Ass=0 THEN 0 ELSE

1*((•Saving_Rate[Capitals]+Dev_Dir_Assumption*(•Saving_Rate_Dev_Ass[Capitals]-

•Saving_Rate_Dev_Ass[Capitals]/EXP(•Switch_Rate*(TIME-

Dev_Dir_Assumption))))*GOODS_SERVICES

global_dimension = EcoServices_Contribution

GRP = IF Scenario_Switch=3 THEN

(Labor_Contribution*EcoGoods_Contribution+•Economic_Prod_intercept)*Dev_Effect_on_GRP+CARB

ON_PAYMENT*0 ELSE

(Labor_Contribution*EcoGoods_Contribution+•Economic_Prod_intercept)*Dev_Effect_on_GRP

GRP_CAPITA = IF Amazon_Population=0 THEN 0 ELSE GRP/Amazon_Population

GS_ECON_PROD_CAPITA = IF Amazon_Population=0 THEN 0 ELSE
 GS_Econ_Prod/Amazon_Population
 GS>Returns_to_scale =
 ARRAYSUM(•ES_Exp[*])+•BC_Exp+•Energy_Exp+•Know_Exp+•Labor_Exp+•OM_Exp+•Ore_Exp+•S
 C_Exp+•WaterUse_Exp+•Waste_Exp
 Knowledge_Price = (•Know_Exp*GS_Econ_Prod)/Knowledge
 Labor_Contribution =
 (BUILT_CAPITAL)^•BC_Exp*(Knowledge)^•Know_Exp*SOCIAL_NETWORK^•SC_Exp*Labor_Force
 ^•Labor_Exp
 Labour_Price = IF Labor_Force=0 THEN 0 ELSE (•Labor_Exp*GS_Econ_Prod)/Labor_Force
 Price_of_Energy = IF ENERGY=0 THEN 0 ELSE (•Energy_Exp*GS_Econ_Prod)/ENERGY
 Price_of_Ore = IF ORE=0 THEN 0 ELSE (•Ore_Exp*GS_Econ_Prod)/ORE
 Price_of_Organic_Matter = IF ORG_MATTER=0 THEN 0 ELSE
 (•OM_Exp*GS_Econ_Prod)/ORG_MATTER
 Price_of_Water = IF WATER=0 THEN 0 ELSE (•WaterUse_Exp*GS_Econ_Prod/WATER){ replace with
 portion of water use creating goods and services}
 Prod_reduction = Min(1,WASTE^•Waste_Exp)
 Savings_Rate_Policies[Capitals] = IF TIME < Time_Switch THEN •Saving_Rate[Capitals] ELSE
 •Saving_Rate[Capitals]+Dev_Direction_Policy*(•Saving_Rate_Dev_Pol[Capitals]-
 •Saving_Rate_Dev_Pol[Capitals]/EXP(•Switch_Rate*(TIME-Dev_Direction_Policy)))
 Saving_Rate_Assumptions[Capitals] = IF TIME < Time_Switch THEN •Saving_Rate[Capitals] ELSE
 •Saving_Rate[Capitals]+Dev_Dir_Assumption*(•Saving_Rate_Dev_Ass[Capitals]-
 •Saving_Rate_Dev_Ass[Capitals]/EXP(•Switch_Rate*(TIME-Dev_Dir_Assumption)))
 Scenario_Ass = IF Scenario_Switch=2 OR Scenario_Switch=4 THEN 1 ELSE 0
 Scenario_Switch = 1
 Social_Cap_Price = IF SOCIAL_NETWORK=0 THEN 0 ELSE
 (•SC_Exp*GS_Econ_Prod)/SOCIAL_NETWORK
 Time_Switch = 2100
 •BC_Exp = .1
 •Economic_Prod_intercept = 1
 •Energy_Exp = 0.4
 •IC_Goods_and_Services = 10
 •Know_Exp = 0.3
 •Labor_Exp = .3
 •OM_Exp = .07
 •Ore_Exp = .05
 •Saving_Rate[Human] = 0.005
 •Saving_Rate[Social] = 0.1
 •Saving_Rate[Built] = 0.3
 •Saving_Rate[Natural] = 0.2
 •Saving_Rate[Consump] = 0.5
 •Saving_Rate[Trade_Debt] = 0.1
 •Saving_Rate_Dev_Ass[Human] = 0.06
 •Saving_Rate_Dev_Ass[Social] = 0.2
 •Saving_Rate_Dev_Ass[Built] = 0.05
 •Saving_Rate_Dev_Ass[Natural] = 0.005
 •Saving_Rate_Dev_Ass[Consump] = 0
 •Saving_Rate_Dev_Ass[Trade_Debt] = 0
 •Saving_Rate_Dev_Pol[Human] = 0.06
 •Saving_Rate_Dev_Pol[Social] = 0.2
 •Saving_Rate_Dev_Pol[Built] = 0.05
 •Saving_Rate_Dev_Pol[Natural] = 0.005
 •Saving_Rate_Dev_Pol[Consump] = 0
 •Saving_Rate_Dev_Pol[Trade_Debt] = 0
 •SC_Exp = .03
 •Switch_Rate = 0.1

•Total_Factor_Productivity = 2.5

•Waste_Exp = 0

•WaterUse_Exp = 0.03

CARBON_PAYMENT = GRAPH(TIME)

(2005, 0.3), (2006, 0.63), (2007, 0.96), (2008, 1.29), (2009, 1.62), (2010, 1.95), (2011, 2.30), (2012, 2.65), (2013, 3.01), (2014, 3.38), (2015, 3.77), (2016, 4.17), (2017, 4.58), (2018, 5.00), (2019, 5.44), (2020, 5.88), (2021, 6.34), (2022, 6.80), (2023, 7.28), (2024, 7.76), (2025, 8.25), (2026, 8.75), (2027, 9.26), (2028, 9.77), (2029, 10.3), (2030, 10.8), (2031, 11.3), (2032, 11.8), (2033, 12.4), (2034, 12.9), (2035, 13.4), (2036, 14.0), (2037, 14.5), (2038, 15.0), (2039, 15.5), (2040, 16.1), (2041, 16.6), (2042, 17.1), (2043, 17.6), (2044, 18.1), (2045, 18.6), (2046, 19.1), (2047, 19.6), (2048, 20.0), (2049, 20.5), (2050, 20.9), (2051, 21.4), (2052, 21.8), (2053, 22.2), (2054, 22.7), (2055, 23.1), (2056, 23.5), (2057, 23.9), (2058, 24.2), (2059, 24.6), (2060, 25.0), (2061, 25.3), (2062, 25.6), (2063, 26.0), (2064, 26.3), (2065, 26.6), (2066, 26.9), (2067, 27.1), (2068, 27.4), (2069, 27.6), (2070, 27.9), (2071, 28.1), (2072, 28.3), (2073, 28.5), (2074, 28.7), (2075, 28.9), (2076, 29.1), (2077, 29.2), (2078, 29.4), (2079, 29.5), (2080, 29.6), (2081, 29.8), (2082, 29.9), (2083, 29.9), (2084, 30.0), (2085, 30.1), (2086, 30.2), (2087, 30.2), (2088, 30.3), (2089, 30.3), (2090, 30.4), (2091, 30.4), (2092, 30.4), (2093, 30.4)

ResourcesWithinSectorAnthroposphere

Demand_Energy =

((GS_Built_Capital_Formation+External_Investment[Built])*Energy_Needs_Rate[Built]+GS_Knowledge_Formation*Energy_Needs_Rate[Human]+(GS_Natural_Capital_Formation+External_Investment[Natural])*Energy_Needs_Rate[Natural]+GS_Personal_Consumption*Energy_Needs_Rate[Consump]+GS_Social_Capital_Formation*Energy_Needs_Rate[Social]+GS_Debt_Release*Energy_Needs_Rate[Trade_Debt])

Demand_for_Autotrophs[LandCovers,LandUses] =

•Autotroph_Harvest_Ratio[LandCovers,LandUses]*Demand_Org_Matter

Demand_for_Consumers[LandCovers,LandUses] = (MIN(0.1, (1-

•Autotroph_Harvest_Ratio[LandCovers,LandUses]))*

(Demand_Org_Matter))

Demand_for_energy_Import = MAX(0,Demand_Energy-Energy_Produced)

Demand_for_OM_Import = MAX(0,(Demand_Org_Matter-OM_Produced))

Demand_for_Ore_imports = MAX(0,Demand_Ore-ORE_Produced)

Demand_for_watet_import = -MIN(0,Water_Produced-Demand_Water)

Demand_Ore = ((GS_Built_Capital_Formation+External_Investment[Built])*Ore_Needs_Rate[Built]+

GS_Knowledge_Formation*Ore_Needs_Rate[Human]+

(GS_Natural_Capital_Formation+External_Investment[Natural])*Ore_Needs_Rate[Natural]+

GS_Social_Capital_Formation*Ore_Needs_Rate[Social]+

GS_Personal_Consumption*Ore_Needs_Rate[Consump]+GS_Debt_Release*Ore_Needs_Rate[Trade_Debt])

Demand_Org_Matter =

((GS_Built_Capital_Formation+External_Investment[Built])*Org_Mat_Needs_Rate[Built] +

GS_Knowledge_Formation*Org_Mat_Needs_Rate[Human]+

(GS_Natural_Capital_Formation+External_Investment[Natural])*Org_Mat_needs_Rate[Natural]+

GS_Social_Capital_Formation*Org_Mat_Needs_Rate[Social]+

GS_Personal_Consumption*Org_Mat_Needs_Rate[Consump]+GS_Debt_Release*Org_Mat_Needs_Rate[Trade_Debt])

Demand_Water =

((GS_Built_Capital_Formation+External_Investment[Built])*Water_Needs_Rate[Built]+GS_Knowledge_Formation*Water_Needs_Rate[Human]+(GS_Natural_Capital_Formation+External_Investment[Natural])

*Water_Needs_Rate[Natural]+GS_Personal_Consumption*Water_Needs_Rate[Consump]+GS_Social_Capital_Formation*Water_Needs_Rate[Social]*GS_Debt_Release*Water_Needs_Rate[Trade_Debt])

ENERGY = Energy_Produced+(MIN(Demand_for_energy_Import,Fossil_Fuels_available_from_Import))

Energy_Produced = 0.25*Demand_Energy

Fossil_Fuels_Imported = ENERGY-Energy_Produced

Imported_Ore = MIN(Demand_for_Ore_imports,Ore_Avail_from_Imports)

Imported_Water = MAX(Demand_for_watet_import,Water_available_from_Import)

LCLU_Auto_Harv[LandCovers,LandUses] =
 Demand_for_Autotrophs[LandCovers,LandUses]*•LU_AH_Distr[LandCovers,LandUses]
 LCLU_Cons_Harv[LandCovers,LandUses] =
 Demand_for_Consumers[LandCovers,LandUses]*•LU_CH_Distr[LandCovers,LandUses]
 OM_imported = MIN(Demand_for_OM_Import,Organic_Matter_available_from_Import)
 ORE = Imported_Ore+ORE_Produced
 ORG_MATTER = OM_imported+OM_Produced
 WATER = MIN(Demand_Water,(Water_Produced+Imported_Water))
 •Autotroph_Harvest_Ratio[LandCovers,LandUses] = 0
 •Energy_Needs_Rate[Capitals] = 0.1
 •LU_AH_Distr[AMF,NE] = IF Below_&_Above_Biomass[AMF,NE] = 0 THEN 0 ELSE
 Below_&_Above_Biomass[AMF,NE]/ARRAYSUM(Below_&_Above_Biomass[AMF, *])
 •LU_AH_Distr[AMF,CR] = IF Below_&_Above_Biomass[AMF,CR] = 0 THEN 0 ELSE
 Below_&_Above_Biomass[AMF,CR]/ARRAYSUM(Below_&_Above_Biomass[AMF, *])
 •LU_AH_Distr[AMF,PA] = IF Below_&_Above_Biomass[AMF,PA] = 0 THEN 0 ELSE
 Below_&_Above_Biomass[AMF,PA]/ARRAYSUM(Below_&_Above_Biomass[AMF, *])
 •LU_AH_Distr[AMF,FA] = IF Below_&_Above_Biomass[AMF,FA] = 0 THEN 0 ELSE
 Below_&_Above_Biomass[AMF,FA]/ARRAYSUM(Below_&_Above_Biomass[AMF, *])
 •LU_AH_Distr[AMF,UR] = IF Below_&_Above_Biomass[AMF,UR] = 0 THEN 0 ELSE
 Below_&_Above_Biomass[AMF,UR]/ARRAYSUM(Below_&_Above_Biomass[AMF, *])
 •LU_AH_Distr[SAV,NE] = IF Below_&_Above_Biomass[SAV,NE] = 0 THEN 0 ELSE
 Below_&_Above_Biomass[SAV,NE]/ARRAYSUM(Below_&_Above_Biomass[SAV, *])
 •LU_AH_Distr[SAV,CR] = IF Below_&_Above_Biomass[SAV,CR] = 0 THEN 0 ELSE
 Below_&_Above_Biomass[SAV,CR]/ARRAYSUM(Below_&_Above_Biomass[SAV, *])
 •LU_AH_Distr[SAV,PA] = IF Below_&_Above_Biomass[SAV,PA] = 0 THEN 0 ELSE
 Below_&_Above_Biomass[SAV,PA]/ARRAYSUM(Below_&_Above_Biomass[SAV, *])
 •LU_AH_Distr[SAV,FA] = IF Below_&_Above_Biomass[SAV,FA] = 0 THEN 0 ELSE
 Below_&_Above_Biomass[SAV,FA]/ARRAYSUM(Below_&_Above_Biomass[SAV, *])
 •LU_AH_Distr[SAV,UR] = IF Below_&_Above_Biomass[SAV,UR] = 0 THEN 0 ELSE
 Below_&_Above_Biomass[SAV,UR]/ARRAYSUM(Below_&_Above_Biomass[SAV, *])
 •LU_AH_Distr[RIV,NE] = IF Below_&_Above_Biomass[RIV,NE] = 0 THEN 0 ELSE
 Below_&_Above_Biomass[RIV,NE]/ARRAYSUM(Below_&_Above_Biomass[RIV, *])
 •LU_AH_Distr[RIV,CR] = IF Below_&_Above_Biomass[RIV,CR] = 0 THEN 0 ELSE
 Below_&_Above_Biomass[RIV,CR]/ARRAYSUM(Below_&_Above_Biomass[RIV, *])
 •LU_AH_Distr[RIV,PA] = IF Below_&_Above_Biomass[RIV,PA] = 0 THEN 0 ELSE
 Below_&_Above_Biomass[RIV,PA]/ARRAYSUM(Below_&_Above_Biomass[RIV, *])
 •LU_AH_Distr[RIV,FA] = IF Below_&_Above_Biomass[RIV,FA] = 0 THEN 0 ELSE
 Below_&_Above_Biomass[RIV,FA]/ARRAYSUM(Below_&_Above_Biomass[RIV, *])
 •LU_AH_Distr[RIV,UR] = IF Below_&_Above_Biomass[RIV,UR] = 0 THEN 0 ELSE
 Below_&_Above_Biomass[RIV,UR]/ARRAYSUM(Below_&_Above_Biomass[RIV, *])
 •LU_AH_Distr[FLF,NE] = IF Below_&_Above_Biomass[FLF,NE] = 0 THEN 0 ELSE
 Below_&_Above_Biomass[FLF,NE]/ARRAYSUM(Below_&_Above_Biomass[FLF, *])
 •LU_AH_Distr[FLF,CR] = IF Below_&_Above_Biomass[FLF,CR] = 0 THEN 0 ELSE
 Below_&_Above_Biomass[FLF,CR]/ARRAYSUM(Below_&_Above_Biomass[FLF, *])
 •LU_AH_Distr[FLF,PA] = IF Below_&_Above_Biomass[FLF,PA] = 0 THEN 0 ELSE
 Below_&_Above_Biomass[FLF,PA]/ARRAYSUM(Below_&_Above_Biomass[FLF, *])
 •LU_AH_Distr[FLF,FA] = IF Below_&_Above_Biomass[FLF,FA] = 0 THEN 0 ELSE
 Below_&_Above_Biomass[FLF,FA]/ARRAYSUM(Below_&_Above_Biomass[FLF, *])
 •LU_AH_Distr[FLF,UR] = IF Below_&_Above_Biomass[FLF,UR] = 0 THEN 0 ELSE
 Below_&_Above_Biomass[FLF,UR]/ARRAYSUM(Below_&_Above_Biomass[FLF, *])
 •LU_CH_Distr[LandCovers,LandUses] = •LU_AH_Distr[LandCovers,LandUses]
 •Ore_Needs_Rate[Human] = 0.1
 •Ore_Needs_Rate[Social] = 0.1
 •Ore_Needs_Rate[Built] = 0.5
 •Ore_Needs_Rate[Natural] = 0.1
 •Ore_Needs_Rate[Consump] = 0.2

- Ore_Needs_Rate[Trade_Debt] = 0.1
- Org_Mat_Needs_Rate[Human] = 0.1
- Org_Mat_Needs_Rate[Social] = 0.1
- Org_Mat_Needs_Rate[Built] = 0.5
- Org_Mat_Needs_Rate[Natural] = 0.1
- Org_Mat_Needs_Rate[Consump] = 0.2
- Org_Mat_Needs_Rate[Trade_Debt] = 0.1
- Water_Needs_Rate[Human] = 0.1
- Water_Needs_Rate[Social] = 0.01
- Water_Needs_Rate[Built] = 0.2
- Water_Needs_Rate[Natural] = 0.2
- Water_Needs_Rate[Consump] = 0.1
- Water_Needs_Rate[Trade_Debt] = 0

Energy_Data = GRAPH(TIME)
(1970, 5.49), (1980, 9.69), (1990, 14.6), (2000, 21.3)

Energy_Needed = GRAPH(TIME)
(1970, 5.50), (2002, 21.5), (2035, 43.0), (2068, 72.5), (2100, 97.5)

Fossil_Fuels_available_from_Import = GRAPH(Global_Price_on_Energy)
(10.0, 100), (19.0, 95.0), (28.0, 90.0), (37.0, 84.5), (46.0, 80.0), (55.0, 75.0), (64.0, 70.0), (73.0, 65.0),
(82.0, 60.0), (91.0, 55.0), (100, 50.0)

Global_Price_on_Energy = GRAPH(TIME)
(1974, 11.7), (1975, 11.8), (1976, 11.9), (1977, 12.1), (1978, 12.2), (1979, 12.3), (1980, 12.5), (1981, 12.6),
(1982, 12.8), (1983, 12.9), (1984, 13.1), (1985, 13.3), (1986, 13.4), (1987, 13.6), (1988, 13.8), (1989, 14.0),
(1990, 14.2), (1991, 14.4), (1992, 14.6), (1993, 14.8), (1994, 15.0), (1995, 15.2), (1996, 15.5), (1997, 15.7),
(1998, 16.0), (1999, 16.2), (2000, 16.5), (2001, 16.7), (2002, 17.0), (2003, 17.3), (2004, 17.6), (2005, 17.9),
(2006, 18.2), (2007, 18.5), (2008, 18.9), (2009, 19.2), (2010, 19.5), (2011, 19.9), (2012, 20.3), (2013, 20.6),
(2014, 21.0), (2015, 21.4), (2016, 21.8), (2017, 22.2), (2018, 22.6), (2019, 23.1), (2020, 23.5), (2021, 23.9),
(2022, 24.4), (2023, 24.9), (2024, 25.4), (2025, 25.9), (2026, 26.4), (2027, 26.9), (2028, 27.4), (2029, 28.0),
(2030, 28.5), (2031, 29.1), (2032, 29.9), (2033, 30.5), (2034, 31.1), (2035, 31.8), (2036, 32.5), (2037, 33.1),
(2038, 33.8), (2039, 34.5), (2040, 35.3), (2041, 36.0), (2042, 36.8), (2043, 37.6), (2044, 38.3), (2045, 39.1),
(2046, 40.0), (2047, 40.8), (2048, 41.6), (2049, 42.4), (2050, 43.2), (2051, 44.1), (2052, 44.9), (2053, 45.7),
(2054, 46.5), (2055, 47.3), (2056, 48.1), (2057, 48.9), (2058, 49.6), (2059, 50.4), (2060, 51.1), (2061, 51.7),
(2062, 52.4), (2063, 53.0), (2064, 53.5), (2065, 54.1), (2066, 54.6), (2067, 55.0), (2068, 55.5), (2069, 55.9),
(2070, 56.2), (2071, 56.5), (2072, 56.8), (2073, 57.1), (2074, 57.3), (2075, 57.5), (2076, 57.6), (2077, 57.7),
(2078, 57.9), (2079, 57.9), (2080, 58.0), (2081, 58.0), (2082, 58.1), (2083, 58.1), (2084, 58.1), (2085, 58.1),
(2086, 58.0), (2087, 58.0), (2088, 58.0), (2089, 57.9), (2090, 57.9), (2091, 57.8), (2092, 57.8), (2093, 57.7),
(2094, 57.7), (2095, 57.6), (2096, 57.5), (2097, 57.5), (2098, 57.5), (2099, 57.4), (2100, 57.3)

Global_Price_on_OM = GRAPH(TIME)
(1974, 29.4), (1975, 29.4), (1976, 29.4), (1977, 29.5), (1978, 29.5), (1979, 29.5), (1980, 29.5), (1981, 29.5),
(1982, 29.4), (1983, 29.4), (1984, 29.3), (1985, 29.3), (1986, 29.2), (1987, 29.1), (1988, 29.0), (1989, 28.9),
(1990, 28.9), (1991, 28.8), (1992, 28.6), (1993, 28.5), (1994, 28.4), (1995, 28.3), (1996, 28.2), (1997, 28.1),
(1998, 28.0), (1999, 27.9), (2000, 27.9), (2001, 27.8), (2002, 27.7), (2003, 27.7), (2004, 27.7), (2005, 27.6),
(2006, 27.6), (2007, 27.6), (2008, 27.7), (2009, 27.7), (2010, 27.8), (2011, 27.8), (2012, 27.9), (2013, 28.0),
(2014, 28.1), (2015, 28.3), (2016, 28.4), (2017, 28.6), (2018, 28.8), (2019, 29.0), (2020, 29.2), (2021, 29.4),
(2022, 29.6), (2023, 29.9), (2024, 30.1), (2025, 30.4), (2026, 30.7), (2027, 31.0), (2028, 31.3), (2029, 31.6),
(2030, 32.0), (2031, 32.3), (2032, 32.9), (2033, 33.3), (2034, 33.7), (2035, 34.0), (2036, 34.4), (2037, 34.8),
(2038, 35.2), (2039, 35.6), (2040, 36.1), (2041, 36.5), (2042, 36.9), (2043, 37.4), (2044, 37.8), (2045, 38.2),
(2046, 38.6), (2047, 39.1), (2048, 39.5), (2049, 40.0), (2050, 40.4), (2051, 40.9), (2052, 41.3), (2053, 41.7),
(2054, 42.1), (2055, 42.5), (2056, 43.0), (2057, 43.4), (2058, 43.7), (2059, 44.1), (2060, 44.5), (2061, 44.8),
(2062, 45.1), (2063, 45.4), (2064, 45.7), (2065, 45.9), (2066, 46.2), (2067, 46.4), (2068, 46.6), (2069, 46.8),
(2070, 46.9), (2071, 47.1), (2072, 47.2), (2073, 47.3), (2074, 47.4), (2075, 47.5), (2076, 47.5), (2077, 47.6),
(2078, 47.6), (2079, 47.6), (2080, 47.6), (2081, 47.6), (2082, 47.6), (2083, 47.6), (2084, 47.6), (2085, 47.6),
(2086, 47.6), (2087, 47.5), (2088, 47.5), (2089, 47.5), (2090, 47.5), (2091, 47.4), (2092, 47.4), (2093, 47.4),
(2094, 47.3), (2095, 47.3), (2096, 47.3), (2097, 47.3), (2098, 47.2), (2099, 47.2), (2100, 47.2)

Global_Price_on_Ore = GRAPH(TIME)

(1974, 0.03), (1975, 0.03), (1976, 0.03), (1977, 0.03), (1978, 0.03), (1979, 0.03), (1980, 0.03), (1981, 0.03), (1982, 0.03), (1983, 0.03), (1984, 0.03), (1985, 0.03), (1986, 0.03), (1987, 0.03), (1988, 0.03), (1989, 0.03), (1990, 0.03), (1991, 0.03), (1992, 0.03), (1993, 0.03), (1994, 0.03), (1995, 0.03), (1996, 0.03), (1997, 0.03), (1998, 0.03), (1999, 0.03), (2000, 0.03), (2001, 0.03), (2002, 0.03), (2003, 0.03), (2004, 0.03), (2005, 0.03), (2006, 0.03), (2007, 0.03), (2008, 0.03), (2009, 0.03), (2010, 0.03), (2011, 0.03), (2012, 0.03), (2013, 0.03), (2014, 0.03), (2015, 0.03), (2016, 0.03), (2017, 0.03), (2018, 0.03), (2019, 0.03), (2020, 0.03), (2021, 0.03), (2022, 0.03), (2023, 0.03), (2024, 0.03), (2025, 0.03), (2026, 0.03), (2027, 0.03), (2028, 0.03), (2029, 0.03), (2030, 0.03), (2031, 0.03), (2032, 0.03), (2033, 0.03), (2034, 0.03), (2035, 0.03), (2036, 0.03), (2037, 0.03), (2038, 0.02), (2039, 0.02), (2040, 0.02), (2041, 0.02), (2042, 0.02), (2043, 0.02), (2044, 0.02), (2045, 0.02), (2046, 0.02), (2047, 0.02), (2048, 0.02), (2049, 0.02), (2050, 0.02), (2051, 0.02), (2052, 0.02), (2053, 0.02), (2054, 0.02), (2055, 0.02), (2056, 0.02), (2057, 0.02), (2058, 0.02), (2059, 0.02), (2060, 0.02), (2061, 0.02), (2062, 0.02), (2063, 0.02), (2064, 0.02), (2065, 0.02), (2066, 0.02), (2067, 0.02), (2068, 0.02), (2069, 0.02), (2070, 0.02), (2071, 0.02), (2072, 0.02), (2073, 0.02), (2074, 0.02), (2075, 0.02), (2076, 0.02), (2077, 0.02), (2078, 0.02), (2079, 0.02), (2080, 0.02), (2081, 0.02), (2082, 0.02), (2083, 0.02), (2084, 0.02), (2085, 0.02), (2086, 0.02), (2087, 0.02), (2088, 0.02), (2089, 0.02), (2090, 0.02), (2091, 0.02), (2092, 0.02), (2093, 0.02), (2094, 0.02), (2095, 0.02), (2096, 0.02), (2097, 0.02), (2098, 0.02), (2099, 0.02), (2100, 0.02)

Global_Price_on_Water = GRAPH(TIME)

(1974, 3.10), (1975, 3.10), (1976, 3.10), (1977, 3.10), (1978, 3.10), (1979, 3.10), (1980, 3.10), (1981, 3.10), (1982, 3.10), (1983, 3.10), (1984, 3.09), (1985, 3.09), (1986, 3.09), (1987, 3.09), (1988, 3.09), (1989, 3.09), (1990, 3.09), (1991, 3.09), (1992, 3.09), (1993, 3.09), (1994, 3.08), (1995, 3.08), (1996, 3.08), (1997, 3.08), (1998, 3.08), (1999, 3.08), (2000, 3.08), (2001, 3.07), (2002, 3.07), (2003, 3.07), (2004, 3.07), (2005, 3.07), (2006, 3.06), (2007, 3.06), (2008, 3.06), (2009, 3.06), (2010, 3.05), (2011, 3.05), (2012, 3.05), (2013, 3.05), (2014, 3.04), (2015, 3.04), (2016, 3.04), (2017, 3.03), (2018, 3.03), (2019, 3.03), (2020, 3.02), (2021, 3.02), (2022, 3.01), (2023, 3.01), (2024, 3.01), (2025, 3.00), (2026, 3.00), (2027, 2.99), (2028, 2.99), (2029, 2.99), (2030, 2.98), (2031, 2.98), (2032, 2.98), (2033, 2.98), (2034, 2.97), (2035, 2.96), (2036, 2.96), (2037, 2.95), (2038, 2.95), (2039, 2.95), (2040, 2.94), (2041, 2.94), (2042, 2.94), (2043, 2.93), (2044, 2.93), (2045, 2.93), (2046, 2.92), (2047, 2.92), (2048, 2.92), (2049, 2.92), (2050, 2.92), (2051, 2.91), (2052, 2.91), (2053, 2.91), (2054, 2.91), (2055, 2.91), (2056, 2.91), (2057, 2.91), (2058, 2.91), (2059, 2.91), (2060, 2.91), (2061, 2.91), (2062, 2.92), (2063, 2.92), (2064, 2.92), (2065, 2.92), (2066, 2.92), (2067, 2.92), (2068, 2.93), (2069, 2.93), (2070, 2.93), (2071, 2.93), (2072, 2.94), (2073, 2.94), (2074, 2.94), (2075, 2.94), (2076, 2.95), (2077, 2.95), (2078, 2.95), (2079, 2.95), (2080, 2.96), (2081, 2.96), (2082, 2.96), (2083, 2.96), (2084, 2.96), (2085, 2.97), (2086, 2.97), (2087, 2.97), (2088, 2.97), (2089, 2.97), (2090, 2.97), (2091, 2.97), (2092, 2.98), (2093, 2.98), (2094, 2.98), (2095, 2.98), (2096, 2.98), (2097, 2.98), (2098, 2.98), (2099, 2.98), (2100, 2.98)

Ore_Avail_from_Imports = GRAPH(Global_Price_on_Ore)

(0.00, 100), (0.1, 75.0), (0.2, 49.0), (0.3, 30.5), (0.4, 19.5), (0.5, 14.5), (0.6, 9.50), (0.7, 7.00), (0.8, 5.00), (0.9, 2.50), (1, 2.50)

Organic_Matter_available_from_Import = GRAPH(Global_Price_on_OM)

(0.00, 100), (5.00, 75.0), (10.0, 49.0), (15.0, 30.5), (20.0, 19.5), (25.0, 14.5), (30.0, 9.50), (35.0, 7.00), (40.0, 5.00), (45.0, 2.50), (50.0, 2.50)

Organic_Matter_Data = GRAPH(TIME)

(1970, 2.80), (1980, 3.70), (1990, 5.80), (2000, 7.20)

Water_available_from_Import = GRAPH((Global_Price_on_Water))

(0.00, 100), (0.5, 75.0), (1.00, 49.0), (1.50, 30.5), (2.00, 19.5), (2.50, 14.5), (3.00, 9.50), (3.50, 7.00), (4.00, 5.00), (4.50, 2.50), (5.00, 2.50)

Water_Data = GRAPH(TIME)

(1970, 0.45), (1980, 0.6), (1990, 0.93), (2000, 1.15)

Sector 2

C_GROUND_WATER[LandCovers, LandUses](t) = C_GROUND_WATER[LandCovers, LandUses](t - dt)
+ (- C_Net_Vertical_flux[LandCovers, LandUses] - Deep_BioX_C[LandCovers, LandUses] -
Deep_C_sedimentation[LandCovers, LandUses]) * dt

INIT C_GROUND_WATER[LandCovers, LandUses] = •IC_C_Deep_Water[LandCovers, LandUses]

OUTFLOWS:

C_Net_Vertical_flux[LandCovers, LandUses] =

•C_Vert_Flux_Rate[LandCovers, LandUses]*C_GROUND_WATER[LandCovers, LandUses]

Deep_BioX_C[LandCovers,LandUses] =
 (Consumer_Resp[LandCovers,LandUses]+Heterothrop_Resp[LandCovers,LandUses])
 Deep_C_sedimentation[LandCovers,LandUses] =
 C_GROUND_WATER[LandCovers,LandUses]*Deep_Sedimentation_Rate[LandCovers,LandUses]
 C_SURF_WATERS[LandCovers,LandUses](t) = C_SURF_WATERS[LandCovers,LandUses](t - dt) +
 (C_Net_Vertical_flux[LandCovers,LandUses] - C_Atmospheric_Exchanges[LandCovers,LandUses] -
 Shallow_C_Sedimentation[LandCovers,LandUses] - BioX_C[LandCovers,LandUses] -
 C_Spatial_exchange[LandCovers,LandUses]) * dt
 INIT C_SURF_WATERS[LandCovers,LandUses] = •IC_C_Surface_Water[LandCovers,LandUses]
 INFLOWS:
 C_Net_Vertical_flux[LandCovers,LandUses] =
 •C_Vert_Flux_Rate[LandCovers,LandUses]*C_GROUND_WATER[LandCovers,LandUses]
 OUTFLOWS:
 C_Atmospheric_Exchanges[LandCovers,LandUses] =
 C_Exchange_Coefficient[LandCovers,LandUses]*(C_Surface_Water_Concentration[LandCovers,LandUse
 s]-C_Atmospheric_Equilibrium)
 Shallow_C_Sedimentation[LandCovers,LandUses] =
 C_SURF_WATERS[LandCovers,LandUses]*Shallow_C_Sed_Rate[LandCovers,LandUses]
 BioX_C[AMF,NE] = 0*(GPP[AMF,NE]-
 (Autotroph_Resp[AMF,NE]+(Consumer_Resp[AMF,NE]+Heterothrop_Resp[AMF,NE])))
 BioX_C[AMF,CR] = 0*(GPP[AMF,CR]-
 (Autotroph_Resp[AMF,CR]+(Consumer_Resp[AMF,CR]+Heterothrop_Resp[AMF,CR])))
 BioX_C[AMF,PA] = 0*(GPP[AMF,PA]-
 (Autotroph_Resp[AMF,PA]+(Consumer_Resp[AMF,PA]+Heterothrop_Resp[AMF,PA])))
 BioX_C[AMF,FA] = 0*(GPP[AMF,FA]-
 (Autotroph_Resp[AMF,FA]+(Consumer_Resp[AMF,FA]+Heterothrop_Resp[AMF,FA])))
 BioX_C[AMF,UR] = 0*(GPP[AMF,UR]-
 (Autotroph_Resp[AMF,UR]+(Consumer_Resp[AMF,UR]+Heterothrop_Resp[AMF,UR])))
 BioX_C[SAV,NE] = 0*(GPP[SAV,NE]-
 (Autotroph_Resp[SAV,NE]+(Consumer_Resp[SAV,NE]+Heterothrop_Resp[SAV,NE])))
 BioX_C[SAV,CR] = 0*(GPP[SAV,CR]-
 (Autotroph_Resp[SAV,CR]+(Consumer_Resp[SAV,CR]+Heterothrop_Resp[SAV,CR])))
 BioX_C[SAV,PA] = 0*(GPP[SAV,PA]-
 (Autotroph_Resp[SAV,PA]+(Consumer_Resp[SAV,PA]+Heterothrop_Resp[SAV,PA])))
 BioX_C[SAV,FA] = 0*(GPP[SAV,FA]-
 (Autotroph_Resp[SAV,FA]+(Consumer_Resp[SAV,FA]+Heterothrop_Resp[SAV,FA])))
 BioX_C[SAV,UR] = 0*(GPP[SAV,UR]-
 (Autotroph_Resp[SAV,UR]+(Consumer_Resp[SAV,UR]+Heterothrop_Resp[SAV,UR])))
 BioX_C[RIV,NE] = (GPP[RIV,NE]-
 (Autotroph_Resp[RIV,NE]+(Consumer_Resp[RIV,NE]+Heterothrop_Resp[RIV,NE]))*7.5)
 BioX_C[RIV,CR] = 0*(GPP[RIV,CR]-
 (Autotroph_Resp[RIV,CR]+Consumer_Resp[RIV,CR]+Heterothrop_Resp[RIV,CR]))
 BioX_C[RIV,PA] = 0*(GPP[RIV,PA]-
 (Autotroph_Resp[RIV,PA]+(Consumer_Resp[RIV,PA]+Heterothrop_Resp[RIV,PA])))
 BioX_C[RIV,FA] = 0*(GPP[RIV,FA]-
 (Autotroph_Resp[RIV,FA]+(Consumer_Resp[RIV,FA]+Heterothrop_Resp[RIV,FA])))
 BioX_C[RIV,UR] = 0*(GPP[RIV,UR]-
 (Autotroph_Resp[RIV,UR]+(Consumer_Resp[RIV,UR]+Heterothrop_Resp[RIV,UR])))
 BioX_C[FLF,NE] = (GPP[FLF,NE]-
 (Autotroph_Resp[FLF,NE]+(Consumer_Resp[FLF,NE]+Heterothrop_Resp[FLF,NE]))*2.5)
 BioX_C[FLF,CR] = 0*(GPP[FLF,CR]-
 (Autotroph_Resp[FLF,CR]+(Consumer_Resp[FLF,CR]+Heterothrop_Resp[FLF,CR])))
 BioX_C[FLF,PA] = 0*(GPP[FLF,PA]-
 (Autotroph_Resp[FLF,PA]+(Consumer_Resp[FLF,PA]+Heterothrop_Resp[FLF,PA])))
 BioX_C[FLF,FA] = 0*(GPP[FLF,FA]-
 (Autotroph_Resp[FLF,FA]+(Consumer_Resp[FLF,FA]+Heterothrop_Resp[FLF,FA])))

```

BioX_C[FLF,UR] = 0*(GPP[FLF,UR]-
(Autotroph_Resp[FLF,UR]+Consumer_Resp[FLF,UR]+Heterothrop_Resp[FLF,UR]))
C_Spatial_exchange[LandCovers,LandUses] = IF SURFACE_WATER[LandCovers,LandUses]=0 THEN
0 ELSE
(Continental_Runoff[LandCovers,LandUses]/SURFACE_WATER[LandCovers,LandUses]*C_SURF_WA
TERS[LandCovers,LandUses])-(Andean_DIC[LandCovers,LandUses])
Andean_DIC[AMF,NE] = 0
Andean_DIC[AMF,CR] = 0
Andean_DIC[AMF,PA] = 0
Andean_DIC[AMF,FA] = 0
Andean_DIC[AMF,UR] = 0
Andean_DIC[SAV,NE] = 0
Andean_DIC[SAV,CR] = 0
Andean_DIC[SAV,PA] = 0
Andean_DIC[SAV,FA] = 0
Andean_DIC[SAV,UR] = 0
Andean_DIC[RIV,NE] = 20E6
Andean_DIC[RIV,CR] = 0
Andean_DIC[RIV,PA] = 0
Andean_DIC[RIV,FA] = 0
Andean_DIC[RIV,UR] = 0
Andean_DIC[FLF,NE] = 0
Andean_DIC[FLF,CR] = 0
Andean_DIC[FLF,PA] = 0
Andean_DIC[FLF,FA] = 0
Andean_DIC[FLF,UR] = 0
C_Atmospheric_Equilibrium = 10
C_Exchange_Coefficient[AMF,NE] = 0
C_Exchange_Coefficient[AMF,CR] = 0
C_Exchange_Coefficient[AMF,PA] = 0
C_Exchange_Coefficient[AMF,FA] = 0
C_Exchange_Coefficient[AMF,UR] = 0
C_Exchange_Coefficient[SAV,NE] = 0
C_Exchange_Coefficient[SAV,CR] = 0
C_Exchange_Coefficient[SAV,PA] = 0
C_Exchange_Coefficient[SAV,FA] = 0
C_Exchange_Coefficient[SAV,UR] = 0
C_Exchange_Coefficient[RIV,NE] = 2.3*365*2
C_Exchange_Coefficient[RIV,CR] = 0
C_Exchange_Coefficient[RIV,PA] = 0
C_Exchange_Coefficient[RIV,FA] = 0
C_Exchange_Coefficient[RIV,UR] = 0
C_Exchange_Coefficient[FLF,NE] = 0.65*365
C_Exchange_Coefficient[FLF,CR] = 0
C_Exchange_Coefficient[FLF,PA] = 0
C_Exchange_Coefficient[FLF,FA] = 0
C_Exchange_Coefficient[FLF,UR] = 0
C_Surface_Water_Concentration[AMF,NE] = IF AmazonLand[AMF,NE] = 0 THEN 0 ELSE
0*C_SURF_WATERS[AMF,NE]/AmazonLand[AMF,NE]
C_Surface_Water_Concentration[AMF,CR] = IF AmazonLand[AMF,CR] = 0 THEN 0 ELSE
0*C_SURF_WATERS[AMF,CR]/AmazonLand[AMF,CR]
C_Surface_Water_Concentration[AMF,PA] = IF AmazonLand[AMF,PA] = 0 THEN 0 ELSE
0*C_SURF_WATERS[AMF,PA]/AmazonLand[AMF,PA]
C_Surface_Water_Concentration[AMF,FA] = IF AmazonLand[AMF,FA] = 0 THEN 0 ELSE
0*C_SURF_WATERS[AMF,FA]/AmazonLand[AMF,FA]

```

C_Surface_Water_Concentration[AMF,UR] = IF AmazonLand[AMF,UR] = 0 THEN 0 ELSE
 0*C_SURF_WATERS[AMF,UR]/AmazonLand[AMF,UR]
 C_Surface_Water_Concentration[SAV,NE] = IF AmazonLand[SAV,NE] = 0 THEN 0 ELSE
 0*C_SURF_WATERS[SAV,NE]/AmazonLand[SAV,NE]
 C_Surface_Water_Concentration[SAV,CR] = IF AmazonLand[SAV,CR] = 0 THEN 0 ELSE
 0*C_SURF_WATERS[SAV,CR]/AmazonLand[SAV,CR]
 C_Surface_Water_Concentration[SAV,PA] = IF AmazonLand[SAV,PA] = 0 THEN 0 ELSE
 0*C_SURF_WATERS[SAV,PA]/AmazonLand[SAV,PA]
 C_Surface_Water_Concentration[SAV,FA] = IF AmazonLand[SAV,FA] = 0 THEN 0 ELSE
 0*C_SURF_WATERS[SAV,FA]/AmazonLand[SAV,FA]
 C_Surface_Water_Concentration[SAV,UR] = IF AmazonLand[SAV,UR] = 0 THEN 0 ELSE
 0*C_SURF_WATERS[SAV,UR]/AmazonLand[SAV,UR]
 C_Surface_Water_Concentration[RIV,NE] = IF AmazonLand[RIV,NE] = 0 THEN 0 ELSE
 C_SURF_WATERS[RIV,NE]/AmazonLand[RIV,NE]
 C_Surface_Water_Concentration[RIV,CR] = IF AmazonLand[RIV,CR] = 0 THEN 0 ELSE
 0*C_SURF_WATERS[RIV,CR]/AmazonLand[RIV,CR]
 C_Surface_Water_Concentration[RIV,PA] = IF AmazonLand[RIV,PA] = 0 THEN 0 ELSE
 0*C_SURF_WATERS[RIV,PA]/AmazonLand[RIV,PA]
 C_Surface_Water_Concentration[RIV,FA] = IF AmazonLand[RIV,FA] = 0 THEN 0 ELSE
 0*C_SURF_WATERS[RIV,FA]/AmazonLand[RIV,FA]
 C_Surface_Water_Concentration[RIV,UR] = IF AmazonLand[RIV,UR] = 0 THEN 0 ELSE
 0*C_SURF_WATERS[RIV,UR]/AmazonLand[RIV,UR]
 C_Surface_Water_Concentration[FLF,NE] = IF AmazonLand[FLF,NE] = 0 THEN 0 ELSE
 C_SURF_WATERS[FLF,NE]/AmazonLand[FLF,NE]
 C_Surface_Water_Concentration[FLF,CR] = IF AmazonLand[FLF,CR] = 0 THEN 0 ELSE
 0*C_SURF_WATERS[FLF,CR]/AmazonLand[FLF,CR]
 C_Surface_Water_Concentration[FLF,PA] = IF AmazonLand[FLF,PA] = 0 THEN 0 ELSE
 0*C_SURF_WATERS[FLF,PA]/AmazonLand[FLF,PA]
 C_Surface_Water_Concentration[FLF,FA] = IF AmazonLand[FLF,FA] = 0 THEN 0 ELSE
 0*C_SURF_WATERS[FLF,FA]/AmazonLand[FLF,FA]
 C_Surface_Water_Concentration[FLF,UR] = IF AmazonLand[FLF,UR] = 0 THEN 0 ELSE
 0*C_SURF_WATERS[FLF,UR]/AmazonLand[FLF,UR]
 Total_C_Atm_Exchange =
 C_Atmospheric_Exchanges[AMF,NE]+C_Atmospheric_Exchanges[AMF,CR]+C_Atmospheric_Exchange
 es[AMF,PA]+C_Atmospheric_Exchanges[AMF,FA]+C_Atmospheric_Exchanges[AMF,UR]+C_Atmosp
 heric_Exchanges[SAV,NE]+C_Atmospheric_Exchanges[SAV,CR]+C_Atmospheric_Exchanges[SAV,P
 A]+C_Atmospheric_Exchanges[SAV,FA]+C_Atmospheric_Exchanges[SAV,UR]+C_Atmospheric_Excha
 nges[RIV,NE]+C_Atmospheric_Exchanges[FLF,NE]
 Total_Discharge_DIC =
 C_Spatial_exchange[AMF,NE]+C_Spatial_exchange[AMF,CR]+C_Spatial_exchange[AMF,PA]+C_Spati
 al_exchange[AMF,FA]+C_Spatial_exchange[AMF,UR]+C_Spatial_exchange[SAV,NE]+C_Spatial_excha
 nge[SAV,CR]+C_Spatial_exchange[SAV,PA]+C_Spatial_exchange[SAV,FA]+C_Spatial_exchange[SAV,
 UR]+C_Spatial_exchange[RIV,NE]+C_Spatial_exchange[FLF,NE]
 •C_Vert_Flux_Rate[AMF,NE] = 0
 •C_Vert_Flux_Rate[AMF,CR] = 0
 •C_Vert_Flux_Rate[AMF,PA] = 0
 •C_Vert_Flux_Rate[AMF,FA] = 0
 •C_Vert_Flux_Rate[AMF,UR] = 0
 •C_Vert_Flux_Rate[SAV,NE] = 0
 •C_Vert_Flux_Rate[SAV,CR] = 0
 •C_Vert_Flux_Rate[SAV,PA] = 0
 •C_Vert_Flux_Rate[SAV,FA] = 0
 •C_Vert_Flux_Rate[SAV,UR] = 0
 •C_Vert_Flux_Rate[RIV,NE] = 0.0001
 •C_Vert_Flux_Rate[RIV,CR] = 0
 •C_Vert_Flux_Rate[RIV,PA] = 0

- C_Vert_Flux_Rate[RIV,FA] = 0
- C_Vert_Flux_Rate[RIV,UR] = 0
- C_Vert_Flux_Rate[FLF,NE] = 0.0001
- C_Vert_Flux_Rate[FLF,CR] = 0
- C_Vert_Flux_Rate[FLF,PA] = 0
- C_Vert_Flux_Rate[FLF,FA] = 0
- C_Vert_Flux_Rate[FLF,UR] = 0
- Deep_Sedimentation_Rate[AMF,NE] = 0
- Deep_Sedimentation_Rate[AMF,CR] = 0
- Deep_Sedimentation_Rate[AMF,PA] = 0
- Deep_Sedimentation_Rate[AMF,FA] = 0
- Deep_Sedimentation_Rate[AMF,UR] = 0
- Deep_Sedimentation_Rate[SAV,NE] = 0
- Deep_Sedimentation_Rate[SAV,CR] = 0
- Deep_Sedimentation_Rate[SAV,PA] = 0
- Deep_Sedimentation_Rate[SAV,FA] = 0
- Deep_Sedimentation_Rate[SAV,UR] = 0
- Deep_Sedimentation_Rate[RIV,NE] = 0
- Deep_Sedimentation_Rate[RIV,CR] = 0
- Deep_Sedimentation_Rate[RIV,PA] = 0
- Deep_Sedimentation_Rate[RIV,FA] = 0
- Deep_Sedimentation_Rate[RIV,UR] = 0
- Deep_Sedimentation_Rate[FLF,NE] = 0
- Deep_Sedimentation_Rate[FLF,CR] = 0
- Deep_Sedimentation_Rate[FLF,PA] = 0
- Deep_Sedimentation_Rate[FLF,FA] = 0
- Deep_Sedimentation_Rate[FLF,UR] = 0
- IC_C_Deep_Water[LandCovers,LandUses] = 25E6
- IC_C_Surface_Water[LandCovers,LandUses] = 100E6
- Shallow_C_Sed_Rate[AMF,NE] = 0
- Shallow_C_Sed_Rate[AMF,CR] = 0
- Shallow_C_Sed_Rate[AMF,PA] = 0
- Shallow_C_Sed_Rate[AMF,FA] = 0
- Shallow_C_Sed_Rate[AMF,UR] = 0
- Shallow_C_Sed_Rate[SAV,NE] = 0
- Shallow_C_Sed_Rate[SAV,CR] = 0
- Shallow_C_Sed_Rate[SAV,PA] = 0
- Shallow_C_Sed_Rate[SAV,FA] = 0
- Shallow_C_Sed_Rate[SAV,UR] = 0
- Shallow_C_Sed_Rate[RIV,NE] = 0.1
- Shallow_C_Sed_Rate[RIV,CR] = 0
- Shallow_C_Sed_Rate[RIV,PA] = 0
- Shallow_C_Sed_Rate[RIV,FA] = 0
- Shallow_C_Sed_Rate[RIV,UR] = 0
- Shallow_C_Sed_Rate[FLF,NE] = 0.1
- Shallow_C_Sed_Rate[FLF,CR] = 0
- Shallow_C_Sed_Rate[FLF,PA] = 0
- Shallow_C_Sed_Rate[FLF,FA] = 0
- Shallow_C_Sed_Rate[FLF,UR] = 0

SilicatesWithinSectorLithosphere

Particulate_and_Dissolved_Sediments(t) = Particulate_and_Dissolved_Sediments(t - dt) +
(Incoming_Sed_from_Amazon_River_Andean_sources_VG + In_System_Sed_from_Trib_and_Floodplain
- Sediments_Discharge_to_Ocean - Sedimentation_into_Soil_Formation) * dt
INIT Particulate_and_Dissolved_Sediments = •IC_TSS

INFLOWS:

Incoming_Sed_from_Amazon_River_Andean_sources_VG =
•Sediments_Incoming_Rate*Particulate_and_Dissolved_Sediments
In_System_Sed_from_Trib_and_Floodplain = Total_Erosion

OUTFLOWS:

Sediments_Discharge_to_Ocean = Particulate_and_Dissolved_Sediments*•Discharge_Rate
Sedimentation_into_Soil_Formation = Particulate_and_Dissolved_Sediments*•Sedimentation_Rate
SILICATE_SOIL(t) = SILICATE_SOIL(t - dt) + (Sedimentation_into_Soil_Formation -
In_System_Sed_from_Trib_and_Floodplain) * dt
INIT SILICATE_SOIL = •IC_Min_Soil

INFLOWS:

Sedimentation_into_Soil_Formation = Particulate_and_Dissolved_Sediments*•Sedimentation_Rate

OUTFLOWS:

In_System_Sed_from_Trib_and_Floodplain = Total_Erosion
Amazon_River_Discharge_at_OB = 159*365*24*60*60
CE_km2 =
SUM(Che_mical_Erosion[AMF,NE]+Che_mical_Erosion[AMF,CR]+Che_mical_Erosion[AMF,PA]+Che_mical_Erosion[AMF,FA]+Che_mical_Erosion[AMF,UR])/Brazilian_Legal_Amazon
Chemical_Erosion[LandCovers,LandUses] =
•Chemical_Erosion_Rate*Me_mical_Erosion[LandCovers,LandUses]
Me_mical_Erosion[LandCovers,LandUses] =
AmazonLand[LandCovers,LandUses]*•Rate_of_Soil_Loss*•Me_mical_Erosion_Rate[LandCovers,LandUses]
ME_km2 =
SUM(Me_mical_Erosion[AMF,NE]+Me_mical_Erosion[AMF,CR]+Me_mical_Erosion[AMF,PA]+Me_mical_Erosion[AMF,FA]+Me_mical_Erosion[AMF,UR])/Brazilian_Legal_Amazon
Total_Erosion =
SUM(Me_mical_Erosion[AMF,NE]+Me_mical_Erosion[AMF,CR]+Me_mical_Erosion[AMF,PA]+Me_mical_Erosion[AMF,FA]+Me_mical_Erosion[AMF,UR])+SUM(Che_mical_Erosion[AMF,NE]+Che_mical_Erosion[AMF,CR]+Che_mical_Erosion[AMF,PA]+Che_mical_Erosion[AMF,FA]+Che_mical_Erosion[AMF,UR])
TSSOB = 1156E6
•Chemical_Erosion_Rate = 0.681
•Discharge_Rate = 1
•IC_Min_Soil = 1e12
•IC_TSS = 1E9
•Me_mical_Erosion_Rate[AMF,NE] = 1
•Me_mical_Erosion_Rate[AMF,CR] = 1
•Me_mical_Erosion_Rate[AMF,PA] = 1
•Me_mical_Erosion_Rate[AMF,FA] = 1
•Me_mical_Erosion_Rate[AMF,UR] = 1
•Me_mical_Erosion_Rate[SAV,NE] = 1
•Me_mical_Erosion_Rate[SAV,CR] = 1
•Me_mical_Erosion_Rate[SAV,PA] = 1
•Me_mical_Erosion_Rate[SAV,FA] = 1
•Me_mical_Erosion_Rate[SAV,UR] = 1
•Me_mical_Erosion_Rate[RIV,NE] = 1
•Me_mical_Erosion_Rate[RIV,CR] = 1
•Me_mical_Erosion_Rate[RIV,PA] = 1
•Me_mical_Erosion_Rate[RIV,FA] = 1
•Me_mical_Erosion_Rate[RIV,UR] = 1
•Me_mical_Erosion_Rate[FLF,NE] = 1
•Me_mical_Erosion_Rate[FLF,CR] = 1
•Me_mical_Erosion_Rate[FLF,PA] = 1
•Me_mical_Erosion_Rate[FLF,FA] = 1

- Mechanical_Erosion_Rate[FLF,UR] = 1
- Rate_of_Soil_Loss = 150
- Sedimentation_Rate = 0.25
- Sediments_Incoming_Rate = 0.25

SocialWithinSectorAnthrosphere

Rules__Norms(t) = Rules__Norms(t - dt) + (Conformation_building - RN_loss) * dt
 INIT Rules__Norms = •IC_Rules_and_Norms

INFLOWS:

Conformation_building = •SC_effect_on_Rules_and_Norms*SOCIAL_NETWORK

OUTFLOWS:

RN_loss = Rules__Norms*•Conformation_Loss_Rate

SOCIAL_NETWORK(t) = SOCIAL_NETWORK(t - dt) + (SC_Network_building - SC_Disintegration) * dt

INIT SOCIAL_NETWORK = •IC_Network

INFLOWS:

SC_Network_building = (1 - (SOCIAL_NETWORK/•Max_Network))*(GS_Social_Capital_Formation)/(Rules__Norms*•SC_investment_SC_Conv)

OUTFLOWS:

SC_Disintegration = •SC_Disintegration_Rate*SOCIAL_NETWORK

Price_on_Social_Capital = IF SOCIAL_NETWORK=0 THEN 0 ELSE

(•SC_Exp*GS_Econ_Prod)/SOCIAL_NETWORK

SOCIAL_NETWORK_PerCap = IF Amazon_Population=0 THEN 0 ELSE

SOCIAL_NETWORK/Amazon_Population

•Conformation_Loss_Rate = 0.1

•IC_Network = 1.24

•IC_Rules_and_Norms = 2

•Max_Network = 40

•SC_Disintegration_Rate = 0.01

•SC_effect_on_Rules_and_Norms = 0.1

•SC_investment_SC_Conv = 40

WaterWithinSectorHydrosphere

GROUND_WATER[LandCovers,LandUses](t) = GROUND_WATER[LandCovers,LandUses](t - dt) + (Unsat_Downwelling[LandCovers,LandUses] - Ground_Water_Use[LandCovers,LandUses] - Upwelling[LandCovers,LandUses]) * dt

INIT GROUND_WATER[LandCovers,LandUses] = IC_Ground_Water[LandCovers,LandUses]

INFLOWS:

Unsat_Downwelling[LandCovers,LandUses] = IF Unsaturated_Capilarity[LandCovers,LandUses]=0 THEN 0 ELSE

(MIN(0,•Welling_Rate[LandCovers,LandUses]*GROUND_WATER[LandCovers,LandUses]+MAX(0,UNSATURATED_WATER[LandCovers,LandUses]/Unsaturated_Capilarity[LandCovers,LandUses])))

OUTFLOWS:

Ground_Water_Use[LandCovers,LandUses] =

MIN((•Pers_Recoverable_GrW[LandCovers,LandUses]*GROUND_WATER[LandCovers,LandUses]),(Demand_Water-Surface_Water_Use[LandCovers,LandUses]))

Upwelling[LandCovers,LandUses] =

•Upwelling_Rate[LandCovers,LandUses]*GROUND_WATER[LandCovers,LandUses]

SURFACE_WATER[LandCovers,LandUses](t) = SURFACE_WATER[LandCovers,LandUses](t - dt) +

(Cleaned_up_water[LandCovers,LandUses] + Upwelling[LandCovers,LandUses] +

Andean_Waters[LandCovers,LandUses] + Precipitation_into_Surface[LandCovers,LandUses] -

Surface_to_Unsaturated[LandCovers,LandUses] - Surface_Water_Use[LandCovers,LandUses] -

Continental_Runoff[LandCovers,LandUses]) * dt

INIT SURFACE_WATER[LandCovers,LandUses] = IC_Surface_Water[LandCovers,LandUses]
 INFLOWS:
 Cleaned_up_water[LandCovers,LandUses] =
 WASTE_WATER[LandCovers,LandUses]*•Waste_Water_Assimilation[LandCovers,LandUses]
 Upwelling[LandCovers,LandUses] =
 •Upwelling_Rate[LandCovers,LandUses]*GROUND_WATER[LandCovers,LandUses]
 Andean_Waters[LandCovers,LandUses] = Upstream__Waters[LandCovers,LandUses]
 Precipitation_into_Surface[LandCovers,LandUses] = Precipitation[LandCovers,LandUses]-
 Evaporation[LandCovers,LandUses]
 OUTFLOWS:
 Surface_to_Unsaturated[LandCovers,LandUses] = Saturation_Deficit[LandCovers,LandUses]
 Surface_Water_Use[LandCovers,LandUses] =
 (MIN((SURFACE_WATER[LandCovers,LandUses]*•Perc_usable_water[LandCovers,LandUses]),Deman
 d_Water*1e3))
 Continental_Runoff[LandCovers,LandUses] = Surface_Runoff[LandCovers,LandUses]
 UNSATURATED_WATER[LandCovers,LandUses](t) =
 UNSATURATED_WATER[LandCovers,LandUses](t - dt) +
 (Surface_to_Unsaturated[LandCovers,LandUses] - Unsat_Downwelling[LandCovers,LandUses] -
 Transpiration[LandCovers,LandUses]) * dt
 INIT UNSATURATED_WATER[LandCovers,LandUses] =
 IC_Unsaturated_Water[LandCovers,LandUses]
 INFLOWS:
 Surface_to_Unsaturated[LandCovers,LandUses] = Saturation_Deficit[LandCovers,LandUses]
 OUTFLOWS:
 Unsat_Downwelling[LandCovers,LandUses] = IF Unsaturated_Capilarity[LandCovers,LandUses]=0
 THEN 0 ELSE
 (MIN(0,•Welling_Rate[LandCovers,LandUses]*GROUND_WATER[LandCovers,LandUses]+MAX(0,UN
 SATURATED_WATER[LandCovers,LandUses]/Unsaturated_Capilarity[LandCovers,LandUses]))
 Transpiration[LandCovers,LandUses] =
 Water_Available_to_Plants[LandCovers,LandUses]*•Transpiration_Rate[LandCovers,LandUses]
 WASTE_WATER[LandCovers,LandUses](t) = WASTE_WATER[LandCovers,LandUses](t - dt) +
 (Ground_Water_Use[LandCovers,LandUses] + Surface_Water_Use[LandCovers,LandUses] -
 Cleaned_up_water[LandCovers,LandUses]) * dt
 INIT WASTE_WATER[LandCovers,LandUses] = IC_Waste_Water[LandCovers,LandUses]
 INFLOWS:
 Ground_Water_Use[LandCovers,LandUses] =
 MIN((•Pers_Recoverable_GrW[LandCovers,LandUses]*GROUND_WATER[LandCovers,LandUses]),(De
 mand_Water-Surface_Water_Use[LandCovers,LandUses]))
 Surface_Water_Use[LandCovers,LandUses] =
 (MIN((SURFACE_WATER[LandCovers,LandUses]*•Perc_usable_water[LandCovers,LandUses]),Deman
 d_Water*1e3))
 OUTFLOWS:
 Cleaned_up_water[LandCovers,LandUses] =
 WASTE_WATER[LandCovers,LandUses]*•Waste_Water_Assimilation[LandCovers,LandUses]
 Atlantic_moisture = 10
 Erosion_Effect_on_Soil_Capilarity[AMF,NE] =
 •Mechanical_Erosion_Rate[AMF,NE]/(•Mechanical_Erosion_Rate[AMF,NE])
 Erosion_Effect_on_Soil_Capilarity[AMF,CR] =
 •Mechanical_Erosion_Rate[AMF,CR]/(•Mechanical_Erosion_Rate[AMF,NE]*100)+1.0
 Erosion_Effect_on_Soil_Capilarity[AMF,PA] =
 •Mechanical_Erosion_Rate[AMF,PA]/(•Mechanical_Erosion_Rate[AMF,NE]*100)+1.0
 Erosion_Effect_on_Soil_Capilarity[AMF,FA] =
 •Mechanical_Erosion_Rate[AMF,FA]/(•Mechanical_Erosion_Rate[AMF,NE]*100)+1.0
 Erosion_Effect_on_Soil_Capilarity[AMF,UR] =
 •Mechanical_Erosion_Rate[AMF,UR]/(•Mechanical_Erosion_Rate[AMF,NE]*100)+1.0

Erosion_Effect_on_Soil_Capilarity[SAV,NE] =
 •Mechanical_Erosion_Rate[SAV,NE]/(•Mechanical_Erosion_Rate[AMF,NE]*100)+1.0
 Erosion_Effect_on_Soil_Capilarity[SAV,CR] =
 •Mechanical_Erosion_Rate[SAV,CR]/(•Mechanical_Erosion_Rate[AMF,NE]*100)+1.0
 Erosion_Effect_on_Soil_Capilarity[SAV,PA] =
 •Mechanical_Erosion_Rate[SAV,PA]/(•Mechanical_Erosion_Rate[AMF,NE]*100)+1.0
 Erosion_Effect_on_Soil_Capilarity[SAV,FA] =
 •Mechanical_Erosion_Rate[SAV,FA]/(•Mechanical_Erosion_Rate[AMF,NE]*100)+1.0
 Erosion_Effect_on_Soil_Capilarity[SAV,UR] =
 •Mechanical_Erosion_Rate[SAV,UR]/(•Mechanical_Erosion_Rate[AMF,NE]*100)+1.0
 Erosion_Effect_on_Soil_Capilarity[RIV,NE] =
 •Mechanical_Erosion_Rate[RIV,NE]/(•Mechanical_Erosion_Rate[AMF,NE]*100)+1.0
 Erosion_Effect_on_Soil_Capilarity[RIV,CR] =
 •Mechanical_Erosion_Rate[RIV,CR]/(•Mechanical_Erosion_Rate[AMF,NE]*100)+1.0
 Erosion_Effect_on_Soil_Capilarity[RIV,PA] =
 •Mechanical_Erosion_Rate[RIV,PA]/(•Mechanical_Erosion_Rate[AMF,NE]*100)+1.0
 Erosion_Effect_on_Soil_Capilarity[RIV,FA] =
 •Mechanical_Erosion_Rate[RIV,FA]/(•Mechanical_Erosion_Rate[AMF,NE]*100)+1.0
 Erosion_Effect_on_Soil_Capilarity[RIV,UR] =
 •Mechanical_Erosion_Rate[RIV,UR]/(•Mechanical_Erosion_Rate[AMF,NE]*100)+1.0
 Erosion_Effect_on_Soil_Capilarity[FLF,NE] =
 •Mechanical_Erosion_Rate[FLF,NE]/(•Mechanical_Erosion_Rate[AMF,NE]*100)+1.0
 Erosion_Effect_on_Soil_Capilarity[FLF,CR] =
 •Mechanical_Erosion_Rate[FLF,CR]/(•Mechanical_Erosion_Rate[AMF,NE]*100)+1.0
 Erosion_Effect_on_Soil_Capilarity[FLF,PA] =
 •Mechanical_Erosion_Rate[FLF,PA]/(•Mechanical_Erosion_Rate[AMF,NE]*100)+1.0
 Erosion_Effect_on_Soil_Capilarity[FLF,FA] =
 •Mechanical_Erosion_Rate[FLF,FA]/(•Mechanical_Erosion_Rate[AMF,NE]*100)+1.0
 Erosion_Effect_on_Soil_Capilarity[FLF,UR] =
 •Mechanical_Erosion_Rate[FLF,UR]/(•Mechanical_Erosion_Rate[AMF,NE]*100)+1.0
 Evaporation[LandCovers,LandUses] =
 •Evaporation_Rate[LandCovers,LandUses]*SURFACE_WATER[LandCovers,LandUses]
 EvapoTranspiration[LandCovers,LandUses] =
 Transpiration[LandCovers,LandUses]+Evaporation[LandCovers,LandUses]
 EvapoTrans_km2 = IF Total_Amazon_Land=0 THEN 0 ELSE
 Total_EvapoTranspiration/(Total_Amazon_Land*1e6)
 IC_Ground_Water[LandCovers,LandUses] =
 IC_LCLU[LandCovers,LandUses]*1E6*•IC_Ground_Water_Rate[LandCovers,LandUses]
 IC_Surface_Water[AMF,NE] = IC_LCLU[AMF,NE]*•IC_Surf_Water_Rate[AMF,NE]
 IC_Surface_Water[AMF,CR] = IC_LCLU[AMF,CR]*•IC_Surf_Water_Rate[AMF,CR]
 IC_Surface_Water[AMF,PA] = IC_LCLU[AMF,PA]*•IC_Surf_Water_Rate[AMF,PA]
 IC_Surface_Water[AMF,FA] = IC_LCLU[AMF,FA]*•IC_Surf_Water_Rate[AMF,FA]
 IC_Surface_Water[AMF,UR] = IC_LCLU[AMF,UR]*•IC_Surf_Water_Rate[AMF,UR]
 IC_Surface_Water[SAV,NE] = IC_LCLU[SAV,NE]*•IC_Surf_Water_Rate[SAV,NE]
 IC_Surface_Water[SAV,CR] = IC_LCLU[SAV,CR]*•IC_Surf_Water_Rate[SAV,CR]
 IC_Surface_Water[SAV,PA] = IC_LCLU[SAV,PA]*•IC_Surf_Water_Rate[SAV,PA]
 IC_Surface_Water[SAV,FA] = IC_LCLU[SAV,FA]*•IC_Surf_Water_Rate[SAV,FA]
 IC_Surface_Water[SAV,UR] = IC_LCLU[SAV,UR]*•IC_Surf_Water_Rate[SAV,UR]
 IC_Surface_Water[RIV,NE] = IC_LCLU[RIV,NE]*1E6*•IC_Surf_Water_Rate[RIV,NE]
 IC_Surface_Water[RIV,CR] = IC_LCLU[RIV,CR]*•IC_Surf_Water_Rate[RIV,CR]
 IC_Surface_Water[RIV,PA] = IC_LCLU[RIV,PA]*•IC_Surf_Water_Rate[RIV,PA]
 IC_Surface_Water[RIV,FA] = IC_LCLU[RIV,FA]*•IC_Surf_Water_Rate[RIV,FA]
 IC_Surface_Water[RIV,UR] = IC_LCLU[RIV,UR]*•IC_Surf_Water_Rate[RIV,UR]
 IC_Surface_Water[FLF,NE] = IC_LCLU[FLF,NE]*1E6*•IC_Surf_Water_Rate[FLF,NE]
 IC_Surface_Water[FLF,CR] = IC_LCLU[FLF,CR]*•IC_Surf_Water_Rate[FLF,CR]
 IC_Surface_Water[FLF,PA] = IC_LCLU[FLF,PA]*•IC_Surf_Water_Rate[FLF,PA]

IC_Surface_Water[FLF,FA] = IC_LCLU[FLF,FA]*IC_Surf_Water_Rate[FLF,FA]
 IC_Surface_Water[FLF,UR] = IC_LCLU[FLF,UR]*IC_Surf_Water_Rate[FLF,UR]
 IC_Unsaturated_Water[LandCovers,LandUses] =
 IC_LCLU[LandCovers,LandUses]*1E6*IC_Unsat_Water__Rate[LandCovers,LandUses]
 IC_Waste_Water[LandCovers,LandUses] =
 IC_LCLU[LandCovers,LandUses]*1E6*IC_Waste_Water_Rate[LandCovers,LandUses]
 Prec_km2 = IF Total_Amazon_Land=0 THEN 0 ELSE
 (Total_Precipitation_into_Surface/1E6)/Total_Amazon_Land
 Root_Depth[LandCovers,LandUses] = 1
 Runoff_km2 = IF Total_Amazon_Land=0 THEN 0 ELSE
 Total_Surface_Runoff/(Total_Amazon_Land*1e6)
 Saturation_Deficit[LandCovers,LandUses] = Unsaturated_Capilarity[LandCovers,LandUses]-
 UNSATURATED_WATER[LandCovers,LandUses]
 Surface_Runoff[LandCovers,LandUses] =
 •Runoff_Rate[LandCovers,LandUses]*Precipitation_into_Surface[LandCovers,LandUses]*Slope[LandCo
 vers,LandUses]
 TOTAL_AMAZON_WATER = TOTAL_SW+TOTAL_UW+TOTAL_GW
 Total_Continental_Runoff =
 (Continental_Runoff[AMF,NE]+Continental_Runoff[AMF,CR]+Continental_Runoff[AMF,PA]+Continent
 al_Runoff[AMF,FA]+Continental_Runoff[AMF,UR]+Continental_Runoff[SAV,NE]+Continental_Runoff[
 SAV,CR]+Continental_Runoff[SAV,PA]+Continental_Runoff[SAV,FA]+Continental_Runoff[SAV,UR]+
 Continental_Runoff[RIV,NE]+Continental_Runoff[FLF,NE])
 Total_Evaporation =
 (Evaporation[AMF,NE]+Evaporation[AMF,CR]+Evaporation[AMF,PA]+Evaporation[AMF,FA]+Evapora
 tion[AMF,UR]+Evaporation[SAV,NE]+Evaporation[SAV,CR]+Evaporation[SAV,PA]+Evaporation[SAV,
 FA]+Evaporation[SAV,UR]+Evaporation[RIV,NE]+Evaporation[FLF,NE])
 Total_EvapoTranspiration =
 (Evapotranspiration[AMF,NE]+Evapotranspiration[AMF,AG]+Evapotranspiration[AMF,P]+Evapotranspir
 ation[AMF,FA]+Evapotranspiration[AMF,U]+Evapotranspiration[SAV,NE]+Evapotranspiration[SAV,AG
]+Evapotranspiration[SAV,P]+Evapotranspiration[SAV,FA]+Evapotranspiration[SAV,U]+Evapotranspirat
 ion[LakesRivers,NE]+Evapotranspiration[Wetlands,NE])
 TOTAL_GW =
 (GROUND_WATER[AMF,NE]+GROUND_WATER[AMF,CR]+GROUND_WATER[AMF,PA]+GROU
 ND_WATER[AMF,FA]+GROUND_WATER[AMF,UR]+GROUND_WATER[SAV,NE]+GROUND_W
 ATER[SAV,CR]+GROUND_WATER[SAV,PA]+GROUND_WATER[SAV,FA]+GROUND_WATER[S
 AV,UR])
 Total_Precipitation_into_Surface = ARRAYSUM(Precipitation_into_Surface[*,*])
 Total_Soil_Saturation_Deficit =
 (Saturation_Deficit[AMF,NE]+Saturation_Deficit[AMF,CR]+Saturation_Deficit[AMF,PA]+Saturation_De
 ficit[AMF,FA]+Saturation_Deficit[AMF,UR]+Saturation_Deficit[SAV,NE]+Saturation_Deficit[SAV,CR]
 +Saturation_Deficit[SAV,PA]+Saturation_Deficit[SAV,FA]+Saturation_Deficit[SAV,UR])
 Total_Surface_Runoff =
 (Surface_Runoff[AMF,NE]+Surface_Runoff[AMF,CR]+Surface_Runoff[AMF,PA]+Surface_Runoff[AM
 F,FA]+Surface_Runoff[AMF,UR]+Surface_Runoff[SAV,NE]+Surface_Runoff[SAV,CR]+Surface_Runoff
 [SAV,PA]+Surface_Runoff[SAV,FA]+Surface_Runoff[SAV,UR])
 Total_Surface_to_Unsaturated =
 (Surface_to_Unsaturated[AMF,NE]+Surface_to_Unsaturated[AMF,CR]+Surface_to_Unsaturated[AMF,P
 A]+Surface_to_Unsaturated[AMF,FA]+Surface_to_Unsaturated[AMF,UR]+Surface_to_Unsaturated[SAV,
 NE]+Surface_to_Unsaturated[AMF,CR]+Surface_to_Unsaturated[SAV,PA]+Surface_to_Unsaturated[SA
 V,FA]+Surface_to_Unsaturated[SAV,UR])
 TOTAL_SW =
 SURFACE_WATER[AMF,NE]+SURFACE_WATER[AMF,CR]+SURFACE_WATER[AMF,PA]+SURF
 ACE_WATER[AMF,FA]+SURFACE_WATER[AMF,UR]
 +SURFACE_WATER[SAV,NE]+SURFACE_WATER[SAV,CR]+SURFACE_WATER[SAV,PA]+SUR
 FACE_WATER[SAV,FA]+SURFACE_WATER[SAV,UR]
 +SURFACE_WATER[RIV,NE]+SURFACE_WATER[FLF,NE]

TOTAL_UD =
Unsat_Downwelling[AMF,NE]+Unsat_Downwelling[AMF,CR]+Unsat_Downwelling[AMF,PA]+Unsat_Downwelling[AMF,FA]+Unsat_Downwelling[AMF,UR]+Unsat_Downwelling[SAV,NE]+Unsat_Downwelling[SAV,CR]+Unsat_Downwelling[SAV,PA]+Unsat_Downwelling[SAV,FA]+Unsat_Downwelling[SAV,UR]
Total_Unsaturated_Capilarity =
(Unsaturated_Capilarity[AMF,NE]+Unsaturated_Capilarity[AMF,CR]+Unsaturated_Capilarity[AMF,PA]+Unsaturated_Capilarity[AMF,FA]+Unsaturated_Capilarity[AMF,UR]+Unsaturated_Capilarity[SAV,NE]+Unsaturated_Capilarity[AMF,CR]+Unsaturated_Capilarity[SAV,PA]+Unsaturated_Capilarity[SAV,FA]+Unsaturated_Capilarity[SAV,UR])
TOTAL_UW =
(UNSATURATED_WATER[AMF,NE]+UNSATURATED_WATER[AMF,CR]+UNSATURATED_WATER[AMF,PA]+UNSATURATED_WATER[AMF,FA]+UNSATURATED_WATER[AMF,UR]+UNSATURATED_WATER[SAV,NE]+UNSATURATED_WATER[SAV,CR]+UNSATURATED_WATER[SAV,PA]+UNSATURATED_WATER[SAV,FA]+UNSATURATED_WATER[SAV,UR])
Total_Water_Available_to_Vegetation =
(Water_Available_to_Plants[AMF,NE]+Water_Available_to_Plants[AMF,CR]+Water_Available_to_Plants[AMF,PA]+Water_Available_to_Plants[AMF,FA]+Water_Available_to_Plants[AMF,UR]+Water_Available_to_Plants[SAV,NE]+Water_Available_to_Plants[SAV,CR]+Water_Available_to_Plants[SAV,PA]+Water_Available_to_Plants[SAV,FA]+Water_Available_to_Plants[SAV,UR])
Total_Water_Waste = ARRAYSUM(WASTE_WATER[*,*])
Total_Transpiration =
(Transpiration[AMF,NE]+Transpiration[AMF,CR]+Transpiration[AMF,PA]+Transpiration[AMF,FA]+Transpiration[AMF,UR]+Transpiration[SAV,NE]+Transpiration[SAV,CR]+Transpiration[SAV,PA]+Transpiration[SAV,FA]+Transpiration[SAV,UR])
T_Ground_Water_Use = ARRAYSUM(Ground_Water_Use[AMF,*])+ARRAYSUM(Ground_Water_Use[SAV,*])+ARRAYSUM(Ground_Water_Use[RIV,*])+ARRAYSUM(Ground_Water_Use[FLF,*])
T_Surface_Water_Use = (ARRAYSUM(Surface_Water_Use[AMF,*])+ARRAYSUM(Surface_Water_Use[SAV,*])+ARRAYSUM(Surface_Water_Use[RIV,*])+ARRAYSUM(Surface_Water_Use[FLF,*]))
Unsaturated_Capilarity[LandCovers,LandUses] =
(AmazonLand[LandCovers,LandUses]*1E6*(•Soil_Depth[LandCovers,LandUses]*•Soil_Porosity[LandCovers,LandUses]))/Erosion_Effect_on_Soil_Capilarity[LandCovers,LandUses]
Upstream__Waters[AMF,NE] = 0
Upstream__Waters[AMF,CR] = 0
Upstream__Waters[AMF,PA] = 0
Upstream__Waters[AMF,FA] = 0
Upstream__Waters[AMF,UR] = 0
Upstream__Waters[SAV,NE] = 0
Upstream__Waters[SAV,CR] = 0
Upstream__Waters[SAV,PA] = 0
Upstream__Waters[SAV,FA] = 0
Upstream__Waters[SAV,UR] = 0
Upstream__Waters[RIV,NE] = 1.5E9
Upstream__Waters[RIV,CR] = 0
Upstream__Waters[RIV,PA] = 0
Upstream__Waters[RIV,FA] = 0
Upstream__Waters[RIV,UR] = 0
Upstream__Waters[FLF,NE] = 0
Upstream__Waters[FLF,CR] = 0
Upstream__Waters[FLF,PA] = 0
Upstream__Waters[FLF,FA] = 0
Upstream__Waters[FLF,UR] = 0

Water_Available_to_Plants[LandCovers, LandUses] = (•Soil_Moisture_FC[LandCovers, LandUses]-
 •Soil_Moisture_WP[LandCovers, LandUses])*Unsaturated_Capilarity[LandCovers, LandUses]*Root_Depth[LandCovers, LandUses]
 Water_Depth[LandCovers, LandUses] = IF AmazonLand[LandCovers, LandUses] =0 THEN 0 ELSE
 SURFACE_WATER[LandCovers, LandUses]/(AmazonLand[LandCovers, LandUses]*1E9)
 Water_into_Rivers[AMF, NE] = 0.75
 Water_into_Rivers[AMF, CR] = 0.35
 Water_into_Rivers[AMF, PA] = 0.35
 Water_into_Rivers[AMF, FA] = 0.35
 Water_into_Rivers[AMF, UR] = 0.35
 Water_into_Rivers[SAV, NE] = 0.35
 Water_into_Rivers[SAV, CR] = 0.35
 Water_into_Rivers[SAV, PA] = 0.35
 Water_into_Rivers[SAV, FA] = 0.35
 Water_into_Rivers[SAV, UR] = 0.35
 Water_into_Rivers[RIV, NE] = 1
 Water_into_Rivers[RIV, CR] = 0.35
 Water_into_Rivers[RIV, PA] = 0.35
 Water_into_Rivers[RIV, FA] = 0.35
 Water_into_Rivers[RIV, UR] = 0.35
 Water_into_Rivers[FLF, NE] = 0.35
 Water_into_Rivers[FLF, CR] = 0.35
 Water_into_Rivers[FLF, PA] = 0.35
 Water_into_Rivers[FLF, FA] = 0.35
 Water_into_Rivers[FLF, UR] = 0.35
 Water_Produced = (ARRAYSUM(Water_Use[AMF, *])+ARRAYSUM(Water_Use[SAV, *])+
 ARRAYSUM(Water_Use[RIV, *])+ARRAYSUM(Water_Use[FLF, *]))
 Water_Use[LandCovers, LandUses] =
 Ground_Water_Use[LandCovers, LandUses]+Surface_Water_Use[LandCovers, LandUses]
 •Evaporation_Rate[LandCovers, LandUses] = 0.002
 •IC_Ground_Water_Rate[LandCovers, LandUses] = 50
 •IC_Surf_Water_Rate[AMF, NE] = 0
 •IC_Surf_Water_Rate[AMF, CR] = 0
 •IC_Surf_Water_Rate[AMF, PA] = 0
 •IC_Surf_Water_Rate[AMF, FA] = 0
 •IC_Surf_Water_Rate[AMF, UR] = 0
 •IC_Surf_Water_Rate[SAV, NE] = 0
 •IC_Surf_Water_Rate[SAV, CR] = 0
 •IC_Surf_Water_Rate[SAV, PA] = 0
 •IC_Surf_Water_Rate[SAV, FA] = 0
 •IC_Surf_Water_Rate[SAV, UR] = 0
 •IC_Surf_Water_Rate[RIV, NE] = 40
 •IC_Surf_Water_Rate[RIV, CR] = 0
 •IC_Surf_Water_Rate[RIV, PA] = 0
 •IC_Surf_Water_Rate[RIV, FA] = 0
 •IC_Surf_Water_Rate[RIV, UR] = 0
 •IC_Surf_Water_Rate[FLF, NE] = 20
 •IC_Surf_Water_Rate[FLF, CR] = 0
 •IC_Surf_Water_Rate[FLF, PA] = 0
 •IC_Surf_Water_Rate[FLF, FA] = 0
 •IC_Surf_Water_Rate[FLF, UR] = 0
 •IC_Unsat_Water_Rate[AMF, NE] = 1E6
 •IC_Unsat_Water_Rate[AMF, CR] = 0.35
 •IC_Unsat_Water_Rate[AMF, PA] = 0.35
 •IC_Unsat_Water_Rate[AMF, FA] = 0.35
 •IC_Unsat_Water_Rate[AMF, UR] = 0.35

- IC_Unsat_Water_Rate[SAV,NE] = 0.35
- IC_Unsat_Water_Rate[SAV,CR] = 0.35
- IC_Unsat_Water_Rate[SAV,PA] = 0.35
- IC_Unsat_Water_Rate[SAV,FA] = 0.35
- IC_Unsat_Water_Rate[SAV,UR] = 0.35
- IC_Unsat_Water_Rate[RIV,NE] = 0
- IC_Unsat_Water_Rate[RIV,CR] = 0
- IC_Unsat_Water_Rate[RIV,PA] = 0
- IC_Unsat_Water_Rate[RIV,FA] = 0
- IC_Unsat_Water_Rate[RIV,UR] = 0
- IC_Unsat_Water_Rate[FLF,NE] = 0
- IC_Unsat_Water_Rate[FLF,CR] = 0
- IC_Unsat_Water_Rate[FLF,PA] = 0
- IC_Unsat_Water_Rate[FLF,FA] = 0
- IC_Unsat_Water_Rate[FLF,UR] = 0
- IC_Waste_Water_Rate[AMF,NE] = 0
- IC_Waste_Water_Rate[AMF,CR] = 1
- IC_Waste_Water_Rate[AMF,PA] = 1
- IC_Waste_Water_Rate[AMF,FA] = 1
- IC_Waste_Water_Rate[AMF,UR] = 1
- IC_Waste_Water_Rate[SAV,NE] = 1
- IC_Waste_Water_Rate[SAV,CR] = 1
- IC_Waste_Water_Rate[SAV,PA] = 1
- IC_Waste_Water_Rate[SAV,FA] = 1
- IC_Waste_Water_Rate[SAV,UR] = 1
- IC_Waste_Water_Rate[RIV,NE] = 0
- IC_Waste_Water_Rate[RIV,CR] = 0
- IC_Waste_Water_Rate[RIV,PA] = 0
- IC_Waste_Water_Rate[RIV,FA] = 0
- IC_Waste_Water_Rate[RIV,UR] = 1
- IC_Waste_Water_Rate[FLF,NE] = 0
- IC_Waste_Water_Rate[FLF,CR] = 0
- IC_Waste_Water_Rate[FLF,PA] = 0
- IC_Waste_Water_Rate[FLF,FA] = 0
- IC_Waste_Water_Rate[FLF,UR] = 0
- Perc_usable_water[LandCovers,LandUses] = 0.000001
- Pers_Recoverable_GrW[LandCovers,LandUses] = 1
- Runoff_Rate[LandCovers,LandUses] = 0.01
- Slope[LandCovers,LandUses] = 1
- Soil_Depth[LandCovers,LandUses] = 3.5
- Soil_Moisture_FC[LandCovers,LandUses] = 0.7
- Soil_Moisture_WP[LandCovers,LandUses] = 0.29
- Soil_Porosity[LandCovers,LandUses] = 0.42
- Transpiration_Rate[LandCovers,LandUses] = 2
- Upwelling_Rate[LandCovers,LandUses] = 1E-5
- Waste_Water_Assimilation[LandCovers,LandUses] = 1
- Welling_Rate[LandCovers,LandUses] = 0.001

Precipitation_by_LCLU[LandCovers,LandUses] = GRAPH(TIME)
(1975, 2.33), (1995, 2.28), (2015, 2.24), (2035, 2.21), (2055, 2.18), (2075, 2.14), (2095, 2.11), (2115, 2.09),
(2135, 2.06), (2155, 2.03), (2175, 2.00)

WellBeingWithinSectorAnthrosphere

Build_Cap_value[Optimistic] =

(•W_Build_Capital_Exp[Optimistic]*Welfare[Optimistic])/Max(1,BUILT_CAPITAL)

Build_Cap_value[Skeptic] =

(•W_Build_Capital_Exp[Skeptic]*Welfare[Skeptic])/Max(1,BUILT_CAPITAL)

Consumption_MCW[Optimistic] =
(•W_Cons_Exp[Optimistic]*Welfare[Optimistic])/Max(1,GS_Personal_Consumption)
Consumption_MCW[Skeptic] =
(•W_Cons_Exp[Skeptic]*Welfare[Skeptic])/Max(1,GS_Personal_Consumption)
Economy_values[T_outlook] =
Build_Cap_value[T_outlook]+Knowledge_value[T_outlook]+Social_Cap_Value[T_outlook]
Knowledge_value[Optimistic] =
(•W_Knowledge_Exp[Optimistic]*Welfare[Optimistic])/Max(1,Knowledge)
Knowledge_value[Skeptic] = (•W_Knowledge_Exp[Skeptic]*Welfare[Skeptic])/Max(1,Knowledge)
MCW_EcoS[EcoService_Type,T_outlook] =
(•W_EcoSer_Exp[EcoService_Type,T_outlook]*Welfare[T_outlook])/Max(1,TECOservices[EcoService_Type])
Regional_Welfare = (•Percent_optimists*Welfare[Optimistic])+((1-•Percent_optimists)*Welfare[Skeptic])
Social_Cap_Value[T_outlook] =
(•W_SC_Exp[T_outlook]*Welfare[T_outlook])/Max(1,SOCIAL_NETWORK)
Waste_Value[Optimistic] = IF Welfare[Optimistic]=0 THEN 0 ELSE
WASTE/((•W_Waste_Exp[Optimistic]+•W_Cons_Exp[Optimistic])*Welfare[Optimistic])
Waste_Value[Skeptic] = IF Welfare[Skeptic]=0 THEN 0 ELSE
WASTE/((•W_Waste_Exp[Skeptic]+•W_Cons_Exp[Skeptic])*Welfare[Skeptic])
Welfare[T_outlook] =
Welfare_from_EcoS[T_outlook]*Welfare_from_Human_Made_Capital[T_outlook]*Welfare_from_Consumption[T_outlook]*Welfare_from_Mortality[T_outlook]*Welfare_from_Waste[T_outlook]
Welfare_from_Consumption[T_outlook] =
(GS_Personal_Consumption/•Max_Cons_Welfare)^•W_Cons_Exp[T_outlook]
Welfare_from_EcoS[T_outlook] =
(Welfare_Terms_EcoS[Rec_Cult,T_outlook]*Welfare_Terms_EcoS[Gas_Regul,T_outlook]*Welfare_Terms_EcoS[Climate_Regul,T_outlook]*Welfare_Terms_EcoS[Dist_Regul,T_outlook]*Welfare_Terms_EcoS[Waste_Ass_Pot,T_outlook]*Welfare_Terms_EcoS[Nutrient_Uptake,T_outlook])
Welfare_from_Human_Made_Capital[T_outlook] =
Welfare_Term_Built[T_outlook]*Welfare_Term_knowledge[T_outlook]*Welfare_Term_Social[T_outlook]
Welfare_from_Mortality[Optimistic] = IF Mortality_Rate=0 THEN 0 ELSE
Mortality_Rate^•W_Mortality_Exp[Optimistic]
Welfare_from_Mortality[Skeptic] = IF Mortality_Rate=0 THEN 0 ELSE
Mortality_Rate^•W_Mortality_Exp[Skeptic]
Welfare_from_Waste[Optimistic] =
MAX(0,((WASTE/•Max_Waste_welfare)^•W_Waste_Exp[Optimistic]))
Welfare_from_Waste[Skeptic] = MAX(0,((WASTE/•Max_Waste_welfare)^•W_Waste_Exp[Skeptic]))
Welfare_Per_Capita = IF Amazon_Population=0 THEN 0 ELSE Regional_Welfare/(Amazon_Population)
Welfare_per_GRP = IF GRP=0 THEN 0 ELSE (Welfare_Per_Capita*1e6)/(GRP*1e9)
Welfare_per_GS_Econ_Prod = IF GS_Econ_Prod=0 THEN 0 ELSE Welfare_Per_Capita/GS_Econ_Prod
Welfare_Terms_EcoS[EcoService_Type,T_outlook] =
(TECOservices[EcoService_Type]/•Max_EcoS_welfare[EcoService_Type])^•W_EcoSer_Exp[EcoService_Type,T_outlook]
Welfare_Term_Built[Optimistic] =
(BUILT_CAPITAL/•Max_Built_Welfare)^•W_Build_Capital_Exp[Optimistic]
Welfare_Term_Built[Skeptic] =
(BUILT_CAPITAL/•Max_Built_Welfare)^•W_Build_Capital_Exp[Skeptic]
Welfare_Term_knowledge[Optimistic] =
(Knowledge/•Max_Know_welfare)^•W_Knowledge_Exp[Optimistic]
Welfare_Term_knowledge[Skeptic] = (Knowledge/•Max_Know_welfare)^•W_Knowledge_Exp[Skeptic]
Welfare_Term_Social[T_outlook] = (SOCIAL_NETWORK/•Max_SC_welfare)^•W_SC_Exp[T_outlook]
W_return_to_scale[T_outlook] =
ARRAYSUM(•W_EcoSer_Exp[*],T_outlook]+•W_Cons_Exp[T_outlook]+•W_Knowledge_Exp[T_outlook]+•W_SC_Exp[T_outlook]+•W_Waste_Exp[T_outlook]+•W_Build_Capital_Exp[T_outlook]+•W_Mortality_Exp[T_outlook]

- Max_Built_Welfare = 50
- Max_Cons_Welfare = 100
- Max_EcoS_welfare[Rec_Cult] = 150
- Max_EcoS_welfare[Gas_Regul] = 150
- Max_EcoS_welfare[Climate_Regul] = 200
- Max_EcoS_welfare[Dist_Regul] = 150
- Max_EcoS_welfare[Waste_Ass_Pot] = 10
- Max_EcoS_welfare[Nutrient_Uptake] = 150
- Max_EcoS_welfare[Org_Soil_Form] = 100
- Max_Know_welfare = 10
- Max_SC_welfare = 10
- Max_Waste_welfare = 100
- Percent_optimists = .5
- W_Build_Capital_Exp[Optimistic] = 1
- W_Build_Capital_Exp[Skeptic] = 1
- W_Cons_Exp[Optimistic] = 0.6
- W_Cons_Exp[Skeptic] = 0.4
- W_EcoSer_Exp[Rec_Cult,Optimistic] = 1
- W_EcoSer_Exp[Rec_Cult,Skeptic] = 1
- W_EcoSer_Exp[Gas_Regul,Optimistic] = 1
- W_EcoSer_Exp[Gas_Regul,Skeptic] = 1
- W_EcoSer_Exp[Climate_Regul,Optimistic] = 1
- W_EcoSer_Exp[Climate_Regul,Skeptic] = 1
- W_EcoSer_Exp[Dist_Regul,Optimistic] = 1
- W_EcoSer_Exp[Dist_Regul,Skeptic] = 1
- W_EcoSer_Exp[Waste_Ass_Pot,Optimistic] = 1
- W_EcoSer_Exp[Waste_Ass_Pot,Skeptic] = 1
- W_EcoSer_Exp[Nutrient_Uptake,Optimistic] = 1
- W_EcoSer_Exp[Nutrient_Uptake,Skeptic] = 1
- W_EcoSer_Exp[Org_Soil_Form,Optimistic] = 1
- W_EcoSer_Exp[Org_Soil_Form,Skeptic] = 1
- W_Knowledge_Exp[Optimistic] = 1
- W_Knowledge_Exp[Skeptic] = 1
- W_Mortality_Exp[Optimistic] = 1
- W_Mortality_Exp[Skeptic] = 1
- W_SC_Exp[Optimistic] = 1
- W_SC_Exp[Skeptic] = 1
- W_Waste_Exp[Optimistic] = 0.6
- W_Waste_Exp[Skeptic] = 0.4

Not in a sector

References

- Achard, F., Eva, H.D., Stibig, H.-S., Mayaux, P., Gallego, J., Richards, T., Malingreau J.-P., 2002. Determination of deforestation rates of the world's Humid tropical forests. *Science* 297, 999-1002.
- Allen, J.C., 1985. Soil responses to forest clearing in the United States and the Tropics: Geological and Biological Factor. *Biotropica* 17, 15-27.
- Allen, T.F.H., Hoekstra, T.W., 1992. Introduction. In: Allen, T. F. H. and Roberts, D. W., editors (Eds.). *Toward a Unified Ecology*. Columbia University Press, New York, p. 13-49.
- Alves, D.S., 1999. An analysis of the geographical patterns of deforestation in Brazilian Amazonia in the 1991-1996 period. In: 48th Annual Conference Patterns and Processes of Land Use and Forest Change in the Amazon, Center for Latin American Studies, University of Florida.
- Andersen, L.E., 1996. The causes of deforestation in the Brazilian Amazon. *Journal of Environment and Development* 5, 309-328.
- Andersen, L.E. 1997. A cost-benefit analysis of deforestation in the Brazilian Amazon. *Texto para discussao, IPEA/DIPES*. Rio de Janeiro, Brazil.
- Andersen, L.E., Granger, C.W.J., Huang, L.-L., Reis, E.J., Weinhold, D., 1996. Report on Amazon deforestation. Discussion Paper 96-40. University of California, San Diego, 1-133.
- Andersen, L.E., Granger, C.W.J., Reis, E., Weinhold, D., Wunder, S., 2002. *The Dynamics of Deforestation and Economic Growth in the Brazilian Amazon*. Cambridge University Press, Cambridge, UK, p. 259.
- Andersen, L.E., Reis, E.J., 1997. Deforestation, development, and government policy in the Brazilian Amazon: An econometrics analysis. *Texto para Discussao N. 513*. IPEA, 1-24.
- Andreae, M.O., Almeida, S.S., Artaxo, P., Brandão, C., Carswell, F.E., Ciccioli, P., Culf, A., Esteves, J.L., Gash, J., Grace, J., Kabat, P., Lelieveld, J., Malhi, Y., Manzi, A.O., Meixner, F.X., Nobre, A., Nobre, C., Ruivo, M.A.L., Silva-Dias, M.A., Stefani, P., Valentini, R., Jouanne, J., Waterloo, M., 2002. Biogeochemical cycling of carbon, water, energy, trace gases and aerosols in Amazonia: The LBA-EUSTACH experiments. *Journal of Geophysical Research Atmospheres* 107, 33: 31- 25 (doi:10.1029/2001JD000524).
- Andreae, M.O., Artaxo, P., Brandao, C., Carswell, F.E., Ciccioli, P., da Costa, A.L., Culf, A.D., Esteves, J.L., Gash, J.H.C., Grace, J., Kobat, P., Lelieveld, J., Malhi, Y., Manzi, A.O., Meixner, F.S., Nobre, A.D., Nobre, C., Ruivo, M.d.L.P., Silva-Dias,

- M.A., Stefani, P., Valentini, R., von Jouanne, J., Waterloo, M.J., 2002. Biogeochemical Cycling of Carbon, Water, Energy, Trace Gases and Aerosols in Amazonia: The LBA EUSTACH experiments. In: Kabat, P., Andreae, M. O., Silva-Dias, M. A., Veraart, J. A., and Bink, N. J., editors (Eds.). *The Amazon Region: Tropical Deforestation, Biogeochemical Cycles and the Climate*. Report no. 410 200 125. Dutch National Programme on Global Air Pollution and Climate Change, p. 2-44.
- Asner, G.P., Seastedt, T.R., Townsend, A.R., 1997. The decoupling of terrestrial Carbon and Nitrogen cycles. *BioScience* 47, 226-233.
- Asquith, N.M., Rios, M.T.V., Smith, J., 2002. Can forest-protection carbon projects improve rural livelihoods? Analysis of the Noel Kempff Mercado Climate Action Project, Bolivia. *Mitigation and Adaptation Strategies for Global Change* 7, 323-337.
- Ayanaba, A., 1976. The effects of clearing and cropping on the organic reserves and biomass of tropical forest soils. *Soil Biol. Biochem.* 8, 519-525.
- Barbier, E.B., 1994. Natural Capital and the Economics of Environment and Development. In: Jansson, A., Hammer, M., Folke, C., and Costanza, R., editors (Eds.). *Investing in Natural Capital: The Ecological Economics Approach to Sustainability*. Island Press, Washington, D.C., p. 291-322.
- Barbier, E.B., Burgess, J.C., Markandya, A., 1991. The economics of tropical deforestation. *Ambio* 20 (2), 55-58.
- Barbosa, R.I., Fearnside, P.M., 1999. Incendios na Amazonia Brasileira: Estimativa da emissao de gases do efeito estufa pela queima de diferentes ecossistemas de Roraima na passagem do evento "El Niño" (1997/98). *Acta Amazonica* 29, 513-534.
- Barbosa, R.I., Fearnside, P.M., 2000. Erosao do solo na Amazonia: Estudo de caso na regio do Apiau, Roraima, Brazil. *Acta Amazonica* 30, 601-613.
- Barlow, J., Peres, C.A., Lagan, B.O., Haugaasen, T., 2003. Large tree mortality and the decline of forest biomass following Amazonian wildfires. *Ecology Letters* 6, 6-8.
- Barnes, B.V., Zak, D.R., Denton, S.R., Spurr, S.H., 1998. *Forest Ecology*, 4th edition. John Wiley & Sons, Inc., New York, p. 774.
- Bartlett, K.B., Crill, P.M., Bonassi, J.A., Richey, J.E., Harriss, R.C., 1990. Methane flux from the Amazon River floodplain: Emissions during rising water. *Journal of Geophysical Research* 95, 16733-16788.

- BCB. 2004. Annual Average Exchange Rate: Historical Series 1941 - 2003. Excell File. Banco Central do Brasil.
- Becker, B.K., 1995. Undoing myths: The Amazon _ An Urbanized Forest. In: Clusener-Godt, M. and Sachs, I., editors (Eds.). *Brazilian Perspectives on Sustainable Development of the Amazon Region*. Unesco Paris and The Parthenon Publishing Group: Internation Publishers in Science, Technology & Education, Paris, France, p. 53-89.
- Beers, S., 1998. Blame it to El Niño. *The Environment Magazine* 9, 22-24.
- Bennett, E.M., Carpenter, S.R., Peterson, G.D., Cumming, G.S., Zurek, M., Pingali, P., 2003. Why global scenarios need ecology. *Frontiers in Ecology and the Environment* 1, 322-329.
- Berkes, F., Folke, C., 1994. Investing in Cultural Capital for Sustainable Use of Natural Capital. In: Jansson, A., Hammer, M., Folke, C., and Costanza, R., editors (Eds.). *Investing in Natural Capital: The Ecological Economics Approach to Sustainability*. Island Press, Washington, D.C., p. 128-149.
- Bernoux, M., Arrouays, D., Cerri, C., Volkoff, B., Jolivet, C., 1998. Bulk densities of Brazilian Amazon soils related to other soil properties. *Soil Science Society of America Journal* 62, 743-749.
- Bernoux, M., Graça, P.M.A., Cerri, C.C., Fearnside, P.M., Feigl, B.J., Piccolo, M.C., 2001. Carbon Storage in Biomass and Soils. In: McClain, M. E., Victoria, R., and Richey, J. E., editors (Eds.). *The Biogeochemistry of the Amazon Basin*. Oxford University Press, New York, p. 165-184.
- Bishop, J., Landell-Mills, N., 2002. Forest Environmental Services: An Overview. In: Pagiola, S., Bishop, J., and Landell-Mills, N., editors (Eds.). *Selling Forest Environmental Services: Market-Based Mechanisms for Conservation and Development*. Earthscan Publications Ltd., Sterling, VA, p. 15-35.
- BLS. 2004. Inflation Calculator. US Department of Labor/Bureau of Labor Statistics. 2004. Downloaded from www.bls.org on 03/10/04.
- Bockstael, N., Costanza, R., Strand, I., Boynton, W., Bell, K., Wainger, L., 1995. Ecological economic modeling and valuation of ecosystems. *Ecological Economics* 14, 143-159.
- Bonnie, R., Carey, M., Petksonk, A., 2002. Protecting terrestrial ecosystems and the climate through a global carbon market. *Philosophical Transactions of the Royal Society of London Series A* 360, 1853-1873.

- Born, S.M., Sonzogni, W.C., 1995. Integrated environmental management: Strengthening the conceptualization. *Environmental Management* 19, 167-181.
- Boumans, R., Costanza, R., Farley, J., Wilson, M.A., Portela, R., Villa, F., Rothmans, J., Grasso, M., 2002. Modeling the dynamics of the integrated earth system and the value of global ecosystem services using GUMBO model. *Ecological Economics* 41, 529-560.
- Brandt, J., 1988. The transformation of rainfall energy by a tropical rain forest in relation to soil erosion. *Journal of Biogeography* 15, 41-48.
- Brasil, 1965. Lei n 4471, de 15 de setembro de 1965. Institui o Novo Código Florestal. *Diário Oficial da União, Brasília*, p. 9529, 16 set. 1965 [retificado em 20 set. 1965, p. 9513].
- Brasil, 2001. Medida Provisória n 2166-67. Altera os artigos 1,4,14,16 e 44, e acresce dispositivos a Lei 4771, de 15 de setembro de 1965, que institui o código florestal, bem como altera o artigo 10 da Lei 9393, de 19 de dezembro de 1996, que dispõe sobre o imposto sobre a propriedade territorial rural - ITR, e dá outras providências. *Diário Oficial da União, Brasília*, p.1, 25 ago. 2001.
- Brasil, 2004. Plano de Ação para a Prevenção e Controle do Desmatamento na Amazonia Legal. Grupo Permanente de Trabalho Interministerial para a Redução dos Índices de Desmatamento na Amazonia Legal. Presidência da República. Casa Civil, Brasília, DF, Brazil.
- Brooks, K.N., Ffolliott, P.F., Gregersen, H.M., DeBano, L.F., 1997. *Hydrology and the Management of Watersheds*, 2nd edition. Iowa State university Press, Ames, Iowa, p. 502.
- Brown, S., Burnham, M., Delaney, M., Powell, M., Vaca, R., Moreno, A., 2000. Issues and challenges for forest-based carbon-offset projects: A case study of the Noel Kempff Climate Action Project in Bolivia. *Mitigation and Adaptation Strategies for Global Change* 5, 99-121.
- Brown, S., Gillespie, A.J.R., Lugo, A.E., 1989. Biomass estimation methods for tropical forest with applications to forest inventory data. *Forest Science* 35, 881-902.
- Brown, S., Lugo, A.E., 1982. The storage and production of organic matter in tropical forests and their role in the global carbon cycle. *Biotropica* 14, 161-187.
- Brown, S., Lugo, A.E., 1984. Biomass of tropical forest: A new estimate based on forest volume. *Science* 223, 1290-1293.

- Brown, S., Lugo, A.E., 1990. Effects of forest clearing and succession on the carbon and nitrogen content of soils in Puerto Rico and US Virgin Islands. *Plant Soil* 124, 53-64.
- Brown, S., Lugo, A.E., 1992. Aboveground biomass estimates for tropical moist forests of the Brazilian Amazon. *Interciencia* 17, 8 -18.
- Bruijnzeel, L.A., 1991. Nutrient input-output budgets of tropical forest ecosystems: A review. *Journal of Tropical Ecology* 7, 1-24.
- BSRCI. 2004. Tropical Rain Forest Information Center. File TRFIC Map Products Library Brazilian Amazon Windows Enhanced MEtafiles (.emf). Downloaded on 01/19/04 from http://www.bsrsi.msu.edu/trfic/products/Amazon_products/Amazonmaps_emf.html.
- Bunyard, P., 1987. Dam Building in the Tropics: Some Environmental Social Consequences. In: Dickinson, R. E., (Ed.). (Eds.). *The Geophysics of Amazonia: Vegetation and Climate Interactions*. Wiley & Sons, New York, NY, p. 63-68.
- Burgos, J.J., Ponce, H.F., Molion, L.C.B., 1991. Climate change predictions for South America. *Climatic Chage* 18, 223-239.
- Buschbacher, R.J., 1986. Tropical deforestation and pasture development: We can still conserve and rationally develop the largest remaining region of intact tropical forest. *BioScience* 36, 22-28.
- Carvalho, G., Barros, A.C., Moutinho, P., Nepstad, D.C., 2001. Sensitive development could protect Amazonia instead of destroying it. *Nature* 409, 131.
- Cattaneo, A., 2001. Deforestation in the Brazilian Amazon: Comparing the impacts of macroeconomic shocks, land tenure, and technological change. *Land Economics* 77, 219-240.
- Cattaneo, A. 2002. *Balancing Agricultural Development and Deforestation in the Brazilian Amazon*. International Food Policy Research Institute, Washington, DC.
- Cerri, C.C., Bernoux, M., Arrouays, D., Feigl, B.J., Piccolo, M.C., 2000. Carbon Stocks in Soils of the Brazilian Amazon. In: Lal, R., Kimble, J. M., and Stewart, B. A., editors (Eds.). *Global Climate Change and Tropical Ecosystems*. CRC Press, Boca Raton, p. 33-50.
- Chambers, J.Q., dos Santos, J., Ribeiro, R.J., Higuchi, N., 2000. Tree damage, allometric relationships, and above-ground net primary production in central Amazon forest. *Forest Ecology and Management* 5348, 1-12.

- Chomitz, K.M., Brenes, E., Costantino, L., 1999. Financing environmental services: The Costa Rican experience and its implications. *The Science of the Total Environment* 240, 157-169.
- Chomitz, K.M., Thomas, S.T., 2001. Geographic patterns of land use and land intensity in the Brazilian Amazon.
- Clark, D.A., 2002. Are tropical forests an important carbon sink? *Ecological Applications* 12, 3-7.
- Clark, D.B., Clark, D.A., 2002. Landscape-scale variation in forest structure and biomass in a tropical rain forest. *Forest Ecology and Management* 137, 185-198.
- Cleveland, C.J., Ruth, M., 1997. When, where, and by how much do biophysical limits constrain the economic process? A survey of Nicholas Georgescu-Roegen's contribution to ecological economics. *Ecological Economics* 22, 203-223.
- Cochrane, M.A., 2003. Fire science for rainforests. *Science* 421, 913-919.
- Cochrane, M.A., Alencar, A., Schulze, M.D., Jr., C.M.S., Nepstad, D.C., Lefebvre, P., Davidson, E.A., 1999. Positive Feedbacks in the Fire Dynamic of Closed Canopy Tropical Forests. *Science* 284, 1832-1835.
- Cochrane, M.A., Schulze, M.D., 1998. Fire in the Brazilian Amazon. *Conservation Biology* 12, 948-950.
- Constantino, L., 2004. Desmatamento na Amazonia em 2003 supera 21 mil km². Folha de Sao Paulo. Downloaded on 04/07/04 from <http://ww1.folha.uol.com.br/folha/ciencia/ult306u11500.shtml>.
- Cornwell, L., Costanza, R., 1999. Environmental Bonds: Implementing the Precautionary Principle in Environmental Policy. In: Raffensperger, C. and Tickner, J. A., editors (Eds.). *Protecting Public Health & the Environment: Implementing the Precautionary Principle*. Island Press, Washington, DC, p. 220-240.
- Costa, M.H., Foley, J.A., 2000. Combined effects of deforestation and double atmospheric CO₂ concentrations on the climate of Amazonia. *Journal of Climate* 13, 18-34.
- Costa, M.H., Oliveira, C.H.C., Andrade, R.G., Bustamante, T.R., Silva, F.A.A., Coe, M.T., 2002. A macroscale hydrological data set of river flow routing parameters for the Amazon Basin. *Journal of Geophysical Research-Atmospheres* 107, 6: 1-9 (doi: 10.1029/2000JD000309).
- Costanza, R., 1987. Social traps and environmental policy: Why do problems persist where there are technical solutions available. *BioScience* 37, 407-412.

- Costanza, R., 1996a. Ecological Economics: Reintegrating the study of humans and nature. *Ecological Applications* 6, 978-990.
- Costanza, R., 1996b. The impact of ecological economics. *Ecological Economics* 19, 1-2.
- Costanza, R., Arge, R., Groot, R., Farber, S., Grasso, M., Hannon, B., Limburg, K., Naeem, S., O'Neill, R.V., Paruelo, J., Raskin, R.R., Sutton, P., Belt, M.v.d., 1997. The value of the world's ecosystems services and natural capital. *Nature* 387, 253-269.
- Costanza, R., Boumans, R., Sahagian, D., 2003. A new approach to global, dynamic modeling of integrated human in natural systems. *IGBP Newsletter* 54, 9-12.
- Costanza, R., Cuberland, J., Daly, H., Goodland, R., Norgard, R., 1997. An Introduction to Ecological Economic. CRC Press LLC, Boca Raton, FL., p. 275.
- Costanza, R., d'Arge, R., Groot, R.d., Farber, S., Grasso, M., Hannon, B., Limburg, K., Naeem, S., O'Neill, R.V., Paruelo, J., Raskin, R.R., Sutton, P., Belt, M.v.d., 1997. The value of the world's ecosystem services and natural capital. *Nature* 387, 253-260.
- Costanza, R., Maxwell, T., 1994. Resolution and predictability: An approach to the scaling problem. *Landscape Ecology* 9, 47-57.
- Costanza, R., Ruth, M., 1998. Using dynamic modeling to scope environmental problems and build consensus. *Environmental Management* 22, 183-195.
- Costanza, R., Sklar, F.H., 1985. Articulation, accuracy and effectiveness of mathematical models: A review of freshwater wetland applications. *Ecological Modelling* 27, 45-68.
- Costanza, R., Sklar, F.H., White, M.L., 1990. Modeling coastal landscape dynamics: Process-based dynamic spatial ecosystem simulation can examine long-term natural changes and human impacts. *BioScience* 40, 91-107.
- Costanza, R., Voinov, A., 2001. Modeling ecological and economic systems with STELLA: Part III. *Ecological Modeling*, 143, 1-7.
- Costanza, R., Voinov, A., Boumans, R., Maxwell, t., Villa, F., Wainger, L., Voinov, H., 2002. Integrated ecological economic modeling of the Patuxent River watershed, Maryland. *Ecological Monographs* 72, 203-231.
- Costanza, R., Waigner, L., Folke, C., Maler, K.-G., 1993. Modeling complex ecological and economic systems: Toward an evolutionary, dynamic understanding of people and nature. *BioScience* 43, 545-555.

- Costanza, R., Wainger, L., Bockstael, N., 1996. Integrating Spatially Explicit Ecological Economics Models. In: Costanza, R., Segura, O., and Martinez-Alier, J., editors (Eds.). *Getting Down to Earth: Practical Applications of Ecological Economics*. Island Press, Washington, DC, p. 250-284.
- Coutinho, L.M., 1982. Ecological Effects of Fire in Brazilian Cerrado. In: Huntley, B. J. and Walker, B. H., editors (Eds.). *Ecology of Tropical Savannas*. Springer-Verlag, New York, p. 273-291.
- Crook, C., Clapp, R.A., 1998. Is market-oriented forest conservation a contradiction in terms? *Environmental Conservation* 25, 131-145.
- Crutzen, P.J., Andreae, M.O., 1990. Biomass burning in the tropics: Impact on atmospheric chemistry and biogeochemical cycles. *Science* 250, 1669-1678.
- Cuevas, E., Medina, E., 1986. Nutrient dynamics within Amazonian forest ecosystems: I. Nutrient flux in fine litter and efficiency of nutrient utilization. *Oecologia* 68, 466-472.
- Cuevas, E., Medina, E., 1988. Nutrient dynamics within Amazonian forest ecosystems: II. Fine root growth, nutrient availability and leaf litter decomposition. *Oecologia* 76, 222-235.
- Cunningham, W.P., Saigo, B.W., 1995. *Environmental Science: A Global Concern*. Wm. C. Brown Publishers, Dubuque, IA, p. 612.
- da Rocha, H.R., Nobres, C.A., Bonatti, J., Wright, I.R., Sellers, P.J., 1996. A vegetation-atmosphere interaction study for Amazonia deforestation using field data and a 'single column' model. *Quarterly Journal Royal Meteorological Society* 122, 567-594.
- Daily, G.C., 1997. Introduction: What Are Ecosystem Services? In: *Nature's Services: Societal Dependence on Natural Ecosystems*. Island Press, Washington, D.C., p. 1-10.
- Dale, V.H., 1997. The relationship between land-use change and climate change. *Ecological Applications* 7, 753: 769.
- Dale, V.H., O'Neill, R.V., Southworth, F., Pedlowski, M., 1994. Modeling effects of land management in the Brazilian Amazonian settlement of Rondonia. *Conservation Biology* 8, 196-206.
- Dale, V.H., Pearson, S.M., Offerman, H.L., O'Neill, R.V., 1994. Relating patterns of land-use change to faunal biodiversity in the central Amazon. *Conservation Biology* 12, 1027-1036.

- Dale, V.H., Winkle, W.V., 1998. Models provide understanding, not belief. *ESA Bulletin* 79, 69-170.
- Daly, H., 1994. Operationalizing Sustainable Development by Investing in Natural Capital. In: Jansson, A., Hammer, M., Folke, C., and Costanza, R., editors (Eds.). *Investing in Natural Capital: The Ecological Economics Approach to Sustainability*. Island Press, Washington, DC., p. 22-37.
- Daly, H., 1996. Introduction to Essays toward a Steady-State Economy. In: Daly, H. and Townsend, K. N., editors (Eds.). *Valuing the Earth: Economics, Ecology, Ethics*. The MIT Press, Cambridge, Massachusetts, p. 11-47.
- Daly, H., 1996. The Steady-State Economy: Toward a Political Economy of Biophysical Equilibrium and Moral Growth. In: Daly, H. and Townsend, K. N., editors (Eds.). *Valuing the Earth: Economics, Ecology, Ethics*. The MIT Press, Cambridge, Massachusetts, p. 11-47.
- Daly, H., 1999. *Ecological Economics and the Ecology of Economics: Essays in Criticism*. Edward Elgar Publishing, Northampton, MA, p. 191.
- Daly, H., Farley, J., 2003. *Ecological Economics: Principles and Applications*. Island Press, Washington, DC, p. 488.
- de Almeida, A.L.O., Campari, J.S., 1995. Sustainable Settlement in the Brazilian Amazon. The World Bank, Washington, DC, p. 189.
- de Groot, R.S., 1994. Environmental Functions and the Economic Value of Natural Ecosystems. In: Jansson, A., Hammer, M., Folke, C., and Costanza, R., editors (Eds.). *Investing in Natural Capital: The Ecological Economics Approach to Sustainability*. Island Press, Washington, D.C., p. 151-168.
- De Jong, B.H.J., Tipper, R., Montoya-Gomez, G., 2000. An economic analysis of the potential for carbon sequestration by forests: Evidence from Southern Mexico. *Ecological Economics* 33, 313-327.
- DeFries, r.S., Houghton, R.A., Hansen, M.C., Field, C.B., Skole, D., Townshend, J., 2002. Carbon emissions from tropical deforestation and regrowth based on satellite observations for the 1980s and 1990s. *PNAS* 99, 14256-14261.
- DeMaster, D.j., Aller, R.C., 2001. Biogeochemical Processes on the Amazon Shelf: Changes in Dissolved and Particulate Fluxes during River/Ocean Mixing. In: McClain, M. E., Victoria, R., and Richey, J. E., editors (Eds.). *The Biogeochemistry of the Amazon Basin*. Oxford University Press, New York, p. 328-357.

- Detwiler, R.P., Hall, C.A.S., 1988. Tropical forest and the global carbon cycle. *Science* 239, 42-47.
- Devol, A.H., Hedges, J.I., 2001. Organic Matter and Nutrients in the Mainstem Amazon River. In: McClain, M. E., Victoria, R., and Richey, J. E., editors (Eds.). *The Biogeochemistry of the Amazon Basin*. Oxford University Press, New York, p. 275-306.
- Devol, A.H., Quay, P.D., Richey, J.E., Martinelli, L.A., 1987. The role of gas exchange in the inorganic carbon, oxygen, and ²²²Rn budgets of the Amazon River. *Limnology and Oceanography* 32, 235-248.
- Devol, A.H., Richey, J.E., Clark, W.A., King, S.L., 1988. Methane emissions to the troposphere from the Amazon floodplain. *Journal of Geophysical Research* 93, 1583-1592.
- Devol, A.H., Richey, J.E., Forsberg, B.R., Martinelli, L.A., 1990. Seasonal dynamics in methane emissions from the Amazon River floodplain to the troposphere. *Journal of Geophysical Research* 95, 16417-16426.
- Dickinson, G., Murphy, K., 1998. *Ecosystems: A Functional Approach*, Routledge, New York, p. 190.
- Dickinson, R.E., 1987. Introduction to Vegetation and Climate Interactions in the Humid Tropics. In: Dickinson, R. E., (Ed.). (Eds.). *The Geophysiology of Amazonia: Vegetation and Climate Interactions*. Wiley & Sons, New York, NY, p. 3-10.
- Dickinson, R.E., Henderso-Sellers, A., 1988. Modelling tropical deforestation: A study of GCM land-surface parametrizations. *Quarterly Journal Royal Meteorological Society* 114, 439-462.
- Dickinson, R.E., Kennedy, P., 1992. Impacts on regional climate of Amazon deforestation. *Geophysical Research Letters* 19, 1947-1950.
- Dixon, R.K., Brown, S., Houghton, R.A., Solomon, A.M., Trexler, M.C., Wisniewski, J., 1994. Carbon pools and flux of global forest ecosystems. *Science* 263, 185-190.
- dos Santos, J.M., 1987. Climate, Natural Vegetation, and Soils in Amazonia: An Overview. In: Dickinson, R. E., (Ed.). (Eds.). *The Geophysiology of Amazonia: Vegetation and Climate Interactions*. Wiley & Sons, New York, NY, p. 25-36.
- Eden, M.J., McGregor, D.F.M., Vieira, N.A.Q., 1990. III. Pasture development on cleared forest land in northern Amazonia. *The Geographical Journal* 3, 283-296.
- EIA. 2003. Energy Information Administration. International Energy Outlook. Downloaded on 02/09/04 from http://www.eia.doe.gov/oiaf/ieo/tbl_c10.html.

- Eiten, G., 1982. Brazilian "Savannas". In: Huntley, B. J. and Walker, B. H., editors (Eds.). *Ecology of Tropical Savannas*. Springer-Verlag, New York, p. 25-47.
- Elzen, M.G.J., Beusen, H.w., Rotmans, J., Koster, H.W., 1997. The Biogeochemical Submodel: Cycles. In: Rotmans, J. and de Vries, B., editors (Eds.). *Perspectives on Global Change: The TARGETS approach*. Cambridge University Press, Cambridge, UK, p. 162-185.
- Engelbart, D.C., 1962. Augmenting human intellect: a conceptual framework. Menlo Park Menlo Park, CA, CA: Stanford Research Institute. (Summary report AFOSR-3233) Retrieved 30 December 2003 from <http://www.bootstrap.org/augdocs/friedewald030402/augmentinghumanintellect/ahi62index.html>.
- Erwin, T.L., 1988. The Tropical Forest Canopy. In: Wilson, E. O. and Peter, F. M., editors (Eds.). *Biodiversity*. National Academy Press, Washington, D.C., p. 123-129.
- Esteves, F.A., Enrich-Prast, A., Biesboer, D.D., 2001. Potential denitrification in submerged natural and impacted sediments of Lake Batata, an Amazonian lake. *Hydrobiologia* 444, 111-117.
- Faminow, M.D., 1997. Spatial economics of local demand for cattle products in Amazon development. *Agriculture, Ecosystems and Environment* 62, 1-11.
- Fan, W., Randolph, J.C., Ehman, J.L., 1998. Regional estimation of nitrogen mineralization in forest ecosystems using geographic information systems. *Ecological Applications* 8, 734-747.
- Farella, N., Lucotte, M., Louchouart, P., Roulet, M., 2001. Deforestation modifying terrestrial organic transport in the Rio Tapajos, Brazilian Amazon. *Organic Geochemistry* 32, 1443-1458.
- Farnworth, E.G., Tidrick, T.H., Smathers, W.M., Jordan, C.F., 1983. A synthesis of ecological and economic theory toward more complete valuation of tropical moist forests. *International Journal Environmental Studies* 21, 11-28.
- Fearnside, P.M., 1980. The effects of cattle pasture on soil fertility in the Brazilian Amazon: Consequences for beef production sustainability. *Tropical Ecology* 21, 125-137.
- Fearnside, P.M., 1987a. Causes of Deforestation in the Brazilian Amazon. In: Dickinson, R. E., (Ed.). (Eds.). *The Geophysiology of Amazonia: Vegetation and Climate Interactions*. Wiley & Sons, New York, NY, p. 36-60.

- Fearnside, P.M., 1987b. Deforestation and international economic development projects in Brazilian Amazonia. *Conservation Biology* 1, 214-221.
- Fearnside, P.M., 1988. An ecological analysis of predominant land uses in the Brazilian Amazon. *Environmentalist* 8, 281-300.
- Fearnside, P.M., 1992. Forest Biomass in Brazilian Amazonia: Comments on the estimate by Brown and Lugo. *Interciencia* 17, 19 -27.
- Fearnside, P.M., 1993a. Deforestation in Brazilian Amazonia: The effect of population and land tenure. *Ambio*, 537-545.
- Fearnside, P.M., 1993b. Biomass of Brazil's Amazonian Forests: Reply to Brown and Lugo revisited. *Interciencia* 18, 5-7.
- Fearnside, P.M., 1995. Potential impacts of climatic change on natural forests and forestry in Brazilian Amazonia. *Forest Ecology and Management* 78, 51-70.
- Fearnside, P.M., 1996. Amazonia deforestation and global warming: carbon stocks in vegetation replacing Brazil's Amazon forest. *Forest Ecology and Management* 80, 21-34.
- Fearnside, P.M., 1997a. Environmental services as a strategy for sustainable development in rural Amazonia. *Ecological Economics* 20, 53-70.
- Fearnside, P.M., 1997b. Greenhouse gases from deforestation in Brazilian Amazonia: Net committed emissions. *Climatic Change* 35, 321-360.
- Fearnside, P.M., 1997c. Wood density for estimating forest biomass in Brazilian Amazonia. *Forest Ecology and Management* 90, 59-89.
- Fearnside, P.M., 1999. Biodiversidade nas florestas Amazonicas Brasileiras: Riscos, Valores e Conservacao. *Revista Holos*, 33-59.
- Fearnside, P.M., 2003. Deforestation Control in Mato Grosso: A New Model for Slowing the Loss of Brazil's Amazon Forest. *Ambio* 32, 343-345.
- Fearnside, P.M., Guimaraes, W.M., 1996. Carbon uptake by secondary forest in Brazilian Amazonia. *Forest Ecology and Management* 80, 35-46.
- Fearnside, P.M., Laurance, W.F., 2002. O futuro da Amazonia: Os impactos do Programa Avanca Brasil. *Ciencia Hoje* 31, 61-65.
- Fenn, M.E., Poth, M.a., Aber, J.D., Baron, J.S., Bormann, B.T., Johnson, D.W., Lewly, A.D., McNulty, S.G., Ryan, D.F., Stottlemyer, R., 1998. Nitrogen excess in North

- American ecosystems: Predisposing factors, ecosystem responses, and management strategies. *Ecological Applications* 8, 706-733.
- Ferraz, C., 2001. Explaining agriculture expansion and deforestation: Evidence from the Brazilian Amazon - 1980/98. Texto para discussao N. 828. Instituto de Pesquisa Economica Aplicada. IPEA.
- Few, A.A., 1996. *System Behavior and System Modeling*. University Science Books, Sausalito, CA, p. 100.
- Fittkau, E.J., Irmler, U., Junk, W.J., Reiss, F., Schmidt, G.W., 1975. Productivity, Biomass, and Population dynamics in Amazonian Water Bodies. In: Golley, F. B. and Medina, E., editors (Eds.). *Tropical Ecological Systems: Trends in Terrestrial and Aquatic Research*. Springer-Verlag New York Inc., New York, NY, p. 289-311.
- Fittkau, E.J., Klinge, H., 1973. On biomass and trophic structure of the Central Amazonian rain forest ecosystem. *Biotropica* 5, 2-14.
- Ford, A., 1999. *Modeling the Environment: An Introduction to System Dynamics Models of Environmental Systems*. Island Press, Washington, DC, p. 401.
- Forsberg, B., Godoy, J.M., Victoria, R., Martinelli, L.A., 1989. Spatial and temporal variations in soil chemistry on the Amazon floodplain. *Geojournal* 19.1, 45-52.
- Forsberg, B.R., Devol, A.H., Richey, J.E., Martinelli, L.A., dos Santos, H., 1988. Factors controlling nutrient concentrations in Amazon floodplain lakes. *Limnology and Oceanography* 33, 41-56.
- Franken, M., 1979. Major nutrient and energy contents of the litterfall of a riverine forest of Central Amazonia. *Tropical Ecology* 20, 211-224.
- Gaillardet, J., Dupre, B., Allegre, C.J., Negrel, P., 1997. Chemical and physical denudation in the Amazon River basin. *Chemical Geology* 142, 141-173.
- Garcia, R.A., Soares Filho, B.S., Nepstad, D., 2004. A demographic dynamic systems for the Brazilian Amazon's municipalities. In: III Conferencia Cientifica do LBA: Experimento de Grande Escala da Biosfera-Atmosfera na Amazonia, Brasilia, DF, Brasil.
- Gardner, R., 1982. Robust analysis of aggregation error. *Ecology*, 1771-1779.
- Gardner, R., 1998. Pattern, Process, and the Analysis of Spatial Scales. In: Peterson, D. L. and Parker, V. T., editors (Eds.). *Ecological Scale: Theory and Applications*. Columbia University Press, New York, p. 17-34.

- Georgescu-Roegen, N., 1971. *The Entropy Law and the Economic Process*, 2nd edition. Harvard University Press, Cambridge, Massachusetts.
- Gerwing, J.J., 2002. Degradation of forests through logging and fire in the eastern Brazilian Amazon. *Forest Ecology and Management* 157, 131–141.
- Golley, F.B., 1983. Decomposition. In: Golley, F. B., (Ed.). (Eds.). *Ecosystems of the World 14A. Tropical Rain Forest Ecosystems: Structure and Function*. Elsevier Scientific Publishing Company, Amsterdam, Netherlands, p. 157-166.
- Gomes, G.V., Vergolino, J.R., 1997. Trinta e cinco anos de crescimento economico na Amazonia. *Texto para Discussao N. 533. IPEA.*, 1-144.
- Grace, J., Lloyd, J., McIntyre, J., Miranda, A.C., Meir, P., Miranda, H.S., Nobre, C., Moncrieff, J., Massheder, J., Malhi, Y., Wright, I., Gash, J., 1995. Carbon dioxide uptake by an undisturbed tropical rainforest in southwest Amazonia, 1992-1993. *Science* 270, 778-780.
- Grace, J., Malhi, Y., 2002. Carbon dioxide goes with the flow. *Nature* 416, 594.
- Gunderson, L.H., Holling, C.S., Pritchard Jr., L., Peterson, G.D., 2002. Resilience of Large-Scale Resource Systems. In: Gunderson, L. H. and Pritchard Jr., L., editors (Eds.). *Resilience and Behavior of Large-Scale Systems*. U.K. Island Press, Washington, DC, p. 3-20.
- Haefner, J.W., 1996. *Modeling Biological Systems: Principles and Applications*. Chapman and Hall, New York, NY, p. 473.
- Hahmann, A.N., Dickinson, R.E., 1997. RCCM2-BATS model over tropical South America: Applications to Tropical Deforestation. *Journal of Climate* 10, 1944-1964.
- Hall, A., 1986. More of the same in Brazilian Amazonia: A comment on Fearnside. *World Development* 14, 411-414.
- Hammond, D.S., ter Steege, H., 1998. Propensity for fire in Guianan rainforests. *Conservation Biology* 12, 944-947.
- Hardner, J.J., Frumhoff, P.C., Goetze, D., 2000. Prospects for mitigating carbon, conserving biodiversity, and promoting socioeconomic development objectives through the Clean Development Mechanism. *Mitigation and Adaptation Strategies for Global Change* 5, 61-80.
- Haridasan, M., 2001. Nutrient Cycling as a Function of Landscape and Biotic Characteristics in the Cerrados of Central Brazil. In: McClain, M. E., Victoria,

- R., and Richey, J. E., editors (Eds.). *The Biogeochemistry of the Amazon Basin*. Oxford University Press, New York, p. 68-83.
- Harris, D.R., 1980. Tropical Savanna Environments: Distribution, Diversity, and Development. In: Harris, D. R., (Ed.). (Eds.). *Human Ecology in Savanna Environments*. Academic Press, London, p. 2-27.
- Hecht, S., 1983. Cattle Ranching in the Eastern Amazon: Environmental and Social Implications. In: Moran, E. F., (Ed.). (Eds.). *The Dilemma of Amazonia Development*. Westview Press, Colorado, p. 155-188.
- Hecht, S., 1985. Environment, development and politics: Capital accumulation and livestock sector in Eastern Amazonia. *World Development* 13, 663-684.
- Hecht, S.B., 1993. The logic of livestock and deforestation in Amazonia: Considering land markets, value of ancillaries, the larger macroeconomic context, and individual economic strategies. *BioScience* 43, 687-695.
- Hecht, S.B., Norgaard, R.B., Possio, G., 1988. The economics of cattle ranching in eastern Amazonia. *Interciencia* 13, 233-240.
- Hedges, J.I., Clark, W.A., Quay, P.D., Richey, J.E., Devol, A.H., Santos, U.d.M., 1986a. Compositions and fluxes of particulate organic material in the Amazon River System. *Limnology and Oceanography* 31, 717-738.
- Hedges, J.I., Cowie, G.L., Richey, J.E., Quay, P.D., Benner, R., Strom, M., Forsberg, B.R., 1994. Origins and processing of organic matter in the Amazon River as indicated by carbohydrates and amino acids. *Limnology and Oceanography* 39, 743-761.
- Hedges, J.I., Ertel, J.R., Quay, P.D., Grootes, P.M., Richey, J.E., Devol, A.H., Farwell, G.W., Schmidt, F.W., Salati, E., 1986b. Organic Carbon-14 in the Amazon River System. *Science* 231, 1129-1131.
- Henderso-Sellers, A., Gornitz, V., 1984. Possible climatic impact of land cover transformations, with particular emphasis on tropical deforestation. *Climate Change*, 231-257.
- Henderson-Sellers, A., Dickinson, R.E., Durbidge, R.E., Kennedy, P.J., McGuffie, K.M., Pitman, J., 1993. Tropical deforestation: Modeling local- to regional-scale climate change. *Journal of Geophysical Research* 98, 7289-7315.
- Hendry, D.F., 1997. *Dynamic Econometrics: Advanced Texts in Econometrics*. Oxford University Press, New York, NY, p. 869.

- Herrera, R., Jordan, C.F., Klinge, H., Medina, E., 1978. Amazon ecosystems: Their structure and functioning with particular emphasis on nutrients. *Interciencia* 3, 223-231.
- Herrera, R., Jordan, C.F., Medina, E., Klinge, H., 1981. How human activities disturb the nutrient cycles of a tropical rainforest in Amazonia. *Ambio* 10, 109-114.
- Holdsworth, A.R., Uhl, C., 1997. Fire in Amazonian selectively logged rain forest and the potential for fire reduction. *Ecological Applications* 7, 713-725.
- Holling, C.S., 1994. New Science and New Investments for a Sustainable Biosphere. In: Jansson, A., Hammer, M., Folke, C., and Costanza, R., editors (Eds.). *Investing in Natural Capital: The Ecological Economics Approach to Sustainability*. Island Press, Washington, D.C., p. 57-73.
- Holling, C.S., 1996. The Resilience of Terrestrial Ecosystems: Local Surprise and Global Change. In: Clark, W. C. and Munn, R.E., editors (Eds.). *Sustainable Development of the Biosphere*. Cambridge University Press, Cambridge, p. 107-132.
- Holmes, T.P., Blate, G.M., Zweede, J.C., Pereira Jr., R., Barreto, P., Boltze, F., Bauch, R., 2002. Financial and ecological indicators of reduced impact logging performance in the eastern Amazon. *Forest Ecology and Management* 163, 93-110.
- Houghton, R.A., Hobbie, J.E., Melillo, J.M., Moore, B., Peterson, B.J., Shaver, G.R., Woodwell, G.M., 1983c. The future role of tropical forests in affecting the carbon dioxide concentration of the atmosphere. *Ambio* 19, 204-209.
- Houghton, R.A., Lefkowitz, D.S., Skole, D., 1983a. Changes in the landscape of Latin America between 1850 and 1985 I. Progressive loss of forests. *Forest Ecology and Management* 38, 143-172.
- Houghton, R.A., Skole, D., Lefkowitz, D.S., 1983b. Changes in the landscape of Latin America between 1850 and 1985 II. Net release of CO₂ to the atmosphere. *Forest Ecology and Management* 38, 173-199.
- Houghton, R.A., Skole, D.L., Nobre, C.A., Hackler, J.L., Lawrence, K.T., Chomentowski, W.H., 2000. Annual fluxes of carbon from deforestation and regrowth in the Brazilian Amazon. *Nature* 403, 301-304.
- Hughes, R.F., Kauffman, J.B., Jaramillo, V.J., 1999. Biomass, carbon, and nutrient dynamics of secondary forests in a humid tropical region of Mexico. *Ecology* 80, 1892-1907.

- Huston, M., DeAngelis, D., Post, W., 1988. New computer models unify ecological theory. *BioScience* 38, 682-691.
- IBGE, 1985. Censo Agropecuário 1975. Brazil. Instituto Brasileiro de Geografia e Estatística - IBGE, Rio de Janeiro, RJ, Brazil.
- IBGE, 1985. Censo Agropecuário 1985. Brazil. Instituto Brasileiro de Geografia e Estatística - IBGE, Rio de Janeiro, RJ, Brazil.
- IBGE, 1996. Censo Agropecuário 1995-1996. Brazil. N. 1. Electronic version downloaded on 10/25/02 from http://www2.ibge.gov.br/pub/Censos/Censo_Agropecuario_1995_96/. Instituto Brasileiro de Geografia e Estatística - IBGE, Rio de Janeiro, RJ, Brazil.
- IBGE, 1996. Anuario Estatístico do Brasil. Instituto Brasileiro de Geografia e Estatística - IBGE, Rio de Janeiro, Brasil.
- IBGE, 2000. Censo Demográfico 2000: Características Gerais da População/Resultados da Amostra. Instituto Brasileiro de Geografia e Estatística - IBGE, Rio de Janeiro, RJ, Brasil, p. 178.
- IBGE, 2002. Indicadores de Desenvolvimento Sustentável. Estudos e Pesquisas Informação Geográfica número 2. Instituto Brasileiro de Geografia e Estatística - IBGE, Rio de Janeiro, Brasil, p. 195.
- IBGE, 2003. Contas Nacionais. Volume 11. Contas Regionais do Brasil - 2001. IBGE, Rio de Janeiro, Brazil., p. 112.
- IBGE, 2004a. Sistema IBGE de Recuperação Automática SIDRA. Downloaded on 01/13/04 at <http://www.sidra.ibge.gov.br/bda/acervo/acervo2.asp?e=c&p=Pv&v=144&z=t&o=15> 2004.
- IBGE, 2004b. Contas Regionais. Tabela 2000.zip. Downloaded on 03/10/04 from http://www2.ibge.gov.br/pub/Contas_Regionais/
- INPE, 2002. Monitoring of the Brazilian Amazonian Forest by Satellite 2000-2001 - June 2002. http://www.inpe.br/Informacoes_Eventos/amz2000_2001/10/01/02
- INPE. 2004. Monitoramento da Floresta Amazônica Brasileira por Satellite: Projeto PRODES. Downloaded on 01/06/04 from <http://www.obt.inpe.br/prodes.html>.
- IPAM, 2003. Florestas tropicais e o Protocolo de Quioto: Uma nova perspectiva. *Clima em Revista: Informe sobre mudanças climáticas* 3.

- Järvelin, K., Wilson, T.D., 2003. On conceptual models for information seeking and retrieval research. *Information Research* 9, Retrieved on 30 December 2003 from <http://informationr.net/ir/2009-2001/paper2163.html#eng2062>
- Jones, D.W., Dale, V.H., Beauchamp, J.J., Pedlowski, M.A., O'Neill, R.V., 1995. Farming in Rondonia. *Resource and Energy Economics* 17, 155-188.
- Jordan, C.F., 1982. The nutrient balance of an Amazonian rain forest. *Ecology* 63, 647-654.
- Jordan, C.F., 1985. *Nutrient Cycling in Tropical Forest Ecosystems: Principles and their Application in Management and Conservation*. John Wiley & Sons Ltd., New York, NY., p. 190.
- Jordan, C.F., Herrera, R., 1981. Tropical rain forests: Are nutrients really critical? *The American Naturalist* 117, 167-180.
- Jordan, C.F., Heuveltop, J., 1981. The water budget of an Amazonian rain forest. *Acta Amazonica* 11, 87-92.
- Jordan, C.F., Kline, J.R., 1972. Mineral cycling: Some basic concepts and their application in a tropical forest, p. 33-50.
- Jordan, C.F., Kline, J.R., Sasscer, D.S., 1972. Relative stability of mineral cycles in forest ecosystems. *The American Naturalist* 106, 237-253.
- Jorgensen, S.E., 1986. *Fundamentals of Ecological Modelling*. Elsevier, Amsterdam, Netherlands, p. 389.
- Kaimowitz, D., Mertens, B., Wunder, S., Pacheco, P. 2004. A Conexao Hamburguer Alimenta a Destruição da Amazonia. Retrieved on 04/12/04 from http://www.Amazonia.org.br/guia/detalhes.cfm?id=103607&tipo=6&cat_id=44&subcat_id=185. Center for International Forestry Research, Bogor, Indonesia.
- Kainowitz, D., Angelsen, A., 1998. *Economic Models of Tropical Deforestation: A Review*. Center for International Forestry Research, Bogor, Indonesia, p. 139.
- Kauffman, J.B., 1991. Survival by sprouting following fire in tropical forests of the eastern Amazon. *Biotropica* 23, 219-224.
- Kauffman, J.B., Cummings, D.L., Ward, D.E., 1998. Fire in the Brazilian Amazon: 2. Biomass, nutrient pools, and losses in cattle pastures. *Oecologia* 113, 415-427.
- Kauffman, J.B., Cummings, D.L., Ward, D.E., Babbit, R., 1995. Fire in the Brazilian Amazon: 1. Biomass, nutrient pools, and losses in slashed primary forests. *Oecologia* 104, 397-408.

- Kauffman, J.B., Uhl, C., 1990. Interactions of anthropogenic activities, fire, and rain forest in the Amazon Basin. In: Billings, D., Golley, F., Lange, O. L., J. S. Olson, J. S., and Remmert, H., editors (Eds.). *Fire in the Tropical Biota. Ecosystems Processes and Global Challenges*. Springer-Verlag, New York, NY, p. 117-134.
- Keller, M., Jacob, D.J., Wofsy, S.C., Harriss, R.C., 1991. Effects of tropical deforestation and regional atmospheric chemistry. *Climatic Change* 19, Climatic Change 19: 139-158.
- Khanna, P.K., Snowdon, P., Bausch, J., 2000. Carbon Pools in Forest Ecosystems of Australasia and Oceania. In: Lal, R., Kimble, J. M., and Stewart, B. A., editors (Eds.). *Global Climate Change and Tropical Ecosystems*. CRC Press, Boca Raton, p. 51-70.
- Kinnaird, M.F., O'Brien, T.G., 1998. Ecological effects of wildfire on lowland rainforest in Sumatra. *Conservation Biology* 12, 954-956.
- Kira, T., Yoda, K., 1989. Vertical Stratification in Microclimate. In: Lieth, H. and Werger, M. J. A., editors (Eds.). *Ecosystems of the World : Tropical Rain Forest Ecosystems*, Amsterdam, Netherlands, p. 55-71.
- Kiss, A., Castro, G., Newcombe, K., 2002. The role of multilateral institutions. *Philosophical Transactions of the Royal Society of London Series A* 360, 1641-1652.
- Kleidon, A., Heimann, M., 1999. Deep-rooted vegetation, Amazon deforestation, and climate: Results from a modelling study. *Global Ecology and Biogeography* 8, 397-405.
- Klinge, H., 1973. Root mass estimation in lowland tropical rain forests of central Amazonia, Brazil. I. Fine root masses of a pale yellow latosol, and a giant humus podzol. *Tropical Ecology* 14, 29-38.
- Klinge, H., 1975. Root mass estimation in lowland tropical rain forests of central Amazonia, Brazil. III. Nutrients in fine roots from giant humus podsols. *Tropical Ecology* 16, 28-38.
- Klinge, H., 1976. Root mass estimation in lowland tropical rain forests of central Amazonia, Brazil. IV. Nutrients in fine roots from latosols. *Tropical Ecology* 17, 79-88.
- Kohlhepp, G., 2001. Amazonia 2000: An evaluation of three decades of regional planning and development programmes in the Brazilian Amazon. *Amazoniana* XVI (3/4), 363-395.

- Kormondy, E.J., 1984. Concepts of Ecology, 3rd edition. Prentice-Hall, Inc., Englewood Cliffs, N.J., p. 298.
- Kramer, R., Healy, R., Mendelsohn, R., 1992. Forest Valuation. In: Sharma, N. P., (Ed.). (Eds.). Managing the World's Forests: Looking for Balance Between Conservation and Development. Kendall/Hunt Publishing Company, Dubuque, Iowa, p. 237-267.
- Kreibich, H., Kern, J., 2003. Nitrogen fixation and denitrification in a floodplain forest near Manaus. *Hydrological Processes* 17, 1431-1441.
- Lambin, E.F., 1994. EUR 15744 - Modelling Deforestation Processes: A Review. European Commission: Office for Official Publications of the European Community, Brussels, Luxembourg, p. 128.
- Lambin, E.F., Erlich, D., 1997. The identification of tropical deforestation fronts at broad spatial scales. *International Journal of Remote Sensing* 18, 3551-3568.
- Lamotte, M., Bourliere, F., 1983. Energy Flow and Nutrient Cycling in Tropical Savannas. In: Bourliere, F., (Ed.). (Eds.). Tropical Savannas. Ecosystems of the World 13. Elsevier Scientific Publishing Company, Amsterdam. The Netherlands, p. 583-603.
- Langevin, M.S., Rosset, P., 1999. Land Reform from Below: The Landless Worker's Movement in Brazil. In: Boucher, D. M., (Ed.). (Eds.). The Paradox of Plenty: Hunger in a Bountiful World. Institute for Food and Development Policy, Oakland, CA, p. 323-328.
- Lauer, W., 1989. Climate and Weather. In: Lieth, H. and Werger, M. J. A., editors (Eds.). Ecosystems of the World : Tropical Rain Forest Ecosystems, Amsterdam, Netherlands, p. 7-54.
- Laurance, W.F., 1998. A crisis in the making: responses of Amazonian forest to land use and climate change. *TRENDS in Ecology & Evolution* 13, 411-415.
- Laurance, W.F., 2001. Tropical logging and human invasions. *Conservation Biology* 15, 4-5.
- Laurance, W.F., Cochrane, M.A., Bergen, S., Fearnside, P.M., Delamonica, P., Barber, C., D'Angelo, S., Fernandes, T., 2001. The future of the Brazilian Amazon. *Science* 15, 438-439.
- Laurance, W.F., Gascon, C., Merona, J.M.R.-d., 1999. Predicting effects of habitat destruction on planet communities: A test of a model using Amazonian trees. *Ecological Applications* 9, 548-554.

- Laurance, W.F., Laurance, S.G., Delamonica, P., 1998. Tropical forest fragmentation and greenhouse gas emissions. *Forest Ecology and Management* 110, 173-180.
- Laurance, W.F., Oliveira, A.A., Laurance, S.G., Condit, R., Nascimento, H.E.M., Sanchez-Thorin, A.C., Lovejoy, T.E., Andrade, A., D'Angelo, S., Ribeiro, J.E., Dick, C.W., 2004. Pervasive alteration of tree communities in undisturbed Amazonian forest. *Nature* 428, 171-175.
- Lavelle, P., Editor. 1987. *Biological Processes and Productivity of Soils in the Humid Tropics*. Wiley & Sons, New York, NY, p. 175-223.
- Lawn, P.A., 2001. *Toward Sustainable Development: An Ecological Economics Approach*. Lewis Publishers, Boca Raton, FL, p. 462.
- LBA, 1999. LBA estuda a biosfera e a atmosfera na Amazonia. *Folha Amazonica. Boletim do Experimento de Grande Escala da Biosfera-Atmosfera na Amazonia* 1, 1.
- LBA, 2001. Torres de medicoes de fluxo de gas carbonico no LBA. *Folha Amazonica. Boletim do Experimento de Grande Escala da Biosfera-Atmosfera na Amazonia* 3, 1.
- LBA, 2002b. Entendendo alguns aspectos das mudancas climaticas: O papel dos aerosols na formacao de nuvens. *Folha Amazonica. Boletim do Experimento de Grande Escala da Biosfera-Atmosfera na Amazonia* 4, 4.
- LBA, 2003a. O estoque de carbono das florestas maduras: Uma questao ainda em aberto. *Folha Amazonica. Boletim do Experimento de Grande Escala da Biosfera-Atmosfera na Amazonia* 5, 4.
- LBA, 2003b. Modelagem como ferramenta de integracao das pesquisas do LBA. *Folha Amazonica. Boletim do Experimento de Grande Escala da Biosfera-Atmosfera na Amazonia* 5, 4.
- Lean, J., Bunton, C.B., Nobre, C.A., Rowntree, P.R., 1996. The Simulated Impact of Amazonian Deforestation on Climate Using Measured ABRACOS Vegetation Characteristics. In: Gash, J., Nobre, c., Roberts, J., and Victoria, R., editors (Eds.). *Amazonia Deforestation and Climate*. John Wiley & Sons, New York, NY, p. 549-576.
- Lean, J., Rowntree, P.R., 1993. A GCM simulation of the impact of Amazonian deforestation on climate using an improved canopy representation. *Quarterly Journal Royal Metereological Society* 119, 509-530.

- Lean, J., Rowntree, P.R., 1997. Understanding the sensitivity of a GCM simulation of Amazonian deforestation to the specification of vegetation and soil characteristics. *Journal of Climate* 10, 1216-1235.
- Lean, J., Warrilow, D.A., 1989. Simulation of the regional climatic impact of Amazon deforestation. *Nature* 342, 411-413.
- Lecocq, F. 2003. State and Trends for the Carbon Market 2003. The World Bank Group, Washington, DC.
- Lentini, M., Verissimo, A., Sobral, L., 2003. Fatos Florestais da Amazonia 2003. IPAM, Belem, PA, p. 114.
- Leopoldo, P.R., Franken, W., Salati, E., 1982. Balanco Hidrico de pequena bacia hidrografica em floresta Amazonica de terra firme. *Acta Amazonica* 12, 333-337.
- Lesack, L.F.W., Melack, J.M., 1996. Mass balance of major solutes in a rainforest catchment in the Central Amazon: Implications for nutrient budgets in tropical rainforests. *Biogeochemistry* 32, 115-142.
- Levins, R., 1966. The strategy of model building in population biology. *American Scientist* 54, 421-431.
- Levins, R., 1993. A response to Orzack and Sober: Formal analysis and the fluidity of science. *The Quarterly Review of Biology* 68, 547-555.
- Levy, P.E., Cannell, M.G.R., Friend, A.D., 2004. Modelling the impact of future changes in climate, CO₂ concentration and land use on natural ecosystems and the terrestrial carbon sink. *Global Environmental Change* 14, 21-30.
- Lewis, W.M.J., Melack, J.M., McDowell, W.H., McLain, M., Richey, J.E., 1999. Nitrogen yields from undisturbed watersheds in the Americas. *Biogeochemistry* 46, 149-162.
- Lieth, H., 1975. Primary Production of the Major Vegetation Units of the World. In: Lieth, H. and Whittaker, R. H., editors (Eds.). *Primary Productivity of the Biosphere*. Springer-Verlag New York, Inc., New York, NY., p. 203-215.
- Likens, G.E., Bormann, E.H., 1999. *Biogeochemistry of a Forested Ecosystem*. Springer-Verlag New York Inc., New York, p. 159.
- Lillesand, T.M., Kiefer, R.W., 1994. *Remote Sensing and Image Interpretation*, 3rd. edition. John Wiley & Sons, Inc., New York, NY, p. 750.

- Long, S.P., Garcia Moya, E., Imbamba, S.K., Kamnalrut, A., Piedade, M.T.F., Scurlock, J.M.O., Shen, Y.K., Hall, D.O., 1989. Primary productivity of natural grass ecosystems of the tropics: A reappraisal. *Plant and Soil* 115, 155-166.
- Longman, K.A., Jenik, J., 1987. *Tropical forest and its environment*, 2nd edition. Longman Scientific and Technical. Copublished in the United States with John Wiley & Sons, Inc., New York, p. 347.
- Lu, D., Mausel, P., Brondizio, E., Moran, E., 2003. Classification of successional forest stages in the Brazilian Amazon basin. *Forest Ecology and Management* 181, 301-312.
- Ludwig, D., Hilborn, R., Walters, C., 1993. Uncertainty, resources exploitation, and conservation: Lessons from history. *Science* 260, 17.
- Luizao, F.J., 1989. Litter production and mineral element input to the forest floor in a central Amazonian Forest. *Geojournal* 19.4, 407-417.
- Luizao, R.C.C., Bonde, T.a., Rosswall, T., 1992. Seasonal variation of soil microbial biomass: The effects of clearfelling a tropical rainforest and establishment of pasture in the central Amazon. *Soil Biology and Biochemistry* 24, 805-813.
- Mahar, D., Schneider, R., 1994. Incentives for Tropical Deforestation: Some Examples from Latin America. In: Brown, K. and Pearce, D., editors (Eds.). *The Causes of Tropical Deforestation: The Economics and Statistical Analysis Giving Rise to the Loss of the Tropical Forests*. UBC Press., Vancouver, BC., p. 159-171.
- Malhi, Y., Baldocchi, D.B., Parvis, P.G., 1999. The carbon balance of tropical, temperate and boreal forests. *Plant, Cell and Environment* 22, 715-740.
- Malhi, Y., Grace, J., 2000. Tropical forests and atmospheric carbon dioxide. *TRENDS in Ecology & Evolution* 15, 332-337.
- Malhi, Y., Meir, P., Brown, S., 2002. Forests, carbon and global climate. *Philosophical Transactions of the Royal Society of London Series A* 360, 1567-1591.
- Margulis, S., 2003. *Causes of Deforestation of the Brazilian Amazon*. World Bank Working Paper no. 22, 1-77.
- Marques, J., Salati, E., dos Santos, J.M., 1980. Calculo da evapotranspiracao real na Bacia Amazonica atraves do metodo aerologico. *Acta Amazonica* 10, 357-361.
- Martinelli, L.A., Victoria, R.L., de Camargo, P.B., C., P.M.d., Mertes, L., Richey, J.E., Devol, A.H., Forsberg, B.R., 2003. Inland variability of carbon-nitrogen concentrations and $\delta^{13}C$ in Amazon floodplain (varzea) vegetation and sediment. *Hydrological Processes* 17, 1419-1430.

- Martinelli, L.A., Victoria, R.L., Devol, A.H., Richey, J.E., Forsberg, B.R., 1989. Suspended sediment load in the Amazon basin: An Overview. *Geojournal* 19.4, 381-389.
- Mattos, M.M., Uhl, C., 1994. Economic and ecological perspectives on ranching in the Easter Amazon. *World Development* 22, 145-158.
- Maxwell, T., Costanza, R., 1993. An approach to modelling the dynamics of evolutionary self-organization. *Ecological Modelling* 69, 149-161.
- McClain, M.E., 2001. The Relevance of Biogeochemistry to Amazon Development and Conversion. In: McClain, M. E., Victoria, R., and Richey, J. E., editors (Eds.). *The Biogeochemistry of the Amazon Basin*. Oxford University Press, New York, p. 3-16.
- McClain, M.E., Elsenbeer, H., 2001. Terrestrial Inputs to Amazon and Internal Biogeochemical Processing. In: McClain, M. E., Victoria, R., and Richey, J. E., editors (Eds.). *The Biogeochemistry of the Amazon Basin*. Oxford University Press, New York, p. 185-208.
- McGrath, D., Smith, C.K., Gholz, H.L., Oliveira, F.A., 2001. Effects of land-use change on soil nutrient dynamics in Amazonia. *Ecosystems* 4, 625-645.
- McGrath, D.A., Duryea, M.L., Comerford, N.B., Cropper, W., 2000. Nitrogen and phosphorous cycling in an Amazonian agroforest eight years following forest conversion. *Ecological Applications* 10, 1633-1647.
- McGuinnis, M.V., Woolley, J., Gamman, J., 1999. Bioregional conflict resolution: Rebuilding community in watershed planning and organizing. *Environmental Management* 24, 1-12.
- McKane, R.B., Rastetter, E.B., Melillo, J.M., Shaver, G.R., Hopkinson, S.S., Fernandes, D.N., Skole, D.L., Chomentowski, W.H., 1995. Effects of global change on carbon storage in tropical forests of South America. *Global Biogeochemical Cycle* 9, 329-350.
- Meade, R.H., Dunne, T., Richey, J.E., Santos, U.d.M., Salati, E., 1985. Storage and remobilization of suspended sediments in the lower Amazon River of Brazil. *Science* 228, 488-490.
- Medina, E., 1980. Ecology of Tropical American Savannas: An Ecophysiological Approach. In: Harris, D. R., (Ed.). (Eds.). *Human Ecology in Savanna Environments*. Academic Press, London, UK, p. 297-319.

- Melack, J.M., Forsberg, B.R., 2001. Biogeochemistry of Amazon Floodplain Lakes and Associated Wetlands. In: McClain, M. E., Victoria, R., and Richey, J. E., editors (Eds.). *The Biogeochemistry of the Amazon Basin*. Oxford University Press, New York, p. 235-274.
- Meybeck, M., 1982. Carbon, nitrogen, and phosphorous transport by world rivers. *American Journal of Science* 282, 401-450.
- Mittlemeier, R.A., 1988. Primate Diversity and the Tropical Forest: Case Studies from Brazil and Madagascar and the Importance of the Megadiversity Countries. In: Wilson, E. O. and Peter, F. M., editors (Eds.). *Biodiversity*. National Academy Press, Washington, D.C., p. 145-154.
- Montgomery, D.R., Grant, G.E., Sullivan, K., 1995. Watershed analysis as a framework for implementing ecosystem management. *Water Resources Bulletin* 31, 369-386.
- Montgomery, R.F., Askew, G.P., 1983. Soils of Tropical Savannas. In: Bourliere, F., (Ed.). (Eds.). *Tropical Savannas. Ecosystems of the World 13*. Elsevier Scientific Publishing Company, Amsterdam. The Netherlands, p. 63-78.
- Moraes, J.L., Cerri, C., Melillo, J.M., Kicklighter, D., Neill, C., Skole, D., Steudler, P.A., 1995. Soil carbon stocks of the Brazilian Amazon. *Soil Science Society of America Journal* 59, 244-247.
- Moraes, J.L., Volkoff, B., Cerri, C., Bernoux, M., 1996. Soil properties under Amazon forest and changes due to pasture installation in Rondonia, Brazil. *Geoderma* 70, 63-81.
- Moran, E.F., 1983. Growth Without Development: Past and Present Development Efforts in Amazonia. In: Moran, Emilio. F., (Ed.). (Eds.). *The Dilemma of Amazonian Development (Westview special studies on Latin America and the Caribbean)*. Westview Press, Inc., Boulder, Colorado, p. 3-23.
- Moran, E.F., 1991. Amazonian deforestation: Local causes and global consequences. In: Hansson, L. O. and Jungen, B., editors. *Human Responsibilities and Global Change: Proceedings from the International Conference in Goteborg 9-14 June, 1991*, University of Goteborg, Section of Human Ecology, p. 54-67.
- Moran, E.F., 1996. Deforestation in the Brazilian Amazon. In: Sponsel, L.E, Headland, T.M., and Bailey, R.C., editors (Eds.). *Tropical Deforestation: The Human Dimension*. Columbia University Press, New York, p. 149-164.
- Moran, E.F., Brondizio, E., Mausel, P., Wu, Y., 1994. Integrating Amazonian vegetation, land-use, and satellite data: Attention to differential patterns and rates of secondary succession can inform future policies. *BioScience* 44, 329-338.

- Moreira-Turcq, P., Seyler, P., Guyot, J.L., Etcheber, H., 2003. Exportation of organic carbon from the Amazon river and its main tributaries. *Hydrological Processes* 17, 1329-1344.
- Mortatti, J., Probst, J.-L., 2003. Silicate rock weathering and atmospheric/soil CO₂ uptake in the Amazon basin estimated from river water geochemistry: Seasonal and spatial variations. *Chemical Geology* 197, 177-196.
- Moutinho, P., 2004. Região amazônica almeja o desenvolvimento. *O Liberal*. Downloaded on 01/06/04 from http://www.Amazonia.org.br/opiniaio/artigo_detail.cfm?id=93362
- Mueller-Dombois, D., 1981. Fire in tropical ecosystems. In: Mooney, H. A., T. B.M. Bonnicksen, N. C. Christensen, J. E. Lotan, and W. A. Reiners, Technical Coordinators., editor. *Proceedings of the Conference on Fire Regimes and Ecosystems Properties*. United States Department of Agriculture Forest Service General Technical Report WO-26. United States Forest Service, Washington, DC.
- Mutch, R., 1970. Wildland fires and ecosystems – a hypothesis. *Ecology* 51, 1046-1051.
- Mylne, M.F., Rowntree, P.R., 1992. Effects of albedo change associated with tropical deforestation. *Climate Change* 21, 317-343.
- Nascimento, H.E.M., Laurance, W.F., 2002. Total aboveground biomass in central Amazonian rainforests: A landscape study. *Forest Ecology and Management* 168, 311-321.
- National Research Council. 1982. *Ecological Aspects of Development: Humid tropics*. National Academy of Science, Washington, DC., p. 40-50.
- NCEAS. 2004. Understanding, valuing, and managing dynamic ecosystem services under stress: Synthesizing across the LTER Network. <http://www.nceas.ucsb.edu/fmt/doc?https://www2.nceas.ucsb.edu/admin/db/web.plist>. In. NCEAS.
- Neill, C., Melillo, J.M., Steudler, P.A., Cerri, A.C., Moraes, J.F.L., Piccolo, M.C., Brito, M., 1997. Soil carbon and nitrogen stocks following forest clearing for pasture in the Southwestern Brazilian Amazon. *Ecological Applications* 7, 1216-1225.
- Nemani, R.R., Keeling, C.D., Hashimoto, H., Jolly, W.M., Piper, S.C., Tucker, C.J., Myneni, R.B., Running, S.W., 2003. Climate-driven increases in global terrestrial net primary production from 1982 to 1999. *Science* 300, 1560-1563.
- Nepstad, D., Carvalho, C.R.d., Davidson, E., Jipp, P.H., Paul A. Lafevbre, Gustavo H, N., Silva, E.D.d., Stone, T.A., Trumbore, S.A., Vieira, S., 1994. The role of deep

roots in the hydrological and carbon cycles of Amazonian forests and pastures. *Nature* 372, 666-669.

- Nepstad, D., Klink, C.A., Uhl, C., Vieira, I.C., Lefebvre, P., Pedlowski, M., Matricardi, E., Negreiros, G., Brown, I.F., Amaral, E., Homma, A., Walker, R., 1997. Land-use in Amazonia and cerrado of Brazil. *Ciencia e Cultura* 49 (1/2), 73-86.
- Nepstad, D., McGrath, D., Alencar, A., Barros, A.C., Carvalho, G., Santilli, M., Diaz, M.d.C., 2002. Frontier governance in Amazonia. *Science* 295, 629.
- Nepstad, D., Uhl, C., Serrao, E.A.S., 1991. Recuperation of a degraded Amazonian landscape: Forest recovery and agricultural restoration. *Ambio* 20, 248-255.
- Nepstad, D.C., Carvalho, G., Barros, A.C., Alencar, A., Copobianco, k.J.P., Bishop, J., Moutinho, P., Silva Jr, U.L., Prins, E., 2001. Road paving, fire regime feedbacks, and the future of Amazon forests. *Forest Ecology and Management* 154, 395-407.
- Nepstad, D.C., Moreira, A.G., Alencar, A., 1999a. Flames in the Rain Forest: Origins, Impacts and Alternatives to Amazonian Fire. The Pilot Program to conserve the Brazilian Rain Forest, Brasilia, Brazil. World Bank and Secretariat for the coordination of Amazon Affairs., p. 190.
- Nepstad, D.C., Moreira, A.G., Verissimo, A., C., P., Nobre, C., Setzer, A., Krug, T., Barrps, A.C., Alencar, A., Pereira., J.R., 1998. Forest fire prediction and prevention in the Brazilian Amazon. *Conservation Biology* 12, 951-953.
- Nepstad, D.C., Verissimo, A., Alencar, A., Nobre, C., Lima, E., Lefebvre, P., Schlesinger, P., Potter, C., Moutinho, P., Mendoza, E., Cochrane, M., Brooks, V., 1999b. Large-scale impoverishment of Amazonian forests by logging and fire. *Nature* 398, 505-508.
- Nicholson, W., 1998. *Microeconomic Theory: Basic Principles and Extensions*, 7th edition. The Dryden Press, Fort Worth, TX, p. 821.
- Nielsen, E., Frumhoff, P.C., Manion, M., Hardner, J.J., 2002. Designing a carbon market that protects forests in developing countries. *Philosophical Transactions of the Royal Society of London Series A* 360, 1875-1888.
- Niles, J.O., Brown, S., Pretty, J., Ball, A.S., Fay, J., 2002. Potential carbon mitigation and income in developing countries from changes in use and management of agricultural and forest lands. *Philosophical Transactions of the Royal Society of London Series A* 360, 1621-1639.
- Nix, H.A., 1983. Climate of Tropical Savannas. In: Bourliere, F., (Ed.). (Eds.). *Tropical Savannas. Ecosystems of the World* 13. Elsevier Scientific Publishing Company, Amsterdam. The Netherlands, p. 37-62.

- Noble, I.R., Dirzo, R., 1997. Forests as human-dominated ecosystems. *Science* 277, 522-525.
- Nobre, A.D., 2002. Afinal de contas, o bioma Amazonico e sumidouro ou e fonte de carbon para a atmosfera? *Folha Amazonica. Boletim do Experimento de Grande Escala da Biosfera-Atmosfera na Amazonia* 4, 1.
- Nobre, C.A., Nobre, A.D., 2002. O balanço do carbono da Amazônia Brasileira. In: Bosi, A. *Estudos Avançados* 16, 81-90.
- Nobre, C.A., Sellers, P.J., Shukla, J., 1991. Amazonia deforestation and regional climate change. *Journal of Climate* 4, 957-988.
- Norgaard, R.B., 1989. Three dilemmas of environmental accounting. *Ecological Economics* 1, 303-314.
- Nortcliff, S., Dias, A.C.D.C., 1988. The change in soil physical conditions resulting from forest clearance in the humid tropics. *Journal of Biogeography* 15, 61-66.
- Nye, P.H., Greenland, D.J., 1964. Changes in the soil after clearing tropical forest. *Plant and Soil* XXI, 101-112.
- Odum, E.P., 1992. Great ideas in ecology for the 1990. *BioScience* 42, 542-545.
- Odum, H.T., 1984. *Ecological and General Systems: An Introduction to Systems Ecology/Revised Edition*. University Press of Colorado, Niwot, Colorado, p. 644.
- Odum, H.T., 1996. *Environmental Accounting: Emergy and Environmental Decision Making*. John Wiley & Sons, Inc., New York, p. 370.
- Olson, J.S., 1963. Energy storage and the balance of producers and decomposers in ecological systems. *Ecology* 44, 322-331.
- Olson, J.S., Watts, J.A., Allison, L.J. 1983. Carbon in live vegetation of major world ecosystems. Rep. DOE/NBB-0037. U. S. Department of Energy Research, Carbon Dioxide Division, Washington, DC.
- Omernik, J.M., Bailey, R.G., 1997. Distinguishing between watersheds and ecoregions. *Journal of the American Water Resources Association* 33, 935-949.
- Oreskes, N., Shrader-Frechette, K., Belitz, K., 1994. Verification, validation, and confirmation of numerical models in the earth sciences. *Science* 263, 641-646.
- Orzack, S.H., Sober, E., 1993. A critical assessment of Levins's the strategy of model building in population biology. *The Quarterly Review of Biology* 68, 533-546.

- Owen, D.F., 1983. The Abundance and Biomass of Forest Animals. In: Golley, F. B., (Ed.). (Eds.). *Ecosystems of the World 14A. Tropical Rain Forest Ecosystems: Structure and Function*. Elsevier Scientific Publishing Company, Amsterdam, Netherlands, p. 93-100.
- Pagiola, S., Landell-Mills, Bishop, J., 2002. Market-Based Mechanisms for Forest Conservation and Development. In: Pagiola, S., Bishop, J., and Landell-Mills, editors (Eds.). *Selling Forest Environmental Services*. Earthscan Publications Ltd., Sterling, VA, p. 1-13.
- Pastor, J., Aber, J.D., McClaugherty, C.A., 1984. Aboveground production and N and P cycling along a nitrogen mineralization gradient on Blackhawk Island, Wisconsin. *Ecology* 65, 256-268.
- Peres, C.A., 2001. Paving the way to the future of Amazonia. *TRENDS in Ecology & Evolution* 16, 217-219.
- Perz, S.G., Skole, D.L., 2003. Social determinants of secondary forests in the Brazilian Amazon. *Social Science Research* 32, 25-60.
- Peterson, G., Allen, C.R., Holling, C.S., 1998. Ecological resilience, biodiversity, and scale. *Ecosystems* 1, 6-18.
- Peterson, G.D., Cumming, G.S., Carpenter, S.R., 2003. Scenario Planning: a Tool for Conservation in an Uncertain World. *Conservation Biology*. *Conservation Biology* 17, 358-366.
- Pfaff, A.S.P., 1999. What drives deforestation in the Brazilian Amazon? Evidence from satellite and socioeconomic data. *Journal of Environmental Economics and Management* 37, 26-43.
- Phillips, O.L., Malhi, Y., Higuchi, N., Laurance, W.F., Nunes, P.V., Vasquez, R.M., Laurance, S.G., Ferreira, L.V., Stern, M., Brown, S., Grace, J., 1998a. Changes in the carbon balance of tropical forests: Evidence from long-term plots. *Science* 282, 439-442.
- Phillips, O.L., Malhi, Y., Higuchi, N., Laurance, W.F., Nunes, P.V., Vasquez, R.M., Laurance, S.G., Ferreira, L.V., Stern, M., Brown, S., Grace, J., 1998b. Changes in the carbon balance of tropical forests: Evidence from long-term plots. Supplementaty material. Available online at (<http://www.sciencemag.org/feature/data/976299.shl>). *Science* 282, 439-442.
- Pires, J.M., 1978. The Forest Ecosystems of the Brazilian Amazon: Description, Functioning and Research Needs. In: *Tropical Forest Systems: A state-of-knowledge Report*. UNESCO, Paris, p. 607-627.

- Plotkin, M.J., 1988. The Outlook for New Agricultural and Industrial Products from the Tropics. In: Wilson, E. O. and Peter, F. M., editors (Eds.). Biodiversity. National Academy Press, Washington, D.C., p. 106116-106129.
- Polcher, J., Laval, K., 1994. The impact of African and Amazonian deforestation on tropical climate. *Journal of Hydrology* 155, 389-405.
- Portela, J.B., 2002. Personal communication. Average urban area (residential and public) per inhabitant in the Amazon region.
- Portela, R., Rademacher, I., 2001. A dynamic model of patterns of deforestation and their effect on the ability of the Brazilian Amazon to provide ecosystem services. *Ecological Modeling* 143, 115-146.
- Portes, A., 1998. Social capital: its origins and applications in modern sociology. *Annual Review of Sociology* 24, 1-24.
- Post, W.M., Pastor, J., Zinke, P.J., Stangenberger, A.G., 1985. Global patterns of soil nitrogen storage. *Nature* 317, 613-616.
- Potter, C., Davidson, E., Nepstad, D., de Carvalho, C.R., 2001. Ecosystem modeling and dynamic effects of deforestation on trace gas fluxes in Amazon tropical forests. *Forest Ecology and Management* 152, 97-117.
- Prentice, L.C., Lloidy, J., 1998. C-quest in the Amazon Basin. *Nature* 396, 619-620.
- Prugh, T., Editor. 1999. *Natural Capital and Human Economic Survival*, 2nd edition. Lewis Publishers, Boca Raton, FL, p. 180.
- Prugh, T., 1999. *Natural Capital and Human Economic Survival*. In: Costanza, R., (Ed.). (Eds.). *Ecological Economics*. Lewis Publishers, Boca Raton, FL, p. 180.
- Putnan, R.D., with Leonardi, R., and Nanetti, R.Y., 1993. *Making Democracy Work: Civic Traditions in Modern Italy*. Princeton University Press, Princeton, N.J., p. 258.
- Pyne, S.J., Andrews, P.L., Laven, R.D., 1996. *Introduction to Wildland Fire*. Wiley & Sons. Inc., New York, p. 769.
- Raich, J.W., Rastetter, E.B., Melillo, J.M., Kicklighter, D.W., Steudler, P.A., Peterson, B.J., Grace, A.L., Moore III, B., Vorosmarty, C.J., 1991. Potential net primary productivity in South America: Application of a global model. *Ecological Applications* 1, 399-429.
- Raich, J.W., Schlesinger, W.H., 1992. The global carbon dioxide flux in soil respiration and its relationship to vegetation and climate. *Tellus* 44B, 81-99.

- Randerson, J.T., Chapin III, E.S., Harden, J.W., Neff, J.C., Harmon, M.E., 2002. Net ecosystem production: A comprehensive measure of net carbon accumulation by ecosystems. *Ecological Applications* 12, 937-947.
- Rasmusson, E.M., Wallace, J.M., 1983. Meteorological aspects of the El Niño/Southern oscillation. *Science* 222: 222, 1195-1202.
- Rastetter, E.B., King, A.W., Cosby, B.J., Hornberger, G.M., O'Neill, R.V., Hobbie, J.E., 1992. Aggregating fine-scale ecological knowledge to model coarser-scale attributes of ecosystems. *Ecological Applications* 2, 55-70.
- Reckhow, K.H., Chapra, S.C., 1983. Confirmation of water quality models. *Ecological Modelling* 20, 113-133.
- Reiners, W.A., Bouwman, A.F., Parsons, W.F.J., Keller, M., 1994. Tropical rain forest conversion to pasture: changes in vegetation and soil properties. *Ecological Applications* 4, 363-377.
- Reis, E., Guzman, R., 1994. An Econometrics model of Amazon deforestation. In: Brown, K. and Pearce, D., editors (Eds.). *The Causes of Tropical Deforestation: The Economics and Statistical Analysis Giving Rise to the Loss of the Tropical Forests*. UBC Press., Vancouver, BC., p. 172-191.
- Rice, R., 2003. Conservation Concessions - Concept Description. In: Vth World Parks Congress: Sustainable Finance Stream. Applications Session. Learning from concrete successes of sustainably financing protected areas. Workshop 9. Conservation Incentive Agreements., Durban, South Africa
- Richards, M., 2000. Can sustainable tropical forest be made profitable? The potential and limitations of innovative incentive mechanisms. *World Development* 28, 1001-1016.
- Richey, J.E., 1983. Interactions of C, N, P and S in River Systems: A Biogeochemical Model. In: Bolin, B. and Cook, R. B., editors (Eds.). *The Major Biogeochemical Cycles and Their Interactions*. John Wiley & Sons, New York, p. 365-383.
- Richey, J.E., Adams, J.b., Victoria, R.L., 1990. Synoptic-scale Hydrological and Biogeochemical Cycles in the Amazon River Basin: A Modeling and Remote Sensing Perspective. In: Hobbs, R. J. and Mooney, H. A., editors (Eds.). *Remote Sensing of Biosphere Functioning*. Springer-Verlag, New York, p. 249-268.
- Richey, J.E., Brock, J.T., Naiman, R.J., Wissmar, R.C., Stallard, R.F., 1980. Organic Carbon: Oxidation and Transport in the Amazon River. *Science* 207, 1348-1351.

- Richey, J.E., Devol, A.H., Wofsy, S.C., Victoria, R., Riberio, M.N.G., 1988. Biogenic gases and the oxidation and reduction of carbon in Amazon River and floodplain waters. *Limnology and Oceanography* 33, 551-561.
- Richey, J.E., Hedges, J.I., Devol, A.H., Quay, P.D., Victoria, R., Martinelli, L.A., Forsberg, B.R., 1990. Biogeochemistry of carbon in the Amazon River. *Limnology and Oceanography* 35, 352-371.
- Richey, J.E., Meade, R.H., Salati, E., Devol, A.H., Nordin, C.F., Jr., dos Santos, H., 1986. Water discharge and suspended sediments in the Amazon River 1982-1984. *Water Resources Research* 22, 756-764.
- Richey, J.E., Mellack, J.M., Aufdenkampe, A.K., Ballester, V.M., Hess, L.L., 2002. Outgassing from Amazonian rivers and wetlands as a large tropical source of atmospheric CO₂. *Nature* 416, 617-620.
- Richey, J.E., Mertes, L.A.K., Dunne, T., Victoria, R.L., Forsberg, B.R., Tancredi, A.C.N.S., Oliveira, E., 1989. Sources and routing of the Amazon River Flood Wave. *Global Biogeochemical Cycle* 3, 191-204.
- Richey, J.E., Salati, E., Victoria, R.L., Martinelli, L.A., 1995. Tropical Water Resource Management: The Biophysical Basis. In: Munasinghe, M. and Shearer, W., editors (Eds.). *Defining and Measuring Sustainability*. The International Bank for Reconstruction and Development/The World Bank, Washington, DC., p. 407-428.
- Richey, J.E., Victoria, R., Salati, E., Forsberg, B.R., 1991. The Biogeochemistry of a Major River System: The Amazon Case Study. In: Degens, E. T., Kempe, S., and Richey, J. E., editors (Eds.). *Biogeochemistry of Major World Rivers*. John Wiley & Sons Ltd., p. 57-74.
- Roberts, G.C., Andreae, M.O., Zhou, J., Artaxo, P., 2001. Cloud condensation nuclei in the Amazon Basin: "Marine" conditions over a continent? *Geophysical Research Letters* 28, 2807-2810.
- Robertson, G.P., 1989. Nitrification and Denitrification in Humid Tropical Ecosystems: Potential Controls on Nitrogen Retention. In: Proctor, J. (Ed.). *Mineral Nutrients in Tropical Forest and Savanna Ecosystems*. Special Publication N. 9 of the British Ecological Society. Blackwell Scientific Publications, p. 55-69.
- Robertson, G.P., Rosswall, T., 1986. Nitrogen in West Africa: The Regional Cycle. *Ecological Monographs* 56, 43-72.
- Rohter, L., 2003. Deep in the Amazon forest, vast questions about global climate change. *The New York Times* 11/04/2003.

- Roulet, M., Lucotte, M., Canuel, R., Farella, N., Courcelles, M., Guimaraes, J.-R.D., Mergeler, D., Amorim, M., 2000. Increase in mercury contamination recorded in lacustrine sediments following deforestation in central Amazon. *Chemical Geology* 165, 243-266.
- Roulet, M., Lucotte, M., Canuel, R., Farella, N., Goch, Y.G.d.F., Peleja, J.R.P., Guimaraes, J.-R.D., Mergler, D., Amorim, M., 2001. Spatio-temporal geochemistry of mercury in waters of the Tapajos and Amazon rivers, Brazil. *Limnology and Oceanography* 46, 1141-1157.
- Roulet, M., Lucotte, M., Saint-Aubun, A., Tran, S., Rheault, I., Farella, N., da Dilva, E.d.J., Dezencourt, J., Passos, C.-J.S., Soares, G.S., Guimaraes, J.-R.D., Mergeler, D., Amorim, M., 1998. The geochemistry of mercury in central Amazonian soils developed on the Alter-do-Chao formation of the lower Tapajos River Valley, Para state, Brazil. *The Science of the Total Environment* 223, 1-24.
- Rykiel, E.J.J., 1996. Testing ecological models: The meaning of validation. *Ecological Modelling* 90, 229-244.
- Salati, E., 1987. The Forest and the Hydrological Cycle. In: Dickinson, R. E., (Ed.). (Eds.). *The Geophisiology of Amazonia: Vegetation and Climate Interactions*. Wiley & Sons, New York, NY, p. 273-296.
- Salati, E., Dall'Olio, A., Matsui, E., Gat, J.R., 1979. Recycling of water in the Amazon Basin: An Isotopic Study. *Water Resources Research* 15, 1250-1258.
- Salati, E., Marques, J., 1984. Climatology of the Amazon Region. In: Sioli, H., (Ed.). (Eds.). *The Amazon: Limnology and Landscape Ecology of a Mighty Tropical River and its Basin*. Dr. W. Junk Publishers, Dordrecht, The Netherlands, p. 85-126.
- Salati, E., Nobre, C.A., 1991. Possible climatic impacts of tropical deforestation. *Climatic Change* 19, 177-196.
- Salati, E., Sylvester-Bradley, R., Victoria, R.L., 1982. Regional gains and losses of nitrogen in the Amazon basin. *Plant and Soil* 67, 367-376.
- Salati, E., Vose, P.B., 1984. Amazon Basin: A system in equilibrium. *Science* 225, 129-138.
- Saldarriaga, J.G., West, D.C., Tharp, M.L., Uhl, C., 1988. Long-term chronosequence of forest succession in the upper Rio Negro of Colombia and Venezuela. *Journal of Ecology* 76, 938-958.
- Saleska, S.R., Miller, S.D., Matross, D.M., Goulden, M.L., Wofsy, S.C., da Rocha, H.R., de Camargo, P.B., Crill, P., Daube, B.C., de Freitas, H.C., Hutyrá, L., Keller, M.,

- Kirchhoff, V., Menton, M., Munger, J.W., Pyle, E.H., Rice, A.H., Silva, H., 2003. Carbon in Amazon Forests: Unexpected seasonal fluxes and disturbance-induced losses. *Science* 302, 1554-1557.
- Salimon, C.I., Brown, I.F., 2000. Secondary forests in Western Amazonia: Significant sinks for carbon released from deforestation? *Interciencia* 25, 4.
- Salomão, R., Nepstad, D., Vieira, I.C., 1996. Como a biomassa de florestas tropicais influi no efeito estufa. *Ciencia Hoje* 21, 38-47.
- Sanchez, P.A., 1989. Soils. In: Lieth, H. and Werger, M. J. A., editors (Eds.). *Ecosystems of the World : Tropical Rain Forest Ecosystems*, Amsterdam, Netherlands, p. 73-88.
- Santilli, M., Moutinho, P., Schwartzman, S., Nepstad, D., Curran, L., Nobres, C., 2003. Tropical deforestation and the Kyoto Protocol: A new proposal. COP-9, 1st - 12th December, 2003. Downloaded on 01/06/04 from <http://www.ipam.org.br/eventos/cop9/>.
- Santos, O.M., Crisi, B.M., 1981. Efeito do desmatamento na atividade dos microorganismos de solo de terra firme na Amazonia. *Acta Amazonica* 11, 97-102.
- Sarmiento, G., 1983. The Savannas of Tropical America. In: Bourliere, F., (Ed.). (Eds.). *Tropical Savannas. Ecosystems of the World 13*. Elsevier Scientific Publishing Company, Amsterdam. The Netherlands, p. 245-288.
- Scatena, F.N., Walker, R.T., Homma, A.K.O., de Conto, A.J., Ferreira, C.A.P., Carvalho, R.d.A., da Rocha, A.C.P.N., dos Santos, A.I.M., de Olivera, P.M., 1996. Cropping and fallowing sequences of small farms in the "terra firme" landscape of the Brazilian Amazon: A case study from Santarem, Para. *Ecological Economics* 18, 29-40.
- Scherr, S.J., 1995. Economic factors in farmer adoption of agroforestry: Patterns observed in Western Kenya. *World Development* 23, 787-804.
- Schlesinger, W.H., 1997. *Biogeochemistry: An Analysis of Global Change*. Academic Press Limited, San Diego, CA, p. 588.
- Schmink, M., 1987. The rationality of tropical forest destruction. In: *Management of the Forest of Tropical America*. USDA Forest Service. pp. 11-30.
- Schroeder, P.E., Winjum, J.K., 1995a. Assessing Brazil's carbon budget: I. Biotic carbon pools. *Forest Ecology and Management* 75, 77-86.

- Schroeder, P.E., Winjum, J.K., 1995b. Assessing Brazil's carbon budget: II. Biotic fluxes and net carbon balance. *Forest Ecology and Management* 75, 87-99.
- Schwartz, C., 2000. Ate onde a Amazonia pode resistir? *Veja*, 68-72.
- Segura, O., Boyce, J.K., 1994. Investing in Natural and Human Capital in Developing Countries. In: Jansson, A., Hammer, M., Folke, C., and Costanza, R., editors (Eds.). *Investing in Natural Capital: The Ecological Economics Approach to Sustainability*. Island Press, Washington, DC, p. 479-489.
- Seiler, W., Crutzen, P.J., 1980. Estimates of gross and net fluxes of carbon between the biosphere and the atmosphere from biomass burning. *Climatic Change* 2, 207-247.
- Serrao, E.A.S., Homma, A.K.O., 1993. Brazil. In: National Research Council. *Sustainable Agriculture in the Humid Tropics*. National Academic Press, Washington DC., p. 265-351.
- Serrao, E.A.S., Nepstad, D., Walker, R., 1996. Upland agricultural and forestry development in the Amazon: Sustainability, criticality and resilience. *Ecological Economics* 18, 3-13.
- Setzer, A.W., Pereira, M.C., 1991. Amazonia biomass burnings in 1987 and an estimate of their tropospheric emissions. *Ambio* 20, 19-22.
- Sharp, D.D., Lieth, H., Whigham, D., 1975. Assessment of Regional Productivity in North Carolina. In: Lieth, H. and Whittaker, R. H., editors (Eds.). *Primary Productivity of the Biosphere*. Springer-Verlag New York Inc., New York, NY., p. 131-146.
- Shukla, J., Nobre, C.A., Sellers, P., 1990. Amazon deforestation and climate change. *Science* 247, 1322-1325.
- Skole, D., Tucker, C., 1993. Tropical deforestation and habitat fragmentation in the Amazon: Satellite data from 1978 to 1988. *Science* 260, 1905-1910.
- Skole, D.L., Chomentowski, W.H., Salas, W.A., Nobre, A.D., 1994. Physical and human dimensions of deforestation in Amazonia: In the Brazilian Amazon, regional trends are influenced by large-scale external forces but mediated by local conditions. *BioScience* 44, 314-322.
- Slocumbe, D.S., 1993a. Implementing ecosystem-based management. *BioScience* 43, 612-622.

- Slocombe, D.S., 1993b. Environmental planning, ecosystem science, and ecosystem approaches for integrating environment and development. *Environmental Management* 17, 289-303.
- Smeraldi, R., Carvalho, R., 2003. A Amazonia e o novo PPA: Como aprender com as lições do Avanço Brasil. Debate sobre Políticas Públicas para Amazônia na Imprensa Brasileira XIX.
- Smith, J., 2002. Afforestation and reforestation in the clean development mechanism of the Kyoto Protocol: Implications for forests and forest people. *International Journal of Global Environmental Issues* 2, 322-343.
- Smith, N.J.H., Serrao, E.A.S., Alvim, P.d.T., Falesi, I.C., 1995. Amazonia: Resiliency and Dynamism of the Land and Its People. United Nations University Press, Tokyo, p. 253.
- Snowling, S.D., Kramer, J.R., 2001. Evaluating modelling uncertainty for model selection. *Ecological Modelling* 138, 17-30.
- Solbrig, O.T., 1996. The Diversity of the Savanna Ecosystem. In: Solbrig, O. T., Medina, E., and Silva, editors (Eds.). *Ecological Studies. Vol 121. Biodiversity and Savanna Ecosystem Processes*. Springer-Verlag, Berlin Heidelberg, p. 1-26.
- Sombroek, W.G., Nachtergaele, F.O., Hebel, A., 1993. Amounts, dynamics and sequestering of carbon in tropical and subtropical soils. *Ambio* 22, 417-426.
- Sponsel, L.E., Bailey, R.C., Headland, T.N., 1996. Anthropological perspectives on the causes, consequences, and solutions of deforestation. In: Sponsel, L. E., Headland, T. N. , and Bailey, R. C., editors (Eds.). *Tropical Deforestation: The human dimension*. Columbia University Press,, New york, NY, p. 3-37.
- Stark, N., Spratt, M., 1977. Root biomass and nutrient storage in rain forest oxisols near San Carlos de Rio Negro. *Tropical Ecology* 18, 1-9.
- Stark, N.M., 1971a. Nutrient cycling: I. Nutrient distribution in some Amazonian soils. *Tropical Ecology* 12, 24-50.
- Stark, N.M., 1971b. Nutrient cycling II: Nutrient distribution in Amazonian vegetation. *Tropical Ecology* 12, 177-201.
- Stark, N.M., Jordan, C.F., 1978. Nutrient retention by the root mat of an Amazonian rain forest. *Ecology* 59, 434-437.
- Sud, Y.C., Sellers, P.J., Mintz, Y., Chou, M.D., Walker, G.K., Smith, W.E., 1990. Influence of the biosphere on the global circulation and hydrologic cycle: A GCM simulation experiment. *Agricultural and Forest Meteorology* 52, 133-180.

- Sud, Y.C., Yang, R., Walker, G.K., 1996. Tropical deforestation: Modeling local- to regional-scale climate change. *Journal of Geophysical Research* 101, 7095-7109.
- Sud, Y.C., Yang, R., Walker, G.K., 1996. Impact of in situ deforestation in Amazonia on the regional climate: General circulation model simulation study. *Journal of Geophysical Research* 101, 7095-7109.
- Swartzman, G.L., Kaluzny, S.P., 1987. Simulation Model Evaluation. In: *Ecological Simulation Primer*. University of California, Berkeley, Berkeley, CA., p. 209-250.
- Thomas, C.D., Cameron, A., Green, R.E., Bakkenes, M., Beaumont, L.J., Collingham, Y.C., Erasmus, B.F.N., de Siqueira, M.F., Grainger, A., Hannah, L., Hughes, L., Huntley, B., van Jaarsveld, A.S., Midgley, G.F., Miles, L., Ortega-Huerta, M.A., Peterson, A.T., Phillips, O.L., Williams, S.E., 2004. Extinction risk from climate change. *Nature* 427, 145-148.
- Tian, H., Melillo, J.M., Kicklighter, D.W., McGuire, A.D., Helfrich III, J.V.K., More, III, B., Vorosmarty, C.J., 1998. Effect of interannual climate variability on carbon storage in Amazonian ecosystems. *Nature* 396, 664-667.
- Tian, H., Melillo, J.M., Kicklighter, D.W., McGuire, A.D., More, III, B., Vorosmarty, C.J., 1999. Tian et al. Reply. *Nature* 399, 536.
- Tiessen, H., Chacon, P., Cuevas, E., 1994. Phosphorous and nitrogen status in soils and vegetation along a toposequence of dystrophic rainforests on the upper Rio Negro. *Oecologia* 99, 145-150.
- Toniolo, A., Uhl, C., 1995. Economic and ecological perspectives on agriculture in the Easter Amazon. *World Development* 23, 959-973.
- Uhl, C., 1982. Recovery following disturbances of different intensities in the Amazon Rain Forest of Venezuela. *Interciencia* 7, 19-24.
- Uhl, C., 1998. Perspectives on wildfire in the humid tropics. *Conservation Biology* 12, 942-943.
- Uhl, C., Buschbacher, R., 1985. A disturbing synergism between cattle ranch burning practices and selective tree harvesting in the eastern Amazon. *Biotropica* 17, 265-268.
- Uhl, C., Buschbacher, R., Serrao, E.A.S., 1988. Abandoned pastures in eastern Amazonia. I. Patterns of plant succession. *Journal of Ecology* 76, 663-681.

- Uhl, C., Jordan, C., Clark, K., Clark, H., Herrera, R., 1982. Ecosystem recovery in Amazon caatinga forest after cutting, shifting and burning, and bulldozer clearing treatments. *Oikos* 38, 313-320.
- Uhl, C., Kauffman, J.B., 1990. Deforestation, fire susceptibility, and potential tree responses to fire in the Eastern Amazon. *Ecology* 71, 437-449.
- UNFCCC. 1997. Kyoto Protocol to the United Nations Framework Convention on Climate Change (UNFCCC). Text available at <http://unfccc.int/>
- van der Werf, G., Randerson, J.T., Collatz, G.J., Giglio, L., Kasibhatla, P.S., Arellano Jr., A.F., Olsen, S.C., Kasischke, E.S., 2004. Continental-scale partitioning of fire emissions during the 1997 to 2001 El Niño/La Niña period. *Science* 303, 73-76.
- Van Winkle, W., Dale, V.H., 1998. Model Interactions: A reply to Aber. *ESA* 79, 257-259.
- Veja, 1999. Carrascos da Mata: O IBAMA identifica os dez maiores desmatadores da Amazonia, lideres de um processo que, em trinta anos, devastou na regioa uma ara de floresta equivalente a da Franca. *Veja* Apri/25/1999, 108-115.
- Verissimo, A., Barreto, P., Mattos, M., Tarifa, R., Uhl, C., 1992. Logging impacts and prospects for sustainable forest management in an old Amazonian frontier; the case of Paragominas. *Forest Ecology and Management* 55, 169-199.
- Villa Nova, N.A., Salati, E., Matsui, E., 1976. Estimativa de evapotranspiracao na Bacia Amazonica. *Acta Amazonica*.
- Vitousek, P.M., 1982. Nutrient cycling and nutrient use efficiency. *The American Naturalist* 119, 559-572.
- Vitousek, P.M., 1984. Litterfall, nutrient cycling, and nutrient limitation in tropical forests. *Ecology* 65, 285-298.
- Vitousek, P.M., Aber, J.D., Howarth, R.H., Likens, G.E., Matson, P.A., Schindler, D.W., Schlesinger, W.H., Tilman, D.G., 1997. Human alteration of the global nitrogen cycle: Sources and Consequences. *Ecological Applications* 7, 737-750.
- Vitousek, P.M., Howarth, R., 1991. Nitrogen limitation on land and in the sea: how can it occur? *Biogeochemistry* 13, 87-115.
- Vitousek, P.M., Matson, P.A., 1984. Mechanisms of nitrogen retention in forest ecosystems: A field experiment. *Nature* 225, 51-52.
- Vitousek, P.M., Reiners, W.A., 1975. Ecosystem succession and nutrient retention: A hypothesis. *BioScience* 25, 376-381.

- Vitousek, P.M., Sanford, J.R.L., 1986. Nutrient cycling in moist tropical forest. *Ann. Rev. Ecol. Syst.* 17, 137-167.
- Wagener, S.M., Oswood, M.W., Schimel, J.P., 1998. Rivers and soils: Parallels in carbon and nutrient processing. Stream and soil ecologists can learn much by understanding each other's perspective. *BioScience* 48, 104-108.
- Walker, G.K., Sud, Y.C., Atlas, R., 1995. Impact of the ongoing Amazonian deforestation on local precipitation: A GCM simulation model. *Bulletin of the American Meteorological Society* 76, 346-361.
- Walker, R., Moran, E., Anselin, L., 2000. Deforestation and cattle ranching in the Brazilian Amazon: External capital and household processes. *World Development* 28.
- Weber, D., 2003. Governo esboça plano para proteger Amazonia. Estado de Sao Paulo. Downloaded in 12/30/2003 from <http://www.estadao.com.br/ciencia/noticias/2003/dez/30/129.htm>
- Went, F.W., Stark, N., 1968. Mycorrhiza. *BioScience* 18, 1034-1039.
- Werner, P., 1984. Changes in soil properties during tropical wet forest succession in Costa Rica. *Biotropica* 16, 43-50.
- Werth, D., Avissar, R., 2002. The local and global effects of Amazon deforestation. *Journal of Geophysical Research - Atmospheres* 107, 55:51-58 (D50I: 10.1029/2002JD00717).
- Westervelt, J., 2001. Error and Uncertainty Analysis. In: *Simulation Modeling for Watershed Management*. Springer, New York, NY, p. 107-113.
- Whitmore, T.C., 1996. *An Introduction to Tropical Rain Forests*, 7 edition. Oxford University Press Inc., New York, p. 226.
- Whittaker, R.H., Marks, P.L., 1975. Methods of Assessing Terrestrial Productivity. In: Lieth, H. and Whittaker, R. H., editors (Eds.). *Primary Productivity of the Biosphere*. Springer-Verlag New York Inc., New York, NY., p. 55-118.
- Williams, M.R., Fisher, T.R., Melack, J.M., 1997. Solute dynamics in soil water and groundwater in a central Amazon catchment undergoing deforestation. *Biogeochemistry* 38, 303-335.
- Williams, M.R., Melack, J.M., 1997. Solute export from forested and partially deforested catchments in the central Amazon. *Biogeochemistry* 38, 67-102.

- Wissmar, R.C., Richey, J.E., Stallard, R.F., Edmond, J.M., 1981. Plantkon metabolism and carbon processes in the Amazon River, its tributaries, and floodplain waters, Peru-Brazil, May-June 1977. *Ecology* 62, 1622-1633.
- Wood, C.H., Perz, S.G., 1996. Population and Land-Use Changes in the Brazilian Amazon. In: Ramphal, S. and Sinding, S. W., editors (Eds.). *Population Growth and Environmen*. Praeger Publishers, Westport, CT.
- Wood, C.H., Skole, D., 1998. Linking satellite, census, and survey data to study deforestation in the Brazilian Amazon. In: Liverman, D. J., Moran, E. F., Rindifuss, R. R., and Stern, P. C., editors (Eds.). *People and Pixels: Linking Remote Sensing to Social Science*. National Academy Press, Washington DC, p. 70-93.
- Zeng, N., Dickinson, R.E., Zeng, X., 1996. Climatic impact of Amazon deforestation_ A mechanistic model study. *Journal of Climate* 9, 859-883.
- Zhang, H., Henderso-Sellers, A., McGufie, K., 1996a. Impacts of tropical deforestation. Part I: Process analysis of local climate change. *Climate Change* 9, 1497-1517.
- Zhang, H., McGufie, K., Henderso-Sellers, A., 1996b. Impacts of tropical deforestation. Part II: The role of large-scale dynamics. *Climate Change* 9, 2498-2521.

Rosimeiry Portela

1140 23rd ST. NW. Apt. 507
Washington DC 20037
rgportela@yahoo.com

202 833 9260 (H)

Career interest and expertise in market-based approaches to forest conservation and its continued provision of ecosystem services, with a special focus on climate regulation and biodiversity.

EDUCATION

University of Maryland

College Park, MD, USA

Marine Estuarine and Environmental Science Program (MEES) 08/1998 – 12/2004

Environmental Science/Ecological Economics program under Dr. Robert Costanza.

- Ph.D. awarded, 2004.
- Dissertation “Integrated Ecological Economic Modeling of Ecosystem Services from the Brazilian Amazon Rainforest”.
- Research focus: contribution of ecosystem services to the economy of the Brazilian Amazon and to the welfare of its population; assessment of the potential ecological economic impact of a forest-based climate mitigation project designed to curtail carbon emissions from deforestation and to provide an incentive to forest protection.
- Awarded MacArthur Foundation and Ford Foundation fellowships for three years of doctorate program.
- Awarded the LOICZ Project research assistantship and other research assistantships through the Institute for Ecological Economics/UMD for two remaining years of doctorate program.
- Co-founder of the ecological economic group student seminar; coordination, together with other student leaders, of group logistics as well as of schedule of presentations from a diverse range of speakers.

University of Florida

Gainesville, FL, USA

Department of Environmental Engineering

08/1996 – 12/1998

Systems Ecology and Emergy Analysis program under Dr. Mark Brown.

- M.E. awarded, 1998.
- Thesis “Emergy Evaluation of Large Scale Development Projects: Mato Grosso Natural Resource Management Project, a Case Study”.

- Research focus: cost benefit analysis of development and conservation projects.
- Awarded J. William Fulbright Scholarship for Master's program.

University of Mato Grosso **Cuiaba, MT, Brazil**
Department of Civil Engineering **03/1991 – 12/1992**

- Post-graduate Diploma in Safety Engineering awarded, 1993.

University of Mato Grosso **Cuiaba, MT, Brazil**
Department of Civil Engineering **03/1983 – 03/1988**

- B.Eng. awarded, 1988

EXPERIENCE

The World Bank Institute **Washington, DC, USA**
Consultant **09/2004 - Present**

- Assist the preparation and delivery of trainings on market-based mechanisms for forest conservation and sustainable use. Design and deliver presentations on ecosystem services and compensation mechanisms for their protection, with particular focus on the Brazilian Amazon.

The Institute for Ecological Economics_ IEE/UMD¹ **Washington, DC, USA**
Graduate Research Assistant: Dynamic systems modeler **08/1998 – 12/2004**

- Worked on team projects as well as independently on modeling projects investigating the provision of ecosystem goods and services and their contribution to human economy and welfare both on a global and regional scale.
- Author and co-author of papers and reports on modeling of ecosystem services.
- Presented research on ecosystem services at workshops and international conferences.
- Prepared and submitted numerous research grant proposals.

¹ Now University of Vermont Gund Institute for Ecological Economics_GIEE/UVM, Burlington, VT

**Fundação Estadual do Meio Ambiente/FEMA
State Foundation for the Environment**

**Cuiaba, MT, Brazil
08/2004**

Instructor: “Ecological Economics, Ecosystem Services, Carbon and Biodiversity Markets: Alternatives to Foster Conservation through Monetary Compensation”

- Prepared and taught a 40 hrs course to employees of the state environmental agency on microeconomics, environmental and ecological economics, climate change, market-based mechanisms to foster conservation and sustainable use of ecosystems with a focus on the carbon and biodiversity markets.

The Institute for Ecological Economics - IEE and Institute Pro-Natura Washington, DC,USA

02/2001-01/2002

Facilitator: Atelier workshop “Restoration of Brazil's Atlantic Forest as a Watershed Management Tool”

- Prepared the web site, selected applicants, developed schedule for presentations and activities, and provided overall coordination of a two-week problem-solving based workshop in the Atlantic forest region of Rio de Janeiro, Brazil.
 - Co-led a group that prepared a report on management guidelines and zoning plans for the effective implementation of local protected areas_ subsequently passed into law by the local legislature.

**Fundação Estadual do Meio Ambiente/FEMA
State Foundation for the Environment**

**Cuiaba, MT, Brazil
11/2002**

Instructor: “Introduction to Ecological Economics”

- Prepared and taught a 40 hrs course to employees of the state environmental agency on microeconomics, environmental economics, ecological economics, ecosystem services and environmental policy tools and management.

The World Bank

**Washington, DC, USA
05/1997-08/1997**

Intern: Assessment of natural resource management in selected World Bank Projects in Brazil

Prepared a comparative study on achievements/shortcomings of the Parana Land Management Project and Mato Grosso Natural Resource Management Project.

**Fundação Estadual do Meio Ambiente/FEMA
State Foundation for the Environment**

**Cuiaba, MT, Brazil
08/1996 – 04/2002**

Environmental Technology Analyst²: Carried out research projects associated with development and deforestation in the Amazon region.

² On leave of absence for graduate studies.

**Fundação Estadual do Meio Ambiente/FEMA
State Foundation for the Environment**

**Cuiaba, MT, Brazil
11/1994 – 07/1996**

Manager: Environmental Component of PRODEAGRO (World Bank Loan 3492-BR, US\$205 million total/US\$54.4 allocated in the environmental component).

- Coordinated the technical, physical and financial planning and implementation of projects in the fields of forest resources, mining activities, protected areas, environmental education, enforcement activities, environmental monitoring and remote sensing, and institutional strengthening. Provided strategies and mechanisms for the agency to better integrate the many environmental sub-components. Fostered communication and collaboration among the staff of the agency, as well as among those and other officials from state and federal organizations, NGOs, UNDP and the World Bank.

**Fundação Estadual do Meio Ambiente/FEMA
State Foundation for the Environment**

**Cuiaba, MT, Brazil
04/1994 – 11/1994**

Civil Engineer: Pantanal Ecology Project and the Pantanal/Everglades Exchange and Technical Training Program

- Coordinated the research cooperation projects between FEMA, the Federal University of Mato Grosso and the University of Florida.

**Compahia de Desenvolvimento do Estado de Mato Grosso
Mato Grosso State Development Company
Project Engineer:**

**Cuiaba, MT, Brazil
03/1988 – 04/1994**

- Elaborated and overlooked implementation of engineering projects.

CURRENT PROFESSIONAL AND PERSONNAL INTERESTS

- Market-based incentives to foster sustainable use and protection of forest ecosystems and its continued provision of ecosystem services.
- Climate protection initiatives that consider forest land-based opportunities for climate mitigation (e.g. avoided deforestation, protection of secondary and degraded land and sustainable management of forests among others).
- Compensation for the climate regulation service provided by forests in the form of carbon certificates (e.g. expansion of the scope of forest-based projects under the CDM mechanism of the Kyoto Protocol).
- Teaching of ecological economics principles: sustainable scale, just distribution and efficient allocation of resources, with a focus on practical applications of these principles.
- Fond appreciation of movies, Brazilian music, traveling, exotic and gourmet food, wine, hiking and spending time with family and friends.

FOREIGN LANGUAGE COMPETENCE

ENGLISH: Fluent

PORTUGUESE: Native Speaker

SPANISH/FRENCH/FINNISH: Limited reading and speaking ability

COMPUTER SKILLS

Mac OS 9.2 and OS X 10.3; Windows;

MS Office: Microsoft Word, Excel, Power Point, etc.;

ArcView; EndNote, SPSS, Entourage, Netscape, Explorer. Modeling Softwares: Q-Basic, Extend, Rule, Caps, Fragstats, Stella Programming Language.

PUBLICATIONS

Portela, R., Braga, R and Rodrigues, L. C. (in print) Ensuring Local Livelihood and Continued Provision of Environmental Services through the Implementation of Protected Areas. In Farley, J., Erickson, J. D. and Daly, H. Ecological Economics: Workbook. Island Press.

Wilson, M. A., Costanza, R., Boumans, R., Liu, S. and R. Portela. 2003. Valuing Ecosystem Goods and Services in the Coastal Zone. A Report to the Land-Ocean Interaction in the Coastal Zone (LOICZ) Project of the International Geosphere-Biosphere Programme.

Boumans, R., Costanza, R., Farley, J., Wilson, M. A., Portela, R., Villa, F., Rothmans, J. and Grasso, M. 2002. Modeling the dynamics and value of global ecosystem services. Ecological Economics 41: 529-560.

Portela, R. and I. Rademacher. 2001. A dynamic model of patterns of deforestation and their effect on the ability of the Brazilian Amazonia to provide ecosystem services. Ecological Modeling 143: 115 - 146.

REFERENCES

Gladly furnished upon request.