

ABSTRACT

Title of Dissertation: **(DIS)AGREE: MOVEMENT AND AGREEMENT RECONSIDERED**

Pritha Chandra, Ph.D., 2007

Directed By: **Professor Norbert Hornstein**
Department of Linguistics

This dissertation examines Agree, a narrow syntactic, long-distance operation underlying phi-agreement in the grammar. Taking the strong minimalist thesis (cf. Chomsky 2000) as my point of departure, I question Agree on both conceptual and empirical grounds. On the conceptual side, the operation is suspect first for its language-specific character. Second, it also fails to be justified on the grounds of general architectural constraints and legibility requirements. Further, evidences of various long-distance agreement from across languages examined here question the empirical basis for Agree built throughout the previous literature. As far as this is true, I contend that the faculty of language has nothing beyond Merge and Move/Internal Merge, the first being inevitable in any language-like system and the latter necessitated by interface exigencies. My purpose in this dissertation is to show that these two operations suffice to obtain phi-agreement in natural language.

(DIS)AGREE: AGREEMENT AND MOVEMENT RECONSIDERED

By

Pritha Chandra

**Dissertation submitted to the Faculty of the Graduate School of the
University of Maryland, College Park, in partial fulfillment
of the requirements for the degree of
Doctor of Philosophy
2007**

Advisory Committee:

**Professor Norbert Hornstein, Chair
Professor Howard Lasnik
Professor Juan Uriagereka
Dr. Cedric Boeckx, Harvard University
Professor John Caughey**

© Copyright by

Pritha Chandra

2007

ACKNOWLEDGEMENTS

Right from its conception to its realization, this thesis has benefited in immeasurable ways from interactions with Norbert Hornstein, Howard Lasnik, Juan Uriagereka and Cedric Boeckx. To each of them, I owe a great deal: Norbert for instilling in me faith for my own research, Howard for his masterful guidance through the technical thicket of linguistics, Juan for skillfully unfolding for me the complex contours of the linguistics system and Cedric for leading me to useful sources on agreement which I have pillaged to my advantage.

I am also very grateful to Prof. John Caughey for gracefully accepting the job of the dean's representative for my PhD defense.

Outside my committee, other faculty members in UMD have also contributed to my professional and personal growth as a linguist. To one of them, Paul Pietroski, I owe a particular debt. I had the privilege of having Paul not only supervise my minor (semantics) paper, but also instruct me in talking linguistics to a non-linguistics crowd. If not for him, I would never have received the Dean's Dissertation Fellowship in 2006, which gave me time off from teaching and allowed me to concentrate fully on my research.

I am also grateful to scholars from other universities who have helped me understand the phenomenon of agreement better and very often prevented me from making blunders. I

hope that those whom I forget to mention here will forgive me if I list those I have not: Rajesh Bhatt, Ivano Caponigro, Alice Davison, Anoop Mahajan, Alan Munn, Andrew Nevins, Maria Polinsky, K.V. Subbarao, and Heather Wilson. Others who have helped me with data from their languages include Tomohiro Fujii, Scott Fults, Prof. Omkar Koul, Shiti Malhotra, Sadaf Munshi, Chizuru Nakao and Acrisio Pires.

I also thank Kathi Faulkingham and Robert Magee for their relentless support and guidance through administrative intricacies during my stay in the US.

Above all, I would like to acknowledge those with whom I have shared the pains and pleasures of my graduate life, and who have helped me transcend the competitive strains of academia: Ilhan Cagri, Scott Fults, Soo-min Hong, Atakan Ince, Youngmi Jeong, Ivan Ortega-Santos, Dominik Rus, Asad Sayeed, Usama Soltan and Heather Taylor.

Finally, for years of companionship, for helping me never lose sight of my *daimon*, I am more than indebted to Pratyush. I also thank our parents for their emotional support throughout my (rather long) student life.

If despite enthusiasm, interest and help in my work from this long list of benefactors and friends, I have still got something wrong, then I, alone, am to blame.

TABLE OF CONTENTS

ACKNOWLEDGEMENTS	ii
TABLE OF CONTENTS	iv
CHAPTER 1 Agree: A Conceptual Reassessment	1
1.1 Minimalist Strivings	2
1.2 Merge, Move & Agree: Their Conceptual Loci	5
1.2.1 Merge: An Indispensable Operation	5
1.2.2 Move: From Imperfection to Virtual Conceptual Necessity	7
1.2.3 Agree: “An engineering solution”?	10
1.3 Phi-agreement and the sisterhood relation	20
1.4 The Empirical Support for Agree	24
1.5 Structure of the Dissertation	27
CHAPTER 2 On agreement across restructuring infinitivals	32
2.1 On Restructuring & Agreement	32
2.2 Hindi-Urdu Agreement	37
2.2.1 Cross-clausal agreement in Hindi-Urdu	43
2.3 Unpacking Previous Agree-based Accounts	47
2.3.1 Boeckx’s Multiple Agree Analysis	49
2.3.2 Bhatt’s AGREE system	54
2.3.3 Some general problems	64
2.4 Towards An Alternative	78
2.4.1 LDA with defective v	80
2.4.2 Predictions for Itelmen LDA	86
2.5 Chamorro LDA: A Brief Interlude	89
2.6 Remaining issues: Optional Agreement & Default Case	95
2.7 Whither Kashmiri?	101
2.8 Implications for Restructuring	106
2.9 Implications for QR	108
2.10 Conclusion	125
CHAPTER 3 Agreement across finite domains	126
3.1. Agreement, A-movement and Finiteness: Some initial remarks	127
3.2 Tsez: LDA and some other facts	135
3.3 The position of the agreement trigger	145
3.4 Previous Reflections: A Critique	148
3.4.1 The tale of the Agree-adherents	149
3.4.1.1 Polinsky and Potsdam (2001)	149
3.4.1.2 Bhatt (2005)	157
3.4.1.3. Boskovic (2005)	159

3.4.2 A specifier-head alternative	162
3.4.2.1 Koopman (2005)	162
3.4.2.2 Chandra (2006, 2007)	166
3.5 The multiple theta-case alternative	172
3.5.1 Intervention Effects or A over A violation?	183
3.6 Chukchee and Innu-aimûn LDA: A Problem?	187
3.7 Passamaquoddy LDA: Evidence or Counter-evidence?	197
3.8 Hungarian Focus-driven LDA: Twin Mechanisms	209
3.9 Basque LDA: A local Solution	214
3.10 Conclusion	226
 CHAPTER 4 Examining Defective Intervention Effects	 228
4.1 Defective Intervention: An Introduction	229
4.2 Problems with Defective Intervention	236
4.3 English Expletive-Associates: A Different Approach	247
4.4 Shortest Dependency: Measuring Syntactic Distance	254
4.5 Japanese Object Honorification	257
4.5.1 Boeckx and Niinuma (2003)	263
4.5.2 An Alternative Analysis	267
4.6 Icelandic Raising Constructions	277
4.6.1 Holmberg and Hroarsdottir (2003)	283
4.6.2 Boeckx (2003)	286
4.6.3 Some Problems	291
4.6.4 A Different Approach	294
4.7 Conclusion	311
 CHAPTER 5 Conclusion: The Way Forward	 312
5.1 Summary of the Results	312
5.2 Some Remaining Issues	316
5.2.1 Agreement Asymmetry	317
5.2.2 Surface Semantics	321
5.2.3 A Wh-in-situ Problem	324
 REFERENCES	 328

CHAPTER 1

AGREE: A CONCEPTUAL REASSESSMENT

This dissertation examines Agree, a narrow syntactic, long-distance operation underlying phi-agreement in the grammar. Taking the strong minimalist thesis (cf. Chomsky 2000, but also see Chomsky 2001a, b, 2005a,b, 2006) as my point of departure, I question Agree on both conceptual and empirical grounds. On the conceptual side, the operation is suspect first for its language-specific character. Second, it also fails to be justified on the grounds of general architectural constraints and legibility requirements. Further, evidences of various long-distance agreement from across languages examined here question the empirical basis for Agree. As far as this is true, I contend that the faculty of language has nothing beyond Merge and Move/Internal Merge, the first being inevitable in any language-like system and the latter necessitated by interface exigencies. My purpose in this dissertation is to show that these two operations suffice to obtain phi-agreement in natural language.

This chapter is devoted to reassessing the conceptualization of Agree within the minimalist paradigm. I initiate the discussion with a very brief overview of how minimalism assists in a better understanding of the language faculty (i) as located “within the array of cognitive systems of the mind/brain” and (ii) as embedded in the evolutionary process, conferring to “general considerations of conceptual naturalness” (Chomsky 1995:1). Assuming that language is an optimal solution to legibility conditions

and adopting as the research guideline that any property specific to language calls for a “principled explanation”, I set out to evaluate in the section 2 the justifications hitherto provided in the literature for postulating the three fundamental operations in the grammar: Merge, Move (a.k.a. Internal Merge) and Agree. This section reveals that unlike the former two, Agree is unique to the language faculty and also cannot be justified on general economy considerations. An even greater challenge for Agree comes from its dependence on c-command, itself not a primitive of the grammar. Section 3 includes a discussion on what counts as optimal configurations for phi-agreement. Following that in section 4, I present the empirical evidence that various researchers have previously adduced in its favor, the reanalysis of which constitute the agenda for the remaining chapters. Section 5 presents the road map of the dissertation.

1.1 Minimalist Strivings

In the trajectory of scientific development there are crucial moments or “extraordinary episodes” constituting decisive shifts in “professional commitments” triggering full-fledged scientific revolutions. Kuhn (1962) calls these episodes “the tradition-shattering complements to the tradition-bound activity of normal science.” The Principles and Parameters (P&P) approach can be rightly thought of bringing about one such epistemological rupture or paradigm shift within the generative tradition of linguistics.

In the era preceding this “radical departure”, the Faculty of language (FL) was construed with a rich and highly structured format. The "general theory of linguistic structures" (as in Chomsky 1957:50) was an arena of ever-increasing complex, language-specific and

construction-specific rules and principles. A common assumption underlying works of that era was that theory-formation required restricting the domain of admissible hypotheses, so that the language learner may hit upon the right theories corresponding to the input. That is to say that the range of competing grammars or ‘meta-languages’ tested against the evaluation procedure by the language-learner were extremely restricted, making it possible to answer ‘the logical problem of language acquisition’ with some success.

With the crystallization of the P&P approach, there was a drastic change in this scenario, with the principles of language now liberated from acquisition, itself reduced to the matter of parameter-setting (presumably, with binary values). FL was conceived as consisting of a restricted set of invariant principles and a few parameters, which accounted for both language variance and acquisition. There was no apparent necessity “to satisfy the empirical conditions of rapid convergence on generative systems of the kind required to determine meaning and external manifestation” (Chomsky 2006:2).

This relative autonomy of FL from its own empirical realization allows linguists to investigate it in its being or essence. This is a necessary step of abstraction, for until and unless a phenomenon is identified and given a proper shape with its own internal essence, it continues to be overwhelmed by the externalities and can only be deductively traced. On the contrary, by its identification (through the knowledge of its essence), we render possible the making of the “thing in itself” - paving the way for a more comprehensive analysis of the system, its interactions with other systems and finally its organization or

design in accordance with the general principles of nature. The same observations extend to the domain of FL, understood as a biological organ. With the P&P approach facilitating (these necessary and further) steps of abstraction, we can now conceptualize FL as embodying principles of growth and development typical to other cognitive domains of the mind/brain that also play a vital role in the evolutionary process. The focus of inquiry shifts from the nature of UG and linguistic experience to the “third factor” determinants in language design (Chomsky 2005a) - principles of structural architecture, constraints on the development and evolution of organic forms and computational efficiency. Notions like simplicity, economy, symmetry, non-redundancy are no longer merely methodological issues, but are directly derived from the workings of nature (also see Uriagereka 1998, 2002). The linguist’s job is to attempt to eliminate some of the language-specific technology (i.e. attribute less to the genetic endowment or UG) and, consequently, provide more “principled explanations”, i.e. provide answers that help reduce properties of language to properties of the interface systems and/or follow from general economy considerations.

The Minimalist Program helps us in formulating the right research questions in this regard. The substantive thesis of minimalism (or ‘ontological minimalism’, see Martin and Uriagereka 2001) is that language is an optimal solution to legibility or interface conditions (also dubbed as the Strong Minimalist Thesis/SMT). Language design is influenced by interface requirements, i.e. there is nothing in FL beyond what is required to produce optimal solutions for the interfaces in accordance to general principles of computational efficiency. The remaining task is then to attempt to validate this bold

conjecture by minimizing the differences that exist between FL and SMT. The lesser the difference between them, the less specific or unique becomes UG. “UG is what remains when the gap between SMT and the true nature of FL have been reduced to the minimum, when all third factor effects have been identified” (Chomsky 2006:3).

Taking the SMT as a point of departure, I venture to ask at this point, to what extent the core grammatical operations – Merge, Move and Agree – satisfy these conditions; i.e. whether or not they can be reduced to general architectural properties or they constitute part of the language-specific technology incorporated into the system to satisfy legibility conditions at the interfaces? In a nutshell, do we have a “principled explanation” for each of these operations?

1.2 Merge, Move & Agree: Their Conceptual Loci

1.2.1 Merge: An Indispensable Operation

In terms of “naturalness”, Merge stands out for being the least controversial among the set of operations. Note what Chomsky (2005a:11-12) has to say about it:

“An elementary fact about the language faculty is that it is a system of discrete infinity. Any such system is based on a primitive operation that takes n objects already constructed, and constructs from them a new object. Call that operation Merge. Either Merge or some equivalent is a minimal requirement... The simplest account of the “Great Leap Forward” in the evolution of humans would be that the brain was rewired perhaps

by some slight mutation, to provide the operation Merge, at once laying a core part of the basis for what is found at that dramatic “moment” of human evolution...”¹

To see the operation at work, consider (1):

(1)

$$\begin{array}{c} \gamma = \{\tau, \{\alpha, \beta\}\} \\ \swarrow \quad \searrow \\ \alpha \qquad \beta \end{array}$$

Merge takes two elements α and β to form a complex unit γ , with label τ projected from either of γ 's daughter-nodes. Recursive Merge allows larger units to be built from the previously constructed γ by concatenating more items to the structure. The newly constructed tree in (2) is labeled μ and is derived by merging an extra item μ with γ

(2)

$$\begin{array}{c} \mu = \{\mu, \{\tau, \{\alpha, \beta\}\}\} \\ \swarrow \quad \searrow \\ \mu \qquad \gamma = \{\tau, \{\alpha, \beta\}\} \\ \qquad \swarrow \quad \searrow \\ \qquad \alpha \qquad \beta \end{array}$$

Merge provides two relations for free: (i) ‘sisterhood’ between two items merged to each other and (ii) ‘immediately contain’ between the newly constructed structure and the most recent concatenates. Composition of relations gives us a larger set of relations. I take up this matter in more detail in section 3.

¹ To give an example of a symbolic system that uses concatenation, the language of propositional logic builds well-formed formulas by applying a fixed set of logical operators $\Omega = \{\text{not, and, or, conditional}\}$ on a finite set of terminal elements $A = \{p, q, r\}$.

In summary, Merge in natural language is not an anomaly or an imperfection; it is evident in all symbolic systems. We therefore have a “principled explanation” for positing it in the grammar.

1.2.2 Move: From Imperfection to Virtual Conceptual Necessity

There is a second operation in the grammar, Move, which displaces an element σ (or a copy of σ) within a phrase marker. Take (3) for illustration, where σ is shown to displace from its β -internal position to the specifier of γ .

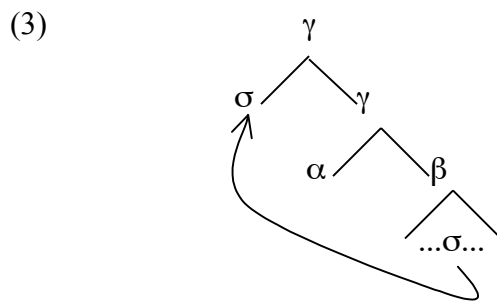

In the initial days of the minimalist program, movement or dislocation was considered an “imperfection”. The argument for this claim came from the fact that unlike Merge - this is a property very specific to language; it is never found as part of other symbolic systems. Chomsky (2000:120) seeks to justify its presence, along with that of the non-interpretable features (the driving force behind movement in the grammar) by suggesting that perhaps “they have to do with externally imposed legibility conditions” The Conceptual-Intentional systems require that outputs (SEM) to it from narrow syntax express interpretation roughly corresponding to (i) “deep” or theta-theoretic information and (ii)

“surface” or scope and discourse properties. The former is of the general type present in all language-like systems whereas the latter appears very specific to human language. This distinction, Chomsky claims, is marked by language in a systematic way – by including an operation like Move. Move or dislocation is incorporated into the language system with the objective of generating the second type of interpretation; namely “surface” or scope and discourse properties. It is therefore an anomaly but one that FL must possess in order to satisfy certain interpretative effects. As for the non-interpretable features, Chomsky conjectures that these too are only apparent imperfections as they are absolutely necessary to the system to be able to compute. Therefore, given the specific role of non-interpretable features in triggering dislocation in narrow syntax, it is conceivable that they are required by design specifications and therefore do not count as aberrations. Under this view, “the two imperfections might reduce to one, the dislocation property” (121).

Another problem noted with regard to Move was its (alleged) complex nature. It was assumed that the operation is a complex one composed of Merge and Agree (and delete). Good design conditions lead “us to expect that simpler operations are preferred to more complex ones, so that Merge or Agree (or their combination) preempt Move, which is a “last resort”, chosen when nothing else is possible” (Chomsky 2000:101-2). Under this approach, Move is a glitch that the grammar employs when derivational convergence is at stake.

More recently however, Chomsky has taken a radically different step by upgrading 'Move' to the status of a "virtual conceptual necessity" of the system. This idea is most clearly articulated in the following quote from Chomsky:

"Unless some stipulation is added, there are two sub-cases of the operation Merge. Given A, we can merge B to it from outside A or from within A; these are internal and external Merge, the latter [the sic] operation called "Move", which therefore also "comes free", yielding the familiar displacement property of language. That property had long been regarded, by me in particular, as an "imperfection" of language that has to be somehow explained, but in fact it is a virtual conceptual necessity; some version of transformational grammar seems to be the null hypothesis and any other mechanisms, beyond internal Merge, carry a burden of proof". (Chomsky 2005a:12-13)

This makes Move just another instance of Merge. It operates on items that are already part of a given phrase marker unlike Merge or External Merge that adds new items to it. In Chomsky's view, Move or Internal Merge yields different interpretive effects than External Merge; it serves topic/focus and discourse related properties at the C-I interface and can never target theta-domains, i.e. movement within a phrase-marker cannot be triggered for theta-theoretic reasons.² However, the jury is still out on this issue.

Hornstein (2001) for instance posits theta-features on heads that must be checked before the structure is shipped off to the interfaces. Theta-feature checking proceeds on lines very similar to regular phi-feature checking, i.e. these features can be checked by either

² In Chomsky's theory, theta-positions also cannot serve as intermediate landing sites.

externally merging DPs or by moving DPs from within a phrase marker. Under the second approach, the two types of Merge become even less distinct. Internal Merge seems to pattern alike with External Merge in almost all respects but one - i.e., in the former, computations take into consideration only elements that have already been introduced into the derivation. New elements from the numeration are not accessed by Internal Merge, unlike what we witness for External Merge.

1.2.3 Agree: “An engineering solution”?

The last fundamental operation attributed to UG is long-distance Agree that establishes agreement between two elements in a tree. Functional heads (v, T or C) are introduced into narrow syntax with a set of non-interpretable features that must be valued before the structure containing them are shipped off to the interfaces. Feature-values for these heads are obtained from DPs carrying identical features and this is accomplished via the operation Agree. DPs in turn must carry non-interpretable Case, which gets valued as a reflex of phi-feature checking with respective heads.³

The first crucial thing to note about this relation is its asymmetric nature. Only heads or probes can initiate the search for DPs or goals with appropriate features. The search is restricted to the domain of the probe’s sister or complement, which is presumably also computationally least expensive. In the words of Chomsky (2005a): “the complement of a head H should be the only domain accessible to operations driven by H, by conditions of minimal search, the core property of c-command...” (14). Agree is therefore restricted

³ In GB theory, Agree finds its precursor in the relation government.

between a probe and a goal that it c-commands, as schematized in (4) where probe σ agrees with α that it also (asymmetrically) c-commands.

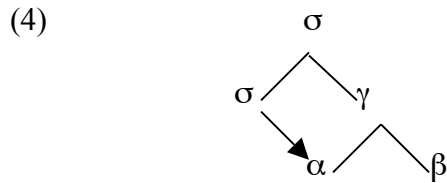

The second crucial thing to note about Agree is its dissociation from movement. Agreement between σ and α takes place long-distance; the goal is not required to move to the domain of the probe. It may however target a specifier of the probe (especially if the probe is also a phase head), but its movement will be triggered for reasons independent of phi-agreement (e.g., an EPP feature).

However, agreement cannot be arbitrarily long-distance. The probe must agree with the closest active (with an unvalued case) goal in its c-command domain. In case the closest DP turns out inactive for Agree, there are two possible scenarios: (i) the search terminates (a.k.a ‘defective intervention’ as will be detailed in chapter 4) with the probe either receiving a default value or no value at all⁴ or, (ii) the probe seeks out the next active goal in the structure. These two options are given below in (5). In (i), probe σ finds α but fails to agree with it due to its inactive status. Even though α is defective for Agree, it blocks σ from seeking out the more appropriate goal μ . In (ii) on the other hand, σ looks past α and agrees with μ instead.

⁴ Receiving no values of course endangers the derivation at the interfaces.

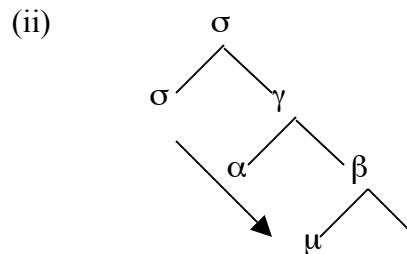
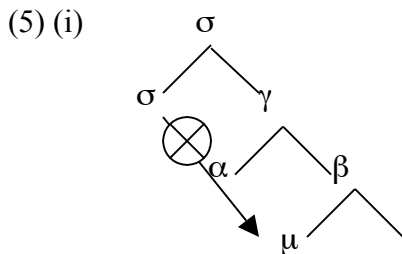

The question to ask at this point is if an operation like Agree can receive a “principled explanation” like Merge and Move/Internal Merge, i.e. whether something similar is found in other domains and/or if it satisfies interface conditions and follows from general economy considerations. With regard to the first point, phi-features and agreement are generally specific to human language. It is absent from special purpose symbolic systems, which implies that any operation underlying this particular phenomenon must also be specific to FL. We can then ask the next question: does Agree fall out from general economy considerations? As discussed above, Chomsky has argued that search into the complement domain of a head is computationally least expensive. Under this approach, an operation like Agree – where the head agrees with an item which is either its complement or contained in its complement - seems like an optimal choice made by the grammar; its existence at least apparently comports with general economy constraints. However both ideas - (i) only heads must initiate the search and (ii) search into the complement domain is computationally optimal - are completely stipulated. For instance, it is not at all obvious why search cannot be undertaken by DPs seeking heads to check off their non-interpretable case. Bottom-up search, with nominals searching tree-tops for potential ‘probes’ also appears computationally efficient and a perfectly legitimate option that the grammar could use. Consider in this regard the following scenario:

(6)

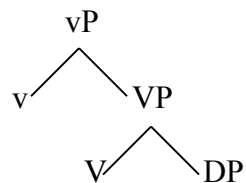

The tree sketched in (6) has a functional verbal head with a non-interpretable phi-set and a DP with unvalued case that must be checked before the structure containing them are shipped off to the interface systems. In Chomsky’s probe-goal system, the optimal situation is where *v* probes into its complement VP-domain to seek out the DP. A different and equally optimal solution would be one where the DP explores the top of the constructed tree (namely *vP*) for means to satisfy its case-requirements. In this approach, *vP* would bear the features of its verbal head, with the result that once constructed, the nominal will immediately seek it out for feature-checking. This option seems computationally as efficient as the first option. In light of this, it is hard to maintain that an asymmetric probe-goal system like Agree can be justified on grounds of computational efficiency alone.

Other problems for Agree come from its dependence on c-command.⁵ First, Chomsky himself identifies the dubious role of relations like c-command in narrow syntax: “The relation c-command is available, and expected, on very weak assumptions. The relation has played a large role in syntactic theory, though it may be that it does not function within narrow syntax but only in interpretation of the information it provides – that is, in

⁵ Unless specially mentioned, c-command is used here to imply asymmetric c-command. Mutual c-command is referred to as sisterhood.

mapping it to syntactic objects that belong to mental systems external to the language faculty itself. (Chomsky 2000:31) If true, then c-command is irrelevant to all narrow syntactic phenomena, including phi-agreement. This makes it doubtful that an operation controlling phi-agreement in narrow syntax can be grounded in c-command like Agree is. Long-distance Agree seems theoretically unrealistic when seen from this light.

Additionally, several researchers (cf. Epstein, Groat, Kawashima and Kitahara 1998; Hornstein 2005) have argued that c-command is not a primitive of the grammar. Rather, it is a direct consequence of the way the grammar operates. Below I summarize the main results of these two studies and then turn to show what implications they might hold for the operation Agree.⁶

As was most clearly noted in the works of Epstein et al (1998), c-command falls out naturally from the derivational workings of the system. They dub it ‘derivational c-command’ (7):

(7) Derivational C-command

X c-commands all and only the terms of the category Y with which X was paired/concatenated by Merge or Move in the course of the derivation.

⁶ See Frank and Vijay- Shanker (1999) and Frank, Hagstrom and Vijay- Shanker (2002) who claim that c-command is a primitive of the grammar, from which are derived relations like dominance and notions like roots and constituents. However simply restating these relations in terms of c-command does not necessary imply that the latter is not derived from other properties of natural language (see below for more).

The assumption is that structures are built in a bottom-up fashion. As elements are introduced into the workspace, they end up derivationally c-commanding whatever items they are merged with and also their ‘terms’, i.e. all elements contained in them. Take (8) for illustration.

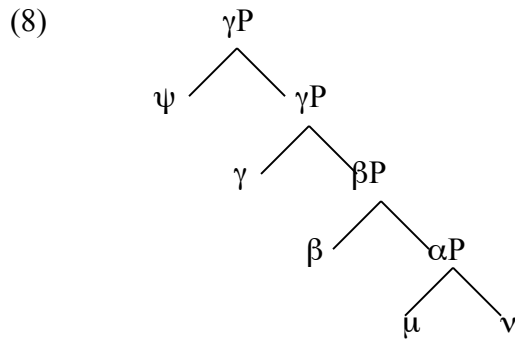

As in (8), head β , once merged with αP derivationally c-commands αP and all the elements that αP dominates (namely μ and ν). In a similar vein, when γ is merged with βP , it ends up derivationally c-commanding βP and all the elements that it dominates, namely head β , αP and its terms μ and ν . In Epstein et al’s view, c-command is a relation that falls out naturally from the way Merge operates; it is not a primitive of the grammar. The problem with their account, as Hornstein (2005) explicitly recognizes, is that even though they justify c-command as a natural relation, Epstein et al run short of providing an explanation for why grammar chooses c-command for its computations, instead of some other relation(s) that also fall out from Merge. As briefly alluded to in section 1.2.1, there are at least two relations that are directly deduced from Merge (i) ‘sisterhood’ (between μ and ν in (8)) and (ii) ‘immediately contain’ (as between αP and μ). Ideally all syntactic phenomena must be restricted to these two configurations, which are most

‘natural’ in that they are provided for free by the indispensable operation Merge (more on this later). The elementary operation of composition of relations gives us some new relations (cf. Chomsky 2000). I have already talked about c-command, which could be interpreted as composed from ‘sister (contain)’. In addition, there are numerous other relations that could be composed indirectly from Merge, including those corresponding to the transitive closure of ‘immediately contain’ (i.e. ‘contain’ as between βP and μ), ‘sister (sister)’ or the relation of ‘identity’ (eg. the sister of μ is ν whose sister is μ itself), ‘immediately contain (sister)’ (as between γ and ψ) or even ‘immediately contain (sister) (immediately contain) (sister)’ among others. Nothing in principle prevents the grammar from exploiting these relations as they are all indirectly obtained from Merge. In light of this, why c-command must be chosen for grammatical computations is a question that remains largely unresolved in Epstein et al’s work. Hornstein’s take on this issue, as I discuss below, is that the correct answer to this puzzle cannot be sought in the maneuverings of External Merge alone. Internal Merge and its application in different sub-theories are largely responsible for the systems’s apparent reliance on c-command.

Hornstein considers each of the domains where c-command applies and demonstrates how by adopting a slightly different approach, c-command “pops out in a system that uses simple natural primitive operations, and deploys them in a computationally optimal way” (pp.28). Here I concentrate on his alternative analysis for Condition A of the Binding Theory, which also holds an answer for why c-command may be relevant in this domain. Consider:

(9) John-i likes himself-i.

Sentence (9) is a typical instance of anaphora binding. The reflexive *himself* must be A-bound (c-commanded and co-indexed) with a clause-mate antecedent *John*. The question we have to ask here is why c-command must play such an important role in anaphora binding. Hornstein's alternative analysis for binding (that also helps derive c-command in this domain) bases itself on two main assumptions: (a) computations are monotonic increasing (i.e. they obey the Extension Condition that permits adding material only to the roots of trees) and (b) movement or internal merge can also target theta-domains. Once we adopt (a)-(b), (9) is given the following underlying representation (10), with the relevant derivational steps sketched in 11(i)-(iii).

(10) John-i likes John-self-i.

(11) (i) [V likes John-self]

(ii) [vP John [v [V likes __-self]]]

(iii) [TP John [vP John [v [V likes __-self]]]]

(iv) [TP John [vP John [v [V likes himself]]]]

The derivation – as shown in successive steps in (11) - starts off with merging *John* with *self* as a complement to lexical V as in (i) and then moving it via the specifier of vP for a second theta-role (ii) to the specifier of TP for case and EPP (iii). The stranded affix *self* finally ends up getting a case from V. An overt pronoun is merged with *self* to avoid a violation of the Stranded Affix Filter in (iv).

In this alternative account for binding, c-command emerges naturally from the interplay of core grammatical operations like Move and conditions on computational efficiency. The reason why antecedents must c-command co-indexed reflexives is not because this relation is a primitive of the grammar or that it is built into the definition of binding, but rather derives from the fact that the antecedent itself must target the root of a given phrase marker (Extension Condition) for case/phi-feature requirements and in the process ends up in a specific relation (asymmetric c-command) with the copy it leaves behind.⁷ In a nutshell, Hornstein demonstrates that not only is c-command not a primitive of the grammar, but that every syntactic phenomenon – where it apparently does play a role – relies crucially on the core transformation Move. C-command is merely an epiphenomenon that the grammar generates through the interplay of its core grammatical operations.⁸

There are two immediate implications that the above discussion might have for the operation Agree. The first is rather obvious: since Agree is dependent on c-command, and c-command is not a primitive relation, Agree (if it exists at all) is not a primitive transformation, unlike Merge or Move. Second, having c-command derived from Move, we are also forced to ask if this relation is actually essential for agreement; i.e., if it is

⁷ Similarly for linearization and movement (where a necessary condition is that the higher copy alias the moved element c-command the lower copy or trace), the relation c-command comes into effect primarily for the same reasons that I discussed above. Elements must target the root of a phrase marker; this creates a configuration where the moved element asymmetrically c-commands its copy/trace.

⁸ I must emphasize that this does not imply that c-command is not used in any grammatical phenomenon. Rather, all that can be drawn from the above discussion is that it is a consequence of narrow syntactic computations. Its use in various domains, for instance scope (see chapter 2 for movement driven scope effects) and binding is nowhere undermined by this approach to c-command.

necessary that there must exist a c-command relation between two items for them to agree with each other. This is a relevant question especially in light of Hornstein's observations that in every domain where c-command applies, it is derived from movement or displacement of the 'c-commanding' item. Given this, it is natural to question: if c-command applies in phi-computations, what derives it? I will take it one step further and ask in even bolder terms: is c-command even relevant for phi-feature computations? Previously I have noted that the 'complement domain as computationally efficient' argument for Agree is weak and cannot be maintained but as a stipulation. It has never been fully justified by Chomsky. A head probing a goal that it asymmetrically c-commands is not more computationally optimal than a nominal ('goal') seeking the root of the tree for feature checking. If this is right, then the answer to our second question is that c-command is not necessary to establish phi-agreement. There is nothing in the grammar that forces an asymmetric c-command relation between agreeing heads and DPs. For Agree, the implication is that it cannot be intrinsic to the grammar.

However, despite all these explicit conceptual conundrums related to its postulation, there exists a widespread acceptance of the notion of Agree, mainly based on empirical facts that I introduce below. It is therefore pertinent to ask if Agree remains merely as an engineering solution for these facts.⁹

⁹ There is a second agreement relation 'concord' in the grammar. Concord holds locally between an NP and its determiner, adjective phrases etc. I will have nothing to say on this operation here, though I refer to it to at certain points of my analysis. I will simply assume that concord involves feature sharing between two items that do not fit into the probe-goal category. The details of this operation are left pending.

1.3 Phi-agreement and the sisterhood relation

But before I proceed to discuss the empirical base for Agree, I must address the following question: if not Agree, then what must be the grammatical operation that underlies phi-agreement? From our discussion so far on minimalist goals, the optimal solution seems to be Merge or Move. Being core operations of the grammar, they must be able to determine all narrow syntactic phenomena, including agreement. If true, agreement must be carried out in one of the following configurations:

(12) (i)

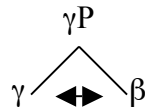

(ii)

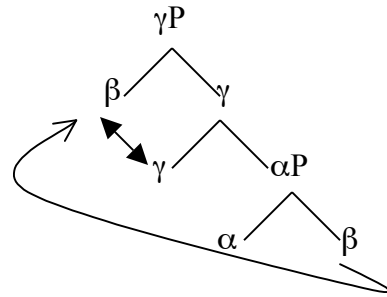

The diagram in 12(i) shows a head-complement relation formed by externally merging β to γ , whereas (ii) has γ and β in a specifier-head relationship, established by internally merging the latter into the domain of the former. I have noted previously that sisterhood emerges for free from Merge. That agreement must utilize this relation is therefore unsurprising. The status of a specifier-head relation is however much more controversial, as it necessitates positing a different relation – m-command – in the grammar. M-command does not follow directly from Merge (though a composition of relations can indirectly deduce it) and hence, its utilization for phi-agreement needs to be motivated. In this regard, 12(ii) is at least apparently not an ideal configuration for agreement. A possible solution to this problem is available once we adopt the basic tenets of Bare

Phrase Structure Theory. According to Chomsky (1994), narrow syntax recognizes only maximal and minimal projections (X₀s and XPs). Intermediate bar-levels (X' s) are ignored for narrow syntactic computations. A category that does not project further is a maximal projection while a category that is not a maximal projection is a minimal projection. Schematically, 13(i)-(ii). αP is the maximal projection in 13(i) after merging α with βP , but once a new item γ is added to αP , it transforms itself back to a minimal projection α as in 13(ii).

(13) (i)

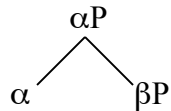

(ii)

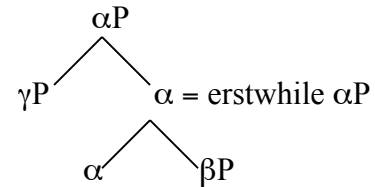

Once we seriously adopt these ideas, relations like m-command become superfluous. To put it in more concrete terms, relations like m-command work in a system where narrow syntactic computations first take into consideration intermediate bar-levels and secondly, only the original head carries the relevant features. This is shown in (14).

(14)

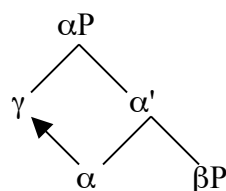

However, in a system where there are no bar-levels and features are percolated up to whatever is the next highest projection of that head, relations like m-command become

irrelevant. For illustration, consider (15). In (i), γ targets the root of the phrase marker αP , (which carries the appropriate features) and subsequently merges with it as depicted in (ii). Once αP merges with γ , creating a larger structure in the process, it is once again deemed by narrow syntax as a minimal projection. It is this head, I assume, that enters into agreement with γ , and not the original head. Importantly, this implies that the actual agreement process takes place between a DP and a head and not the maximal projection of that head.

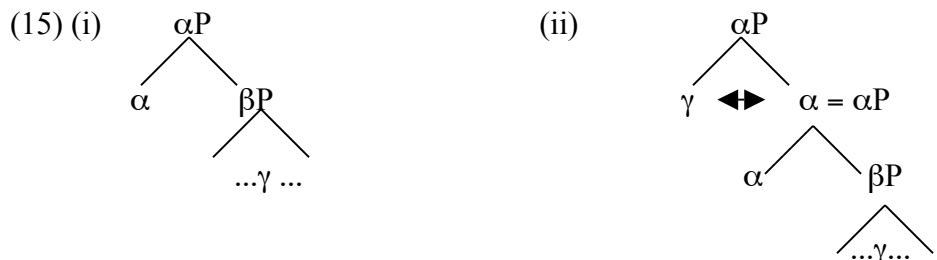

The same holds in a structure with multiple specifiers. Observe (16) in this regard where the head α hosts multiple items (γ and ψ) in its ‘specifiers’.¹⁰ Given the current line of reasoning, ψ and γ agree with their respective α sisters; there is no relation between them and the lowest α .

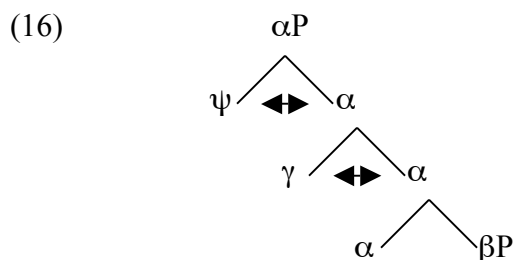

¹⁰ Terms like ‘specifier’ and ‘complement’ are simply notational variants and roughly correspond to elements first-merged and late-merged to any given head. For the rest of the dissertation, I will be using these terms only with their new connotations.

In a nutshell, what I have shown above is that agreement must always ensue between sisters. Only two elements that are directly merged with each other either via External Merge (as in 12(i)) or Internal Merge (as in 12(ii)) can agree with each other. Relations like asymmetric c-command and m-command are not considered for narrow syntactic computations.¹¹

Let me end this section with some quick remarks on ‘adjunction’ and ‘domain’, two terms that I will frequently use in the chapters to follow. I adopt the standard assumption that adjunction creates multiple segments of the phrase adjoined to, namely $\langle \alpha P, \alpha P \rangle$ as shown in (17).

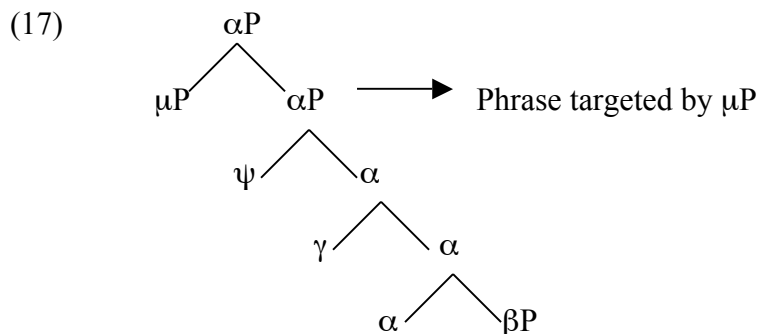

I will assume that adjunction is not a possible checking configuration. The maximal projection αP that μP targets, lacks non-interpretable features (as it has already checked them at prior derivational points). Agreement cannot ensue between μP and another maximal node αP .

¹¹ Norbert Hornstein (person communication) suggests that m-command can be justified by defining it as a relation between a head and items in its domain.

Regarding domains, I take them as denoting the set of nodes dominated by any given head. Given this definition, only specifiers (γ , ψ) and complements (βP) are included in the domain of the head. Adjoined elements (μP) on the other hand, are excluded from the domain as they are contained, and not dominated by the head.¹²

1.4 The Empirical Support for Agree

The discussion so far has led us to the following conclusion. The Faculty of Language - narrow sense (FLN) has only Merge and Move (itself a variant of Merge) as its basic operations. All narrow syntactic phenomena must in principle, be accomplished via them. There is no principled explanation provided for operations like Agree; neither is it present in any guise in other symbolic systems nor can its existence be justified on general economy grounds.

That said, in recent years, a substantial amount of empirical support has emerged in support of Agree. The most convincing piece of evidence comes from long-distance agreement (LDA) patterns, wherein a matrix functional head is seen to agree with an argument of its embedded clause. Crucially, the argument trigger surfaces inside the complement clause, which is taken to indicate that agreement has indeed taken place long-distance (i.e. without moving the nominal to the ‘domain’ of the agreeing head). Schematically (18), where agreement obtains between α and β separated by a clause-boundary.

¹² α dominates β if all segments of α dominate β .

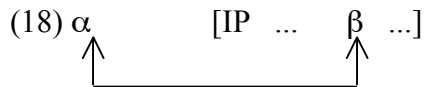

English expletive-associate constructions (19) are the prototypical cases of long distance agreement. The associate *several men* controls third person plural agreement on the matrix predicate *seem* without (apparently) undergoing overt movement to the specifier of a main clause functional head.

(19) There *seems/seem to be several men in the room.

A quick survey of the literature on LDA patterns brings out several other cases of long distance agreement. They can be broadly divided into two types: (i) those that hold across infinitivals and (ii) those that hold across finite clauses. The former is attested in languages like Chamorro (20), Hindi-Urdu (21), Itelmen (22) and Kashmiri (23) among others, while the latter type is found in Chuchkee (24), Innu-aimun (25), Passamaquoddy (26), Tsez (27) etc.

(20) In-tutuhun mang-anta
 1PL.RL.TR-begin inf.PL.IN-sing
 ‘We began to sing’

- (21) Johnne [roTii khaaniin] chaah-iin.
 John-erg. bread-acc.fem. eat-inf.fem. want.fem.perf.
 ‘John wanted to eat bread’
- (22) na antxa-bum=nin kma jebna-s
 he forget-1sg. OBJ=3.CL me meet-inf.
 ‘He forgot to meet me’
- (23) Raam-an che hameeSI yatshiImatsI panInis necivis khAAtrI koori
 vuchini.
 Ram-erg. be.fem.pres. always wanted.pl.fem. self-dat. son.dat. for girls
 see-inf.pl.fem.
 ‘Ram has always wanted to see girls for his son’
- (24) ənan qəlyiļu ləŋərkə-nin-et [iŋqun Ø-rətəmpəv-nen-at qora-t].
 he-inst. regrets-3-pl. Comp 3sg-lost-3-pl reindeer-pl.nom.
 ‘He regrets that he lost reindeers’
- (25) N-u î-tshissenim-âu tshetsh î mupihtâshkuenit kassinu kâuâpikueshit
 1-want-know-3 if visited-2/inv. every priest
 ‘I want to know of them if every priest visited you’
- (26) Susehp ‘-kosiciy-à akòm eli Muwin kisi-mil-at
 Wiphun
 Susehp 3-know.TA-dir.obv.p. snowshoe-obv.p. comp Muwin perf-give-3com.
 Wiphun.
 ‘Susehp knows that Muwin gave Wiphun snowshoes’

(27) eni-r [uz-a magalu b-ac-ru-li] b-iy-xo.
mother-dat. [boy-erg bread.III.abs. III-eat-pstprt.nmlz] III-know.pres.
‘The mother knows the bread, the boy ate’

An initial glimpse at these sentences suggests that the grammar allows agreement to take place long-distance across both tensed and tense-less clause boundaries. Agreeing heads and their DP triggers are not linearly adjacent to each other, suggesting that they do not form sisters at any derivational point. If these empirical facts are to be taken at their face value, then they provide strong support for the claim that there exists a separate operation for agreement that is distinct from Merge and Move. Perhaps then, this is one ground where our minimalist expectations conflict with the empirical evidence.

This apparent contradiction constitutes the theme for the rest of the dissertation. I take up representative cases of LDA in each of the following three chapters and show how with a careful unpacking of these structures, we can reanalyze a number of these facts.

1.5 Structure of the Dissertation

The rest of the dissertation is divided into three main chapters. In chapter 2, I consider cases of agreement across infinitivals. There are two prevalent analyses that have come up for these structures: Multiple Agree and AGREE. The first assumes that a single head can agree simultaneously with two nominal (or nominal-like) expressions. Under this approach, agreement and case-checking both take place long-distance without triggering movement for the nominal. In the second approach, agreement also takes place long-

distance. However unlike the former, the agreement triggers are already case-valued in their base-generated positions. As opposed to these approaches, I claim that these DPs cannot be case-checked before they enter into phi-computations with main-clause heads, in strict adherence to Chomsky's (2000) Activation Condition that restricts phi-agreement to non-case-marked DPs. Secondly, DPs must move to the domains of heads they agree with (28):

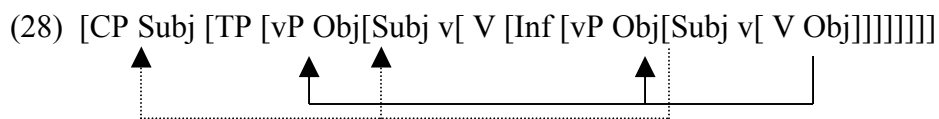

As shown in (28), the embedded object moves through the specifier of lower vP to its final destination in the specifier of higher vP. Under this approach, what is seemingly long distance agreement is actually phi-agreement between two sisters.

In chapter 3, I discuss agreement across finite boundaries and demonstrate how revealing the semantics of these constructions can direct us to a better alternative for them. The general consensus in the literature is that they are derived by long-distance Agree. On the assumption that finite clauses have legitimate case-checkers, agreement triggers are also case-marked internal to the lower clauses, in obvious violation of the Activation Condition. I show how these approaches are problematic, and suggest that these cases are derived by moving the agreement trigger to the domain of the main-clause agreeing head. This is a case of sideways movement, whereby an embedded item moves out of its base-generated clause into another (disjoint) clause. Schematically:

(29) [CP-1 [TP-1[vP-1 obj [v[VP-1 obj]]]]] [CP-2 obj [CP-2 ...[vP-2 obj]]]

The diagram shows a syntactic tree structure. On the left, a bracket groups [CP-1 [TP-1[vP-1 obj [v[VP-1 obj]]]]]. On the right, a bracket groups [CP-2 obj [CP-2 ...[vP-2 obj]]]. A vertical line descends from the 'obj' position of CP-2, then moves left and up to point at the 'obj' position of VP-1, indicating movement.

In (29), the object of the lower clause (CP-2) sideward moves into the complement position of V-1, where it receives a second theta-role. It then moves higher up to the specifier of vP-1, where it gets a case-value from v, in return for checking the phi-set on the head. The object may then undergo further A-bar movement to the edge of the tree.

In chapter 4, I tackle the issue of ‘defective intervention’. Chomsky (2000) suggests that a probe’s search is sometimes interceded by an intervening DP, even when it itself is an ineligible candidate for agreement. Evidence for this approach mainly comes from Icelandic raising constructions (30) and Japanese honorification structures with ditransitives (31).

(30) Pad virdist/*virdast einhverjum manni hestarnir vera seinir.
 It-expl. seem-sg/*seem-pl. some man-dat. the horses-nom. be slow-nom.
 ‘It seems a man finds the horses slow’

(31)*Hanako-ga Taro-ni Tanaka sensei- o go-shookai-si-ta.
 Hanako-nom. Taro-dat. Prof. Tanaka-acc. introduce-OH-past.
 ‘Hanako introduced Prof. Tanaka to Taro’

The presence of intervening items (the experiencer and the indirect object in (30) and (31) respectively) causes the probes to terminate their search before they find the appropriate goals (the embedded subject and the direct object). The interveners are

defective in that they are either already case-marked or do not have the adequate features to check the phi-set on the probe. As a result, the probes end up either with default morphology or with unchecked features leading to derivational non-convergence. Contrast these structures with (32) and (33) where the apparent interveners are missing.

(32) Mer virtust [paer vinna vel]

me-dat. seemed.3pl. they-nom. work well

‘They seemed to me to work well’

(33) Taro-ga Tanaka sensei-o o-yobi-si-ta

Taro-nom. Prof. Tanaka-acc. call-OH-past.

‘Taro called Prof. Tanaka’

I show some problems with the notion of defective intervention and suggest that the effects actually follow from general constraints on movement. In line with what is proposed in chapters 2 and 3, I claim that DPs must move to the domains of heads to be able to agree with them. However under certain situations, the presence of a higher DP blocks A-movement for a lower DP; the former holds a possible A-landing site for the latter and moving over it leads to an inevitable minimality violation. The lower DP may adjoin to the phrase hosting the higher nominal or even move to one of its other specifiers. However these positions are not potential agreement sites and are therefore considered by the grammar as A-bar positions. Once a nominal moves into an A-bar position, it is disallowed from targeting a higher A-position by the ban on Improper Movement. If true, absence of agreement cannot be blamed on the blocking effects

caused by intervening goals on potential long-distance agreement relations between probes and lower nominals. Rather, it results from the inability of potential goals to A-move to the domains of their targets.

I summarize the main results of the dissertation in the final chapter. Some potential problems for my analysis are also discussed here, along with some tentative solutions.

CHAPTER 2

ON AGREEMENT ACROSS RESTRUCTURING INFINITIVALS

This is the first of the three chapters devoted to questioning the empirical bases for Agree. My focus is on LDA sentences with restructuring predicates in Hindi-Urdu, Itelmen, Chamorro and Kashmiri. A critique of previous Agree-based accounts is provided along with a possible movement alternative for the phenomenon. Evidence for the movement alternative comes from certain interpretive effects associated with agreeing DPs. My analysis has further implications for the phenomenon of restructuring and covert scope-shifting operations like quantifier-raising/QR that I also detail in this chapter.

The chapter is organized as follows. The first section introduces cases of LDA across restructuring infinitivals, along with a brief discussion of the phenomenon of restructuring. Following that in sections 2 to 4, I reanalyze Hindi-Urdu LDA sentences, ending with a short discussion on Itelmen LDA. In section 5 are brought up more cases of LDA from Chamorro. In section 6, I discuss the mechanisms leading to optional agreement and then go on to discuss in section 7 case-checking inside Kashmiri infinitivals and the repercussions, if any, this has on the generation of LDA in this language. Section 8 and 9 are on restructuring and QR. Section 10 concludes the chapter.

2.1 On Restructuring & Agreement

Long distance agreement across infinitivals is attested in a wide variety of languages including Basque (Etxepare 2005), languages of the Algonquian family such as Blackfoot

(Frantz 1978), Fox (Dahlstrom 1995) and Cree (Massam 1985), Nakh-dagestian languages like Tsakhur (Kibrik 1999) and Itelmen of the Chukotko-Kamchatkan language family (Bobaljik and Wurmbrand 2003, 2005), the Austronesian language Chamorro (Chung 2004) and Indo-Aryan family members, Hindi-Urdu (cf. Mahajan 1990; Boeckx 2004; Bhatt 2005) and Kashmiri (Wali and Kaul 1997; Subbarao and Munshi 2003).¹ For this chapter, I focus exclusively on LDA patterns in Hindi-Urdu (1), Itelmen (2), Kashmiri (3) and Chamorro (4).² While the first three allow their matrix verbs to agree with objects of their complement clauses, long-distance agreement in the latter holds between the matrix subject and the infinitive.

(1) Johnne [roTii khaanii] chaah-ii.

John-erg. bread-acc.fem. eat-inf.fem. want.fem.perf.

‘John wanted to eat bread’

(2) na antxa-bum=nin kma jebna-s

he forget-1sg.obj=3.cl me meet-inf.

‘He forgot to meet me’

(3) raam-an yat-I koori vuchini.

Ram-erg. wanted.fem.pl. girl.fem.pl. to see.fem.pl

‘Ram wanted to see the girls’

¹ See Polinsky (2003) for a comprehensive review of languages with LDA.

² For the most part, I restrict the discussion to standard Hindi-Urdu, while only occasionally referring to non-standard versions.

(4) Man-o'sun i famalao'an ma-dipendi siha gias Juan.

Pl.rl.in.bored. the women 3pl.rl.tr-depend themselves loc. Juan.

'The women are tired of depending on Juan'

An initial glance at these structures indicates their parallelism with restructuring phenomena in other languages. Restructuring predicates typically select infinitival complements whose arguments are accessible for matrix clause computations (pertaining to phi-agreement and movement).³ Non-restructuring predicates, on the other hand, host infinitival complements that pattern like finite clauses in not allowing clause-external movement and agreement. Take for instance, the Italian sentences in (5) and (6). As shown below, clitic-climbing across infinitival boundaries is possible only with restructuring predicates like *want* (5). Non-restructuring predicates like *detest* somehow render such movement impossible (6).

(5) Lo volevo [vedere t-cl subito]

Him I-wanted [see t-cl immediately]

'I wanted to see him immediately'

(6) *Lo detesto [vedere t-cl in quello stato]

Him I-detest [see t-cl in that state]

'I detest seeing him in that state'

³ The restriction does not hold for A-bar movement, which is generally immune to clause (finite as well as non-finite) boundaries.

(i) Who did John think that Mary thought that Peter liked?

(ii) Who did John believe to be a genius?

Wurmbrand (2001) suggests that the restructuring/non-restructuring difference – as evidenced in (5) and (6) – reflect two distinct phrase structures for infinitivals.⁴ While those selected by non-restructuring predicates are full-blown CP or TP clauses, infinitivals serving as complements to restructuring predicates are bare-VPs and are completely devoid of all functional projections.⁵ Bare VPs (but not CPs/TPs) are resilient to clause-external computations, which explains why intra-language, certain infinitivals appear easier to perforate than others. These two types of infinitivals are schematically represented in (7) and (8) below.

(7) [CP-2 [TP-2 [vP-2 [VP-2 [CP-1 [TP-1 [vP-1 [VP-1]]]]]]]] => Non-restructuring

(8) [CP-2 [TP-2 [vP-2 [VP-2 [VP-1]]]]] => Restructuring

As proof for the functional deficiency of restructuring complements, Wurmbrand provides instances of long passives from Italian (9) and German (10). The fact that long passives are exclusive to restructuring (see the ungrammatical German long passive example in (11) with a non-restructuring predicate), she claims, is further indicative of the absence of functional layers within the restructuring infinitival. Arguments of only restructuring subordinate clauses are case-dependent on main-clause functional v in active sentences and T in long passives.

⁴ I concentrate here on what Wurmbrand terms ‘lexical restructuring’ predicates.

⁵ Restructuring has been extensively studied by several researchers, including Aissen and Perlmutter 1976, 1983; DiSciullo and Williams 1987; Cinque 1997a, 1997b, 2000; Fanselow 1989; Lujan 1980; Kayne 1989, 1990, 1991; Napoli 1981; Sternefeld 1990; Strozer 1976; Rutten 1991; Roberts 1993, 1997; Grewendorf and Sabel 1994; Sabel 1994/1996; Kiss 1995; Meurers 2000; Wurmbrand 1997, 1998a,b,c,d among others.

(9) Le nuove case furono iniziate a costruire negli anni 20's

The new house were started to build in the 20's

'They started to build these [new] houses in the 20's'⁶

(10) dass der Traktor zu reparieren versucht wurde

that the tractor-nom to repair tried was

'That they tried to repair the tractor'

(11) *dass der Trakto zu repairen geplant wurde

that the tractor-nom. to repair planned was

'That they planned to repair the tractor'

In a much similar vein, Hindi-Urdu, Itelmen, Kashmiri and Chamorro LDA is also restricted to a select set of restructuring predicates whose clausal complements and their internal constituents are accessible to matrix heads for phi-checking. This view serves as the working hypotheses of almost every previous research done on the topic. The general consensus in the literature is that LDA across infinitivals falls out naturally once we assume that languages hosting them are also geared to the restructuring/non-restructuring distinction. While LDA is restricted to VP-complements of restructuring predicates, non-LDA structures (like the Hindi-Urdu (12)) involve non-restructuring infinitivals that are underlying CPs or TPs, capable of assigning structural case values to embedded arguments. By virtue of being optionally case-marked in the downstairs clause, arguments fail to assign their phi-values to heads in the main clause.

⁶ Wurmbrand (2001) credits this sentence to Cinque (1997a).

(12) Johnne [roTii khaanaa] chaahaa.

John-erg. bread-acc.fem. eat-inf.def. want.def.perf.

‘John wanted to eat bread’

Thus so far, we have had theories of LDA embedded in theories of restructuring. I take a different approach to the problem here. I do not start with the preconception that restructuring and non-restructuring infinitivals have different underlying phrase structures. Rather, my contention is that optional agreement follows from different case-checking mechanisms in narrow syntax. LDA arises when objects are forced to cross infinitival boundaries where they fail to check their structural case against functional heads. It is absent when a different, case-checking mechanism (eg. partitive/weak structural case checking) is executed within the infinitival resulting in case-valuation for the embedded argument and ultimately disabling it for further A-related computations. Under this approach, restructuring and non-restructuring predicates are non-distinct in terms of their sub-categorization frames.

2.2 Hindi-Urdu Agreement

Let me begin with Hindi-Urdu. To start with some basic information, this is a split ergative language, implying that its agreement patterns are contingent on whether it uses the nominative-accusative system (with non-perfective tense) or the ergative-absolutive system (restricted to the perfective tense). Consider (13), a nominative subject construction in this regard.

(13) John roTii khaata he.

John-nom. bread-acc.fem. eat.sg.mas. be.3P.sg.

‘John eats bread (habitually)’

Nominative subjects in Hindi-Urdu trigger obligatory phi-feature agreement (person, number and gender) with the verb-auxiliary complex. Objects are case-marked accusative and are incapable of controlling verbal agreement in the presence of a nominative subject, as shown by the unacceptable (14).⁷

(14) *John roTii khaatii he.

John-nom. bread-acc.fem. eat.fem. be.3P.

‘John eats bread (habitually)’

Alternatively, subjects can also be ergative case-marked (coded by the *ne*-morpheme), in which case they are unable to trigger verbal agreement. The verb instead agrees with the object in gender (15).^{8, 9,10}

⁷ Both nominative and accusative Cases are morphologically null. Accusative is sometimes argued to be overtly marked with *ko*, though the case-status of the morpheme is unclear at this point. Pronominals, names and other definite/specific objects also bear a ‘default’ *-ko* marker, but these have clear semantic connotations unlike what is expected of a structural case-marker. The morpheme is also homophonous with the dative case marker.

⁸ There is some speaker variation with respect to object agreement, with some using it only optionally.

⁹ Agreement in finite embedded clauses follow the same pattern, as shown in (i).

(i) Johnne sochaa ki Peterne roTii khaalii he.
John-erg. think that Peter-erg. bread.fem. eat.fem. be-past.
‘John thought that Peter had finished the bread’

¹⁰ Non-subject pronominals are overtly marked with specific/definiteness markers and like all overtly marked nominals, they too fail to control verbal agreement.

(15) Johnne roTii khaayii thii.

John-erg. bread-acc.fem. eat.fem. be.fem.perf.

‘John had eaten bread’

The general take in the literature is that agreeing objects as in (15) are case-marked accusative by *v* (cf. Mahajan 1990; Boeckx 2004 and Bhatt 2005 among others), even though they are often termed as ‘absolute’. This claim can be independently supported using the three diagnostics suggested by Legate (2005) to identify sub-classes of ergative-absolutive languages.^{11,12} These diagnostics are: (i) the behavior of intransitive subjects and transitive objects in infinitivals, (ii) number of absolutive DPs available per clause and (iii) the nature of agreement triggered by the subject and object. Using this method, we will eventually be able to evaluate first, the ergative-absolutive language group that Hindi-Urdu belongs to and second, the case-source for its objects.

Legate claims that ergative-absolutive languages can be broadly divided into two categories. The first class includes the *absolutive-as-nominative* languages where T checks nominative case on both intransitive subjects and transitive objects. All absolutive case-marked DPs in this sub-group are valued nominative by a tense head. The second class on the other hand has two different case-checkers: T for intransitive ‘nominative’ subjects and *v* for ‘accusative’ objects, though both end up marked with default

¹¹ See Murasugi 1992; Bittner 1994; Bittner and Hale 1996a,b and Ura 2001 for claims that absolutive objects cross-linguistically check (nominative) case against T. This is obviously not what I claim finally for Hindi-Urdu.

¹² Legate (2006) has an extensive discussion on Hindi-Urdu, including many of the observations alluded to below. However her analysis differs in that she contends that accusative objects value the phi-set on T in transitive constructions with ergative subjects, even though they receive an accusative case value from *v*.

‘absolute’ morphology. Languages belonging to this sub-group are appropriately termed the *absolute-as-morphological-default* languages.

These two types of languages behave differently with regard to the three diagnostics briefly alluded to above. In the former type, since T is the sole absolute case-checker, intransitive subjects and transitive objects fail to appear in infinitivals (since they lack a tense head). Secondly, a single clause can have at most one absolute DP since T may case-check only one DP as nominative per clause. And finally, subject and object agreement are non-distinct as they are triggered against the same head. This is illustrated by the following Georgian examples in (16) and (17), taken from Legate (2005).

(16) glex-i tesav simind-s
peasant-nom. he.sows.it.I.1 corn-Dat.

‘The peasant is sowing corn’

(17) glex-ma datesa simind-i
peasant-erg. he.sowed.it.II.1. corn-nom.

‘The peasant sowed corn’

Languages of the second type differ in all three respects. First, object case is not dependent on T and hence an absolute object can appear inside an infinitival with an abstract nominative case value from v. Subjects are licensed by T and are consequently absent from tense-less clauses. Secondly, since absolute is the default marker, it appears on multiple DPs in any given clause, including applicative and postpositional

objects. Lastly, these languages morphologically distinguish subject agreement with T from object agreement with v. Hindi-Urdu is a representative example of this sub-type, as I demonstrate below.

In Hindi-Urdu, absolutive objects can appear in infinitivals unlike intransitive subjects. Consider:

(18) John chaahtaa/*chaahatii he roTii khaanaa.

John-nom. want.3p.sg.mas./*fem be.3p.sg. bread-acc.fem. eat.inf.

‘John wanted to eat bread’

(19) *John chaahtaa he Peter hasnaa.

John-nom. want.3p.sg.mas. be.3p.sg. Peter-nom. laugh-inf.

‘John wanted Peter to laugh’

Sentence (18) is good with the infinitival hosting an overt object. The lack of object agreement on the matrix verb is further evidence that object case in this particular instance is not dependent on a main clause functional head. Unlike objects, overt subjects are ruled out from infinitivals, as the unacceptable (19) shows. Also notice that the embedded verb in (18) does not enter into standard structural case checking relations with the object. Unlike simple clauses like (15), infinitives cannot independently bear overt object agreement morphology. The exact nature of object case in infinitivals (i.e. whether it is structural or not) will be taken up in more detail later on.

Moreover, we find Hindi-Urdu objects of benefactive, comitative and instrumental postpositions carrying a default (null) case marker, yet another characteristic of absolutive-as-default sub-group of languages. This is illustrated with the following set of sentences.¹³

(20) *mina-ne kalam se likhaa.*

Mina-erg pen with write-past-def.

‘Mina wrote with a pen’

(21) *me-ne us addmii ke-liye kaam kiya.*

I-erg. that man for work do-past-def.

‘I worked for that man’

(22) *usne billi-ko dande se maara*

He-erg. cat stick with hit-past-def.

‘He hit the cat with a stick’

Finally, Hindi-Urdu has distinct object agreement morphology, which is restricted to gender (23) whereas its nominative subject agreement necessarily involves person and number morphology as well (24).

(23) *Mene roTii khaayii*

I-erg. bread.fem. eat-fem.perf.

‘I ate bread’

¹³ I assume here that *se* (with) and *ke-liye* (for) are postpositions, and not case-markers.

(24) Me dORtaa hu.
 I-nom. run-1p.sg.mas be-1p.sg.prst.
 ‘I run (habitually)’

Evidently, person-less agreement is a general characteristic of agreement against functional *v* (see chapter 4 for more). Assuming that Hindi-Urdu is not an exception to this generalization, the presence of distinct subject and object agreement morphology is yet another indication that the language has different functional heads for checking case on intransitive subjects and transitive objects.

In a nutshell, as far as the diagnostics for classifying ergative-absolutive languages are concerned, Hindi-Urdu patterns closely with other *absolutive-as-morphological-default* languages. I therefore contend that the ‘absolutive’ objects of ergative subject constructions are in reality case-valued structural accusative by *v*. With that, let us now turn to long-distance agreement constructions in the language.

2.2.1 Cross-clausal agreement in Hindi-Urdu

Cross-clausal or long-distance-agreement occurs typically with control predicates like *want*, *forget*. Consider (1) again, repeated as (25) below, where the matrix control predicate agrees in gender with the object of its infinitival complement.¹⁴

¹⁴ The following example shows both verbs agreeing with the masculine *peR* (tree).
 (i) Maryne [peR dekhnaa] chaahaa.
 Mary-erg. tree-acc.masc. see-inf.masc. want.masc.perf.
 ‘Mary wanted to see trees’

(25) Johnne [roTii khaanii] chaah-ii.

John-erg. bread-acc.fem. eat-inf.fem. want.fem.perf.

‘John wanted to eat bread’

LDA is however not obligatory and the matrix verb may appear with default verbal agreement, as (26) illustrates.¹⁵

(26) Johnne [roTii khaanaa] chaahaa.

John-erg. bread-acc.fem. eat-inf.def. want.def.perf.

‘John wanted to eat bread’

There are various constraints on Hindi-Urdu LDA, which are as follows. First, it is confined to ergative subject constructions, which is not surprising given that object agreement is permitted on *v* only when *T* fails to trigger agreement with ergative subjects. Nominative subject sentences like (27) are, as expected bad with object cross-clausal agreement and good only with subject agreement (28).

¹⁵ LDA in doubly embedded clauses like (i) is odd.

(i) ??Johnne roTii khaanii bhulnii chaahii.
John-erg. bread-fem. eat-inf.fem. forget-inf.fem. want-fem.perf.
‘John wanted to forget to eat bread’

The same observation holds for sentences without cross-clausal agreement (see (ii)). This suggests that the slightly degraded status of (i) cannot be due to long-distance agreement.

(ii) ??Johnne roTii khaanaa bhulnaa chaahaa.
John-erg. bread-fem. eat-inf.def. forget-inf.def. want-def.perf.
‘John wanted to forget to eat bread’

(27) *John [roTiyaan khaanii] chaahiin thiin.
John-nom. bread-acc.pl.fem. eat-inf.pl.fem. want.pl.fem. be.pl.fem.perf.

‘John wanted to eat bread’

(28) John [roTiyaan khaanaa] chaahtaa thaa.
John-nom. bread-acc.pl.fem. eat-inf.def. want.sg.mas be.3P.sg.perf.

‘John wanted to eat bread’

LDA is also restricted to infinitivals. Structures like (29) are out with the embedded object trying to trigger agreement on the matrix verb across a finite clause. Default verbal morphology is the only option here, as (30) shows.

(29) *Johnne chaahii (ki) [voh roTii khaayii]
John-erg. want.fem. (that) he-nom bread-acc.fem eat-pl.fem.

‘John wanted that he should eat bread’

(30) Johnne chaahaa ki [voh roTiyaan khaaye].
John-erg. want.def. that he-nom. bread-acc.pl.fem. eat-subjunc.3P.sg.

‘John wanted that he should eat the bread’

It is important to point out here that the unacceptability of (29) cannot be blamed entirely on the presence of an intervening DP. There are numerous constructions where intervening nominals do not produce the expected intervention effects. (31) is one such instance, where long-distance object agreement is clearly immune to the presence of an intervening indirect object.

(31) Johnne [Peterko roTii denii] chaahii.

John-erg. Peter-dat. bread-acc.fem. give-inf.fem. want-fem.perf.

‘John wanted to give Peter (some) bread’

It is also necessary that the embedded verb bear the same agreement morphology as the matrix verb. In the LDA sentence (25), both predicates must agree in gender with the object. On the other hand, if the matrix verb bears default morphology as in non-LDA structures like (26), the embedded verb must also follow suit. Embedded agreement in LDA is therefore ‘parasitic’ on matrix agreement. All cases of agreement mismatch between the two verbs are bad (32)-(33).¹⁶

(32) *Johnne roTii khaanii chaahaa.

John-erg. bread-acc.fem. eat-inf.fem. want.def.perf.

‘John wanted to eat bread’

(33) *Johnne roTii khaanaa chaahiin.

John-erg. bread-acc.fem. eat-inf.def. want.fem.perf.

‘John wanted to eat bread’

With the main characteristics of Hindi-Urdu LDA in place, I now direct your attention to previous attempts to derive these sentences via the operation Agree.

¹⁶ Some dialectal variations are discussed later.

2.3 Unpacking Previous Agree-based Accounts

LDA in Hindi-Urdu has been extensively studied by a number of scholars (cf. Davison 1988; Mahajan 1990; Butt 1995; Boeckx 2004; Bhatt 2005 among others). Here, I will focus on the Agree-based studies of Boeckx (2004) and Bhatt (2005).

For both Boeckx (2004) and Bhatt (2005), Hindi-Urdu LDA closely resembles lexical restructuring phenomena in other languages, such as clitic climbing in Romance or long passives in German.¹⁷ To this end, they adopt Wurmbrand's (2001) claims for lexical restructuring predicates that I briefly alluded to in section 2.1. Let us consider it in more detail now.

According to Wurmbrand, lexical restructuring (control) predicates choose bare VP-complements that are distinguished by (i) their inability to host PRO-subjects and (ii) the absence of a functional verbal head to check case on direct objects. These subject-less

¹⁷ As opposed to functional restructuring predicates, which generally include auxiliaries and modals. Some instances of cross-clausal agreement with functional predicates are found in Hindi-Urdu too, but I will ignore them here. These are cases like (i)-(ii) with matrix light verbs *let* and auxiliaries *should* (see Butt 1997) respectively.

(i) Nadiane saroshko gaaRii chalaane dii.
Nadia-erg Sarosh-acc. car-acc.fem.sg. drive-ger.Obl. let.fem.sg.perf.
'Nadia let Sarosh drive car'

(ii) Raamko [davaaii khaa lenii] chaahiye thii
Ram-dat. [medicine-fem. eat take-inf.fem] should be-fem.
'Ram should have taken medicine'

LDA is (generally) obligatory in such cases, as the unacceptable (iii) shows. Agreeing DPs in (i) and (ii) are also non-specific.

(iii) *Raamko [davaaii khaa lenaa] chaahiye thaa.
Ram-dat. [medicine-fem. eat take-inf-sg.mas.] should be-sg.mas.
'Ram should have taken medicine'

A tentative proposal is that these constructions involve complex-predicate formation; i.e they are analogous to 'functional' restructuring verbs in languages like German (see Wurmbrand 2004). Complex-predicate formation yields mono-clausal structures that enable their DP-objects to agree with clause-mate functional heads.

phrases (without functional heads v/T) are then counted as properties at the semantic interface and saturated by a matrix clause DP. This semantic or *predicational approach* to control was advocated mainly by Chierchia (1983, 1984a,b, 1989, 1990)¹⁸ in response to a purely syntactic approach to control. The main idea underlying Chierchia's predicational approach is that obligatory control infinitivals are properties rather than propositions. Control relations are entailment relations that are made explicit as part of the meaning of the selecting predicate, and the subject is introduced later on in the context with the addition of meaning postulates like $[\]-j$ (a context dependent modal operator), as shown in (34) and paraphrased in (35).

(34) try' (P) (x) \rightarrow $[\]-j$ P(x)

(35) whenever x tries to bring about P, then in all contextually relevant situations (namely those where what x tries actually succeeds) x does P.¹⁹

The *predicational* approach to control is particularly helpful for Agree-based analyses of LDA. Both Boeckx and Bhatt correlate the presence of LDA with the absence of PRO-subjects in infinitivals selected by restructuring predicates. Interestingly however, while they vouch for the *predicational* approach for restructuring predicates, they also adopt a different, *propositional* approach to control for non-restructuring predicates. Under this approach, non-restructuring predicates select larger-than-VP phrases (vP and IP/CP) that license external arguments or embedded PRO-subjects (also see Chomsky 1980, 1981;

¹⁸ Also see Williams (1980), Dowty (1985), Lebeaux (1985) and Clark (1990).

¹⁹ Also see Lasnik and Fiengo (1974) for a similar analysis of obligatory control.

Koster and May 1982; Manzini 1983; Bouchard 1984; Koster 1984, Borer 1989; Petter 1998; Toth 2000; Landau 1999, 2000). PRO plays a crucial role in blocking cross-clausal agreement in non-LDA constructions. The restructuring/non-restructuring distinction is therefore very crucial for both authors and their respective accounts for LDA, that I elaborate below, are grounded in the theory of restructuring.

2.3.1 Boeckx's Multiple Agree Analysis

As mentioned above, Boeckx (2004) extends the 'lexical' restructuring framework of Wurmbrand (2001) to Hindi-Urdu LDA constructions. Restructuring predicates like *want* select bare VP complements that fail to realize their external arguments. Schematically (36):

(36) [V-2 [_{VP-1} V-1 DO]]

Following standard assumptions that structural case is checked against functional heads v/T, Boeckx then contends that Hindi-Urdu infinitivals fail to check case on their objects, forcing a long-distance probe-goal relation between the embedded argument (DO) and matrix v, as shown in (37). As a consequence, object agreement is manifested on the higher verb without actual object movement.

(37) [v [V-2 [_{VP-1} V-1 DO]]]

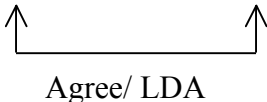

Agree/ LDA

Boeckx then appeals to a slightly revised version of Agree, dubbed ‘Multiple Agree’ (38) to explain the obligatory presence of agreement morphology on the embedded verb in LDA constructions.

(38) MULTIPLE Agree (multiple feature checking) with a single probe is a single simultaneous syntactic operation; Agree applies to all the matched goals at the same derivational point *derivationally, simultaneously*. (Hiraiwa 2001: 69)

The mechanism of Multiple Agree allows the matrix verb in LDA constructions to agree simultaneously with the infinitive and the embedded object. This is shown in (39).²⁰

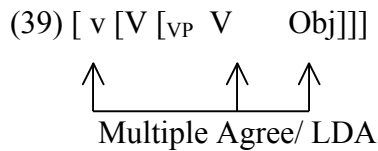

Boeckx (2004:33) “speculates here that the infinitival verb in Hindi manifests agreement overtly because it is gerundive in character (thus [it is] more nominal than a straight infinitive...)”. Under this approach, a matrix verb in LDA structures ends up agreeing simultaneously with two goals: one a real nominal and the other, a nominal like item. The infinitive then ends up receiving the phi-value of the object indirectly via some mechanism like feature transitivity.

²⁰ See Hiraiwa (2005) for yet another Multiple Agree based account of LDA.

It is important to note here that it is not at all obvious that Hindi-Urdu infinitives are actually “gerundive” in character. Bhatt (2005) criticizes a similar claim made by Butt (1995), based on one crucial difference between infinitives and gerunds. He notes that while Hindi-Urdu gerunds and infinitives are morphologically similar, they differ in licensing genitive subjects. Consider:

(40) ?Firozne shabnamkaa roTii khaanaa chaahaa

Firoz-erg. Shabnam-gen. bread-acc. eat-def. want-def-perf.

‘Firoz wanted Shabnam to eat bread’

(41) *Firoz-ne [Shabnam-kaa/kii rotii khaa-nii] chaah-ii.

Firoz-erg Shabnam-gen. bread-acc.sg.fem. eat-inf.sg.fem. want.sg.fem.perf.

‘Firoz wanted Shabnam to eat bread’

While sentences like (40) – which for Bhatt involve gerunds like *khaanaa*– host a genitive subject (*Shabnam*), this is impossible in structures involving infinitivals (41). Infelicitous LDA sentences with genitive subjects provide strong support to the claim that long-distance agreement can only take place across restructuring predicates selecting infinitivals. Non-LDA structures on the other hand may involve gerunds. Evidently there is some dialectal variation among speakers in this regard. (40) for instance was judged infelicitous by all my informants, which may be taken to indicate that at least for some speakers of Hindi-Urdu, absence of LDA does not necessarily coincide with the presence of gerunds. Dialectal variation notwithstanding, Bhatt’s observation about the syntactic difference between gerunds and infinitives is definitely on the right track. The alleged

contrast however needs to be substantiated with better examples. Consider in this respect (42) and (43), two sentences hosting genitive subjects inside embedded gerunds and judged as perfect by all my informants. (42) is especially interesting as the gerundive ‘verb’ is also morphologically distinct (from an infinitive) due the presence of a genitive case marker *ki* on it.

(42) Peterko [Paulke India chale jaane ki] chintaa thii.

Peter-dat. Paul-gen. India go-gerund-gen. worry be-past

‘Peter worried about Paul’s moving to India’

(43) Johnko [Maryka bacco par dhyaan denaa] zyaadaa pasand he.

John-dat Mary-gen children on care-give more like be-prst.

‘John prefers Mary taking care of the children’

In light of this discussion, an alleged parallelism between gerunds and infinitives appears highly unlikely. Moreover, note that if infinitives are not gerunds (and hence do not count as goals)²¹, we are back to square one on the issue of embedded verb agreement in LDA sentences. Since these predicates do not count as goals (or nominal-like), the matrix probe cannot simultaneously, Multiple Agree with it and the lower nominal. This leaves the issue of parasitic agreement in Hindi-Urdu without an explanation.

²¹ By its standard definition, a ‘goal’ is a nominal with phi-values that it may attribute to a head with unvalued features under a probe-goal relation. In a Multiple Agree system like that envisaged by Boeckx, the relation must hold between a probe and two goals (with nominal/nominal-like features). Therefore once it turns out that one of the alleged ‘goals’ does not approximate a nominal, it is hard to see how we can still maintain a probe-goal relation between it and the matrix head.

On the issue of optional object agreement, Boeckx claims that it results from selecting non-restructuring verbs that are subcategorized for CP/TP clauses with an obligatory PRO-subject. PRO restricts matrix *v*'s search space, disallowing it to agree with the object stranded inside the embedded VP (as shown in (44)). In the absence of appropriate goals that may assign the probe a value for its phi-set, the matrix verb is subsequently forced to take default agreement morphology. The embedded object in turn receives structural accusative from the lower *v*.²²

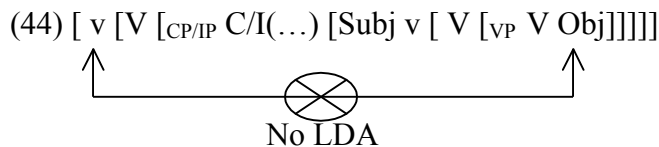

This account is also not without its problems. Since the object in non-LDA structures checks structural accusative case against embedded *v*, we predict (given standard assumptions about case and phi-feature-correlation) that the embedded verb obligatorily bears overt object agreement independently of matrix clause agreement. In more concrete terms, we predict the successful generation of structures like (45) in Hindi-Urdu. Obviously, the prediction is not borne out, as evidenced by the unacceptability of the following sentence.²³

²² Boeckx adopts Chomsky's (2000) notion of Defective Intervention to explain optional LDA. This issue is taken up in detail in chapter 4.

²³ Boeckx attempts an explanation by once again appealing to the mechanism of simultaneous agreement, contending that "...a multiple Agree analysis explains why, if no LDA takes place, no agreement with the infinitive will take place, as the latter does not take place independently of the former" (Boeckx, 2004:33). However, this still does not explain why the embedded verb (which is non-defective, non-gerundive in (45)) cannot independently agree in phi-features with the object (whose structural case it values) in the absence of LDA or why infinitival agreement must always be indirect and accomplished via Multiple Agree.

(45) *Johnne roTii khaanii chaahaa.

John-erg. bread-acc.fem. eat-inf.fem. want.def.perf.

‘John wanted to eat bread’

2.3.2 Bhatt’s AGREE system

Bhatt’s (2005) analysis for Hindi-Urdu LDA is also grounded in the lexical restructuring framework of Wurmbrand (2001). However, in his system, infinitivals are at least vPs (46), and therefore constitute a conducive environment for structural accusative case-checking for embedded objects. More precisely, since these infinitivals have a functional v layer, objects are case-checked internal to the embedded clause but remain active for clause external computations. Bhatt then contends that it is AGREE (47) and not Agree that underlies phi-checking in narrow syntax.

(46) [IP Inf [_{VP} v [_{VP} V OBJ]]]

(47) AGREE is a ‘process by which a head X with unvalued uninterpretable features (the Probe) identifies the closest Y /YP in its c-command domain with the relevant set of visible matching (i.e. non-distinct) interpretable features (the Goal), and uses the interpretable features of Y /YP to value its uninterpretable features.

By (47), an item must have a non-distinct set of features in order to be counted as a goal for a probe. Under this approach, structural case has no role in determining whether a goal is active or not for phi-computations. Bhatt then gives independent evidence substantiating his claim. He presents data corroborating first, that functional verbal heads

in Hindi-Urdu are active case-checkers even in cases that are canonically assumed to lack structural accusative (e.g. passives) and second, accusative case-marked DPs are still active for phi-relations with higher heads. Consider the following sentences in this regard:

(48) Sita-ko raam-dwara daantaa gayaa.

Sita-acc Ram-by scold.def. passive.def.

‘Sita was scolded by Ram’

(49) Ram Sitako daantaa.

Ram-nom. Sita-acc. scold-def.

‘Ram scolded Sita’

As illustrated above, the subject of the passive (48) allegedly carries the same accusative case-value (the *ko* morpheme) as the object of the active sentence (49). This similarity is, according to Bhatt, a strong indication that objects are case-valued by a functional verbal head in Hindi-Urdu passives, which they retain when they target the surface subject position (namely the specifier of TP). Case-valuation by *v* does not automatically make them inactive for the features on T, contra what the Activation Condition dictates. The phenomenon of case-retention is also taken to argue that Hindi-Urdu constitutes an exception to Burzio’s Generalization. Verbal heads in passives cannot license theta-roles for external arguments, but that does not affect their case-checking property. Bhatt extends these idiosyncrasies of the language - pertaining to (i) the presence of functional case-checking *v* in passives, (ii) active case-marked DPs participating in phi-checking

with higher heads and (iii) the alleged disconnection between case-valuation and external theta-role assignment - to lexical restructuring infinitivals. He contends that restructuring infinitivals involve functional verbal heads that are eligible accusative case-checkers though they are incapable of assigning external theta-roles. Secondly, accusative case-marked objects in restructuring infinitivals remain active for phi-agreement with higher heads. As further evidence for his claims about the underlying structure for lexical restructuring predicates, Bhatt presents cases of Hindi-Urdu long passives like (50).

(50) sita-ko mujhe/*me piit-ne di-yaa ga-yaa

Sita-dat. me-acc/I.nom hit-inf.obl give-pfv.msg. pass-pfv.m.sg.

‘Sita was allowed to hit me’ (=‘Someone let Sita hit me’)

As also observed with simple passives like (48), objects in Hindi-Urdu long passives also cannot be valued as nominative when the higher verb is passivized (50); instead they must bear an obligatory accusative marker (*-ko*). Given that this sentence has a matrix *v* that is passivized, structural accusative seems to be checked internal to the infinitival, with the case-value retained by the object when it undergoes movement to the specifier of TP.

However on closer investigation, we find ample evidence to argue Bhatt’s claims. As for instance, as already pointed out (see footnote 7), *ko* encodes specificity and is obligatory on dative subjects and pronominal and referential objects. This makes it very difficult to gauge the exact role of the morpheme for passive surface subjects and restructuring

objects. Whether *ko* is the accusative case-morpheme in these constructions cannot be therefore said with much certainty. Moreover, while it is true that raised objects in passives carry the morpheme (51)-(52), it is by no means obligatory, as we can see in sentences (54) to (55). Importantly, when the raised object appears without the morpheme in passives, it obligatorily triggers person, number and gender agreement just like any other nominative subject (and unlike other accusative objects that trigger only gender agreement). In light of the fact that *ko* is non-obligatory for passive subjects as well as the morpheme's multi-functional roles, Bhatt's claims about Hindi-Urdu passives and lexical restructuring infinitivals remain largely unmotivated. Instead I will claim that passive verbs are not eligible accusative case-checkers in Hindi-Urdu and that underlying objects are forced to move to the specifier of TP for case. They subsequently trigger full phi-feature agreement on T and are also interpreted as specific. The morpheme *ko* in (51) and (52) on the other hand marks specificity. Under such circumstances, subject-verb agreement fails to get morphologically realized.

(51) Mujhe/*ko* bhej diyaa-gayaa he.

I-fem send give-go-def. be-def-prst..

'I have been sent away'

(52) mezko bhec diyaa-gayaa he.

table-fem. sell give-go-def. be-def.prst.

'The table has been sold'

(53) Me bhej di-gayii hu.

I-fem. send give-go-fem. be-1p.sg.

‘I have been sent away’

(54) tum bhej dii gayii ho.

You-fem. send. give-go-fem. be-2p.sg.prst.

‘You have been sent away’

(55) mez bhec di-gayii he.

Table-fem. sell give-go-fem. be-3sg.sg.prst.

‘The table has been sold’

The second problem with Bhatt’s account is that it predicts unaccusatives to pattern alike with passives and restructuring infinitivals. If as he claims, it is a general property in Hindi-Urdu that functional *v* assigns structural accusative even while it is unable to host an external argument, it is predicted that underlying objects in unaccusatives also get obligatory case-marked by *v* before they target the specifier of TP. The prediction is however not borne out. The presence of the morpheme on the subject often generates unacceptable results (56).²⁴ Subjects that are not overtly marked with *ko* trigger obligatory person, number and gender agreement like other nominative subjects (57)-(58).

²⁴ If we change the mood of the sentence, *ko* becomes obligatory for pronominal subjects, as shown in (i). Contrast (i) and (ii)-(iii). The latter set shows that no such condition is required of non-pronominal subjects.

(i) mujhko/*me yahaan roz aanaa paRtaa he.

I-fem here everyday come-inf. must be.

‘I am forced/obliged to come here everyday’

(ii) mezko roz saaf karnaa paRtaa he.

Table-fem everyday clean do-inf. must be

‘The table has to be dusted every day’

(iii) mez roz saaf karnii paRtii he.

Table-fem. everyday clean do-inf.fem. must-fem. be.

‘The table must be dusted everyday’

(56) *mujhko yahaan aataa/aatii rahtaa/rahtii he.

I-fem here come-def. cont-def. be-def.prst.

‘I come here frequently’

(57) me yahaan aatii rahtii hu.

I-fem. here come-sg.fem. cont.- sg.fem be-1p.sg-prst.

‘I come here frequently’

(58) tum yahaan aatii rahtii ho.

You-fem. here come-sg.fem. cont-sg.fem. be-2p.sg-prst.

‘You come here frequently’

Therefore once we involve unaccusatives in the picture, it becomes even less obvious that Hindi-Urdu differs from other languages in that its verbs (even in what are usually termed defective environments like passives and unaccusatives) must check structural accusative on their underlying objects. Case retention does not appear as general as Bhatt seems to be assuming. The next task is then to find out if structural accusative can be checked internal to lexical restructuring infinitivals. In this case too, the evidence that Bhatt provides from long passives is not very convincing. The obvious problem one finds with long passives like (50) is that they involve functional restructuring predicates (*let/give*), which as I have already pointed out has properties that are distinct from those of lexical restructuring predicates (see footnote 17). Since our concentration here is on LDA with lexical restructuring predicates, (50) cannot form the basis for understanding their underlying representations. Instead we should consider long passive constructions with

lexical restructuring verbs like (59), which is the passive counterpart of the LDA construction *I want-fem to eat-fem bread*.²⁵

(59) %roTii-(*ko) khaanii chaahii gayii thii.

Bread (*ko) eat-fem. want-fem. be-pass.fem. be-3p.sg.pst.

‘Bread was wanted to be eaten’ (lit. Someone wanted to eat bread)

As illustrated above, the underlying object surfaces at the sentence initial position bearing a morphologically null case. Marking it with the *ko* morpheme in fact results in unacceptability, which makes it difficult to determine just from the form of the raised object, whether it carries an accusative assigned by embedded *v* or a nominative assigned by matrix *T*. However note that if *-ko* is really the accusative case that Bhatt assumes it to be, then the absence of the morpheme in these sentences is proof that in long passives, the raised subject is not marked with this specific case. That said, unfortunately, there is no straightforward way of accounting for the actual nature of the case involved on the raised subjects. Since first and second pronominal subjects in these constructions appear with an obligatory *ko*-marker (60)-(61), we cannot use agreement as a diagnostic to determine the kind of case involved here.²⁶

²⁵ Thanks to Shiti Malhotra for the data. The % sign depicts dialectal variation, with some speakers rejecting both short and long passives with volitional predicates.

²⁶ These structures are worse without the *ko* marker (i), but that is a general phenomenon for all derived first and second person pronominal subjects in passives with volitional predicates (ii)-(iii).

(i) *me/tum dekhni chaahii gayii.

I/you see-inf.fem. want-fem. give-pass-def.

‘I/you were wanted to be seen’ (lit. Someone wanted to meet me/you)

(ii) mujhko/tumko dekhaa gayaa.

I/you see be-pass-def.

‘I/you were seen’ (lit. Someone saw me/you)

(60) ?mujhko dekhne chaahaa gayaa thaa.

I-fem. see-inf. want-def. give-pfv.def. pass-pfv.def.

‘I was wanted to be seen’ (lit. Someone wanted to see me’)

(61) ?tumko dekhne chaahaa gayaa thaa.

I-fem. see-inf. want-def. give-pfv.def. pass-pfv.def.

‘You were wanted to be seen’ (lit. Someone wanted to see you’)

In a nutshell, the evidence that Bhatt provides in support of his claim that Hindi-Urdu passives and infinitivals check structural accusative is at best inconclusive. Case-retention is a not general phenomenon in the language, even based on the presence of *ko* on derived subjects in passives. In addition, I have provided independent evidence suggesting that passive subjects pattern very closely with nominative subjects, which could be taken to indicate that the former are never case-checked by *v*, which forces them to seek a higher tense head for case and phi-agreement. I have also shown that long passives do not prove that structural accusative is assigned internal to restructuring infinitivals and then retained by the DP when it targets the specifier of matrix TP. Derived subjects in long passives are either not marked overtly for case at all, in which case, they trigger gender (along with 3person, singular) agreement, or host the specificity marker *ko* that fails to coincide with overt agreement morphology. Absence of full phi-feature agreement in long passives with first and second person pronominals makes it impossible to use them to determine the case on the raised object. Given the absence of

(iii) *me/tum dekhii gayii.
I-fem/you see-fem be-pass-fem.
‘I/you were seen’ (lit. Someone saw me/you)

any data on the contrary, I conclude that Bhatt wrongly assumes that structural accusative is checked inside infinitivals. The lack of structural (accusative) case inside infinitivals will form a crucial assumption for my analysis that I detail later. For the meantime, let me return to Bhatt's actual analysis for LDA sentences, with their proposed underlying representations sketched in (62). As shown below, *want* selects an embedded vP/InfP complement, which fails to realize a syntactically realized external (PRO) argument.

(62) [Subject [_{vP-2} v [V [Inf [_{vP-1} v[V OBJ]]]]]]

In Bhatt's account, case-valuation and phi-valuation are independent of each other. Case on the embedded object in LDA sentences is valued by the embedded functional v, phi-agreement is accomplished against matrix finite T. The relevant steps are shown in (63):²⁷

(63) T [uF] [Subj-Erg V [Inf [uF] ...v. OBJ[F]]]

The diagram illustrates three syntactic operations: 'Case-valuation' (represented by two upward arrows from v to OBJ), 'AGREE' (represented by an upward arrow from T to OBJ), and 'Co-valuation' (represented by a long horizontal line with an upward arrow from T to Inf).

There are three partially independent operations at play here: (i) accusative case-valuation on the embedded object by the lower verb, (ii) AGREE between the object and matrix T and (iii) 'co-valuation' for the feature-set on embedded Inf. The first, i.e. case-checking is accomplished (perhaps long-distance) when embedded v is introduced into the derivation. By AGREE, the case-marked object remains active for phi-valuation.

When matrix T is introduced into the derivation, it starts probing into its c-command

²⁷ For Bhatt, accusative Case to objects is assigned/valued by transitive v, ergative Case by Tense in association with transitive v and perfective aspect and nominative Case by other combinations of finite Tense, v and Aspect.

domain for a goal with the appropriate features to check its non-interpretable phi-set. The first item it encounters is Inf. that has an incomplete set of non-interpretable features. However since neither is already valued, direct phi-checking between them is rendered impossible by AGREE. T then enters into a kind of dependency with Inf and continues with its search until it finds the object that phi-values it. These phi-values, T passes onto Inf. via a process called ‘co-valuation’. This mechanism underlies overt morphological agreement in restructuring infinitivals; it enables heads such as Infs that cannot probe independently to receive phi-values indirectly.^{28,29} Absence of long-distance agreement on the other hand, for Bhatt, signals the presence of a larger than vP/IP (non-restructuring) infinitival. Embedded PRO subjects in these constructions forbid matrix T from looking past them to seek out embedded objects for phi-valuation.

We now have before us two different Agree-based approaches to Hindi-Urdu LDA. The first adopts a Multiple Agree mechanism to explain certain aspects of the problem whereas the other strictly prohibits case-marked nominals from becoming dormant for future phi-computations. The next section is devoted to some general problems with these accounts.

²⁸ Bhatt conjectures “that the phi-features of overtly case-marked NPs ...are not visible for the purposes of agreement” (pp. 20) in an attempt to explain why ergative subjects in LDA constructions fail to trigger agreement on matrix T.

²⁹ The process of co-valuation seems very specific to Hindi-Urdu. It cannot apply to languages like Itelmen where infinitivals fail to license overt agreement morphology even in LDA constructions.

2.3.3 Some general problems

Below I discuss three points on which these accounts can be contested. The first concerns the diagnostics or the constituency tests they use to locate agreement triggers in any given clause with LDA. I show that these tests are unsuitable for languages like Hindi-Urdu and hence cannot be considered as support for a long-distance agreement relation in LDA constructions. The last two problems concern some general theoretical assumptions underlying these studies, especially with regard to QR and control.

Bhatt (2005) provides evidence from movement and adverbial placement tests suggesting that agreement triggers don't move out of their base-generated infinitival clause positions. If true, this counts as a substantial piece of support for his claim that agreement between the embedded object and matrix head takes place long distance. Here, I take up two of the most relevant cases discussed by him.³⁰ The first case that Bhatt discusses involves structures like (64), where the agreement trigger apparently moves along with the rest of the embedded clause.³¹

(64) mujhe zaruur t-i aa-tii hai [saikil chala-nii]-i.

I-dat. definitely come-hab.fem. be.prs.3sg. bike ride-inf.fem.

³⁰ Boeckx (2004) also discusses some of these cases.

³¹ Bhatt's example involves a functional restructuring predicate, but the pattern can also be observed with lexical restructuring predicates. Consider (i).

(i) ?Johnne zaruur chaahii [roTii khaanii]
John-erg. definitely want-fem-perf. bread-fem. eat-inf.fem.
'John certainly wanted to eat bread'

Once again as in (65), there is no linear adjacency requirement on the embedded subject and the infinitival verb, as seen in (ii).

(ii) roTii, Johnne zaruur [khaanii] chaahii.
Bread-fem. John-erg. definitely eat-inf.fem. want-fem.perf.
'John certainly wanted to eat bread'

‘I certainly know how to ride a bike’

(64) is however only *prima facie* support for Agree. As I demonstrate below with other examples, dislocation is not a very reliable diagnostic to structurally locate an element in Hindi-Urdu. Consider:

(65) saikal-i , mujhe zaruur [t-i t-j]-k aa-tii hai [chalaan-nii-j]-k, chaahē
bike I-dat. definitely come-hab.fem. be.prs.3sg. ride-inf.fem. even-though
kaar chalaan-nii aaye naa aaye.
car ride-inf.fem. come not come.

‘I certainly know how to ride a bike, though I may or may not know how to ride a scooter’

In (65), *bike* base-generates inside the infinitival complement [*bike ride*], and then moves out to a sentence initial position. The remnant VP [*bike-t ride*] right dislocates at a later point of the derivation. This sentence shows that embedded objects may surface outside the clause they base-generate. The contrast between (64) and (65) also casts doubt on the validity of constituency tests for free word order languages like Hindi-Urdu. Sentences like (64) do not serve as sufficient ground for positing Agree for LDA in the language.³²

Extra evidence for a long distance agreement relation, Bhatt claims, comes from ‘adverbial placement’ tests. As shown in (66), embedded objects in LDA structures

³² For (64), assuming that agreeing objects undergo overt movement to a matrix clause position, I contend that a copy of the object inside the infinitival is spelled out at PF.

follow adverbs modifying the embedded clause (with the interpretation *Rohan desires to work hard again*). For this reading to be true, it is necessary that Rohan must have worked hard in the past. Assuming that such adverbs are adjoined to embedded vP, sentences like (66) are taken to indicate that the object hasn't moved out of the lower clause.

(66) Rohanne [phirse mehnat karnii] chaahii.

Rohan-erg again hard work-fem. do-inf.fem. want-fem.sg.perf.

'Rohan wanted to work hard again'

Interestingly however, Bhatt fails to take note of the fact that this sentence has a second reading where the adverbial modifies the higher predicate (i.e. is adjoined to the main clause vP). This is where we refer to Rohan's repeated desires or cravings to work hard. For this reading to be true, it is insignificant whether Rohan has ever worked hard in the past, though he definitely must have entertained similar desires (to work hard) before. If so, then just as with movement tests, the adverbial placement test seems irrelevant in the context of Hindi-Urdu LDA. The same sentence may have two different interpretations, indicating two different positions for the adverb. Hence the only conclusion one may draw from these sentences is that the agreeing DP may surface either within the lower vP or within the matrix vP.³³ There is no way to argue that the DP never appears in a main-clause position, based on structures like (66). In this regard, it is also relevant to take into

³³ Once again, if the object undergoes overt movement to a main-clause position (as I will eventually argue), then (67) with the lower reading for the adverbial can be derived only by spelling out the copy inside the infinitival. Or we can assume with Bobaljik (2002) that the adverbial is displaced at PF, i.e. it is pronounced in a position higher than the lower vP or IP to which it was adjoined in narrow syntax. In that case, the raised object is pronounced in the specifier of higher vP, with the adverbial still preceding it.

consideration structures like (67), where the agreeing nominal precedes a high adverbial like *probably*. These cases further substantiate the claim that embedded DPs can freely move beyond their base-generated clauses.

- (67) Rohanne roTii shaayad kal khaanii chaahii
 Rohan-erg bread-acc.sg.fem. probably yesterday eat-inf.fem. want.sg.fem.
 thii.
 be.fem.sg.perf.
 ‘Rohan probably wanted to eat bread yesterday’

To summarize, word order and adverbial placement tests do not serve as relevant diagnostics for Hindi-Urdu. Surface orders could be derived from either left or right dislocation or scrambling, an option very widely permitted in the language (see Mahajan 1990; Kidwai 2000). A second point of contention concerns the manner in which these theories treat scope construal in LDA constructions. As has been convincingly demonstrated by a number of authors (Davison 1988; Mahajan 1989; Bhatt 2005; among others), agreeing DPs take wide scope over matrix volitional predicates, unlike their non-agreeing counterparts.³⁴ This is illustrated in (68) and (69), taken from Bhatt (2005).

³⁴ Agreeing objects are also often interpreted as specific in direct contrast to non-agreeing objects that are obligatorily non-specific or generic. This is shown by the contrast in (i) and (ii).

- (i) Usne kursii toRnii chaah-ii.
 He-erg. chair-acc.sg.fem. break-inf.sg.fem. want.sg.fem.perf
 ‘He wanted to break the chair’
 (ii) Usne kursii toRnaa chaah-aa.
 He-erg. chair-acc.sg.fem. break-inf.def. want.def.perf
 ‘He wanted to break chair’

(68) Naimne har kitaab parhnii chaah-ii.

Naim-erg. every book-acc.sg.fem. read-inf.sg.fem. want.sg.fem.perf.

‘Naim wanted to read every book’

Want > every book

Every book > want

(69) Naimne har kitaab parhnaa chaah-aa.

Naim-erg. every book-acc.sg.fem. read-inf.def. want.def.perf.

‘Naim wanted to read every book’

Want > every book

*Every book > want

The LDA sentence in (68) has two interpretations. The first reading has *every book* scoping under *want*, i.e., it expresses Naim’s desire to read every book. In the second reading, *every book* scopes over *want*. This is the reading “where Naim does not have the express desire to read every book (in the library) - it is just that for every book in the library he has expressed his desire to read it. For this reading he need not know that he has in fact exhausted the books in the relevant set” (Bhatt: 34). The non-LDA sentence in (69) ends up with an obligatory narrow scope for the embedded object.

Assuming a standard QR approach to these cases, the object in (68) must raise as far as matrix vP to scope over the volitional predicate. (69) on the other hand must prohibit its object from raising to a position from where it can c-command the matrix verb. The problem with a QR approach is that it fails to explain the LDA/non-LDA scope contrasts.

While QR suffices to get wide scope for agreeing DPs in LDA constructions, there is no straightforward explanation for the narrow scope of non-agreeing objects. More concretely, there is no principled explanation in a QR-based approach to scope, as to why agreeing DPs could quantifier-raise to scope over matrix predicates (i.e. adjoin to matrix vP), though the same option is never made available for non-agreeing nominals. Bhatt (2005) attempts to answer this question, but as we will soon discover, the solution raises several new problems.

Bhatt’s solution is (broadly) based on Fox’s (2000) principle of Scope Economy.³⁵ For Fox, scope-shifting operations (SSOs) are restricted by economy considerations, which select the ‘optimal’ derivation from among a set of ‘interpretatively similar’ derivations (termed as a “reference set”). An optimal derivation is one that is constructed by eliminating instances of movement or by minimizing their length. A longer/‘non-economical’ SSO is blocked by a shorter/‘more economical’ SSO in the same reference set. The following examples from Fox help illustrate this point.

(70) A boy loves every girl. (Ambiguous)

³⁵ Fox’s account centers around English VP-ellipsis constructions like (ii) which are known to disambiguate structures like (i).

- (i) Some boy loves every girl. (Ambiguous)
- (ii) Some boy loves every girl and John does too. (Unambiguous).
- (iii) Some boy loves every teacher and some girl does too. (Ambiguous)

To account for (ii) along with the ambiguous (iii), Fox formulates the ‘Ellipsis Scope Generalization’ in (iv),

(iv) *Ellipsis Scope Generalization*

The relative scope of two quantifiers, one of which is in an antecedent VP of an ellipsis construction, may differ from the surface c-command relation, only if the parallel difference will have semantic effects in the elided VP.

Movement in the second conjunct is allowed only if it generates a distinct semantic interpretation. Parallelism requirements demand that the first conjunct has exactly the same set of operations. See below for some more discussion on Fox’s QR theory.

(71) John loves every girl.

(Unambiguous)

Sentence (70) is ambiguous; it allows both surface and inverse scope readings for its arguments.³⁶ The ambiguity arises from moving the object either to vP (72) or to TP (73). These potential derivations generate different semantics and are not mutually exclusive. The object takes narrow scope in the first (with the meaning that *there is a particular boy who loves every girl*), while in the latter, it scopes over the subject (with the interpretation that *for every girl, there is a (possibly different) boy who loves her*). (72) and (73) are not members of the same reference set and hence are not comparable with each other. Both SSOs may therefore apply to (70).

(72) [IP A boy-1 [vP every girl-2 [vP t-1 loves t-2]]].

(73) [IP every girl-2 [IP a boy-1 [vP t-1 loves t-2]]].

The second sentence (71) also has two ‘possible’ derivations. The first is where the object adjoins to vP (74) and the second, where adjunction is to IP (75). However in this case, both derivations result in the same interpretation: *John loves every girl*. This makes them competing derivations in the same reference set. Economy considerations choose the shorter ‘more optimal’ (74). Object QR to IP is therefore ruled out for (71).

(74) [IP John-1 [vP every girl-2 [vP t-1 loves t-2]]].

(75) *[IP every girl-2 [vP John-1 [vP t-1 loves t-2]]].

³⁶ Howard Lasnik (personal communication) draws my attention to some dialectal variation with regard to ambiguous scope in (70). Some speakers evidently do not get the inverse scope reading.

Fox's theory of QR is couched in terms of the Minimal Link Condition (MLC) that prohibits superfluous movement links. QR is obligatory for all quantificational DPs, with subjects and objects (obligatorily) targeting TP and vP respectively.³⁷ However MLC prohibits quantificational objects from targeting a vP-external position, unless the movement is necessary for interpretative purposes. Object adjunction to TP for instance is allowed only when it generates a new interpretation.

Bhatt (broadly) adopts Fox's MLC approach of QR to explain the scope patterns in Hindi-Urdu. The explanation for objects with wide scope in LDA constructions is rather straightforward. Object adjunction to matrix vP generates a new interpretation (namely wide scope for the object), and hence this step is not subject to the MLC. Schematically (76):³⁸

(76) [Subject [vP [VP [IP [vP [VP OBJ V]]]]]]

The account becomes slightly murky when it comes to explaining the absence of wide scope for objects in non-LDA structures. At this point, the semantic novelty of the specific step to be undertaken does not matter any more. What matters instead is the semantic novelty of an intermediate step leading to the final target. Here is how this revised version to Fox's theory works for non-LDA structures.

³⁷ Obligatory subject QR to TP is not depicted in the diagrams here.

³⁸ I am assuming that object adjunction to embedded vP is obligatory for Bhatt too.

Recall that complements of non-restructuring predicates are alleged CP/IP clauses capable of licensing PRO-arguments. Bhatt claims that the presence of PRO has a major role in ruling out QR in non-LDA constructions. Object-adjunction to matrix vP must proceed through intermediate IP which also hosts the PRO-subject. However this specific step fails to generate any obvious interpretative difference, as the raised object simply c-commands a null category. Therefore MLC not only rules out object adjunction to IP but also prohibits adjunction to the matrix vP (77).

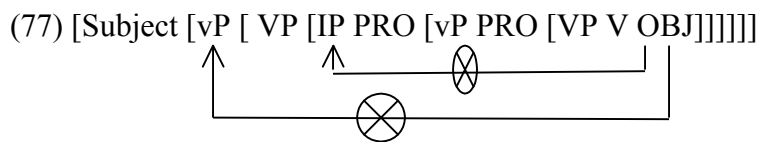

The main idea behind this revised MLC approach to QR is that an SSO with semantically vacuous intermediate steps is more expensive than one without them. An SSO with the object crossing over an intervening PRO involves a semantically vacuous step and consequently is more expensive than a derivation without a PRO.³⁹ Notice that to achieve the alleged difference between (76) and (77), it is no longer enough to just allude to Fox's Scope Economy Principle. For Fox, quantificational elements obligatory adjoin either to vP or IP, depending on their grammatical status as subjects and objects. Object adjunction to TP is however constrained by MLC, but only in comparison with cheaper but semantically non-distinct derivations. However Fox's theory imposes no prohibition on quantificational nominals moving over intervening elements like PRO, trace etc, as

³⁹ Bhatt overlooks the fact that the structure (77) has a PRO-trace in the specifier of embedded vP. In that case, the restriction on object QR must take place at the (lower) vP level, rather than at the (lower) IP level.

long as that movement is necessary to get the desired interpretation (over a DP placed higher in the tree). Bhatt, on the other hand, assumes that all steps leading to a semantic output count towards the cost of a derivation. Moreover, all intermediate adjunctions must also be semantically non-vacuous. If adjunction to embedded vP fails to produce a different interpretation, further DP movement is also prohibited. Empirically too, Bhatt's modifications are incompatible with the original conception of Scope Economy Principle, as they fail to explain even the simplest of scope variations that Fox was targeting. Take for instance, the quantifier-raising option (71)/(78) of the ambiguous English sentence (70).

(78) [IP every girl-2 [IP a boy-1 [every girl-2 [vP t-1 loves every girl-2]]]].

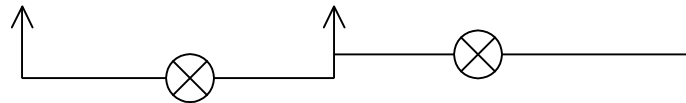

If Bhatt's revisions are taken into consideration, the object cannot move to TP over the intervening subject trace in the specifier of vP in (78). This step is semantically vacuous and given the modified MLC approach to QR, object adjunction to vP as well as to TP must be (incorrectly) ruled out. Other than that, Bhatt's system also leads toward semantic overgeneralizations. Consider his underlying representation for LDA structures again:

(79) [TP Obj [IP Subject [vP Obj [VP [IP [vP [VP Obj V]]]]]]]]



The object in (79) adjoins to matrix vP generating a new interpretation. By Bhatt's own assumptions, the object may then QR further and adjoin to matrix TP, taking wide scope over the quantificational matrix subject. Interestingly however, ergative subject constructions permit only surface scope interpretations between the matrix subject and the embedded object. Sentence (80) is just such an instance of scope rigidity, its only interpretation being that *there is some (specific) poet who wanted to recite every poem*.

(80) kisi shaayarne [har ghazal paRhni] chaahii.

Some poet-erg. every poem-acc.sg.fem. read-inf.sg.fem. want.sg.fem.perf.

'Some poet wanted to recite every poem'

It is also important to note that Bhatt's use of the term SSO is different from its usual connotation. Though Bhatt himself suggests that his modified MLC account uses SSOs, it is not apparent that they are used for comparing semantically analogous derivations. There is no basis for comparing SSOs in his study as LDA and non-LDA constructions are built around different numerations, one involving a restructuring predicate and its VP-complement and the other with a non-restructuring predicate and its CP/IP complement. Assuming that SSOs concern derivations that are built around the same numeration, nothing in Bhatt's account allows comparison between LDA and non-LDA derivations. The presence of QR in one cannot influence its absence in the other.

The final issue to tackle here is the use of dual control mechanisms to explain optionality in cross-clausal agreement. Agree-based analyses for LDA, as we have already seen must

endorse both *predicational* and *propositional* approaches to control or else they fail to account for the optionality of the phenomenon. Prima facie, the duality of control mechanism appears necessary to differentiate restructuring from non-restructuring predicates. Only in the latter is PRO syntactically realized, which explains the clause-bounded nature of their complement clauses. Nonetheless, despite their apparent success, the existence of dual control-mechanisms can be questioned on the following grounds. First, as I articulate in chapter 1, the research principle in minimalism is that any mechanism beyond what is absolutely necessary for computations must find a principled explanation either in terms of the properties of the interface systems or from general considerations of computational efficiency. As it turns out, having two mechanisms for the same phenomenon might not always be computationally efficient. So let us restrict our attention to the first factor. Could this duality of control be imposed on the grammar for legibility requirements? Can the syntactic or the semantic realization of PRO make a significant difference at the semantic interface? At the interfaces, complements without PRO-subjects must be saturated, just like their propositional counterparts. They (probably) end up receiving very similar (if not identical) LF-representations. If that is true, it is not immediately obvious what requirements of the interfaces are not met if the computational system fails to incorporate both types of control mechanisms. Neither do we find any observable difference in the syntactic and semantic behavior of restructuring and non-restructuring verbs. This is illustrated by the following sentences.⁴⁰

⁴⁰ Obligatory control also cannot have split antecedents as shown in the English example in (i);
(i) *John-i told Mary-j to PRO-i+j leave together.
LDA is impossible with predicates like *ask/tell*. Hence I am unable to use this particular diagnostic here.

- (81) Johnne-i socaa ki Maryne-j apnii-j/*i kitaab paRhonii
 John-erg think.def. that Mary-erg self's book-acc.fem.sg. read-inf.fem.sg.
 chaahii.
 want.fem.sg.perf.
 'John thought that Mary wanted to read her/*his book'
- (82) Johnne-i socaa ki Maryne-j apnii-j/*i kitaab paRhnaa
 chaahaa.
 John-erg think.def. that Mary-erg self's book-acc.fem.sg. read-inf..def..
 want.def.perf.
 'John thought that Mary wanted to read her/*his book'
- (83) [Johnki-i maa-ne]-j apnii-j/*i kitaab paRhonii chaahii.
 [John-gen mother]-erg. self's book-acc.sg.fem. read-inf.sg.fem. want.sg.fem.perf.
 'John's mother wants to read her/*his book'
- (84) [Johnki-i maa-ne]-j apnii-j/*i kitaab paRhna chaahaa.
 [John-gen mother]-erg. self's book-acc.sg.fem. read-inf.def. want.def.perf.
 'John's mother wants to read her/*his book'
- (85) abhaagene roTii khaanii chaahii.
 Unfortunate-erg. bread-acc.sg.fem. eat-inf.sg.fem. want.sg.fem.perf.
 'The unfortunate wanted to eat bread'
- (86) abhaagene roTii khaana chaahaa.
 Unfortunate-erg. bread-acc.sg.fem. eat-inf.def. want.def.perf.
 'The unfortunate wanted to eat bread'
- (87) Johnne roTii khaanii chaahii aur Billne bhii.

John-erg bread-acc.sg.fem. eat-inf.sg.fem. want.sg.fem.perf. and Bill-erg also.

‘John wanted to eat bread and Bill too (wanted Bill to eat bread)’

(88) Johnne roTii khaanaa chaahaa aur Billne bhii.

John-erg bread-acc.sg.fem. eat-inf.def. want.def.perf. and Bill-erg also.

‘John wanted to eat bread and Bill too (wanted Bill to eat bread)’

The above sentences show restructuring and non-restructuring predicates patterning identically with regard to all properties typically associated with obligatory control (cf. Williams 1980, Hornstein 1999, 2001). OC PRO in both has a local antecedent (81)-(82) that must occur in a c-commanding position (83)-(84). PRO gets a ‘de se’ interpretation in both (85) and (86): *the unfortunate wants that he himself eat the bread* and also receives a sloppy reading under VP-ellipsis (87)-(88). Given these similarities between restructuring and non-restructuring sentences, it is difficult to determine what specific syntactic and semantic roles each specific approach to control is assigned to play in the grammar. More importantly, given that there are no observable legibility demands that they must separately meet, it is questionable that both *predicational* and *propositional* approaches to control must be simultaneously endorsed within the theory of grammar.

At any rate, it is interesting, perhaps necessary to also see if this ‘descriptive’ technology embraced to explain optionality in agreement can be eliminated, without actually compromising on the empirical results. I take up this task in the next section.

2.4 Towards An Alternative

The main idea advocated here is that agreement is always very local. In LDA constructions, the embedded object must be a sister to the matrix head in order to agree with it. Long distance agreement in Hindi-Urdu is therefore only illusory. The object in fact moves to the matrix clause to trigger matrix verbal agreement, as shown below in (89).

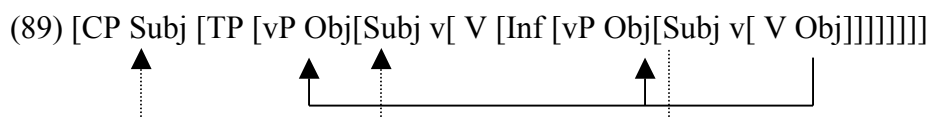

The representation in (89) also shows the embedded subject moving to the matrix subject position, which I will assume is the specifier of CP. This relates to the second core aspect of my work. I assume along with Hornstein (1999, 2001) that (obligatory) control is a relationship between a moved element and its copy/trace, i.e. a controllee is a copy of the controller. Take the control sentence in (90) for illustration. Under standard control accounts with PRO, (90) has the underlying representation in (91), where the antecedent *John* base-generates in the matrix clause position and controls the embedded PRO subject. Under the control-as-movement account on the other hand, I assume as in (92), that the matrix subject starts off as the external argument of the embedded clause and then targets a matrix clause position.

(90) John hopes to see Mary someday.

(91) John hopes [PRO to see Mary someday].

(92) John-1 [vP John-2 hopes [TP John-3 to [John-4 see Mary someday]]].⁴¹

John in (92) moves to the matrix subject position, via the specifiers of embedded TP and matrix vP. The chain <John-1, John-2, John-3, John-4> involves two theta positions (the specifiers of the embedded and matrix vPs) but one case position (the specifier of matrix TP). In what follows, I adopt the movement approach to control for my analysis of LDA with restructuring predicates like *want*. This decision is partly motivated for methodological reasons and partly for technical reasons. On the methodological level, I would like to see if the dual control mechanism that has been adopted for LDA can be substituted by the movement approach to control. If successful, it will help us argue against not only positing two different control mechanisms, but also against positing a separate module for control. The technical reason behind why I choose the movement alternative instead of choosing a PRO-subject is as follows. Observe for example, what happens when we posit embedded PRO-subjects for LDA structures as in (93).

(93) [CP Subj[TP [vP Obj[Subj v[Inf Obj [Inf PRO [vP Obj[PRO v[V Obj]]]]]]]]]]]

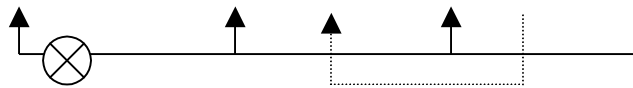

In (93), when PRO targets the specifier of Inf. for null case reasons (Chomsky and Lasnik (1991), the object must adjoin to Inf. (or moves to a second specifier) before it makes its next move to an A-position (for case-valuation and phi-checking) in the matrix clause. However, Inf's phi-set is already checked by PRO by the time the object targets its domain. Since the object does not check any features on Inf., this position counts simply

⁴¹ The indices are just for ease of exposition, and have no real significance here.

as an A-bar position. However once the object lands at this position, it is prohibited from targeting a higher A-position (namely the specifier of vP) by the ban on Improper Movement. This incorrectly rules out LDA in Hindi-Urdu.^{42,43}

2.4.1 LDA with defective v

Let me elaborate the alternative now, starting with some of its other core features. First, I contend that embedded v in LDA structures cannot license structural accusative to its object. This idea is diametrically opposed to Bhatt's claims about structural case-checking inside infinitivals. I have discussed at length various problems with Bhatt's observations, and do not intend to repeat them here. Instead I will emphasize on another property of Hindi-Urdu infinitivals that is equally relevant for my analysis. Consider:

⁴² Some core aspects of the alternative analysis that I presented above are also found in Mahajan (1990). While presenting a movement alternative, he contends that objects move overtly to the specifier of AgroP, generating object-verb agreement. However, there are some crucial respects in which the present analysis differs from his account. First, Mahajan is forced to adopt a mechanism of "PRO-invisibility" that allows object movement across intervening embedded subjects. This mechanism is restricted to restructuring predicates and is very similar to the *predicational* approach adopted for restructuring by Boeckx (2004) and Bhatt (2005). A second difference between my analysis and Mahajan's lies in the manner in which optionality is handled. Recall that object agreement is optional; the matrix verb may also carry default agreement. Mahajan attributes the absence of LDA to the presence of a case-assigning head AgroP in the embedded clause. Since the object is sometimes case-marked clause-internally, there is no motivation to obligatorily move it to the matrix clause. The problem with positing a structural case-assigner in the embedded clause is that it incorrectly predicts infinitival agreement in the absence of LDA (i).

(i) *Johnne roTii khaanii chaahaa.
John-erg. bread-acc.fem. eat-inf.fem. want.def.perf.
'John wanted to eat bread'

⁴³ Following May (1981), I assume that the ban on Improper Movement follows from Condition C of the binding theory. Copies of A-bar moved elements are mapped onto variables at LF, which must be A-free. Given this constraint, an item in narrow syntax can move through successive A-steps before finally targeting an A-bar site or it may move successive-cyclically through intermediary A-bar positions to its final A-bar site. But what it cannot do is move from an A-bar position to an A-position. That is, once it moves to an A-bar position, it must not target another A-position. Moving to an A-position would entail A-binding its copy in the A-bar position, leading to a Condition C violation. I leave the details of how these A-bar copies are interpreted as variables at LF for future research.

(94) [roTii khaanaa/*khaanii] sehat ke-liye achchaa he
 bread-fem. eat-inf-def/*fem. health for good be-prest.
 ‘It is healthy to eat bread’

It is a robust fact in Hindi-Urdu that infinitivals fail to independently host overt phi-object agreement morphology (94), which I take to imply that structural accusative is perennially absent from these structures. Structural case is valued as a consequence of complete phi-valuation and infinitives – by virtue of being defective functional heads – are incapable of licensing structural case. Extending the same observation to lexical restructuring infinitivals, I claim that they too lack a non-defective functional, verbal head to check accusative on their objects.⁴⁴ The second crucial feature of the alternative analysis is that DPs are considered inactive for phi-valuation once they are case-marked (in conformity with the Activation Condition). However every instance of phi-checking does not entail structural case-valuation. As already mentioned, a head must have a full set of phi-features to be able to value the case on a DP. If the head is defective with an incomplete set of phi-features, it can agree with a DP but this instance of phi-valuation will not result in case-valuation for the nominal. Therefore the DP will remain active for phi-computations even when it has previously valued the features on defective heads. What this means for LDA constructions is that the embedded object must be active with an unvalued structural case till it agrees with matrix v. It may however assign its value to intermediate, defective heads without receiving a case-value from them. With this, let us now focus on the actual steps leading to LDA (95).

⁴⁴ See section 2.2 for arguments that accusative objects in ergative subject constructions receive case from v, and not from T.

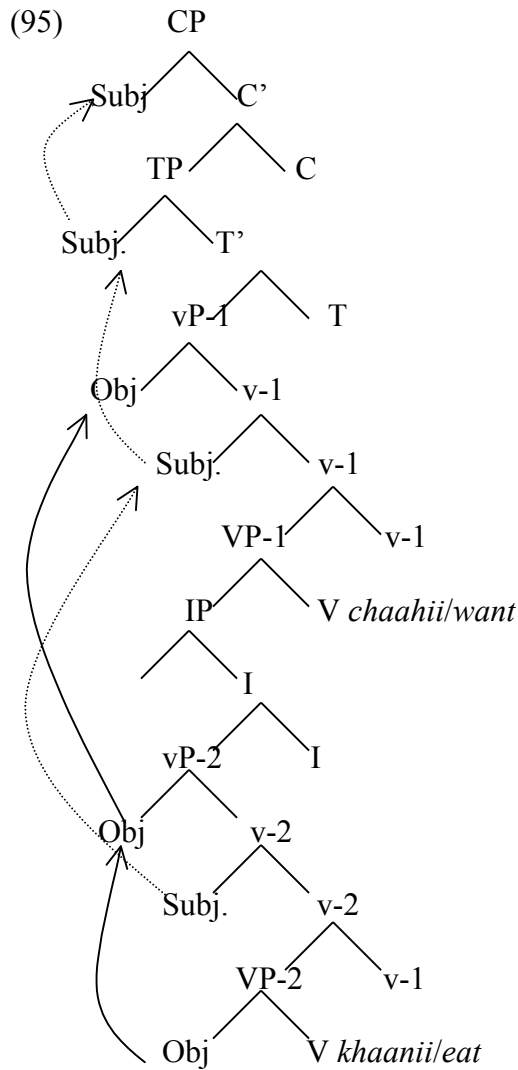

The matrix subject in (95) is first merged at the specifier of vP-2, where it receives the external theta-role of *eat*. It then moves further up to the specifier of vP-1, receiving a second theta role from *want*. vP-2 is defective and unable to check structural accusative on the embedded object, which forces the latter to target a higher verbal head for case-checking purposes. Object movement proceeds via the outer specifier of vP-2, resulting in phi-valuation for v-2's incomplete set of features. Notice that once the object targets a

vP-2 position, it lands in the same minimal domain as the subject. This makes them equidistant (Chomsky 1995) from all (higher) functional heads. Next, these nominals target matrix vP; the subject for a second theta-role and the object for a structural case value in return for values for v's complete set of phi-features. The subject continues on its journey to the specifier of CP through the specifier of TP either for EPP or if Davison (2004) is right, for its own structural case requirements.⁴⁵

Davison demonstrates that ergative case, unlike theta-related inherent case, does not correlate with any specific semantic role. Though generally associated with agents (96), ergative case is also found with experiencers (97).

(96) Maryne Johnko dandese pitaa

Mary-erg. John-acc. stick-with hit-past.

'Mary hit John with a stick'

(97) Maryne johnko dilo-jaanse chaahaa.

Mary-erg. John-acc. very love-past.

'Mary loved John wholeheartedly'

Based on this evidence, Davison rules out an inherent status for Hindi-Urdu ergative and instead elevates it to the status of a structural case at par with nominative or accusative. She corroborates this claim with data that reveals the dependence of ergative case on a specific kind of functional tense head. The evidence comes from counterfactuals or

⁴⁵ See Davison (2001) for evidence for the structurally higher position of ergative subjects.

irrealis conditionals that fail to license ergative subjects (98), in direct contrast to finite sentences like (99).

(98) *tumne mujhee bataate ki tumko meraa kahnaa buraa lagaa, to maiN kahnaa
you-erg. I-dat. tell-impf that you-dat my say-Inf bad strike, then I-Nom say-Inf
band kar detii
shut do give-impf.
'If you had told me that what I was saying annoyed you, then I would have
shut up.'

(99) tumne mujhee nahiin bataayaa.ki tumko meraa kahnaa buraa lagaa
you-erg I-dat/ not tell that you-dat. my say-inf. bad strike-past.
'You did not tell me that what I was saying annoyed you'.

I have already mentioned that the ergative-absolutive case system comes into effect with perfective aspect. At the descriptive level, the unacceptability of (98) is therefore not surprising. However, Davison raises the question of how to correlate this association in feature-checking terms. Her suggestion is that ergative is assigned to a DP's structural case in reflex of feature-valuation of a finite, perfective T. That explains why it is restricted to a certain kind of functional tense head, and fails to be licensed by others including non-finite and imperfective tense heads. If Davison is right, there is a structural case motivation for moving the subject of the LDA construction to the specifier of matrix TP. It then targets its final landing site in the specifier of CP.

There is another important EPP-related issue to tackle here. For my analysis to work, I must claim, contra Lasnik (2001) that embedded IP does not host an EPP feature and consequently does not count as an intermediate landing site for embedded DPs. If on the other hand, embedded Inf counts as a landing site for the arguments, we will have two instances of Improper Movement. Observe how. Since Inf's EPP has to be satisfied, the subject must move through the specifier of embedded IP to check it. Since this step places the subject in a structurally higher position, the object must also adjoin to IP in order to avoid minimality violations. This is an instance of A-bar movement and constraints on Improper Movement would disallow the object from targeting a higher A-position, incorrectly ruling out LDA. The same observation holds for the subject. If its movement to the specifier of embedded IP is just for EPP reasons, then it must count as movement to an A-bar position. All further A-movement is consequently disallowed.

There is one remaining question to address here. It has been an underlying assumption of this work that structural case is checked as a reflex of phi-agreement with non-defective heads. I have also assumed that nominals value the incomplete phi-set of defective heads, even when they fail to license their structural case. This was observed in the case of LDA structures, where the object checks the features on the embedded defective verb en route to the specifier of matrix vP. However, there must be a separate mechanism that facilitates the overt manifestation of object agreement in LDA infinitivals, since as mentioned earlier, Hindi-Urdu does not generally entertain this option. A tentative solution is to assume the existence of Tense-Dependency (achieved via T to T raising, in the sense of Roberts 1997) between the two clauses in LDA structures. Tense-

dependency is a phenomenon by which the event time of the lower predicate takes the event time of the higher predicate as its reference time. Therefore in a LDA sentence like (100), the event of *eating* is contingent on the event time of *want*; the former obligatory follows the latter.

(100) Johnne [roTii khaanii] chaah-ii.

John-erg. bread-acc.fem. eat-inf.fem. want.fem.perf.

‘John wanted to eat bread’

Tense dependency, I contend allows finite tense infiltration into the lower clause, which renders it possible to manifest overt object agreement on the infinitive. This process apparently is absent in infinitivals like (94), where overt agreement is also missing, as expected. Note that tense-dependency does not suffice for the PF realization of agreement inside infinitivals. In addition, it is also necessary that the object moves to the specifier of the embedded head and agrees with it at some point of the derivation. In situations where the object fails to locally value the features on the defective head, object agreement is impossible despite tense-dependency.⁴⁶

2.4.2 Predictions for Itelmen LDA

If my account for ‘parasitic’ infinitival agreement is right, it has an important implication for Itelmen LDA sentences: they must lack tense-dependency. That explains why

⁴⁶ Intermediate verbal heads are not possible interveners as they form a complex with the tense-head in Hindi-Urdu. This is attested by the phenomenon of agreement sharing between verbs and auxiliaries.

infinitival agreement never shows up even in the presence of matrix clause agreement in this language. The details are given below.

Bobaljik and Wurmbrand (2003, 2005) provide the following instances of Itelmen LDA (101)-(102). In both cases, the matrix verb bears the person and number morphology of the embedded direct object. Next, compare (102) with its non-LDA counterpart in (103). As is evident, the matrix verb must appear in an intransitive form when it fails to receive phi-values from the embedded object.^{47,48}

(101) t'-utu-z-in alcqu-al-il
1sg. SUBJ.-unable-pres.2sg.OBJ see-future-inf.
'I am unable to see you'

(102) na əntxa-βum=nin kma jeβna-s
he forget-1sg.obj=3.cl. me meet-inf.
'He forgot to meet me'

(103) na netxa-in kma jeβna-s.
he forget-3sg.sub.(intrans) me meet-inf.
'He forgot to meet me'

⁴⁷ In simple sentences, the verb obligatorily agrees with all its arguments, including indirect and direct objects, while in LDA sentences, only one embedded object (direct or indirect) can trigger matrix verb agreement.

⁴⁸ The Chamorro examples are borrowed directly from Bobaljik and Wurmbrand (2003).

Extending the alternative account proposed for Hindi-Urdu LDA to Itelmen, I suggest the following underlying representation (104) for structures like (101)-(102).

(104) [TP Subj [vP Obj[Subj v [Inf [vP obj [subj v[V obj]]]]]]]]

As in Hindi-Urdu, agreement between the embedded object and the matrix functional verb takes place in a sisterhood relation. Object movement proceeds via the outer specifier of embedded vP. This step places the object in the same minimal domain as the embedded subject (under the assumption that the matrix subject base-generates as the external argument of the embedded verb). From this position, the object locally values the (defective) phi-set on embedded v.⁴⁹

Itelmen then raises a potential puzzle for my proposal. If the object checks the features on embedded v en route to the domain of matrix vP, what contributes to the absence of overt agreement manifestation in Itelmen restructuring infinitivals? Or in other words, what determines this variation between Hindi-Urdu and Itelmen? My tentative response is that tense-dependency lies at the heart of this difference. Unlike Hindi-Urdu, Itelmen LDA does not involve tense-dependency. Therefore even with phi-valuation actually taking place between the object and the embedded verb, infinitivals fail to license this agreement overtly because of the absence of tense-dependency between the two clauses. This claim however needs to be supported by more empirical evidence from Itelmen, which I am unable to do at present. Nonetheless, the lack of tense-dependency may have some direct

⁴⁹ Bobaljik and Wurmbrand (2003, 2005) also assume overt object movement for Itelmen LDA with a lexical restructuring framework.

repercussions for the scope shifting operations in this language. Interestingly, as I discuss later, agreeing objects in Itelmen are also interpreted with wide scope, like LDA objects in Hindi-Urdu. However there is another scope-related difference between these two languages. While Hindi-Urdu LDA allows both surface and inverse object scope readings, agreeing objects in Itelmen always scope over the matrix predicates; i.e. they fail to reconstruct. This difference, I will suggest, results from the absence or presence of tense-dependency between them. Languages like Hindi-Urdu that allow tense-dependency also allow reconstruction to occur more freely than languages like Itelmen that don't.

2.5 Chamorro LDA: A Brief Interlude

Before proceeding further, I would also like to discuss Chamorro LDA in the context of the alternative account presented above. For illustration, consider (105)-(106) that show matrix subjects obligatorily controlling both matrix and infinitival agreement.^{50,51}

(105) Ma'a'nao i patgun ha-taitai esti na lepblu

Npl.rl.in.afraid. the child 3sg.rl.tr-read this linker book

'The child is afraid to read this book'

(106) Man-o'sun I famalao'an ma-dipendi shiha gias Juan

Pl.rl.intrans-bored the women 3pl.rl.trans-depend themselves gias Juan

'The women are tired of depending on Juan'

⁵⁰ Chamorro is a null-subject, verb-initial language with SVO as the unmarked word order. Verbs agree with their subjects.

⁵¹ Chamorro examples cited here are from Chung (2004), unless otherwise stated.

Chung (2004) raises a number of interesting facts about LDA in Chamorro, some of which I discuss here. First, LDA is restricted to restructuring predicates, which are either adjectives, attributive verbs or subject control verbs. One corroborating piece of evidence for their restructuring status comes from long passives like (107), where the embedded object is seen to target a matrix clause position (namely the specifier of TP) for case. Importantly, infinitival agreement is obligatory in such constructions, as illustrated by (108).

(107) Para tafan-ma-chagi ma-na'fanatuk ni lalahi siha

fut. 1pl.ir.in.pass-try npl.rl.in.pass.-hide obl men pl.

‘The men will try to hide all of us’ (lit. ‘We will be tried to be hidden by the men’)

(108) *Para tafan-ma-chagi mu-na'fanatuk ni lalahi siha

fut. 1pl.ir.in.pass-try npl.rl.in.pass.-hide obl men pl.

‘The men will try to hide all of us’ (lit. ‘We will be tried to be hidden by the men’)

LDA sentences also allow their matrix subjects to (sometimes) surface inside the infinitivals. This is shown in (109), which is different from (106) in that its matrix subject appears after the embedded object instead of its usual matrix verb adjacent position.

(109) Man-o'sun ma-dipendi siha i famalao'an gias Juan

Pl.rl.intrans-bored 3pl.rl.trans-depend themselves the women gias Juan

‘The women are tired of depending on Juan’

This pattern is repeated in (110), a yes-no question where the subject once again surfaces inside the LDA infinitival. Compare it with (111), rendered unacceptable with an uninflected infinitive.

(110) kao man-ayuda man-ispaha i chi'lu-hu lahi ni famagu'un
 Q npl.rl.intrans.apass-help npl,rl.intrans.-look.for the sibling-1sg. made obl children
 'Did my brother help look for the children?'

(111) *kao man-ayuda um-ispaha i chi'lu-hu lahi i famagu'un
 Q npl.rl.intrans.apass-help inf.trans.-look.for the sibling-1sg. made the children
 'Did my brother help look for the children?'

Chung also observes that LDA is absent when the proclitic *ti* depicting sentential negation modifies the infinitival (112). The infinitive must remain uninflected under such situations (113).

(112) *Ma'a'nao si Maria ti ha-bisita si nana-na.
 Npl.rl.in.afraid. Maria not 3sg.rl.trans.-visit mother-3sg.
 'Maria is afraid not to visit her mother'

(113) Ma'a'nao si Maria ti bumisita si nana-na
 Npl.rl.intrans.afraid Maria not inf.trans.visit mother-3sg.
 'Maria is afraid not to visit her mother'

On the assumption that *ti* surfaces as part of the content of T, Chung contends from the unacceptability of (112) that infinitivals that participate in LDA lack tense-heads. They are underlying vPs, as schematically shown in (114).⁵²

(114) [TP Subj [vP-2 [vP-1 [VP-1 Obj]]]]

Thus Chung attributes Chamorro the same underlying representation that Bhatt posits for Hindi-Urdu, but without an embedded TP-level. As shown in (114), an LDA infinitival, according to Chung is a vP, capable of assigning structural accusative to its object. Matrix T's phi-set is checked by the matrix subject that base-generates in the specifier of matrix vP and then targets a TP-specifier for case. The puzzling fact is the agreement on the infinitive. Since the matrix subject is not present inside the infinitival at any point of the derivation, it is not possible for it to agree locally with any embedded functional head. Subject-infinitive agreement must therefore take place long distance. Chung's suggestion that this long-distance agreement is accomplished between the two tense heads via Bhatt's co-valuation mechanism: matrix T passes on its phi-value to embedded v after it receives them from the matrix subject.

Our task here is to see if the movement alternative can also be extended to Chamorro LDA and specifically if the co-valuation mechanism can be eliminated. Take for instance the sentence in (105) again, repeated below as (115). My proposed phrase structure for it is given in (116).

⁵² Chung actually assumes that there are two kinds of infinitivals, ones with TP-layers like (113) versus those that are vPs and participate in LDA.

(115) Ma'a'nao i patgun ha-taitai esti na lepblu

Npl.rl.in.afraid. the child 3sg.rl.tr-read this linker book

‘The child is afraid to read this book’

(116) [TP-2 subj T [vP-2 [VP-2 [IP subj to [vP-1[obj [subj [VP-1 read obj]]]]]]]]



I assume that the matrix subject base-generates as the external argument of the lower predicate and targets the specifier of IP before moving to a clause-external position. Inf. has an incomplete set of phi-features that is checked by the subject in a local configuration. However, this relation fails to satisfy the structural case requirements of the subject (given that structural case is obtained only under phi-checking with a non-defective head). The subject is then forced to seek a clause-external head for case. Next, IP is selected by the matrix predicate that in turn is selected by a tense head. Matrix T is non-defective with a complete set of phi-features. The subject targets the specifier of TP for nominative case, wherein it also phi-values T. That said, there raises the following three questions. First, what allows the infinitive to display overt agreement? Second, what explains the obligatory lack of a negative clitic in these sentences? Third, why are subjects allowed to surface only inside inflected infinitivals?

We can answer the first question by appealing to the phenomenon of Tense-dependency, the same mechanism behind the overt manifestation of object agreement in Hindi-Urdu LDA sentences. If Chamorro also allows tense-dependency between matrix and

embedded tense heads, then there is a straightforward explanation for why overt infinitival agreement is possible in this language too.⁵³

The answer to the second question, I believe, also lies in the phenomenon of tense-dependency. If tense-dependency is accomplished via T to T raising, then it must be subject to the Head Movement Constraint (Travis 1984). Understandably, crossing an intervening negative head is bound to violate this constraint, as depicted below in (117). This may be the reason why infinitives must not be inflected when the negative clitic *ti* is present.⁵⁴

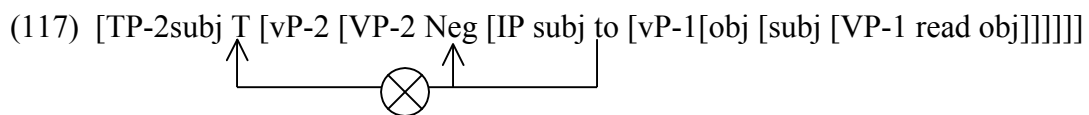

The final issue to tackle is the optional presence of the matrix subject inside LDA infinitivals. Under the movement alternative, a possible answer is that in such cases, PF chooses to spell out a lower copy (left behind in the infinitival) of the raised subject. In addition however, there is a requirement that Inf. carries overt agreement morphology in order to license an overt subject. Since that is possible only under tense-dependency, it is

⁵³ Tense-dependency is not obligatory, as the following example from Chung (1998) with uninflected Inf. suggests.

(i) Ha-chagi [bumaba i petta]
 arg-try inf.open the door
 ‘She tried to open the door’

⁵⁴ Since verb-raising to C is obligatory in the language, verbs cannot intercede T to T raising.

correctly predicted that the subject surfaces only in LDA infinitivals where the phenomenon takes place obligatorily.⁵⁵

With Chamorro now in place, let us turn to the issue of optional agreement and ways of tackling it without positing two different phrase structures for restructuring and non-restructuring infinitivals.

2.6 Remaining issues: Optional Agreement & Default Case

The next case to take up is the mechanism underlying optional agreement. As already discussed in the case of Hindi-Urdu and Itelmen, matrix verbs sometimes bear default morphology (118)-(119). Agree-centered approaches handle optional agreement by suggesting that non-restructuring predicates choose CP/IP complements with PRO-subjects that cause defective intervention and a non-defective *v* that checks structural accusative on the object.

(118) Johnne [roTii khaanaa] chaahaa.

John-erg. bread-acc.fem. eat-inf.def. want.def.perf.

‘John wanted to eat bread’

⁵⁵ Notice that Chamorro has a more general restriction for argument realization inside uninflected infinitivals. Sentence (i), taken from Chung (1998) for instance is ruled out because the embedded argument *Dolores* is illicitly realized inside the uninflected infinitive. Apparently, there is no such restriction on overt object realization.

(i) *Ma’anao i patgun [tumaitai si Dolores esti na lepblu]
agr.afraid the child infin.read Dolores this link book
‘The child is afraid for Dolores to read this book’

(119) na netxa-in kma jeβna-s.
he forget-3sg.sub.(intrans) me meet-inf.
'He forgot to meet me'

I will adopt a different approach here and start with the assumption that infinitivals in non-LDA sentences have defective verbal heads incapable of licensing structural accusative to embedded objects. More concretely, LDA and non-LDA derivations are built from the same set of lexical items or numeration (in the sense of Chomsky 1993), and are identical in terms of their underlying phrase structure. The restructuring/non-restructuring effects instead arise in narrow syntax through the application of two different case-checking mechanisms, one resulting in structural accusative for raised objects and the other in default case-valuation for in situ objects. I have already discussed the first type in the context of LDA. Let us focus on the second type here.

The issue of what is termed here as default case, was first clearly discussed in the context of structures like the following (120)-(121), where objects bear case despite being selected by case-defective or unaccusative verbs.⁵⁶

(120) Poydalla on kirjoja
on the table is book-part
'There are (some books) on the table'

⁵⁶ These Finnish sentences are borrowed from de Hoop (1992).

(121) Syntyi vaikeuksia

arose difficulties-part

‘Difficulties arose/came up’

Belletti’s (1988) solution to the puzzle was to let verbs assign an inherent partitive case to their thematic objects. In the sentences above, objects are licensed by otherwise what are called defective verbs via partitive case assignment. Importantly, this type of case is not restricted to unaccusatives; transitive verbs can also assign it optionally. This is shown by the Finnish sentences in (122) and (123), where the direct object of the transitive verb *buy* is seen to alternate between partitive and structural accusative.

(122) Ostin leipää

I bought bread-part

‘I bought (some) bread’

(123) Ostin leivän

I bought bread-acc

‘I bought the bread’

Partitive alternates with other cases as well. The following examples (taken from Stenberg 1971) show that it can also substitute nominative case on unergative subjects. The difference between these two differently case-marked subjects is that only structural nominative can control verbal agreement. Partitive subjects trigger obligatory default agreement on the verb.

(124) Linja-autoja kulkee nykyisin joka sunnuntai

buses-part run.3sg. nowadays every Sunday

‘Nowadays buses run every Sunday’

(125) Autot ajavat yleensä kovaa moottoriteilla

car-nom. drive-3pl. generally had motorways

‘Cars generally drive fast on the motorways’

The above examples also show that partitive is not associated with any specific theta-role. It occurs to themes of unaccusatives and transitives as well as to agents of unergatives.⁵⁷ Building on this, De Hoop (1992), contra Belletti, establishes partitive as a structural case, albeit a default/‘weak’ type (much on the lines of Vainikka (1989) and Kornfilt (1990)). According to her, default or weak structural case is different from ‘strong’ structural case like nominative or accusative in that it applies at D-structure.⁵⁸ The d-structure/s-structure distinction is no longer available in the minimalist framework, so it is hard to maintain De Hoop’s original characterization of weak or default structural case. But extending on her claims, I will assume that narrow syntax makes use of an alternative, default case-checking mechanism, which exists alongside the mechanism of structural case-checking. The difference between them is not in the level of representation where each applies, but rather in their interaction with phi-valuation. To put in more concrete terms, while structural case is strictly tied to phi-valuation with a functional head, default case checking works independently of it. This tallies well with

⁵⁷ Nor is partitive case restricted to specific predicates.

⁵⁸ Also see Lasnik (1992) for the phenomenon of partitive case-checking.

the general inability of default case-valued DPs to control phi-agreement. The other consequence of its separation from phi-valuation is that there are no structural constraints on its application. Default case is equally available for objects in their VP-internal positions and for left dislocated elements, base-generated in CP-domains. For VP-internal partitive case-valuation, consider the following Turkish examples from Cagri (2004). In (126), the object *cake* receives a default value in its base-generated VP-internal position, as evidenced by its position vis-à-vis the adverbs. Contrast this with (127), where structural accusative objects obligatorily precede the same adverbs.⁵⁹ The German example in (128), taken from De Hoop, on the other hand shows a left dislocated topic receiving a default (nominative) value in the CP-domain.⁶⁰

(126) Ali /dun /kasikla /hizli pasta(*-yi) yedi.

Ali /yesterday /with a spoon /quickly cake(*-acc) ate.

‘Ali ate (some) cake yesterday/quickly/with a spoon’

(127) Ali bu pasta-yi /dun /kasikla /hizli yedi

Ali this cake(-acc) yesterday with a spoon quickly ate.

‘Ali ate this cake quickly/yesterday/with a spoon’

(128) Dieser Mann, den kenn ich nicht

this-nom. man-nom., that-one-acc. know I not

‘This man, I do not know him’

⁵⁹ See Enc (1991) and Cagri (2004) for relevant discussion on specificity in Turkish.

⁶⁰ Default case also applies to quantificational DPs in Finnish, as shown in (i)

(i) Presidentti ampui kaikkia lintuja
 president shot all-part birds-part.
 ‘The president shot all birds’

I will assume that default case-valuation is the reason why Hindi-Urdu and Itelmen have optional long-distance agreement. The underlying structure of a typical non-LDA construction (across an infinitival) is then the following:

(129) [TP Subj [vP Subj v[V [Inf [vP Subj v[VP Obj]]]]]]



I assume that the embedded v in (129) is defective and cannot check structural case on its object, though it can license an external argument, which is also the external argument of the matrix volitional predicate. The object's case is valued default in its base-generated position, which deactivates it for further phi-related computations. As a result, verbal heads in the structure also end up receiving default values for their phi-features. In a nutshell, these structures have no object movement and consequently no object-controlled agreement. The embedded external argument however must move to the matrix subject position for case (and perhaps EPP) via the specifier of matrix vP where it receives a second theta-role.

Therefore as far as the idea of a default case-valuation mechanism is right, there is a straightforward explanation for optional long-distance agreement across infinitivals. Default case-valuation deactivates potential agreement triggers for future phi-computations, consequently forcing functional heads to choose default phi-values. The obvious problem with a default case-checking mechanism is how to constraint it. If narrow syntax allows this option, there should in principle, be no DPs with unvalued

features and a derivational crash should never result from an unvalued case on a nominal. I do not profess to have an answer to this question here and must leave this issue open to future research.

2.7 Whither Kashmiri?

Kashmiri is closely related to Hindi-Urdu and shares many of its features, including its split-ergativity. As in Hindi-Urdu, object agreement is restricted to ergative subject constructions, as shown by the contrast below. Sentence (130) shows obligatory object gender and number agreement whereas (131) shows obligatory nominative subject agreement.^{61,62}

(130) me che kitaab parImIsts

1sg.erg. be-fem.sg.past. book.fem. read

‘I have read the book’

(131) bI chus kitaab paraan

I.nom. be.m.pres.1sg. book read

‘I am reading the book’

Kashmiri also allows long-distance agreement with an embedded object, as illustrated in (132). These structures are similar to Hindi-Urdu LDA in that the infinitive must obligatorily carry the same agreement morphology as the matrix predicate. However,

⁶¹ Finite verbs obligatory target C in simple declarative clauses (see Bhatt 1993).

⁶² Many of the sentences used here are taken from Bhatt (2005) and references cited therein.

what makes Kashmiri especially interesting is its ability to generate structures like (133), where infinitival agreement exists independently of LDA.

(132) raam-an yat-I koori vuchini.
Ram-erg. wanted.fem.pl. girl.fem.pl. to see.fem.pl
'Ram wanted to see the girls'

(133) Raam-an chu hameeSI yotshImut panInis necivis khAAtrI koori
vuchini.
Ram-erg. be.sg.mas.pres. always wanted.sg.mas. self-dat. son.dat. for girls
see-inf.fem.pl.
'Ram has always wanted to see girls for his son'

Likewise, in nominative subject constructions (134)-(135), object infinitival agreement is possible despite the impossibility of triggering object agreement in the matrix clause.

(134) Raam chu yatsaan koori vuchini
Ram-nom be-prs.m.sg. want.impfv. girls see-inf.fem.pl.
'Ram wants to see the girls'

(135) Zoon che yatsaan koori vuchini
Zoon-fem-nom. be-prs.fem. want.impfv. girls see-inf.fem.pl
'Zoon wants to see the girls'

This specific property of Kashmiri poses a serious challenge to my analysis since it indicates that infinitives check structural accusative on their objects, which nevertheless remain visible for phi-computations with main-clause heads. Recall that under the movement alternative, LDA must take place between the embedded object and the matrix verb in a local, sisterhood configuration. Object movement is motivated by its case-checking requirements. We have already seen that in Hindi-Urdu and Itelmen, infinitivals never license structural accusative to their objects and hence object movement to a matrix clause position is naturally triggered for case. However, evidence presented from Kashmiri so far suggests on the contrary; long-distance object agreement as in (132) must occur independent of case-valuation for the object.⁶³

However there is some evidence that supports an extension of the analysis proposed for Hindi-Urdu and Itelmen to Kashmiri LDA. Take for instance, the following nominative subject construction in (136) from Bhatt (1994).

(136) lark chu PRO batI khy-on yets-aan
 boy-nom. aux. food eat-inf. want-perf.

‘The boy wants to eat bread’

The infinitive in (136) is not overtly marked for object agreement, unlike what we observe for other nominative subject sentences in (134)-(135). This sentence is crucial, since it brings out the optional nature of infinitival agreement in Kashmiri. Another

⁶³ Kashmiri also involves clitic-climbing, which unlike LDA, is available for subjects, accusative DOs as well as dative IOs. See Subbarao and Munshi (2000/2003) for useful discussion.

important piece of evidence in this regard comes from long passive constructions like (137).⁶⁴

(137) jaani zAriyi aayi TrakTar Thiik karmic kuushish karnI
John-abl. by came.fem.sg. tractor right do-fem. try do-inf.
'The tractor was tried to be repaired by John'

As illustrated in (137), the embedded object *tractor* raises to the matrix subject position, triggering gender agreement on the matrix predicate. However what is puzzling is the absence of object agreement on the infinitive. Under the assumption that an infinitive always checks case on its object in return for phi-values from it, (137) with its bare infinitive is an unexpected piece of structure. If the object must move through the specifier of embedded vP for case and phi-feature valuation, it is unclear why the infinitive fails to surface with the appropriate morphology. The solution to the puzzle is to assume that in long passives, the object never moves through this position en route to the specifier of matrix TP. Such a movement does not create minimality violations since the matrix subject base-generates as an adjunct and fails to intercede object movement. Hence, at no point in long passives like (137), does the object enter into a case/phi-relation with the embedded verb, which straightforwardly explains the absence of infinitival agreement in these constructions.

⁶⁴ Special thanks to Omkar Koul and Sadaf Munshi for useful discussion on the data. Long passives are not available to all speakers.

In light of this discussion, I will assume that Kashmiri LDA is very similar to Hindi-Urdu and Itelmen LDA in that its infinitivals lack non-defective verbal heads to check structural accusative on their objects, which forces the latter to seek higher heads. In more concrete terms, (132) has the underlying representation in (138).

(138) [TP Subj [vP Obj[Subj v[V [Inf [vP Obj[Subj v[V Obj]]]]]]]]

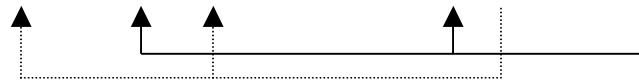

That leaves us with structures (133)-(134), where infinitives independently bear overt object agreement morphology. A tentative answer is that these structures are underlying gerunds and do not structurally resemble infinitivals in LDA sentences. It has been observed with regard to gerunds in Kashmiri that they allow object agreement independently of the nature of matrix clause agreement. This is shown in (139).

(139) mohnIn yi philim vuchIn chu mumkin.

Mohan-gen.sg.fem. this film.fem.sg. see-inf.fem.sg. be.mas.sg.pres. possible.

‘Mohan’s seeing this film is possible.’

The other character of Kashmiri gerunds is that they license subjects. This ability, along with the fact that the gerundive clause often gets case-marked (as shown in (140)) further set them apart from LDA infinitivals, which differ on both accounts. The latter can neither support overt subjects nor bear clausal case.⁶⁵

⁶⁵ (140) is borrowed from Koul and Wali (2006).

(140) Tam'sindis no:kri: me:lina peth go:s bi khosh

He-gen.dat. job get.inf.dat. on went I happy

'I was happy on his finding a job'

Based on these facts, I will assume that (133)-(135) are gerunds with the underlying structure in (141).

(141) [TP Subj [vP [Obj [Subj v[V [IP pro [vP [Obj v[VP Obj]]]]]]]]

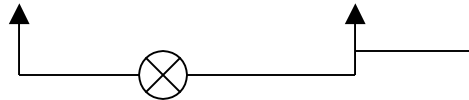

As shown in (141), the embedded clause is an IP with a pro-subject. I also assume that embedded v in such cases is non-defective with a complete set of phi-features that are checked by the object locally. Case-valuation automatically renders the latter invisible for future phi-computations, which explains the impossible to trigger object agreement on matrix heads even in the presence of ergative subjects.

2.8 Implications for Restructuring

Let us now briefly discuss the implications that the alternative has for the phenomenon of restructuring. As we have already seen, previous attempts to explain LDA start with the assumption that the phenomenon is restricted to restructuring infinitivals that are phrase structurally distinct in that they fail to license external arguments as well as accusative case. On the other hand, its absence is a consequence of choosing an infinitival that has exactly the opposite properties; i.e. it licenses an external argument as well as checks

structural case on its object. Under this approach, LDA and non-LDA therefore follow from two different underlying representations for infinitivals.⁶⁶

Contra these studies, the alternative analysis does not blame the LDA/non-LDA distinction on different phrase structures for infinitivals.⁶⁷ Under this approach, infinitivals in languages like Hindi-Urdu, Itelmen and Kashmiri are always IPs with defective tense and verbal heads that fail to license structural case on embedded objects. The second crucial feature of the analysis is that main clause subjects of these control constructions are first base-generated as external arguments of embedded predicates and then forced to move to the matrix clause for theta and case-checking requirements. The final and most important feature is that restructuring effects (long distance object agreement) arise from the absence of a case-valuing head for the object inside the infinitival. The main steps leading to LDA are sketched in (142).

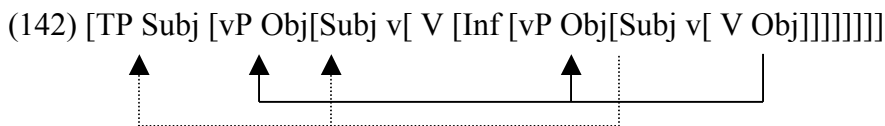

The non-obligatory nature of LDA on the other hand is a natural consequence of a different case-valuing mechanism applied in narrow syntax. Infinitivals underlying such constructions are also IPs with defective heads and are equally transparent for matrix clause computations, as is made apparent by the movement of the embedded subject.

⁶⁶ Since raising constructions are also involved in Chamorro subject-triggered LDA sentences, I leave it out from the present discussion.

⁶⁷ Gerunds are left out of the discussion here.

However, the expected restructuring effects do not arise here because of the implementation of the default case-checking mechanism that results in deactivating the object for all future phi-related computations. Schematically (143):

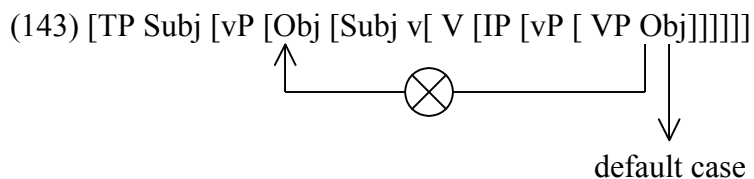

In a nutshell, the conclusion one may draw from this discussion is that restructuring is obligatory in these languages. Or in other words, LDA across these infinitivals is obligatory. It can however be blocked for some other conditions or mechanisms, such as the default case system.

2.9 Implications for QR

I now turn to the consequences that a movement analysis has for the phenomenon of scope and the operation of quantifier-raising in natural language. As I already alluded to, there is a direct correlation between scope and agreement in LDA sentences. Consider a Hindi-Urdu LDA sentence again in (144) where the agreeing nominal can take both wide and narrow scope vis-à-vis the matrix volitional predicate.

(144) Naimne har kitaab parhnii chaah-ii.

Naim-erg. every book-acc.sg.fem. read-inf.sg.fem. want.sg.fem.

Naim wanted to read every book.

Want > every book

Every book > want

Under the movement alternative, wide scope for the object in LDA structures can be accounted for in terms of overt object movement to the specifier of matrix vP.

Schematically (145):

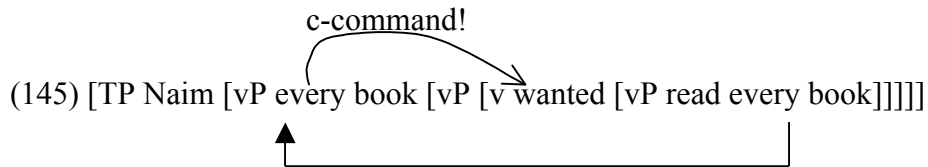

If this is right, then the absence of wide scope for the object (over the matrix predicate) in non-LDA structures like (146) correlates with the absence of overt object movement in such constructions. Schematically (147):

(146) Naimne har kitaab parhnaa chaah-aa.

Naim-erg. every book-acc.sg.fem. read-inf.def. want.def.perf.

‘Naim wanted to read every book’

Want > every book

*Every book > want

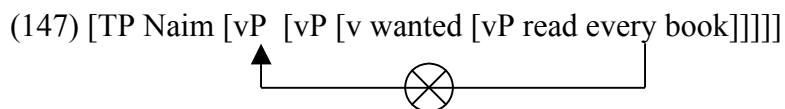

The most important point to note here is that the object in (146)/(147) must not undergo covert QR; otherwise there is no straightforward explanation for why it takes obligatory narrow scope. In light of this, there are two possible approaches to take on scope construal: (i) QR applies at LF as an expensive, last resort operation or (ii) QR is non-existent. The first approach is found in Reinhart (2006). I summarize her work below before revealing some potential problems with it.⁶⁸

The main thrust of Reinhart's work is that a covert operation like QR is allowed only to derive a novel interpretation that is not provided by some overt operation. This is essentially what her generalization in (148) states.

(148) If a derivation D converges without application of some covert operation, then that application is disallowed.

According to Reinhart, QR is a marked operation that applies at the interface only when other members of a given reference-set fail to generate an identical interpretation via overt, narrow syntactic operations.⁶⁹ In other words, if the same interpretation can be attributed to a given derivation via overt operations, QR is inapplicable for it. Reinhart motivates this by claiming that the operation comes with an additional expense; its application requires constructing reference sets. QR is allowed only upon comparison with other representations. This entails the use of reference set computations or

⁶⁸ Also see Fox and Nissenbaum (1999) for ideas of overt QR.

⁶⁹ The markedness approach to scope was first stated in Keenan and Faltz (1978) where lambda abstraction was assumed to apply only for marked scope.

“transderivational” comparisons (in the sense of Hankamer 1973) in determining scope in natural language. However in principle there is a large set of derivations that the specific LF representation could be compared with. Therefore in order to make the task of transderivational comparison computationally feasible, the set of derivations to be compared with must be severely narrowed down. To this effect, Chomsky (1993) introduces the notion of a numeration, a set of lexical items employed in a derivation. The notion of a numeration reduces the reference set by limiting its membership to only those derivations that are computed from the same list of lexical items. Derivations must be built from the same numeration in order to be compared with each other.

Let us examine how numeration-based reference set computations can be used to determine scope in Hindi-Urdu non-LDA constructions. Contra previous accounts where LDA and non-LDA sentences are assumed to result from two different numerations (one with a restructuring predicate selecting a VP complement and the other with a non-restructuring predicate choosing a CP complement and an embedded PRO subject), I have claimed for the alternative analysis that both derivations are derived from the same set of lexical items. The crucial difference between LDA and non-LDA sentences is that only the former has overt object movement. Since these derivations are built around the same numeration, they are members of the same reference set and are thus comparable. LF then takes the other members of the reference-set into consideration while considering QR for the non-LDA construction. Since there exists a derivation where the same

interpretation is achieved without applying QR (in our case, the LDA construction), the option of QR is ruled out for the non-LDA sentence.⁷⁰

That said, there are some problems with Reinhart's concept of QR that force me to reject it as an analysis for scope alteration in LDA and non-LDA sentences. First however note that her use of the term 'convergence' as in (148) is different from its usual connotation in linguistic theory where a derivation is said to 'converge' only when it satisfies all (feature checking) requirements that make it readable to the semantic and phonetic interfaces. A derivation that fails to converge at both levels is excluded from the grammar of a language. In Reinhart's view on the other hand, 'convergence' is not used in its narrow sense; rather, it implies that if a grammatical sentence can receive an interpretation without one of its elements undergoing a covert operation like QR, any other grammatical derivation ensuing from the same numeration will also fail to apply QR. However that raises a question as to why QR must apply as 'a repair strategy'. Since there are no derivations to repair, it is unclear as to why QR must ever apply to any derivation. Given that these derivations are all grammatical outputs with some specific interpretation, QR, assuming that it is a repair strategy, will always be inapplicable. Moreover, in many cases, it is not obvious as to what the alternative derivation (to

⁷⁰ Fox's approach to QR differs from Reinhart's in that it makes it obligatory to adjoin a quantificational object to vP and a quantificational subject to TP, presumably in order to allow the Q-operator to bind a variable. Beyond that initial step, object QR becomes expensive and is undertaken only to generate a different interpretation. Secondly, Fox's theory also entails that all members of the reference set must undergo some step of QR. The reference set does not involve derivations with no QR. Derivations with object QR to vP, for instance, are compared with those involving object QR to TP and crucially not with derivations without object QR. This constitutes the second important aspect of Fox's theory. His theory makes no provision for comparing covert derivations with overt ones. Under this approach, there is no way on ruling out object QR to matrix vP or TP for non-LDA constructions, based on comparison with existing scope construal of LDA constructions. If we follow Fox, we incorrectly predict wide scope for objects in Hindi-Urdu non-LDA structures.

compare with) should be. Take for instance, the ambiguous sentence in (70), repeated below in (149).

(149) A boy loves every girl.

If we adopt Reinhart's theory, the surface scope in this sentence (*a boy* > *every girl*) acquired through overt movement of the subject to the specifier of TP, is the unmarked interpretation. However as I have already discussed, this sentence is ambiguous and can also be read as *every girl* scoping over *a boy*. The problem is that in order to get this marked reading via QR, the grammar must compare this sentence with other derivations resulting from the same numeration. The first problem is that there are sentences like *every girl loves a boy* that can be also generated from the same numeration, but cannot be compared with (149).⁷¹ Secondly, the only derivation that this sentence can be compared with is (149) itself, which already has an interpretation and hence will reject QR to get a different reading, of course incorrectly.

The other approach before us is to assume that a covert scope-shifting operation like QR is non-existent. Scope construal is restricted to the outputs of overt operations. There are no covert transformations like QR dedicated to generating scope interpretations not made available by overt, narrow syntactic computations. Before I move on to reexamine the LDA/non-LDA scope distinction under this alternative approach, let me first explain how inverse scope is attained in (149). If there is no QR, then object scope over the subject

⁷¹ This is of course under the assumption that different nominal expressions are not already marked with specific case-values (to be checked against appropriate functional heads); i.e. they are non-distinct with respect to case inside the numeration.

cannot be achieved by adjoining the object to TP. I claim, following Hornstein (1995) that inverse scope is obtained via reconstruction. In this particular case, the subject reconstructs back to the specifier of vP where it base-generates as the verb's external argument. From this position, the object which moves to the outer specifier of vP for case c-commands and consequently scopes over it. This is shown in (150). Note that reconstruction is not a transformation. In a system, where movement leaves behind copies, reconstruction is merely the consideration of one of the lower copies. In (150), the lower copy of the subject is considered for scope purposes, leading to inverse scope reading for the sentence in (149).

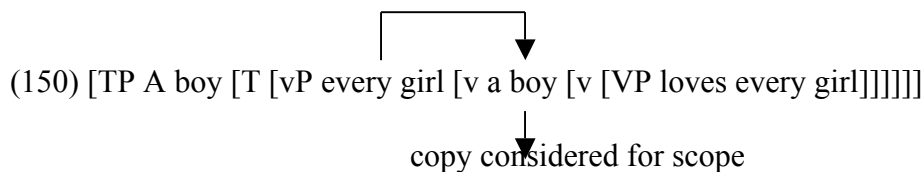

Returning to the existing scope contrast between LDA and non-LDA sentences, I claim that this too arises from the presence or absence of overt object movement. Agreement triggers in the former move overtly to a position c-commanding the volitional predicate, which explains why they scope over the latter. In non-LDA sentences on the other hand, the object remains in situ and scopes below the matrix predicate. There is no QR operation that can alter scope relations at LF.

Notice however that wide scope is not obligatory for LDA objects; they can also scope below the volitional predicates. Narrow object scope, I claim, arises from considering its

lower copy in the embedded clause. This is shown in (151), where the lower copy of the raised object is c-commanded by the matrix predicate.

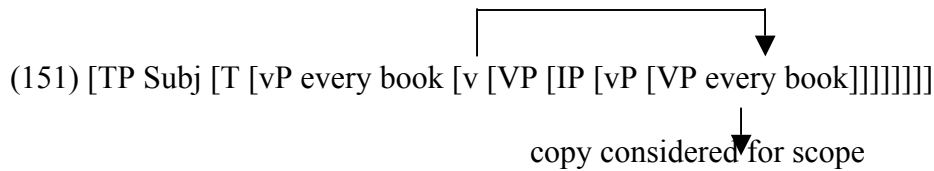

I now turn to an interesting difference between LDA sentences in Hindi-Urdu and other languages like Itelmen. Compare (144) with the Itelmen sentence (152).

(152) t'-antxa-ce?n [mil okno-?n sop-es]
 1sg-forget-3pl.OBJ all window-pl. close-inf.
 'I forgot to close all the windows'

All windows > forgot

Forgot > all windows

In (152) taken from Bobaljik and Wurmbrand (2003/2005), the embedded object triggers agreement on the matrix predicate across the infinitival boundary. What makes this sentence interesting is that its agreement trigger, unlike what we observed with Hindi-Urdu, receives an obligatory wide scope interpretation. This sentence is felicitous with the reading where all the windows are left open. The inverse reading where some of the windows are left open is unavailable here. Under the present approach, this means that Itelmen agreeing objects take scope over matrix volitional predicates by overtly moving to the specifier of matrix vP for case. The absence of narrow scope follows from the

inability of the object to reconstruct; i.e. its copy in the embedded clause, for reasons to be made clear shortly, is not recognized for scope considerations. Hindi-Urdu restructuring sentences in fact seem very unique in this respect. Languages like German and Japanese pattern like Itelmen in assigning obligatory wide scope to arguments of their restructuring infinitivals. This point is illustrated by sentences (153) and (154) from Japanese and German respectively.

(153) John-wa subeto-no ringo-o tabe-wasure-ta.

John-top. all-gen. apple-acc. eat-forget-pst.

‘John forgot to eat all the apples’

All the apples » forget

*forget » all the apples

(154) weil er alle Fenster vergessen hat [t-obj. zu schließen]

since he all windows-acc. forgotten has [t-obj. to close]

‘Since he forgot to close all the windows’

All windows » forget

*forget » all the windows

In both constructions, the embedded nominal scopes over the main predicate ‘forget’. To elaborate on the interpretation, sentence (153) is felicitous only with the reading where all apples are left uneaten; similarly, in (154), all the windows must be left open. The opposite readings with narrow scope for the objects are disallowed. Scope rigidity here is taken as suggesting that the nominal fails to reconstruct back to its base-generated

position wherein it may scope under the said predicate. Bobaljik and Wurmbrand, based on these anti-reconstruction effects make the following generalization:

(155) Induced Domain Generalization: VP-complements of lexical verbs form separate agreement domains.

The core idea is that agreement domains are defined in part thematically, such that a VP and the projection of v selecting it constitute a single agreement domain. The following diagram depicts one agreement domain formed out of the thematic domain VP and the agreement domain vP.

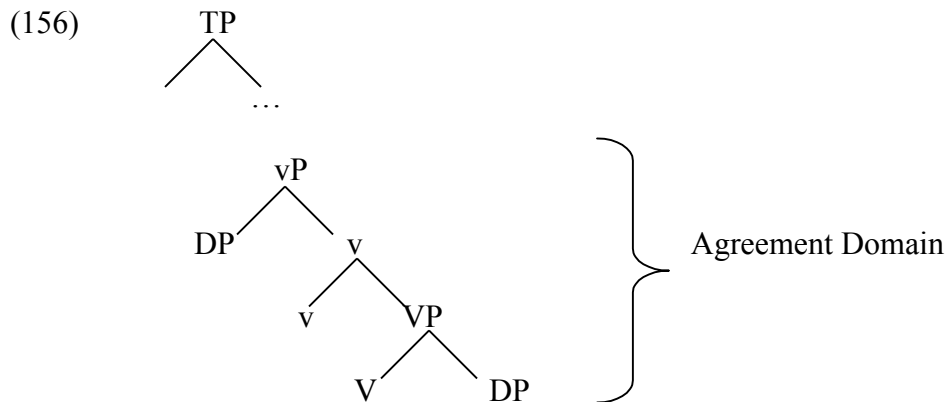

In the case of lexical restructuring verbs however, the VP complement constitutes an independent agreement domain since the higher verb begins its own thematic domain. This is shown in (157), which is the underlying representation that Bobaljik and Wurmbrand suggest for the German lexical restructuring construction in (154). Observe that unlike (156), there are two agreement domains in this structure, the first consisting of

the lower VP (i.e. VP-2) and the second consisting of VP-1 and vP.

(157)

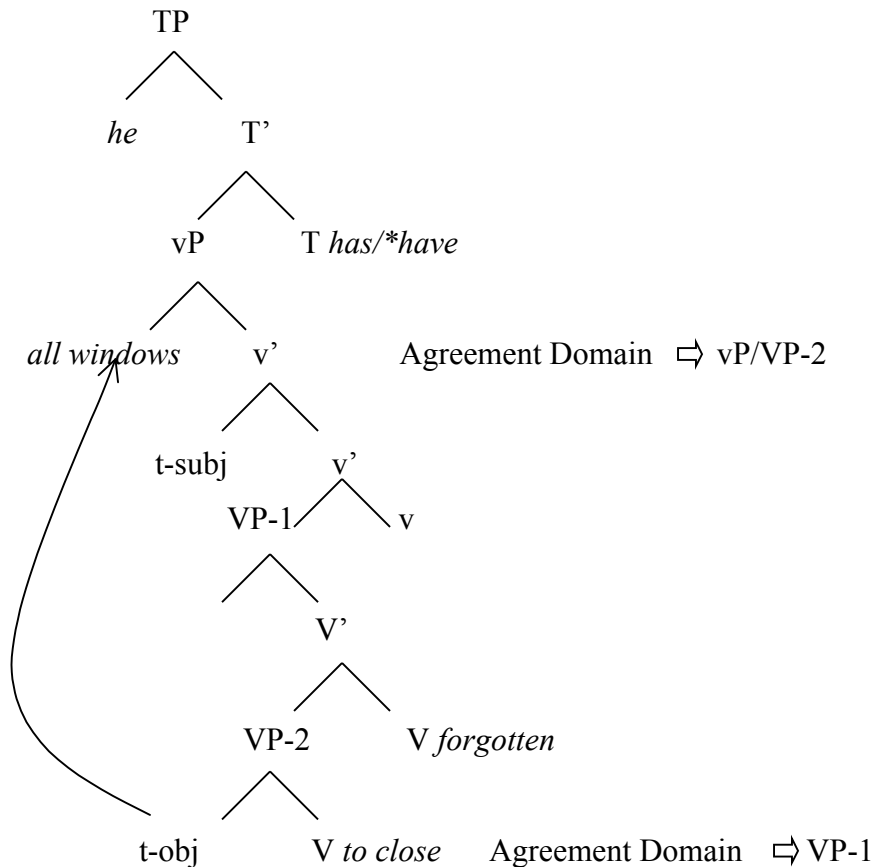

As illustrated above, the lexical restructuring predicate ‘forget’ selects VP-2, which is devoid of all functional layers. The lower verb – being lexical – nonetheless constitutes an agreement domain. But since it lacks case/agreement checkers, all embedded nominals must move over to (matrix) agreement domains, which for present purposes is the specifier of matrix v. Bobaljik and Wurmbrand then make a second crucial assumption: all checking relations must be preserved at LF. This assumption comes with a necessary corollary (158).

(158) Agreement-scope correlation:

A DP may not be interpreted (for scope and binding) in a position lower than in the domain in which it undergoes Case/agreement-checking.

Since all agreement relations established in narrow syntax must be preserved till LF, nominals that enter into case-agreement relations in a domain different from their base-generated agreement domain are not allowed to reconstruct. Reconstructing DPs would destroy relevant information for LF. Hence it follows that raised nominals in Itelmen, Japanese and German lexical restructuring constructions do not reconstruct back to the original agreement domain, namely VP-2. Consequently, they end up with obligatory wide scope over matrix predicates. Bobaljik and Wurmbrand then go on to claim that the reason wide scope is optional in Hindi-Urdu restructuring constructions is because it is only in this language that the agreeing nominal never moves beyond the embedded IP. The object targets the specifier of IP from where it enters into a long distance agreement relation with a matrix head. At LF, it optionally undergoes QR to take scope over the volitional verb. It may however choose to remain in its IP-specifier position, thereby ending up with optional narrow scope vis-à-vis the same predicate.

As opposed to Bobaljik and Wurmbrand, I suggest scope variation between these languages arises from the phenomenon of tense-dependency. Recall that Hindi-Urdu infinitivals do not carry agreement morphology so long as they are not embedded under restructuring predicates like *want* that carry overt object agreement. I took this to indicate

that Hindi-Urdu LDA has obligatory tense-dependency between the two clauses that facilitates the infiltration of tense in the embedded clause, allowing it to morphologically manifest the local phi-relation between the object and the verb. In direct contrast, Itelmen infinitivals in LDA constructions do not show overt agreement, which can be explained only if we assume that these sentences lack tense-dependency. Hence, Itelmen infinitivals are unable to trigger agreement even when embedded under restructuring predicates. If true, it is reasonable here to correlate tense-dependency with the variation in object reconstruction. The generalization in (159) is an attempt in this direction:

(159) Only LDA (or restructuring) sentences with tense-dependency allow reconstruction of raised agreement triggers.

Given (159), tense-dependency or T to T raising in Hindi-Urdu generates a single tense domain within which all copies of the raised item can be considered for scope interpretation. I claim that the domain for reconstruction is the entire phrase (i.e. TP) headed by the tense-complex. This is illustrated in (160).

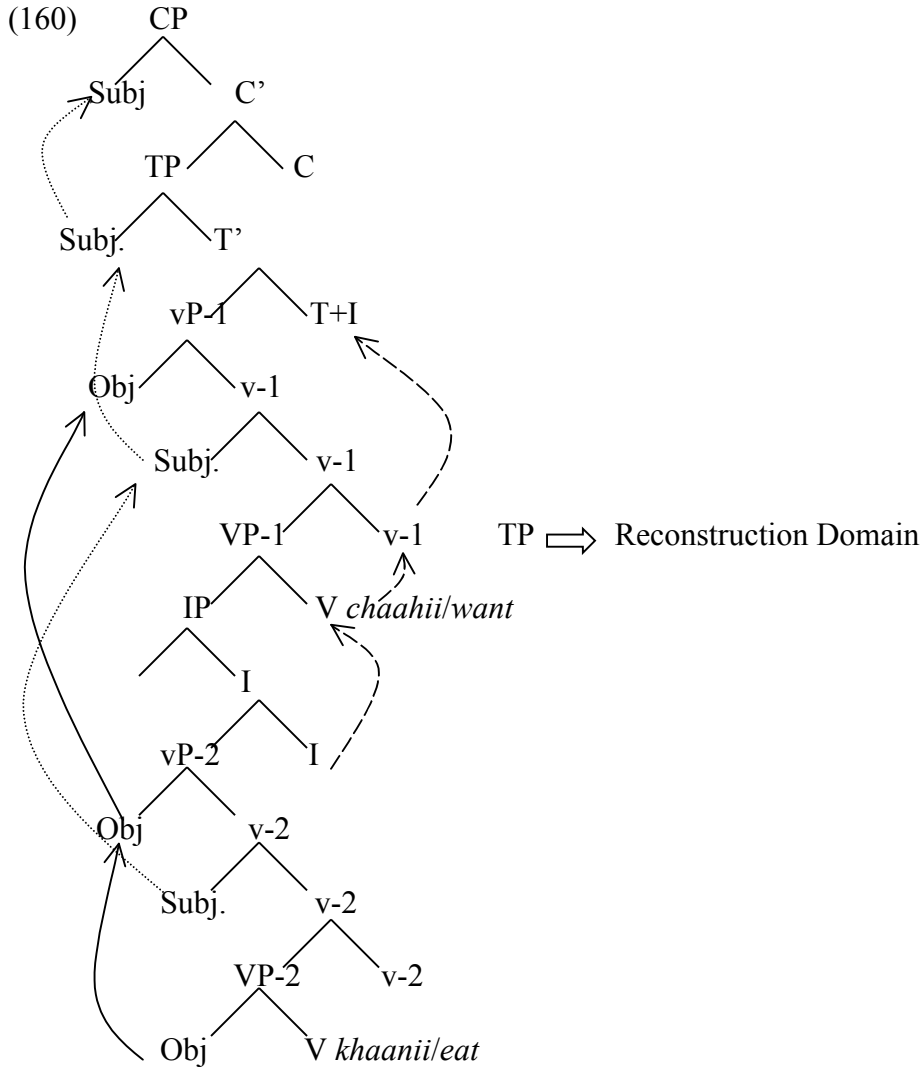

There is independent evidence that corroborates the absence of tense-dependency in languages that do not allow object reconstruction. Consider the following sentence from Wurmbrand (2001) for illustration:

- (161) Hans hat versucht (*morgen) zu verreisen
 John has tried (*tomorrow) to go-on-a-trip
 'John tried to go on a trip (*tomorrow).

Wurmbrand argues on the basis of examples like (161) that restructuring predicates select tense-less infinitivals that fail to license temporal-modifiers including past and future adverbials. These complements lack tense heads and fail to establish tense-dependency with matrix events. That is, the event time of the embedded verb fails to consider the matrix event time as its reference time. Sentence (161) cannot be interpreted as implying that the event of going on a trip follows the event time of John's trying. Instead of tense-dependency, the two clauses share what Wurmbrand calls a "simultaneous" interpretation. To obtain a simultaneous interpretation, it is not enough to evaluate the truth-value of the sentence in the real world. Rather, the irrealis nature of the infinitival must take into consideration all possible worlds where the embedded event might hold. In more precise terms, "the simultaneous character of try-contexts is not a simultaneity between two actual events, but rather between the (actual) event of trying and whatever the subject thinks will bring about the situation described in the infinitive" (Wurmbrand:75). Similarly for long passives, which are rendered infelicitous with temporal adverbials, as shown by (162) below.

(162) Dem kind wurden nur kekse (*morgen) zu essen erlaubt.

The child-dat were only cookies (*tomorrow) to eat allowed

'The child was only allowed to eat cookies tomorrow'

The situation in Hindi-Urdu is very different. We find, as in (163) that embedded events

are easily interpreted with event times following the event time of the matrix clause.⁷²

The following sentence is felicitous in a situation where the event of eating bread occurs (or is about to occur) in two days following the event of wanting.

(163) Johnne aaj se do din baad roTii khaanii chaahii.

John-erg today from two days bread-fem. eat-inf.fem. want-fem.perf.

‘John wants to eat bread two days from now’

This contrast between German (161)-(162) and Hindi-Urdu (163) support the claim that tense-dependency has some impact on object reconstruction. While German like Itelmen lacks tense-dependency and also disallows object reconstruction, Hind-Urdu allows both.

It is important to note here that tense-dependency between the two clauses in Hindi-Urdu does not necessarily indicate a mono-clausal structure for LDA sentences that might facilitate reconstruction for all raised nominals. Tense-dependency generates a TP domain that is used as a single domain for reconstruction. Since all copies of the object are within the TP, each one is an equally plausible candidate in the determination of scope. Elements that surface beyond the TP domain, even if they are originally generated within the TP, cannot be reconstructed. This is what we observe with ergative subjects in LDA sentences. These DPs cannot reconstruct since their highest copy is outside the domain of TP (namely the specifier of CP). Hence they end up receiving obligatory wide scope over the object, as shown in (164).

⁷² The morpheme ‘kal’ is ambiguous between ‘tomorrow’ and ‘yesterday’ in Hindi-Urdu, which is why I choose a different temporal adverb in (163).

(164) kisi shaayarne [har ghazal paRhni] chaahii.

Some poet-erg. every poem-acc.sg.fem. read-inf.sg.fem. want.sg.fem.perf.

‘Some poet wanted to recite every poem’

some poet > every poem

*every poem > some poet

Interestingly, we find that when the object scrambles out to the left periphery of the tree, the scope patterns change (165). In this case, the object must scope over the matrix subject. There is only possible interpretation for the sentence: *for every poem, there is plausibly a different poet who wants to recite it.*

(165) har ghazal kisi shaayarne [t-i paRhni] chaahii.

every poem-acc.sg.fem some poet-erg. read-inf.sg.fem. want.sg.fem.perf.

‘Some poet wanted to recite every poem’

*some poet > every poem

every poem > some poet

Scope rigidity in (165) follows naturally if we assume that the object scrambles out of the TP domain to a position in the domain of CP. Since the highest copy of the object is outside the TP domain, it cannot reconstruct back to a position where the ergative subject may c-command and consequently scope over it.

2.10 Conclusion

To conclude, this chapter revisited LDA sentences across restructuring infinitivals in Hindi-Urdu, Itelmen, Kashmiri and Chamorro. A careful investigation of previous Agree-based accounts showed that they do not sufficiently explain the phenomenon. As opposed to these approaches, the movement-based alternative that I propose captures not only the full range of the phenomenon but also explains the scope effects associated with these constructions without alluding to an operation like QR.

Till this point, I have focused exclusively on languages where DPs move because their case is left unchecked in their base-generated positions. Moreover, the clauses containing these arguments also do not bear any case/phi-agreement markers, suggesting that they themselves are not rendered inactive from case-valuation. In other words, all cases hitherto examined seem to obey Chomsky's (2001) Activation Condition that restricts phi-computations to non-case-valued DPs. However there are various cross-linguistic instances of cross-clausal agreement, which seemingly disobey the Activation Condition on both accounts. First, the agreement triggers get case-valued in embedded clauses and yet control main-clause verbal agreement. Second, clauses containing these agreement triggers are also optionally case-valued. This raises the following question. Assuming that the Activation Condition is an axiom of the grammar, under what circumstances can the condition be overruled? What propels phi-agreement with inactive goals across 'impervious' domains in some languages? These and similar questions constitute the agenda of the next chapter.

CHAPTER 3

AGREEMENT ACROSS FINITE DOMAINS

This chapter is about agreement patterns that transcend constraints imposed by finiteness. A standard impression in the literature is that A-movement and phi-agreement are finite clause-bound; i.e. elements are case-marked inside finite clauses where they base-generate, which consequently makes them inept for cross-clausal movement for agreement and case. This widely held view has recently been challenged by works on languages as diverse as Chukchee, Hungarian, Innu-aimûn, Passamaquoddy, Tsez among others, that typically allow their arguments to control agreement beyond their finite clause boundaries. Existing literature dealing with these structures generally agree on the following points. First, they are derived by long-distance Agree; i.e. the agreement trigger need not be in the domain of the agreeing head. Second, agreement/Agree is not subject to the same constraints obeyed by A-movement/Move; i.e. agreement/Agree is available across finite boundaries but A-movement/Move is not. Third, assuming that finite clauses involve non-defective heads (v and T), which are legitimate case-checkers, phi-agreement with case-marked nominals must be the norm in the grammar. Therefore, the Activation Condition – which permits only non case-marked nominals to participate in phi-computations – must be eliminated as an axiom of the system. It is my objective to show in this chapter, that none of these observations – with regard to LDA across finite boundaries – are right. I argue, first, that agreement is always obtained in local configurations, via A-movement. Secondly, agreement/A-movement is confined to finite

clauses, though the constraint can be relaxed under certain circumstances. One such situation arises when the agreement trigger is endowed with an extra A-bar feature (topic, focus) that propels it to sideward move to the adjoining tree. It begins its next derivational journey as the object to the matrix predicate, with a second theta-role assigned to it. Building on Chomsky's (1986a) Visibility Condition that dictates that case-valuation is necessary for theta-evaluation at LF, I contend that a second theta-role in a different derivational workspace goes hand in hand with a second structural case for the nominal. The extra structural case gets checked as a reflex of phi-agreement between the moved argument and the matrix head. The Activation Condition remains unaltered.

I begin by introducing the LDA structures considered in this chapter, and some general problems they pose for agreement and movement theories. Section 2 is on Tsez LDA, where I critique the Agree-based accounts of Polinsky and Potsdam (2002), Bhatt (2005) and Boskovic (2005). An alternative analysis is developed and corroborated with more data from Chukchee, Innu-aimûn, Passamaquoddy and Hungarian in sections following that. After this, I turn to discuss a rather unusual case of 'number LDA' in Basque. The final section is the conclusion.

3.1. Agreement, A-movement and Finiteness: Some initial remarks

In the next few sections, we will be mainly concerned with LDA sentences in Tsez (1), Chukchee (2), Innu-aimûn (3), Passamaquoddy (4), Hungarian (5) and Basque (6).

- (1) eni-r [uz-a magalu b-ac-ru-li] b-iy-xo.
 mother-dat. [boy-erg bread.III.abs. III-eat-pstprt.nmlz] III-know.pres.
 ‘The mother knows the bread, the boy ate’
- (2) ənən qəlyiļu ləŋərkə-nin-et [iŋqun Ø-rətəmŋəv-nen-at qora-t].
 he-inst. regrets-3-pl. Comp 3sg-lost-3-pl reindeer-pl.nom.
 ‘He regrets that he lost reindeers’
- (3) N-u î-tshissenim-âu tshetsh î mupihtâshkuenit kassinu kâuâpikueshit
 1-want-know-3 if visited-2/inv. every priest
 ‘I want to know of them if every priest visited you’
- (4) Susehp ‘-kosiciy-à akòm eli Muwin kisi-mil-at Wiphun
 Susehp 3-know.TA-dir.obv.p.snowshoe-obv.p. comp Muwin perf-give-3com. Wiph.
 ‘Susehp knows that Muwin gave Wiphun snowshoes’
- (5) EGY NÖ-T-i akar-ok, hogy t-i elnök legyen
 a woman-acc. want-1sg.indef. that president be-subj.3sg.
 ‘I want that a woman become the president’
- (6) [nobela erromantikoak irakurtzea] gustatzen zaizko
 novel romantic-pl.A read-N-det.A like-hab aux-3pl.A-3singD
 ‘He/she likes to read romantic novels’

The common thread underlying sentences (1)-(5) is that their agreement triggers are arguments of embedded finite complement clauses. The term ‘finite clause’ here, is used to designate non-defective TPs that can license structural case to subjects. Tsez, Innu-aimûn, Chukchee, Passamaquoddy and Hungarian all qualify in this regard; clausal

complements in their LDA sentences are either TPs or CPs, verified by the presence of embedded, lexical subjects, finite verbal morphology and/or the presence of overt complementizers.¹ A second defining characteristic of these languages – that is relevant for our discussion here – is that their complement clauses optionally trigger phi-agreement on the verb that selects them. LDA triggers therefore not only flout finite boundaries in (1)-(5), but they also compete with their phi-feature bearing clauses (see below for more). Basque LDA in (6), on the other hand, is slightly different, as it is restricted to obligatory-control (OC) infinitivals. However the reason for clubbing Basque together with the rest of the languages here is precisely because it too – like the rest of them – allows its clauses to control main-clause verbal agreement and what is even more important, to bear structural case.²

A study of phi-agreement out of finite complements is interesting for several reasons. First, it challenges the Activation Condition. Embedded arguments in (1)-(6) are all case-marked in the downstairs clause, and by the Activation Condition, they are ineligible goals for long-distance agreement, contrary to fact. Apart from this, these structures provide formidable proof that phi-agreement is distinct from A-movement, which is generally considered (finite) clause-bound. Observe:

¹ San Martin (2004) claims that finiteness is irrelevant for overt subject licensing. In her understanding, lexical subjects are licensed when C is filled by language-specific strategies. I do not adhere to her idea here and instead assume that lexical subjects are licensed in the specifier of TP (headed by non-defective, structural case-assigning T).

² As opposed to Basque, clausal case in other languages makes LDA with an embedded argument impossible. (i) is such an instance from Hindi-Urdu (thanks to Shiti Malhotra for discussion).

(i) Johnne [roTii khaane/*khaani]-ko chaahaa/*chaaahii.

John-erg bread-fem. eat-inf/*fem-case want-def/*fem.

‘John wanted to eat bread’

It must be noted however that structures such as (i) with clausal case are not readily acceptable to all speakers of Hindi-Urdu.

(7) John-i seems [Inf t-i to be genius].

(8) *John-i seems [TP t-i is genius].

The embedded subject A-moves (for case/phi-checking) to the canonical subject position (specifier of TP) in the matrix clause in (7), this movement being licit across an infinitival.³ A-movement across a finite clause is however banned. In (8), for instance, *John* receives a structural case value from embedded T and is consequently stranded in the specifier of lower TP. In contrast, what we find in examples like (1)-(6) is prima facie evidence that such constraints do not apply to agreement. A nominal's phi-value is apparently visible to heads outside its finite clause. This discrepancy between A-movement and phi-agreement has propelled some researchers to suggest that not only are they derived by different operations (Move versus Agree), but the operations themselves are governed by different locality conditions (see Boskovic 2005). While Move is local and constrained by the Phase Impenetrability Condition/PIC (see Chomsky 2000), Agree is immune to all such constraints.

The claim that A-movement is clause-bound is however not uncontroversial. Ample evidence contradicting this claim is presented in Xu (1993), Ura (1994), Ferreira (2000), Fujii (2005), Rodrigues (2004) and Hong (2005), among others. Below are a couple of representative examples from Brazilian Portuguese (9) and Korean (10). Embedded

³ In an Agree-based framework, phi-feature and case-valuation takes place long-distance and movement to the specifier of TP is just for the EPP (cf. Chomsky 2000).

arguments in both sentences A-move (also evidenced by agreement on higher predicates) to the matrix clause, crossing intervening CP-boundaries.⁴

(9) Os meninos parecem que estão doentes.

The boys-pl seem-pl that are-pl sick-pl

‘It seems that the boys are sick’

(10) Halapeci-kkeyse cengcikha-si-ess-tako mite-ci-si-n-ta

Grandfather-hon.nom. honest-hon-past-comp believe-pass-hon-pres

‘It is believed that my grandfather was honest’

Since an in-depth study of hyper-raising structures like the ones given above is beyond the scope of the present chapter, I will restrict myself to a couple of observations about them that are directly relevant for the present study. As is obvious, the phenomenon of hyper-raising poses a challenge to the Activation Condition. If embedded heads are non-defective in that they are legitimate structural case-checkers, A-movement out of finite clauses cannot be correlated with the structural case-checking requirements of the moving element. Hyper-raising is therefore, at first glimpse a violation of the Activation Condition. But this observation is evidently not correct. Languages that allow hyper-raising appear to employ independent strategies to keep their DPs active with unchecked structural case. Brazilian Portuguese sentences like (9) for instance, Rodrigues (2004) argues, are instances of DP movement to the specifier of matrix TP for case checking requirements. The language evidently allows a defective Agr. head to satisfy the EPP

⁴ Thanks to Acrisio Pires for the Brazilian Portuguese example. The Korean sentence is from Hong (2005).

feature on embedded T. Assuming that case-checking is restricted to specifier-head configurations, Rodrigues claims that the subject fails to receive a value for its structural case from embedded T in a specifier-head configuration, which then forces it to seek a probe in the higher clause. For hyper-raising constructions in Korean (10), on the other hand, if Hong (2005) is right, raised nominals are case-valued in the lower clause. But Korean, being a multiple case-checking language, does not immediately erase the case from the DP, which is just another way of saying that the nominal remains active with a (second) unchecked structural case even after it has already received a case-value.

This brief discussion on hyper-raising was meant to emphasize the fact that though the phenomenon is restricted, A-movement out of finite clauses is not universally banned. Languages may employ different strategies to keep their DPs active for long-distance raising, case and phi-related computations. Herein lies the motivation for the present study. With respect to LDA across finite boundaries, I suspect that languages have options of not only reactivating their case-marked nominals, but also raising them out of their original theta and case-domains. If true, then LDA structures are essentially underlying hyper-raising constructions. It is this quest, which will guide me through the rest of this study.

As must be obvious from the discussion so far, I am assuming a correlation between phi-agreement, case-valuation and A-movement. Some researchers (cf. Polinsky and Potsdam 1999, 2002; Branigan and MacKenzie 2002), on the other hand, claim that LDA is agreement triggered from an A-bar topic position and is not related to case-valuation.

Though it is true that agreement triggers are typically either topics or focused elements, there is some evidence that suggests that LDA involves case-valuation too. As for instance, in some languages like Hungarian that allow LDA with focus and wh-elements, it is also obligatorily accompanied by case-switch on the agreement trigger. The raised argument surfaces with a different case value from the one it receives in the embedded clause. This suggests that the matrix verb has case-valued it as reflex of phi-agreement. Some relevant examples are given in (11) and (12), where the focused item *a woman* and the wh-phrase *who* that are also embedded subjects receive accusative case respectively on targeting a position in the main clause.

(11) EGY NÖ-T-i akar-ok, hogy t-i elnök legyen
 a woman-acc. want-1sg.indef. that president be-subj.3sg.
 ‘I want that a woman become the president’

(12) KI-T-i akar-sz, hogy t-i elnök legyen
 who-acc. want-2sg.indef. that president be-subj.3sg.
 ‘Who do you want to become the president?’

In addition, Hungarian allows long-distance extraction of focus and wh-movement to the exclusion of LDA and case-switch. This is shown in the examples (13)-(14). The fact that A-bar elements can move without necessarily altering previously attained case-values suggests that there are two different operations underlying the derivations of sentences in (11)-(12) and those in (13)-(14).⁵

⁵ These examples are from Den Dikken (2005), who uses the % sign to indicate idiolectal variation.

(13) %EGY NÖ-i akar-om, hogy t-i elnök legyen
 a woman-nom. want-1sg.def. that president be-subj.3sg.
 ‘I want that a woman become the president’

(14) % KI-i akar-od, hogy t-i elnök legyen
 who-nom. want-2sg.def. that president be-subj.3sg.
 ‘Who do you want to become the president?’

In what follows, I will be mainly concerned in revealing the mechanisms underlying the derivation of sentences of the former type. I will assume that though the phenomenon of LDA piggy-backs on A-bar movement strategies like topicalization, wh-movement and focalization, it is accomplished in local, A-positions, and crucially involve case-valuation for the DP. I propose (15) as the underlying representation for sentences with LDA across finite clauses.

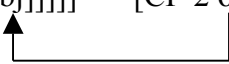
(15) [CP-1 [TP-1[vP-1 obj [v[VP-1 obj]]]]] [CP-2 obj [CP-2 ...[vP-2 obj]]]

The argument of CP-2 sideward moves to the complement position of the matrix verb (V-1) before targeting the specifier of vP-1 for phi-checking and case-valuation. There are of course some non-trivial differences between these languages with regard to the exact implementation of this process, that I will bring up in due time. Let us begin the inquiry with Tsez.

3.2 Tsez: LDA and some other facts

To start, Tsez (a Nakh-dageshtanian language spoken in the Caucasus) is a predominantly agglutinating, morphologically ergative language. Subjects of transitives bear ergative case, whereas intransitive subjects and transitive objects are case-valued absolutive.⁶ A couple of representative examples are given below in (16)-(17).

(16) ziya b-ik'i-s.

cow.III.abs. III-go-pst.evid.

'The cow left'

(17) eniy-a ziya b-iser-si.

Mother-erg. cow.III.abs. III-feed-pst.evid.

'The mother fed the cow'

Verbal agreement – morphologically manifested in terms of four noun-classes with number (singular/plural) variation- is controlled by absolutive DPs, which are either intransitive subjects (16) or objects (17). Similar agreement patterns are also observed in bi-clausal structures. Tsez allows main clause verbal agreement to be optionally controlled by an argument of the complement clause. As in simple clauses, in bi-clausal contexts, the agreement trigger is either the (downstairs) absolutive subject (18) or the (downstairs) absolutive object (19). Non-absolutive DPs fail to trigger agreement (20).

⁶ All Tsez examples – unless specially mentioned - are from Polinsky and Potsdam (2001).

(18) eni-r [uzi ϕ-ay-ru-li] ϕ-iy-xo.

Mother-dat. [boy.I.abs. I-arrive-pstprt.nmlz] I-know-pres.

‘The mother knows the boy arrived’

(19) eni-r [uz-a magalu b-ac-ru-li] b-iy-xo.

mother-dat. [boy-erg bread.III.abs. III-eat-pstprt.nmlz] III-know.pres.

‘The mother knows the bread, the boy ate’

(20) *eni-r [uz-a kidbe-r magalu taλ-ru-li] y-iyxo.

Mother-dat. [boy-erg. girl.II-dat. bread.abs. give-pstprt-nmlz.] II.know.

‘The mother knows that the boy gave the girl bread.’

Agreeing DPs are always interpreted as topics (i.e. as elements already identified in the preceding discourse) and may surface either inside the embedded clause (19) or at its edge (21).⁷ The agreement trigger need not however, be obligatorily marked with the topic marker *-n/-gon*, though the presence of a topic marker ensures obligatory LDA (see (22)).⁸

⁷ Anaphors and certain quantifiers do not carry overt topic markers (i)-(ii). They may nonetheless trigger class agreement (iii).

(i) zed-a zeda zedu-r-(*gon/no) yutku rodin.

They-erg. themselves-dat-(*top) house made.

‘For themselves, they build a house’

(ii) zek’u-za-r shebin-(*gon/no) r-aq’-inci.

Man-pl-dat. nothing.IV.-(*top) IV-be-fut.neg.

‘People will get nothing’

(iii) [Irbahin-er-no ?ali-r-no]-i [zeda zedu-i goyi-z-anu-si-li] b-iyxo.

Ibrahim-dat-and Ali-dat-and each other.abs.I.pl. invite-pres.neg.prsprt.nmlz]-I.pl.-know-pres.

‘Ibrahim and Ali know that they have not invited each other’

⁸ Focused absolutive DPs trigger agreement on the lower clause, but fail to trigger cross-clausal agreement (see below for more discussion).

(i) eni-r [t’ek-kin y-igu yal-ru-li] r-iy-xo.

mother-dat [book.II.abs.foc. II-good be-pstprt.nmlx].IV IV-know.pres

‘The mother knows that the book is good’

(21) eni-r [magalu uz-a b-ac-ru-li] b-iy-xo.
 mother-dat. [bread.III.abs. boy-erg III-eat-pstprt.nmlz] III-know.pres.
 ‘The mother knows, the bread, the boy ate’

(22) enir [uz-a magalu-n/magalu-gon b-ac-ru-li] *r/b-iy-xo.
 Mother boy-erg. bread.III-abs-top III-eat-pstprt-nmzl]. *IV/III-know-pres.
 ‘The mother knows that the bread, the boy ate’

Observe that in all instances of LDA discussed so far, the embedded verb is also marked for object agreement (18)-(19) and (21)-(22).⁹ Embedded verbal agreement is however not ‘parasitic’ on the matrix verb and exists independently of LDA. To see this, consider the agreement patterns in the following sentence:

(23) eni-r [uz-a magalu b-ac-ru-li] r-iy-xo.
 Mother-dat. [boy-erg. bread.III.abs. III-eat-pstprt-nmlz.]-IV IV.know-pres
 ‘The mother knows the boy ate the bread’

Cross-clausal agreement is optional and the matrix predicate sometimes agrees with its CP-complement. The sentence in (23), for example, shows the matrix verb reflecting class-IV morphology of the complement clause instead of the ‘expected’ class III

(ii) *eni-r [t’ed-kin y-igu yal-ru-li] y-iy-xo
 mother-dat. book.II.abs.foc. II-good be-pstprt.nmlz II-know-pres.
 ‘The mother knows that the book is good’

⁹ Agreement morphology is not reflected on certain verbs owing to some morphophonemic idiosyncrasies of the language.

morphology of the embedded-clause argument.¹⁰ While the matrix verb agrees with the clausal complement in (23), the embedded verb retains class III-agreement, suggesting that it has independently entered into phi-agreement with the absolutive object. Embedded agreement is therefore not ‘parasitic’ on matrix agreement in Tsez, unlike what we observed with Hindi-Urdu, Kashmiri and Chamorro LDA constructions in the preceding chapter. Embedded verbs in Tsez must therefore be non-defective and capable of assigning structural case to their objects.

Another important point to note with regard to the example in (23) is that clausal agreement is not contingent on the presence of an overt complementizer. The matrix verb agrees with the clause even when a complementizer is evidently not present. However, when there is an overt complementizer in the structure, clausal agreement becomes obligatory, ruling out LDA as (24) shows:

- (24) eni-r [uz-a magalu b-ac-ru-l] r/*b-iy-xo.
 Mother-dat. boy-erg. bread.III.abs. III-eat-pst.evid-COMP IV/*III-knows
 ‘The mother knows the boy ate the bread’

From the contrast between examples (18)-(19)/(21)-(22) and (23)-(24), I conclude along with Polinsky and Potsdam (2002) that complements in LDA structures are obligatorily TPs that are not selected by (overt/covert) C-heads. CP-complements impede LDA in this language (though see later sections for evidence of agreement across CP-boundaries from

¹⁰ Class IV agreement is also default agreement.

other languages). In addition to these two clause types, Tsez also has infinitivals that are marked with the morphological suffix *-a*. Consider:

(25) doxtur [PRO malim ϕ -egir-a] r?u λ 'i-x.

doctor-abs. teacher-abs. I-send-inf. threaten-pres.

‘The doctor threatens to send the teacher’

Infinitivals such as those in (25) are different from LDA TP-complements on two accounts. First, they fail to license overt subjects. The absence of an overt subject in infinitivals, I claim correlates with the absence a phi-complete T capable of licensing structural case. But they include a non-defective *v* that assigns structural absolute to objects as they evidently get case-marked with absolute and also control verbal agreement. A second difference between these two sentence types is briefly alluded to by Polinsky and Potsdam (in footnote 11) where they state that infinitivals under one or two-place auxiliary/predicates like *be-good*, *be-able* or *want* behave like mono-clausal structures and force obligatory cross-clausal agreement. Unfortunately, there is no data provided to corroborate the claim, so I will simply follow them in assuming that infinitivals form part of the main-clause in Tsez, whereas LDA TP-complements under consideration here don't. The latter – as will be demonstrated shortly – have none of the characteristics of mono-clausal structures. A final difference between LDA with infinitivals and LDA across TP-complements is that agreement triggers in the former are not interpreted as topics. Once again, this claim is not supported with examples.

Summing up, the following picture emerges for Tsez LDA constructions. Complement clauses of Tsez LDA sentences are neither CPs nor infinitivals. They are instead TPs that fail to be selected by a C head. From what we have seen so far, there is very little ground to believe that these TPs lack functional heads or eligible structural case checkers for their arguments. The presence of overt embedded subjects, I claimed, correlates with the presence of a non-defective T-head in the downstairs clause. In a similar vein, objects are also licensed inside these clauses, against a non-defective verbal head. Finally agreement triggers are always embedded topics.

Additionally, there are some constraints on the generation of LDA. We have already seen that complementizers block LDA. This is however, not the only context where LDA is blocked. LDA is also absent in structures with wh-phrases (irrespective of their argument/ adjunct status). Take (26) and (27) for example. Both sentences have a wh-phrase placed at the left periphery of the embedded clause and both disallow embedded objects from controlling matrix agreement. On the assumption that embedded wh-phrases target the specifier of embedded CP, I take these cases to confirm that a CP boundary makes the lower arguments inaccessible to higher heads.

(26) enir [lu micxir b-ok'ak'-ru-li] r/*b-iyxo.

Mother who-erg money.III.abs. III.steal-pstprt-nmlz.] IV/*III-knows.

‘The mother knows who stole the money’

(27) enir [na c'ohor-a micxir b-ok'ak'-ru-li] r/*b-iyxo.

Mother where thief-erg. money.III. III-steal-pstprt-nmlz IV/*III-knows.

‘The mother knows where the thief stole the money’

Embedded adverbials topics also prohibit LDA, as illustrated in (28). Note that only raised adverbials may intervene; in-situ adverbials as in (29) do not block agreement.

(28) eni-r [hul uz-a magalu b-ac-ru-li] r/*b-iy-xo.

Mother yesterday boy-erg. bread.III.abs. III-eat-pstprt-nmlz].IV IV/*III-knows pres.

‘The mother knows the boy ate bread yesterday.’

(29) eni-r [uz-a hul magalu b-ac-ru-li] r/b-iy-xo.

Mother boy-erg. yesterday bread.III.abs. III-eat-pstprt-nmlz].IV IV/III-knows pres.

‘The mother knows the boy ate bread yesterday’

These two sentences also differ in the interpretation of the adverbial; only in the former is the adverbial conceived as a topic. Adverbial topics generally target higher positions in Tsez, as we also see in the mono-clausal structure in (30).

(30) ishkolayor uza-a k’et’u begirsi

to.school boy-erg cat.abs. sent

‘To school, the boy sent the cat’

Polinsky and Potsdam suggest that the canonical landing site for topics (both argument and adjunct) is the specifier of TopicP, placed below a CP. We can therefore find structures like (31) where topics obligatorily follow wh-phrases. As expected, the inverse

order in (32) is bad. Notice that raised topics precede their subjects, which indicates that topics target a position higher than TP, on the assumption that the specifier of TP is the canonical landing site for Tsez subjects too.

(31) nar elude-r(no) za nex-xo.

Where we-dat(-top) he-abs. approach-pres.

‘Where will he approach us?’

(32) *elude-r(-no) nar za nex-xo

we-dat(-top) where he-abs. approach-pres.

‘Where will he approach us?’

To summarize, the mono-clausal scenario on topicalization is as follows. Topics in Tsez are licensed in the specifier of TopicP. Secondly, TopicP is selected by a CP, evidenced by the co-existence of topics and *wh*-phrases in the same structure. With respect to bi-clausal structures, it is obvious that adverbial topics raise to the clause edge, but it is less clear if their landing site is the specifier of CP or TopicP. If we assume that it is the latter, we must still posit a CP above it, going with the general observation that embedded topics usually force overt complementizers across languages. Or to put in other words, topic phrases cannot serve as complements to matrix predicates. We borrow the following English example from Den Dikken (2005) to illustrate the point.

(33) I believe *(that) Bush, I could never take seriously.

If the same generalization holds for Tsez, then there is a straightforward answer for why embedded adverbial topics block LDA. Their presence is symptomatic of embedded CPs (with overt/covert C) that typically pose as barriers to agreement in the language. As is obvious, this cannot be the complete picture for topicalization in Tsez. If embedded argument topics are also licensed against TopicP contained in CP structures, there is no explanation for why absolutive (or argument) topics trigger obligatory LDA (see the example in (22) again). Given that the evidence adduced so far shows CPs as boundaries to agreement, we incorrectly predict these topics to be always barred from triggering cross-clausal agreement. An analysis for these facts is left pending for the moment, but it is worth mentioning at this point that if I am right about Tsez clause structure, then adjunct and argument topicalization in embedded contexts must be derived via different mechanisms. While the former is licensed in the usual topic-configuration, Tsez seems to employ a different mechanism for the latter. My contention is that once this mechanism is revealed, a better understanding of how LDA takes place in the language will emerge automatically.

In any case, adverbial topics are not the only interveners. Polinsky and Potsdam also present evidence suggesting that non-absolutive argument topics also induce intervention (34). Our discussion so far points towards two possible scenarios: (a) non-absolutive topics are licensed by a TopicP, in turn selected by C, and CPs bar LDA, or (b) they vie for the same position targeted by absolutive topics. I suspect that (b) is the correct way to go for the following reasons. First, there are no cases of multiple argument topicalization in embedded contexts cited by Polinsky and Potsdam. Second, instances of CP-

complements (with overt complementizers) hosting non-absolute argument topics are also missing. I take this to suggest that embedded argument topics are never attested inside CP-complements in Tsez and there is a single position in the matrix clause that hosts an embedded topic, which explains the ban on multiple embedded argument topics.

(34) eni-r [ah-a canaqan-go-gon ziya bisr-er-xosi-li]

Mother-dat. shepherd-erg. hunter-poss.ess-top cow.III.abs. feed-caus-prtpst-nmlz].IV
r/*b-iy-xo.

IV/*III-know-pres.

‘The mother knows that the hunter, the shepherd made (him) feed the cow.’

The final blocking effect arises in the context of adjuncts. This is shown in (35) where the argument (*girl*) of the adjunct clause fails to trigger class-II agreement on the matrix predicate.

(35) [kid y-ay-zal] enir xabar r/*y—esu-s.

girl.II.abs. II.arrive-when mother-dat news.IV. IV/*II-find-pst.evid.

‘When the girl arrived, the mother found out the news’.

To summarize the main points in this section, we have seen that Tsez cross-clausal agreement is triggered by absolute DPs ‘embedded’ in clausal TP-complements. Overt complementizers, adjuncts, wh-phrases, adverbial and non-absolute topics impede cross-clausal agreement. LDA-triggering DPs are also essentially interpreted as topics.

With this background information, let us now turn to discuss some facts that direct us to the structural location of the agreeing DPs.

3.3 The position of the agreement trigger

There are three pieces of evidence given in Polinsky and Potsdam (2001) suggesting that the agreement trigger never leaves the embedded clause. The first proof for an embedded clause position comes from constituency tests.

(36) enir b-iyxo [uza magalu bac'ruli]
 mother III-knows boy bread.III. ate

 'The mother knows the boy ate the bread'

(37) [uza magalu bac'ruli] enir b-iyxo
 boy bread.III. ate mother III-knows

 'The mother knows the boy ate the bread'

As shown in (36)-(37), the agreement trigger can be moved along with the rest of the embedded clause. This implies that it remains part of the lower clause. The acceptability of these sentences is hard to explain, if we alternatively suggested that the trigger had moved outside the embedded clause.

The second piece of evidence for an embedded clause position comes from a comparison of scope patterns in LDA constructions with those found elsewhere in the language.

Polinsky and Potsdam observe that inverse scope is always a possibility in the language. Take the following examples, for instance.¹¹

(38) shibaw y?^way-a sis k'et'u han-si
every boy-erg one cat-abs. bite-pst.evid.
'Every dog bit a cat'

every dog > a cat

a cat > every dog

(39) sida y?^way-a shibaw k'et'u han-si
one-oblique dog-erg every cat-abs. bite-pst.evid.
A dog bit every cat'

A dog > every cat

Every cat > a dog

As shown in (38)-(39), Tsez allows ergative subjects to reconstruct to their base-generated position (namely, the inner specifier of vP) and scope below absolutive objects that move to the outer specifier of the same projection for case. Availability of inverse scope readings among clause-mate nominals in the language leads us to expect the following. If long-distance agreement triggering DPs move over to the matrix clause, they must be allowed to scope over their clause-mate matrix subjects. Assuming that the former target the outer specifier of main clause vP, they may c-command matrix subjects in their reconstructed positions and can consequently scope over them. However, the

¹¹ Maria Polinsky (personal communication) informs me that Tsez does not have an independent morpheme for 'some', which is why the above sentences – that are not the most ideal ones to find inverse scope – have been constructed with the determiner 'a' and universal quantifier 'every'.

available data contradicts our expectations. Agreement triggers, as the LDA sentence in (40) shows, must always scope below matrix subjects.

(40) sis uciteler [shibaw uzi ϕ -ki'ixosi-li] ϕ -iyxo.

One teacher every boy-I.abs. I-go-nmlz I-know.

'Some teacher knows that every boy is going'

some teacher > every boy

*every boy > some teacher

LDA (40) and non-LDA structures (41) pattern alike in this regard; both forbid embedded arguments to scope over main clause arguments.

(41) sis uciteler [shibaw uzi ϕ -ik'ixosi-li] r-iyxo.

One teacher every boy.I-abs. I-go.nmlz. IV-know.

'Some teacher knows that every boy is going'

Some teacher > every boy

*Every boy > some teacher

A last piece of evidence for an embedded clause position for the agreement trigger comes from structures like (42). As illustrated, cross-clausal agreement is restricted to the next clause up. An argument of the most deeply embedded clause can trigger class agreement on the immediately higher verb. The highest verb in turn displays the class morphology of its complement clause.

(42) babir [enir [uza magalu bac'ruli] b-iyxosi-li] r/*b-iyxo.
 Father mother boy bread-III.abs. ate III-know-nmlz. IV/*III.know.
 'The father knows that the mother knows the boy ate bread'

Notice that if we were to assume that the DP moves out of its base-generated position, Tsez would, incorrectly, allow the highest verb in (42) to reflect class-III agreement. Once the DP moves out to the second highest clause, there is no reason, as Polinsky and Potsdam point out, for why it must not cross over to the highest clause.

The evidence presented in this section is therefore suggestive of a long-distance agreement relation between a matrix head and the argument of its complement clause. Since the agreement trigger is clearly inside the domain of the lower clause, the most obvious conclusion is that Tsez cross-clausal agreement ensues between a head and an argument that fails to become its sister at any point of the derivation. These facts have led previous authors (Polinsky and Potsdam 2001; Bhatt 2005; Boskovic 2005) to resort to the operation Agree to explain the generation of LDA. I devote the next section to a critical reassessment of these studies, along with some more 'local' alternatives.

3.4 Previous Reflections: A Critique

Existing literature on Tsez LDA can be broadly divided under two camps; those that vouch for a long-distance Agree relation (Polinsky and Potsdam 2001; Bhatt 2005;

Boskovic 2005) and those that propose more local alternatives (Frank 2005; Koopman 2005; Chandra 2006; 2007). I start with a summary and critique of the first approach.

3.4.1 The tale of the Agree-adherents

Agree-based accounts for Tsez LDA can be further divided into two sub-groups. The first group contends that agreement triggers must be at the edge of the complement clause of the checking head (cf. Polinsky and Potsdam 2001; Bhatt 2005).¹² On the other end of the spectrum are those approaches (Boskovic 2005) that allow placing an agreement trigger many clauses away from the checking head, as long as there is no intermediate element with a set of phi-features that could trigger the same operation. Below, I unpack each of these approaches.

3.4.1.1 Polinsky and Potsdam (2001)

Polinsky and Potsdam (2001) start their investigation of Tsez LDA with the following generalization (43), which they claim is “a useful probe on the syntax of LDA.”

(43) Topic Condition on Long-Distance Agreement [TCLDA]

LDA occurs when the referent of the embedded absolutive NP is the (primary) topic of the embedded clause.

¹² Recall from the previous chapter that Bhatt (2005) allows the object trigger in Hindi-Urdu to remain in its base-generated position while triggering agreement with matrix T. He installs the extra mechanism of co-valuation to trigger indirect agreement with an intervening tense head. I will overlook the internal consistencies of Bhatt’s system here.

The TCLDA bears on two observations that have already been alluded to in prior sections: (i) the agreeing nominal is always interpreted as a topic, and (ii) LDA is obligatory when the absolutive nominal has an overt topic marker. Clubbing these two observations together under (43), Polinsky and Potsdam then use it to propose (45) as the underlying representation for structures like (44).¹³

- (44) *eni-r [uz-a magalu b-ac-ru-li] b-iy-xo.*
 mother-dat. [boy-erg bread.III.abs. III-eat-pstprt.nmlz] III-know.pres.
 ‘The mother knows that the boy ate the bread’

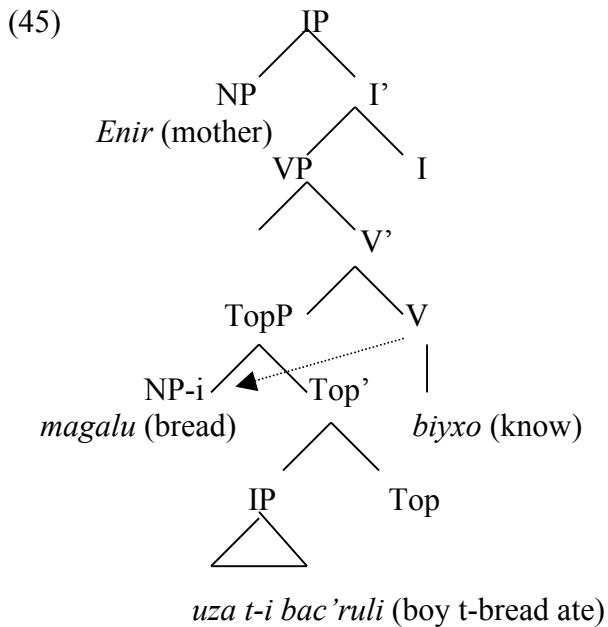

In (45), the agreeing nominal covertly targets the specifier of TopicP that immediately dominates the lower IP. Object movement to the clause-edge position is A-bar movement, driven by a topic feature on the moving element. Once there, the topic is close

¹³ As for why only absolutive DPs trigger cross-clausal agreement, Polinsky and Potsdam contend that this “is simply because verbs only show agreement with absolutive arguments.” (p. 286).

enough to matrix *v* to agree (long-distance) with it. Therein ensues cross-clausal agreement in Tsez between a matrix head and the topic of its complement clause. There are two important aspects in Polinsky and Potsdam's account worth reiterating at this point. First, in their understanding, agreement in (45) is agreement with an A-bar element (the topic in this instance). This makes Tsez LDA an instance of A-bar agreement, which is crucially not tied to structural case-checking. The second crucial point in their analysis is that the agreement trigger can target the specifier of TopicP at LF. This implies that phi-agreement is also covert, since it is rendered possible only after covert topicalization. Covert topicalization provides an easy explanation for why agreement triggers do not necessarily surface at the edge of the embedded clause. Since topicalization is covert, Tsez pronounces the agreement trigger in its base-generated embedded VP/vP-internal position. Utterances, where the topic actually surfaces at the edge of the downstairs clause, are in turn derived either by overt topic movement or by scrambling to the edge of the lower clause. Significant for Polinsky and Potsdam is the idea that covert topicalization does not target a position outside the clause. If it did, there remains no way of accounting for the obligatory narrow scope of the agreement trigger vis-à-vis the matrix subject or the former's inability to trigger phi-agreement across multiple clauses. Notice that a similar constraint must be placed on overt topicalization and scrambling as well. If topics could move overtly across two or more clauses, we incorrectly predict LDA all the way up to the highest clause. Interestingly, the ban on cross-clausal movement is not unique to topics in LDA constructions. There is a general ban on long-distance A-bar extraction in the language. The unacceptability of (46) – where a wh-

phrase illicitly targets the specifier of CP across two clause-boundaries – bears testimony to this general character of Tsez.

- (46) *sebi enir riyxo [c'ohora rok'ak-ru-li]
 what.abs. mother knows thief-erg. steal.pstprt.nmlz.
 ‘What does the mother know that the thief stole?’

Polinsky and Potsdam then resort to the notion of ‘barriers’ (Chomsky 1986b) to explain the intervention effects due to overt complementizers, embedded wh-phrases and non-absolute argument and adjunct topics. The presence of overt complementizers and wh-phrases correlates with the presence of a CP (between matrix vP and embedded TopicP). They contend that either C is a possible governor or that one or more of CP and TopicP is a barrier for head government. On the other hand, fronted adverbial-topics and overtly topic-marked nominals occupy the specifier of TopicP, usurping the landing site for the agreeing nominals. Their account, as they acknowledge must rule out the alternative LF representation where the trigger’s (covert) movement precedes the (covert) movement of the non-absolute topic; i.e. the non-absolute topic must necessarily move before the absolute nominal can target the edge of the phrase.

A more careful investigation reveals some serious loopholes in Polinsky and Potsdam’s account. The first problem lies in their claim that topic movement is (sometimes) covert in the language. As Boskovic (2005) rightly points out, covert topicalization is not commonly attested in natural language, so why Tsez must be allowed this option is not

immediately clear. This issue is also symptomatic of a deeper problem that also goes unnoticed by Boskovic. As widely accepted, covert movement is insensitive to islands (Huang 1982; Lasnik and Saito 1992)¹⁴ Assuming this to be right, topicalization – if covert in Tsez – must be insensitive to islands too. However existing data contradicts this prediction¹⁵:

(47) *uz-a [ya yedu t'ek-gon/no ya yedu gaziyat] t'et'ersi.

Boy-erg or this book-abs.top or this newspaper.abs. read.

'The boy read this book or this newspaper'

(48) uz-a [ya yedu t'ek-gon/no ya yedu gaziyaat-gon/no] t'et'ersi.

Boy-erg. or this book-abs.top or this newspaper-abs.top. read.

'This book or this newspaper, the boy read'

Sentence (47) is unacceptable with only one of the conjuncts of the DP-object bearing an overt topic marker. This result is expected if topicalization is overt in the language: moving one of the conjuncts out of the object DP violates the co-ordinate structure

¹⁴ The Chinese examples taken from Huang (1982) show that argument DPs are insensitive to islands.

(i) [shei xie de shu] zui youqui?

Who write de book most interesting

'Book that who wrote is the most interesting?'

(ii) [ta taolun sheme de shu] zui youqu?

He discuss what DE book most interesting

'Books in which he discusses what are most interesting?'

Compare these to the unacceptable English questions in (iii) and (iv).

(i) *Who are the books that wrote the most interesting?

(ii) *What are the books in which he discusses most interesting?

¹⁵ Unfortunately, I do not have the relevant data with strong islands like CNPC.

constraint, though topicalizing the big DP containing both conjuncts is perfectly fine (see (48)).¹⁶

A different problem for covert topicalization followed by phi-agreement comes from the standard minimalist assumption that LF operations do not feed surface forms. If the matrix verb receives the phi-value of the topic at LF, under standard accounts that have no way of linking PF and LF outputs, it remains unexplained how the verb comes to bear overt class morphology of the embedded argument. Note that this problem arises only when feature checking is substituted by feature valuation. If one assumes that heads are endowed with features that must be checked during the course of the derivation, the issue of whether the actual checking takes place in overt or covert syntax is orthogonal to the present discussion.

Additionally, as also pointed out by Boskovic, Polinsky and Potsdam's account forces covert computations to exist alongside long-distance Agree that was originally intended to replace the former. Agree in overt syntax allows feature-checking to take place without actual movement, therefore producing the same surface effects as feature-checking at LF, which once again have no PF implications. Though it is perfectly possible for two different mechanisms to overlap in their functions, a theory positing both of them at least has the onus of justifying their co-existence in the grammar.

¹⁶ If (47) involves overt topicalization out of the coordinate structure, which leads to its unacceptability, I will have to assume that the copy of the raised topic inside the island is spelled out.

Another problem with their account is worth reiterating here. Their claim that Tsez LDA is triggered from A-bar positions makes one wonder why the language should not allow cross-clausal agreement with other A-bar elements (as for instance, focused arguments). To illustrate with an example, focused phrases in sentences like (49) cannot trigger class-agreement on the matrix predicate, even when they are (i) case-marked absolutive and (ii) occupy the edge of the downstairs clause. The matrix verb displays obligatory class-IV agreement in such cases (50). What makes these cases more interesting is the fact that focused phrases are agreement triggers inside the TP-complements of these sentences. They also control agreement in simple, impersonal clauses (51), which typically resist topics (52).

(49) *eni-r [t'ek-kin y-igu yal-ru-li] y-iy-xo.
 Mother-dat. [book.II.abs-foc. II-good be-pstprt-nmlx]. II.know.pres.
 ‘The mother knows that the BOOK is good’.

(50) eni-r [t'ek-kin y-igu yal-ru-li] r-iy-xo r-iy-xo.
 Mother-dat. [book.II.abs-foc. II-good be-pstprt-nmlx],IV. IV.know.pres.
 ‘The mother knows that the BOOK is good’.

(51) isi y-egir-xo.
 Snow.II.abs. II-send-pres.
 ‘It is snowing’

(52) *isi-n/isi-gon yegir-xo.
 Snow-no/snow-gon. Send-pres.
 ‘It is snowing’

One could extend the argument to *wh*-phrases, which Polinsky and Potsdam explicitly rule out from the list of agreement triggers. Consider the unacceptable (46) once again. This sentence is ruled out for violating the ban on long-distance A-bar extraction. However, what is interesting and more relevant for our immediate purposes is that the matrix verb carries class-IV morphology, the canonical clausal or default agreement.¹⁷ *Wh*-phrases fail to trigger cross-clausal agreement, an unexpected result if LDA is indeed agreement triggered from A-bar positions. Since *wh*-phrases move (overtly or covertly) to the specifier of the complement CP, there is no straightforward way of ruling out agreement with them. The puzzle is heightened by constructions like (53).

- (53). enir [shebi y-ak'i-ru-li] y-iy-anu
 mother *wh*-II.abs. II-go-pstprt-nmlz II-know-pres.neg.
 'The mother does not know who [of women] left'

In (53), a d-linked *wh*-phrase can trigger class-II agreement on the verb across the embedded clause. Polinsky and Potsdam suggest that these phrases occupy the specifier of CP, which makes them eligible candidates for cross-clausal agreement. What they do not explain however, is how and why non-d-linked phrases, that also presumably occupy the specifier of embedded CP, are barred from triggering agreement on the higher verb.

¹⁷ It is hard to glean from structures like (i) if *wh*-phrases trigger agreement in simple clauses.
 (i) Shebi uz-a ishola t'et'erro
 What-abs. boy-erg. in school reads
 'What does the boy read in school?'

3.4.1.2 Bhatt (2005)

Bhatt's (2005) analysis for Tsez LDA shares some of its core ingredients with Polinsky and Potsdam's account and thereby inherits some of the shortcomings of the parent study. However there are also some non-trivial differences between these two accounts that deserve some attention here. Bhatt, for instance, formally recognizes the Agree relation where case-marked nominals remain active for phi-computations as AGREE (see chapter 2 for details). AGREE absolves him from considering LDA as an instance of A-bar agreement. Moreover, while Polinsky and Potsdam must resort to covert topicalization, Bhatt motivates it by positing intermediate interveners. Below is a brief sketch of how the derivation proceeds in his system.

Once matrix T (the probe/locus for agreement in Bhatt's system) is introduced into the derivation, it sets out to find an appropriate goal against which it may check its phi-features. The absolutive object is a potential goal, but there are two other potential interveners in the path leading to matrix T: (i) the embedded ergative subject and (ii) embedded finite T. The first, i.e. the ergative subject, Bhatt contends, could not possibly defectively intervene as it is overtly case-marked which causes it to become invisible to probes. So the object could agree with T across the ergative subject. The real threat instead comes from embedded T, as schematically represented below in (54).

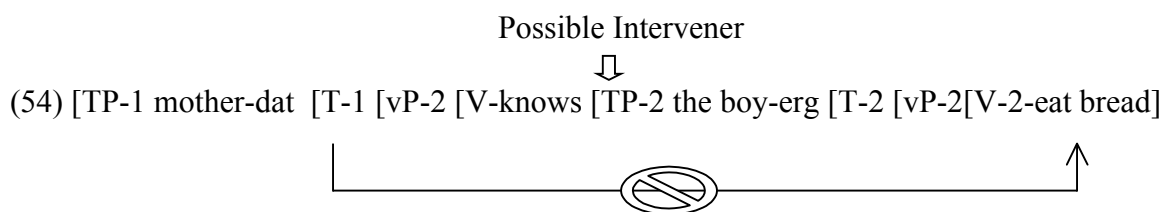

This problem is overcome by moving the object to the specifier of an embedded TopicP placed above TP. Intermediate T then ceases to be a potential intervener, allowing matrix T to agree with the covertly raised object (55).

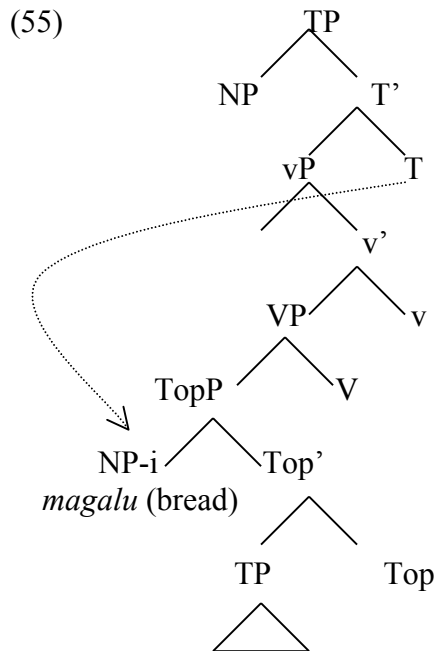

Other than the problems posed by covert computations, Bhatt's account also suffers from its own technical fallacies. One immediate concern is his rather loose treatment of the term 'interveners'. While on the one hand, ergative subjects by virtue of being overtly case-marked are not recognized as interveners, on the other hand, heads (such as embedded T) whose features have already been phi-valued remain active for intervention, even when they are overtly marked with class morphology. Moreover, it is also unclear why matrix heads, V and v do not count as defective interveners in (55). An explanation for why LDA ensues between matrix T and the argument under these conditions is left pending.

3.4.1.3 Boskovic (2005)

A slightly different perspective on Agree – against the backdrop of Tsez LDA – is presented in Boskovic (2005). The gist of Boskovic’s proposal is that Agree has fewer locality restrictions than Move. Agree is not subject to the Phase Impenetrability Condition/PIC (Chomsky 2000), which implies that the goal could in principle, be placed at a significant distance from the probe across many intervening phases. Under this approach, a typical Tsez sentence with agreement between matrix *v* and the embedded object would receive the following representation:

(56) [TP-1 mother-dat [T-1 [v-1 [V-1 knows[TP-2 the boy-erg[T-2 [vP-2[VP-2-eat bread]



The diagram consists of a horizontal line with two upward-pointing arrows. The left arrow points to the 'v-1' element in the matrix clause, and the right arrow points to the 'bread' element in the embedded clause. This indicates that the matrix verb 'v-1' agrees with the embedded object 'bread'.

The trigger or the absolutive object in (56) agrees with the matrix verb (*v-1*) from its base-generated VP-2-internal position. According to Boskovic, there are no potential defective interveners that could impinge phi-agreement between these two elements. LDA is blocked only when an intermediate element or phrase carries similar phi-features. This condition, which Boskovic terms as Agree Closest is the sole locality constraint that Agree obeys. In Boskovic’s analysis, complements containing argument triggers in Tsez are TPs that either do not carry phi-features or if they do carry them, are checked by the subject. This makes the system disregard TPs as potential goals for matrix *v*. In other instances, especially where the embedded clause is a CP (with or without an overt

complementizer) bearing its own phi-set, Agree Closest works to block LDA by ensuring that the verb agrees with the closer CP. Schematically (57):

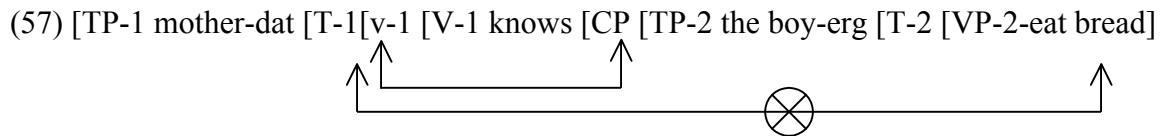

A couple of problems with Boskovic’s analysis are stated as follows. First, his analysis severely undermines the interpretive effects associated with LDA in Tsez. Recall that LDA structures force a topic interpretation for their argument triggers. Cross-clausal agreement becomes imperative when the absolutive DP gets marked with an overt topic marker. The semantics associated with LDA cannot be captured with Boskovic’s Agree Closest condition. Instead, his account predicts that all absolutive nominals, as long as they are not dominated by phrases with similar features, are available for phi-feature checking with the (next) highest head, including focused phrases. I have already presented evidence (see (49)-(50)) contradicting this claim. Tsez focused nominals, which trigger agreement on embedded predicates fail to control agreement across the clause. In addition, Boskovic does not provide an explanation for why clausal agreement is impossible when an absolutive topic occupies the edge of a CP-complement. CP is a closer candidate for agreement and we expect, of course incorrectly, to find structures where the matrix verb agrees with the clause instead of the DP topic that is overtly moved to its specifier.¹⁸

¹⁸ In Boskovic (1997), embedded topics target TP-adjoined positions. But since absolutive subjects can be topics and as well as LDA triggers, it is impossible to adjoin them to the same projection (TP) whose specifier they land at for structural case checking.

To recap, here are the two main ideas that have been proposed for Tsez LDA within an Agree-based framework.

(58)

(i) [TP-1 mother-dat [T-1 [v-1 [V-1 knows [TP-2 bread [TP-2 the boy-erg [T-2 [vP-2 [VP-2eat]]]]]]]]]]]

Diagram (i) shows a hierarchical structure: [TP-1 mother-dat [T-1 [v-1 [V-1 knows [TP-2 bread [TP-2 the boy-erg [T-2 [vP-2 [VP-2eat]]]]]]]]]]]. An arrow points from the head 'knows' to the right edge of the embedded TP-2, and another arrow points from the left edge of the embedded TP-2 to the head 'knows'.

(ii) [TP-1 mother-dat [v-1 [V-1 knows [TP-2 the boy-erg [T-2 [vP-2 [VP-2-eat bread]]]]]]]

Diagram (ii) shows a hierarchical structure: [TP-1 mother-dat [v-1 [V-1 knows [TP-2 the boy-erg [T-2 [vP-2 [VP-2-eat bread]]]]]]]. An arrow points from the head 'knows' to the right edge of the embedded TP-2, and another arrow points from the left edge of the embedded TP-2 to the head 'knows'.

In (i), the agreement trigger must move to the edge of TP-2 in order to remain close to the checking head. Under such an approach, agreement is sensitive to barriers/phases CPs. On the other end is the LDA representation in (ii), under the presumption that Agree is insensitive to the PIC and agreement can be accomplished across intervening phases.

Other than the specific problems that I have already pointed in this section, both approaches have a common problem: they fail to account for why complements pattern like adjuncts in Tsez and disallow long-distance A-bar extraction. Extraction out of complements is cross-linguistically attested. It is therefore rather unusual that some languages like Tsez have complement domains that are impenetrable for movement. As I demonstrate below, some ‘local’ specifier-head alternatives might have an answer to this question, though these too fail as adequate theories for LDA.

3.4.2 A specifier-head alternative

3.4.2.1 Koopman (2005)

Among the possible ‘local’ alternatives that have been proposed for Tsez LDA (Frank 2005; Koopman 2005; Chandra 2006, 2007), Koopman perhaps provides the most restrictive theory for agreement, confining it to specifier-head configurations. Her analysis is founded on the following hypothesis^{19,20}:

(59) Specifier-head hypothesis

If XP agrees with Y, XP is merged with YP, or XP is merged with ZP, which is merged with YP (or XP is merged with WP, which is merged with ZP, which is merged with YP etc).

By (59), possible agreement configurations are restricted to those shown in (60), where a head Y can enter into agreement (depicted by the dotted lines) either with its specifier (i), or the specifier of its specifier (ii) or the specifier of the specifier of its specifier (iii) to all the way down.

(60)

(i)

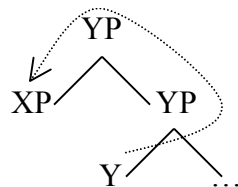

¹⁹ Frank’s (2005) analysis is grounded in the Tree-Adjoining Grammar framework. Some of its basic tenets, it shares with Koopman’s clausal pied-piping analysis.

²⁰ Koopman’s use of the term ‘specifier’ is different from the way I use it in this dissertation.

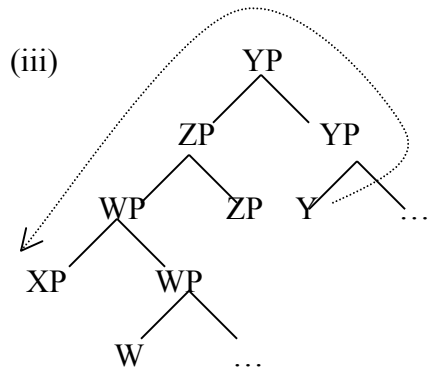
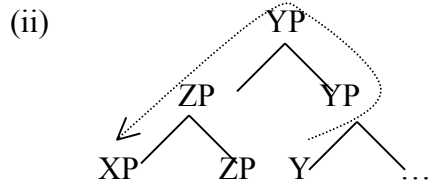

Following are the defining aspects of Koopman’s analysis. First, heads can have only one specifier (or adjunct, which she clubs together with a specifier). Second, agreement is accomplished under pied-piping. An XP has to be in the ‘specifier’ of Y in order to be considered a legible goal for it. Third, agreement applies recursively. XP agrees with head W in (iii) which in turns enters into a specifier-head relation with ZP that itself enters into a specifier-head relation with Y. Recursive feature checking establishes an indirect specifier-head relation between the deeply embedded XP and head Y.

Koopman tries to incorporate the Tsez cross-clausal agreement patterns in specifier-head terms. For LDA configurations with object agreement triggers, she suggests the following underlying representation:

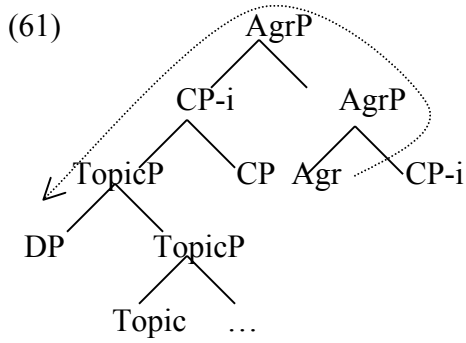

The DP in (61) agrees with TopicP in a specifier-head configuration that is itself an agreeing specifier of CP, which then enters into specifier-head agreement with the Agr head. The features of the lowest DP are therefore carried onto the matrix Agr/verb via recursive specifier-head agreement. Koopman also claims that LDA is blocked under the following circumstances: (a) when the leftmost edge of CP is occupied by some other phrase that agrees with a non-absolute DP, a focused or wh-phrase, and (b) when Agr selects a C head that cannot agree or is embedded under another D-head. In the first situation, TopicP fails to target the specifier of CP (see (62)). C instead (indirectly) agrees with the non-absolute DP via the intermediary phrase XP. The matrix verb ends up receiving the value of CP or is marked with default agreement morphology.

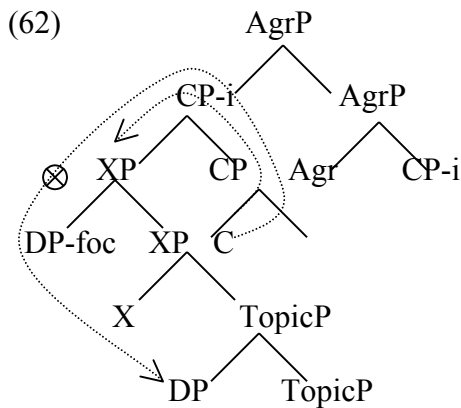

In the second set of circumstances, C either has no features to check or is embedded under DP (*it*) that obligatorily carries class-IV agreement (63).

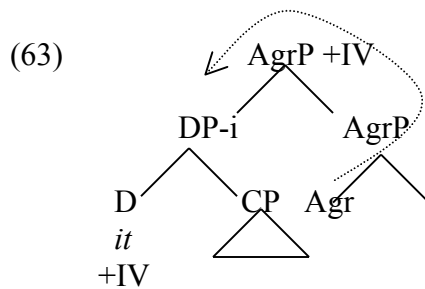

Koopman's work makes no (at least explicit) mention of whether LDA also involves structural case-checking on the topic. Given that she posits a full blown embedded CP-complement in (61), she seems to be implicitly assuming that the absolute topic checks its structural case in the embedded clause. Her account therefore also undermines the Activation Condition. In addition, her account suffers from a couple of technical loopholes that must be highlighted here. The first concerns structural case-checking on the object against *v* in the lower clause. Recall that LDA is accompanied by DP-agreement on the embedded verb, which in Koopmans' terms, can only be accomplished in a specifier-head configuration, i.e. by moving the object to the specifier of lower *v*. However Koopman's system allows a single specifier for any given head. Under standard accounts, the subject is generated in the specifier of *v*P for external theta-role assignment. If *v* has a single specifier, then there is no way that the object can agree with it in a specifier-head configuration, since the subject occupies the sole specifier of *v*P.

Moreover, the absence of multiple specifiers also implies that the object moves (over the subject and its copies in the specifiers of intermediate heads) in one fell-swoop to the specifier of TopicP that then targets the specifier of CP. Note that if C selects TopicP, then Koopman's system forces the latter to move from the complement to the specifier of the same head. In recent literature however (cf. Grohmann 2000, 2003; Abels 2003), such movement is judged illicit by the grammar for being too local. The underlying thesis of these works is that while movement must be local, it must not be too local. Though the definition of 'too local' varies from one work to the other, moving within a single phrase is definitely out for being too local. Koopman's recursive feature-checking theory also fails to prohibit cross-clausal agreement with focused elements in Tsez. If absolutive case-marked elements make to the specifier of CP, then we predict, incorrectly under this approach, that these nominals can indirectly agree with matrix AgrP.

3.4.2.2 Chandra (2006, 2007)

The problem with the Activation Condition – evident in all studies discussed so far – is partially resolved in Chandra (2006, 2007). The gist of this proposal is that TP-complements of Tsez LDA sentences involve defective heads that are incapable of checking structural case on nominals. Embedded subjects and objects cannot be case-licensed in the downstairs clause. Absolutive value(s) on intransitive subjects and transitive objects therefore must come from the higher verb. The chief support for this claim comes from LDA structures with embedded subjects like (64).

(64) eni-r [uzi ϕ -ay-ru-li] ϕ -iy-xo.

Mother-dat. [boy.I.abs. I-arrive-pstprt.nmlz] I-know-pres.

‘The mother knows the boy arrived’

Implicit in this analysis is the assumption that absolutive in Tsez is restricted to functional verbal heads. Hence, it is unexpected that the embedded subject in (64) receives absolutive case internal to the complement clause. On the assumption that unaccusative verbs cannot check structural case, it is contended that absolutive on the subject instead comes from the matrix verb. This is assumed to hold for all internal absolutive arguments, including those in sentences like (65).

(65) eni-r [uz-a magalu b-ac-ru-li] b-iy-xo.

mother-dat. [boy-erg bread.III.abs. III-eat-pstprt.nmlz] III-know.pres.

‘The mother knows the bread, the boy ate’

Further under this account, what has so far been termed as ‘topic movement’ is essentially overt movement to the edge of embedded TP (66), driven by the case-checking requirements of the moving nominal. DP-adjunction to TP is a step of agnostic movement (à la Franks and Levine 2004) that does not fulfill any immediate feature checking requirements on the DP-goal and the T head.

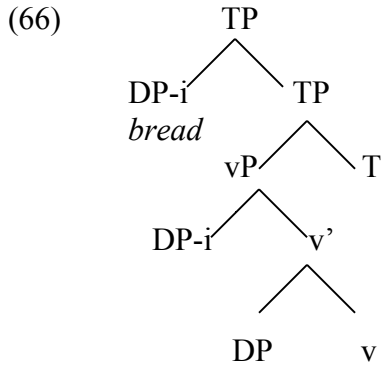

The next assumption is that clausal-complements in Tsez (TPs as well as CPs) undergo obligatory pied-piping to the specifier of the checking (verbal) head. Pied-piping turns the clause into an island (Takahashi 1994; Uriagereka 1999), which explains the clause-bounded nature of A-bar movement in the language. With these two assumptions in place, (i) absolutive topics target embedded TP and (ii) TP obligatorily pied-pipes to the domain of matrix *v*, Chandra posits (67) as the underlying representation for LDA sentences with embedded objects. The embedded object first moves to the specifier of the lower vP, where it checks the (incomplete) phi-features on *v*. This movement places it in the same minimal domain as the lower subject, making them equidistant from a higher goal. The subject then moves to the specifier of TP while the object overtly adjoins to TP (akin to embedded topics, as suggested for some languages by Lasnik and Saito (1991) and Boskovic (1997). DP-adjunction to TP is followed by TP pied-piping to the specifier of matrix vP.²¹

²¹ Notice that once this happens, the DP is in the checking domain of matrix *v*. Checking domain is defined in the sense of Chomsky (1993): the minimal or the smallest subset of the set of nodes – such that every element in the set is reflexively dominated by some element in the subset – *contained* in Max *X* excluding the head and its complement. This notion is however not considered by Chandra (2006, 2007).

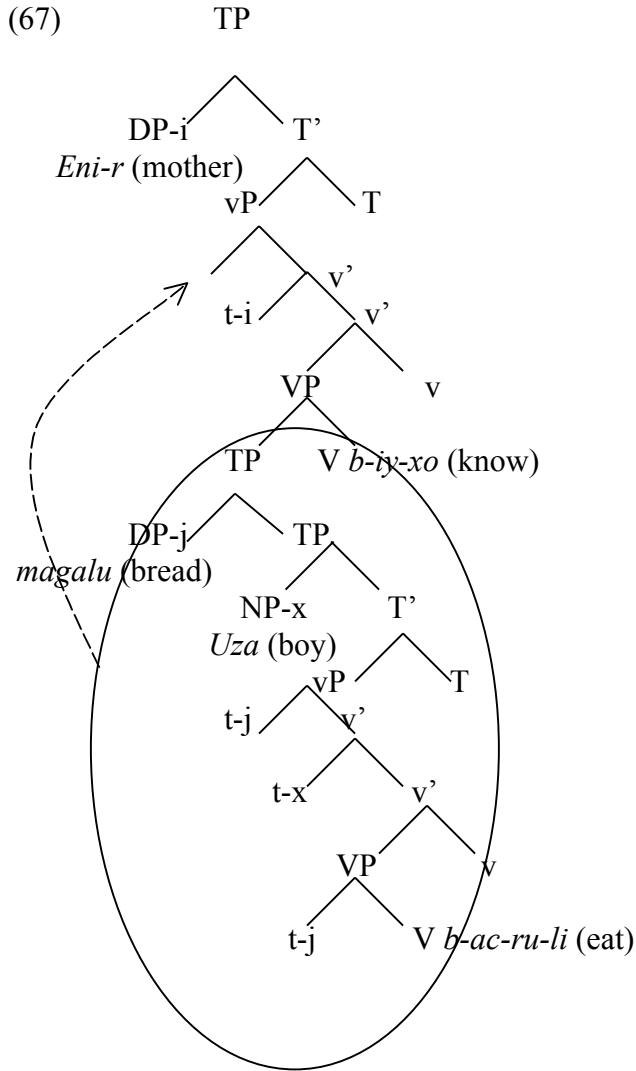

Chandra then suggests DP-reprojection (relabeling TP as DP) as the final step leading to an agreement relation between *v* and the absolutive DP. Reprojection, as proposed by Hornstein and Uriagereka (2002) is simply a process via which a single geometrical object can be accessed from two different vantage points.²² Take the following diagrams for illustration. A single phrase marker when perceived from two different reference points turns out to be two very different objects. What is an XP-specifier to Y in (68) can

²² Crucially for them, reprojection takes place in covert syntax.

also, under reprojection, look like an object labeled XP with YP as the specifier of X (69).

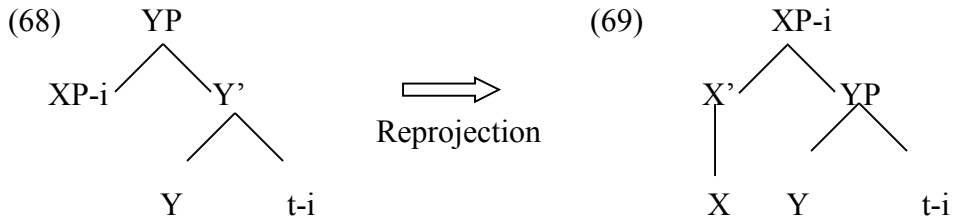

Extending this basic mechanism to Tsez, the TP-adjoined structure in (67), repeated in (70) can also look like a complex DP as in (71).

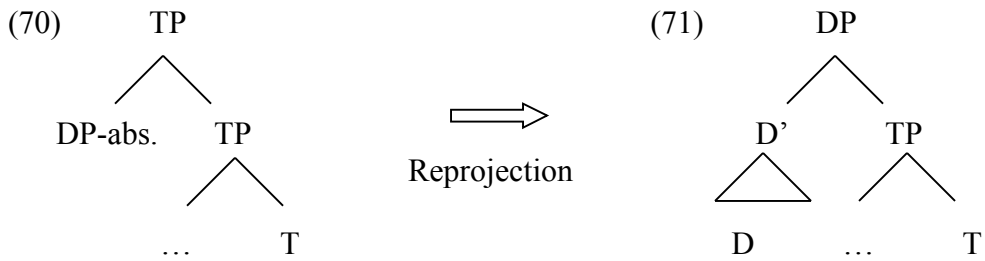

Reprojection allows the absolute DP to be reinterpreted as a sister to matrix v. This relation is local and suited for phi-computations. LDA thereby ensues as in (72), only with one added assumption – that the derivational system allows the same object to be viewed differently from two reference points via the process of reprojection.

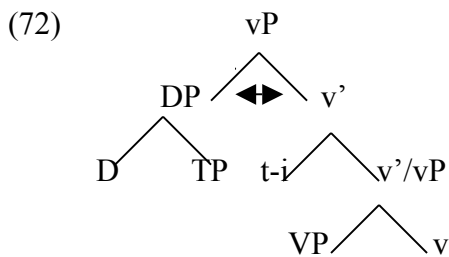

The absence of LDA is taken to imply that the embedded clause is a CP with non-defective heads, which case-check the embedded arguments, eliminating all possibilities of moving them to the matrix clause for phi-feature checking. The rest of the derivation proceeds in the usual way. TP or CP pied-pipes to the domain of vP and agrees with v. The matrix verb consequently reflects class IV morphology.

Chandra's analysis has the following drawbacks. To start, for this analysis to work, it is important that the DP does not receive a case in the embedded clause. This state of affairs is also absolutely necessary to justify reprojection, which under her approach is conceived as a device to erase an illegitimate feature on a nominal. However as I have already noted in preceding discussions (see section 3.2), Tsez LDA complements do not have the typical properties of clauses with defective heads. LDA TP-complements license overt subjects, which is symptomatic of the presence of a case-checking T head. Moreover, the embedded clause can host object agreement, independent of LDA, which indicates that these complements also have non-defective verbal heads capable of assigning structural accusative to their objects. Furthermore, the absolutive case on unaccusative subjects – which forms the main basis of Chandra's defective TP-claim – does not constitute a substantial piece of evidence for defective heads. Intransitive subjects with absolutive case are the norm in languages of the ergative-absolutive ilk. This particular case system is characterized by similar case-marking on transitive objects and intransitive subjects, which suggests the existence of two different heads for absolutive case-checking: transitive v for objects and intransitive T (or v-T combine) for

subjects. Similar patterns are attested in simple clauses too. As shown in (73), the lower verb is an unaccusative and hence, not a structural case-checker. But the subject is still case-marked absolutive presumably by the only other functional head in the structure, namely T.²³

- (73) *ziya* *b-ik'i-s*.
cow.III.abs. III-go-pst.evid.
'The cow left'

Moreover, this analysis cannot be extended to languages like Innu-aimûn where agreement optionally penetrates into finite complements with overt complementizers (details reserved for a later section). LDA sentences in these languages simply cannot be taken as hosting TP-complements with defective functional heads.

In what follows, I present an alternative that upholds the Activation Condition, without stipulating that LDA-complements are defective clauses. More importantly, it can be extended to LDA configurations in several other languages. Let us dub it the 'multiple theta-case' alternative.

3.5 The multiple theta-case alternative

The alternative theory, first of all assumes that every nominal with a theta-role must bear a case-value. This idea can be traced back to the Visibility Condition proposed in

²³ If I are right, Tsez is a member of the absolutive-as-morphological-default language group (Legate 2005).

Chomsky (1986a)²⁴ that dictates that DPs must be assigned case in order to remain visible for theta-role assignment at LF. Technical details aside, what this condition states is that structural case has a vital role to play at the semantic interface, where nominals are evaluated for their interpretive contribution. It can be considered as a mark on the nominal that sets it apart from other arguments in the sentence. Standard minimalism assumes that structural case is deleted from the phrase-marker before it is shipped to LF, with the case value retained specifically for PF-computations. This perspective must be altered once it is assumed that case-values also play a role at the semantic interface. I must now allow case-values to remain on their nominals when they are transferred to the interfaces. Notice that this does not call for any radical adjustment to the existing theory. Case values are insignificant from the perspective of narrow syntactic computations; i.e. they do not reactivate nouns for future phi-computations. Neither do they cause non-convergence at the interfaces, as only unvalued or unchecked cases are illegitimate entities there.

The second, crucial assumption of the alternative analysis is that Tsez LDA structure (74) has (75) as its underlying representation, where the embedded topic *bread* is also the object of the matrix predicate *know*.²⁵

²⁴ Visibility Condition (Chomsky 1986a)

- a) each argument A appears in a chain containing a unique visible theta-position.
 - b) each theta-position is “visible” in a chain containing a unique argument.
- A position P is VISIBLE in a chain if the chain contains a case-marked position.

²⁵ It is also worthwhile noting here the topic marker *no* (which the agreement trigger may or may not carry) is homophonous with the *as for* morpheme in Tsez (see footnote 8 of Polinsky and Potsdam’s paper).

(74) eni-r [uz-a magalu b-ac-ru-li] b-iy-xo.
 mother-dat. [boy-erg bread.III.abs. III-eat-pstprt.nmlz] III-know.pres.
 ‘The mother knows the bread, the boy ate’

(75) The mother knows (about/as for) the bread. The boy ate the bread.

The main motivation behind positing (75) as the underlying representation for Tsez LDA comes from Polinsky and Potsdam’s TCLDA, which I repeat below in (76).

(76) Topic Condition on Long Distance Agreement/TCLDA

LDA occurs when the referent of the embedded absolutive NP is the (primary) topic of the embedded clause.

Assuming the TCLDA to be the correct generalization, I contend, as illustrated in (75), that Tsez LDA sentences are categorical predication forms. In Raposo and Uriagereka’s (1995) terms, in these forms, the topic or the category is ascribed a property by the sentence; i.e. the category is the thing that the sentence is about. Building on similar intuitions, I assume for Tsez LDA, that the agreement trigger, which is an obligatory topic, is predicated with the lower clause. Predication, I will assume, following Williams (1980), requires that the nominal c-command (77) and be c-subjacent (78) to its modifier.

(76) A c-commands B if every branching node that dominates A also dominates B.

(77) A is c-subjacent to B iff B is dominated by at most one branching node which does not dominate A.

These two conditions give two possible configurations for predication: the nominal either asymmetrically c-commands its modifier or they are in a mutual c-command relation. We therefore expect to see topics or categories and their modifying expressions exploiting one of these alternatives. I have already presented evidence (see section 3.2) showing that main clause topics and embedded adverbial topics in Tsez raise as far as the specifier of TopicP, which is in turn selected by a C-head (recall the Den Dikken argument that Topic phrases cannot be selected as complements to matrix verbs). This configuration is ideal for predication; the topic can c-command its modifying expression, the TP from the specifier of TopicP. Schematically²⁶:

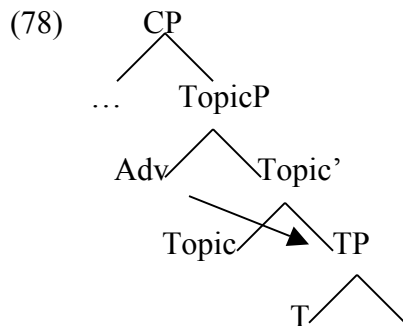

The picture becomes murky once embedded absolutive topics are considered. These topics trigger obligatory LDA but they are incompatible with CPs; i.e. they cannot trigger agreement in the presence of an overt complementizer. Topic Phrases, I have claimed, following Den Dikken, cannot be selected by matrix predicates. The question is then, how does Tsez license absolutive topics of embedded clauses? My answer to this

²⁶ I am assuming that the predication relation is crucial only at the semantic interface. However, syntax must provide the right configuration for it. In other words, the topic and its modifying expression must be in a c-command configuration when the chunk of structure containing them is shipped to the interfaces.

question is that that these topics are not licensed in the specifier of TopicP inside CP-complements; they originate in TPs that lack topic-licensing heads. Moreover, I will assume that the topic and the embedded clause, which is its modifying expression must mutually c-command each other in Tsez. This relation therefore cannot be established by moving the topic to an embedded TP-adjoined position as adjunction fails to create the required mutual c-command relation between the topic and its modifying expression (the entire embedded clause). Tsez instead employs a completely different mechanism to attest argument topicalization in embedded contexts, producing in the process a structure resembling (75), consisting of two different sentences, the first introducing the category or the topic and the second acting as its modifying expression. In what follows, my attempt is to understand this extra topicalization mechanism exploited by Tsez; i.e. how (75) is derived in narrow syntax. There are at least two ways to go about deriving (75); the first is a base-generated small clause analysis and the second is an inter-arboreal or sideward movement analysis.

Let me start with the first approach and assume that the topic is base-generated in the higher clause TP-1 and co-indexed with a pronominal in TP-2. This is represented in (79), where the topic *bread* is introduced as part of a small clause structure, which is selected by an Agr head, itself selected by a D head (ala Torrego and Uriagereka 1995).²⁷

(79) [TP-1 The mother [D [Agr of [SC bread this]]]] [TP-2 The boy ate [pro]-i]

²⁷ Juan Uriagereka (personal communication) points out that this paratactic explanation was noted explicitly by the Venezuelan polymath Andres Bello in his monumental Gramatica Castellana (1847), a century before Donald Davidson recovered the idea in his 1968 classic 'On saying "that"'.

As shown in (79), the idea is that TP-2 substitutes *this* at some point of the derivation, forming a single sentence from two separate clauses. This helps establish the required category-predicate relation between the topic and its modifying clause as the former now becomes sister to the latter. However certain technical loopholes with this approach restrain me from choosing it as the mechanism underlying Tsez embedded topicalization and long distance agreement. Consider in this regard the sentence in (80) with a possible small clause representation in (81).

(80) [Irbahin-er-no ?ali-r-no]-i [zeda zedu-i goyi-z-anu-si-li]

b-iyxo.

Ibrahim-dat-and Ali-dat-and each other.abs.I.pl. invite-pres.neg.prsprt.nmlz]-I.pl-
know-pres.

‘Ibrahim and Ali know that they have not invited each other’

(81) [TP-1 [Ibrahim and Ali]-i know about each other-i] [TP-2 (They)-i have not invited
pro-i]

Tsez is a pro-drop language, which allows it to optionally drop its embedded subject in (80). We depict this with an (optional) overt pronoun for TP-2 in (81). However, observe that this is an illicit structure as it allows the embedded pro-object to be bound in its governing category, therefore incorrectly ruling out (80) for violating Condition B of the binding theory.²⁸ This is shown in the tree diagram in (82).

²⁸ The following examples from Tsez show that pronominals can be A-bound only by non-clause-mate antecedents.

(82)

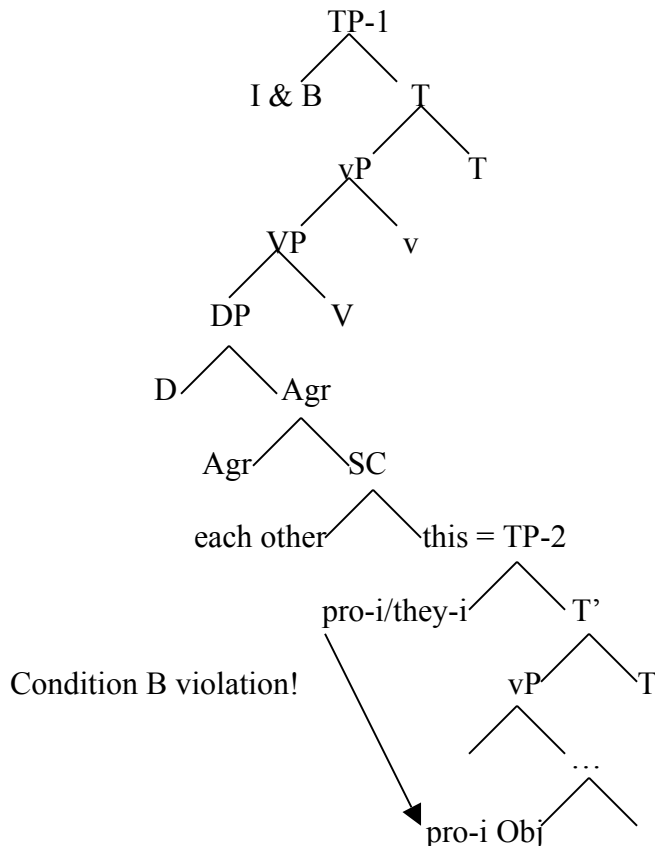

A second reason for rejecting (79) as the underlying representation is that it fails to derive the right word order. Consider an LDA sentence with an overt embedded subject (83), with (84) depicting its underlying representation.

-
- (i) enir [ze Ø-ak'i-ru-li] Ø-iy-xo
mother he-abs. I-go-pstprt-nmlz. I-know-pres
'The mother knows he left'
- (ii) babir [enir [ze Ø-ak'i-ru-li] Ø-iyxosili] r-iyxo
father-i mother he-i I-go-pstprt-nmlz] I-knows IV-knows
'The father knows that the mother knows that he left'

Also see Polinsky and Potsdam (2001) for some more arguments against a similar topic base-generation approach.

(83) eni-r [uz-a magalu b-ac-ru-li] b-iy-xo.
 mother-dat. [boy-erg bread.III.abs. III-eat-pstprt.nmlz] III-know.pres.

‘The mother knows the bread, the boy ate’

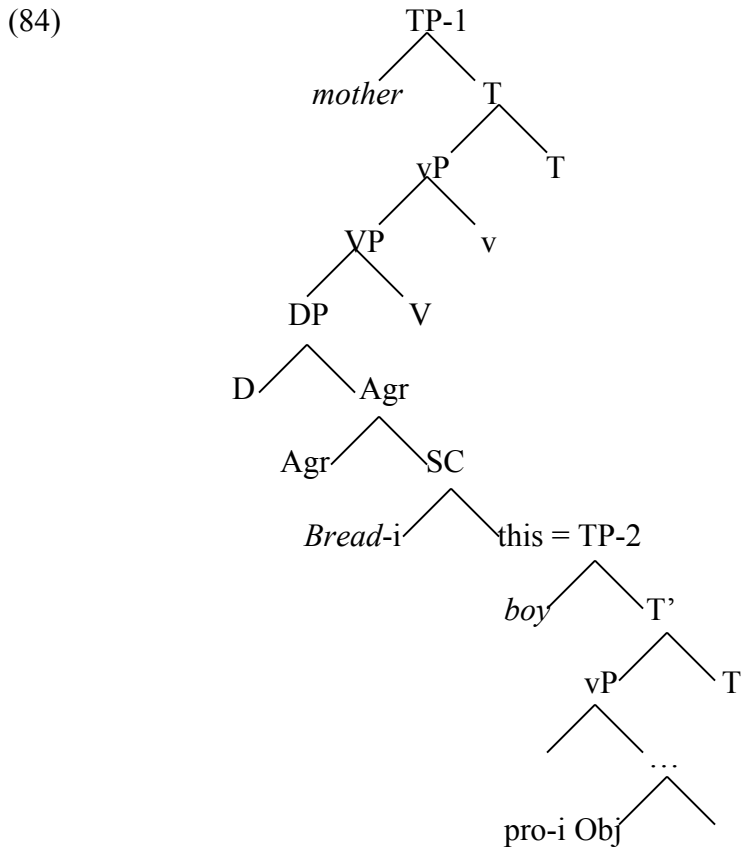

The problem with (84) is that it fails to generate the surface order of (83), with the embedded subject preceding the agreement trigger *bread*. As I have already mentioned, long-distance scrambling across finite clausal boundaries is impossible in Tsez. If the subject cannot scramble out of the lower clause, then there is no straightforward way of deriving an embedded subject-agreement trigger order in the language. In the light of this discussion, I conclude that a base-generation SC analysis is not an optimal solution for

Tsez embedded topicalization and long-distance agreement. I now turn to the second, movement alternative.

I assume firstly that the embedded topic is base-generated as an argument of the embedded clause or TP-2. The relevant steps to its generation are given below in (85).

(85)

(i) [VP-2 V-2 obj]

(ii) [vP-2 obj [subj v-2 [VP-2 V-2 obj]]]

(iii) [TP-2 subj [vP-2 obj [subj v-2 [VP-2 V-2 obj]]]]

(iv) [TP-2 obj[TP-2 Subj [vP-2 Obj [Subj v-2 [VP-2 V-2 Obj]]]]]

The embedded verb selects its internal argument *the bread* in 85(i). The argument then moves over to the specifier of vP in (ii), where it receives an absolutive value for its structural case from v-2. We then build the derivation till (iii), where the subject targets the specifier of TP-2 for case and phi-feature checking. In (iv), the object targets a TP-2 adjoined position. This is a case of agnostic movement and does not involve feature checking. Next, V-1 is introduced into the derivation (see below in 86 (i)). At this point of the derivation, the object (DP-i) of TP-2 is copied and sideward-moved (à la Nunes and Uriagereka 2002) into its complement.

(86) (i)

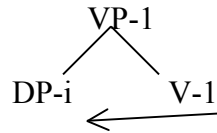

(ii)

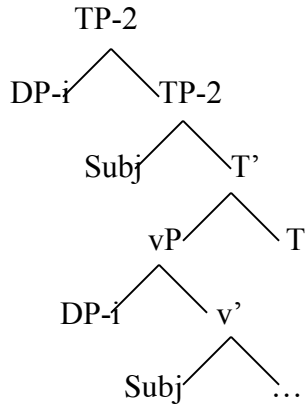

(87)

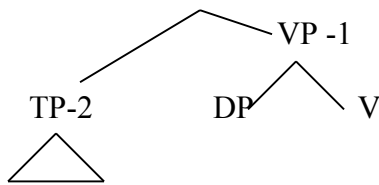

TP-adjunction to VP in (87) creates a label-less structure (à la Chametsky 2000; Uriagereka 2002; Hornstein, Nunes and Pietroski 2005). Note that a predication relation between DP and TP-2 is yet to be established; the former still does not c-command the latter. The system is therefore forced to use DP-reprojection, as shown in (88). Once it reprojects, DP c-command TP-2, satisfying the predication requirement for topicalization. I label the new structure XP, though nothing in my analysis is contingent on it being labeled.

(88)

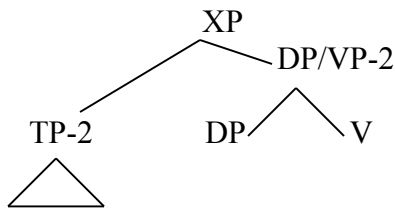

Reprojection, as discussed at length previously, allows the system to perceive a structure from two different vantage points. Therefore even when DP has reprojected, VP remains visible to the computational system. It is then selected by matrix *v*, followed by verb raising to *v* (89).

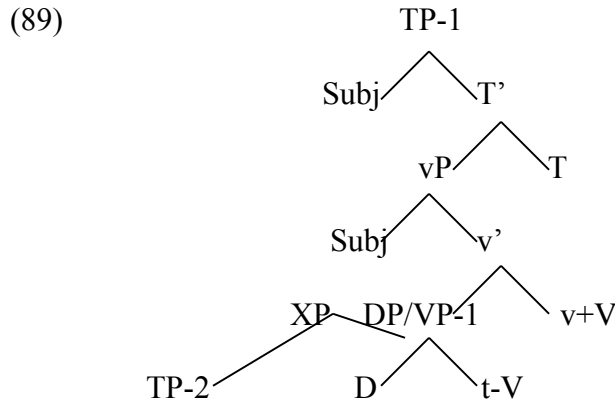

Notice that at this juncture, the reprojected DP is a sister to *v*, which under the alternative proposal is an optimal (and the sole) configuration for agreement. I claim that the embedded topic agrees with *v* in this configuration, which results in phi-valuation for the former and absolutive case for the latter. If true, this implies that long-distance agreement in Tsez is only apparent and is instead accomplished only between sisters. The derivation finally culminates into TP-1.

The reprojected structure must be preserved for LF to interpret it, which implies that XP cannot be modified or changed till it is shipped out to the interfaces. More specifically, the internal structure of XP – constituting the reprojected DP and TP-1 - is technically immune to the maneuverings of the narrow syntactic system. This has some immediate

implications for LDA configurations, the first of which is to block the absolutive DP from targeting positions outside XP. We now have an explanation for why LDA is restricted to the immediately higher verbal head. The absolutive is stranded inside XP and it cannot move to the domains of other verbal heads, triggering phi-agreement with them. The lack of successive-cyclic LDA thus falls out naturally under my account. Object stranding within XP also influences the scope patterns in LDA sentences. Since the absolutive DP is a complement to the verbal (v) head, it fails to c-command the matrix subject, which base-generates as the external argument of v-1.²⁹ Absolutive topics thereby end up with obligatory narrow scope.

3.5.1 Intervention Effects or A over A violation?

With the alternative analysis in place, let us see if we can answer for why LDA is blocked when the following elements are present in the embedded clause: a) overt complementizers, b) wh- and focused phrases, c) adverbial topics and d) non-absolutive topics. The first three intervening elements, along with adjuncts, I have claimed points towards an embedded CP that impedes long-distance verbal agreement. As to why a CP must act as a barrier to agreement, I had left the issue suspended. I might have an answer now.

Recall that Tsez allows clausal complements to optionally trigger verbal agreement. In other words, CPs are themselves carriers of phi-features. With this assumption, consider what a full blown CP structure, containing an absolutive DP would look like (90):

²⁹ I come back to the issue of successive-cyclic LDA in the next section, where I provide a second reason for why some languages do not allow that option.

(90) [CP = DP [TP [_vP DP [VP]]]]

+Agr

+Agr

Existing literature already notices a similarity between CPs and DPs (cf. Kayne 1983). Particularly in Tsez, there is actual evidence suggesting an underlying thread tying the two. I suggest that this similarity is at the root of the blocking effects observed with Tsez CPs. It is their DP status that prevents lower DPs to move across them on the grounds that the movement violates the A-over-A-condition. Not surprisingly then, whenever a CP is present, absolutive DPs fail to move to the theta-domain of the adjoining clause, whose predicate ultimately selects CP as its complement and triggers agreement with it.

The next issue to address concerns the strategy used to topicalize other embedded arguments. This will ultimately allow us to explain the blocking effects caused by non-absolutive topics in the embedded clause. I suggest that it is not simply absolutive DPs that are topicalized via the alternative mechanism, but non-absolutive topics undergo the same process. They too must trek through the theta-domain of the adjoining clause before they are reprojected and predicated to the embedded TP. The empirical repercussion is the absence of multiple argument topics in the language. Multiple topics vie for the same structural position and eliminate each other in the process. We witness the effects of the competition in LDA configurations too. Absolutive arguments cannot trigger cross-clausal agreement when there is a second (and probably higher) non-absolutive topic in the structure. Under this approach, LDA by the absolutive is ruled out because a different

topic is chosen as the complement of the matrix verbal head. The absolutive remains stranded in the lower clause and consequently fails to control main-clause verbal agreement.

There is an easy empirical argument against the analysis I have provided above for embedded non-absolutive topics. After all, it was categorically mentioned that only absolutive topics trigger cross-clausal agreement. If ergative or dative case-marked embedded topics are licensed by the same mechanism that I propose licenses absolutive topics, then it is natural to expect a slightly larger list of agreement triggers in the language. Why, for instance, can't Tsez have structures corresponding to the following sentence?

(91) The mother knows-I [boy-erg.I bread.abs.III eat.III]

Notice that it is not enough to say that since absolutive DPs trigger agreement, we cannot expect to see main clause verbal agreement triggered by the embedded ergative subject in (91). Under my account, the embedded ergative subject moves out of the lower clause to the complement position of the higher predicate where it receives a second theta-role and by virtue of that, an extra structural case. This case is eventually valued absolutive against v. Absolutive subject turned object can then trigger class I agreement on the matrix verb.

I believe that there is a way out of the problem. But for that, the topicalization strategy must be fore-grounded and understood in the context of topicalized structures from other languages. Take for instance, the Norwegian case. As has been noted in previous studies, (cf. Taraldsen 1981; Bejar and Massam 1999), embedded (nominative) subject topics – en route to the left-most edge of the main clause - pass through the ECM position of the matrix verb and receive an extra accusative case. However, the language also imposes a morphological restriction on the topic by permitting only DPs with the same case-morphology to move. Proper names and second person plural pronominal subjects are the only elements that are underspecified for nominative and accusative case. As a result, (92)-(93) are the only legitimate sentences with dislocated embedded topics in Norwegian. Others like (94) are ruled out for violating case-syncretism.

(92) Per-i hadde de trod [t-i [t-i ville komme forsent]]

Peter had they thought would arrive too late

‘Peter, they had thought would come too late’

(93) dere-i hadde de trod [t-i [t-i ville komme forsent]]

You-nom/acc-pl had they thought would arrive too late

‘You, they had thought would come too late’

(94) *jeg/meg/du/deg/vi/osss hadde de trod [t-i [t-i ville komme forsent]]

I/me/you-nom-sg/you-acc-sg/we/*us had they thought will come too late

I/you/we, they thought will come too late.

Notice that there is no obvious syntactic explanation for excluding sentences with first, second (sg/dual) or third pronominal topics. They perhaps undergo long-distance topicalization, as well. That is to say, since they do not transgress any known syntactic rule and by that logic, sentences like (94) are perfectly derivable. The reason why they are unacceptable is because they fail to abide by the morphological idiosyncrasy of the language. I believe that Tsez embedded argument topicalization has a similar case-syncretism requirement. Embedded topics must bear the same case morphology in the upstairs and downstairs clause. Absolutive DPs are the only ones that fit this description, and it is not surprising that we find only constructions with cross-clausal agreement triggered by absolutive topics. On the other end, LDA constructions with non-absolutive subjects and indirect objects are not syntactic anomalies, but their topics fail the case-syncretism requirement. This leads to the unacceptability of structures like (93).³⁰

3.6 Chukchee and Innu-aimûn LDA: A Problem?

Let us recapitulate the main points of the alternative analysis here. Tsez has a different topicalization strategy for its embedded argument. This involves moving the argument through the theta-domain of the matrix predicate, ending up with a second theta-role and an additional structural case value. It is impossible to implement the strategy in the presence of an embedded CP, which has DP-like features and can trigger agreement against the verb that selects it as a complement. Moving a DP contained within the CP violates the A-over-A condition.

³⁰ As also discussed for sentences with LDA across infinitivals in chapter 2, PF has the discretion to pronounce one of the copies of the moved element.

The first empirical challenge for the alternative analysis therefore comes from languages where LDA is attested across CP-boundaries. Take for instance, the Chuchkee and the Innu-aimûn sentences in (95) and (96) respectively.^{31,32,33}

(95) ənan qəlyiļu ləŋərkə-nin-et [iŋqun Ø-rətəmpəv-nen-at qora-t].
 he-inst. regrets-3-pl. Comp 3sg-lost-3-pl reindeer-pl.nom.
 ‘He regrets that he lost reindeers’

(96) N-u î-tshissenim-âu tshetsh î mupihtâshkuenit kassinu kâuâpikueshit
 1-want-know-3 if visited-2/inv. every priest
 ‘I want to know of them if every priest visited you’

These languages – unlike Tsez - allow agreement with embedded arguments across intervening CP-boundaries hosting overt complementizers, as illustrated by the above examples. In (95), the matrix verb shows third person plural agreement with the object *reindeers* of the embedded CP-complement, while in (96), it is the embedded subject

³¹ The Chuckchee example is taken from Stjepanovic and Takahashi (2001), also cited in Boskovic (2005) and the Innu-aimûn cases are from Branigan and MacKenzie (1999).

³² I concentrate on Innu- aimûn LDA here. Whatever conclusions I draw for it should naturally extend to Chukchee.

³³ Innu-aimûn (an Algonquian language) is a morphologically rich, pro-drop language with relatively free word order. Transitive verbs are divided into transitive animate (TA) verbs and transitive inanimate (TI) verbs, on the basis of their inflections and stem forms. TA verbs appear in the direct or indirect voice, depending on the person and obviation features of the subject and direct object. Some examples are given below in (i) and (ii) to show the difference in agreement morphology triggered by inanimate and animate objects.

(i) Tsh-uâpât-en
 2-see-TI (inanimate object)
 ‘You see it’
 (ii) Tsh-uâpam-in.
 2-see-I
 ‘You see me’

every priest that controls agreement. Even more importantly, Innu-aimûn CPs can also (optionally) control verbal agreement. This is illustrated with the help of the Innu-aimûn sentence below. The main clause optionally agrees with the clausal complement (97), which gets morphologically manifested as Transitive Inanimate (TI) agreement. Compare it with the sentence in (98) where verbal person and number agreement is controlled by the embedded subject.³⁴

(97) Ni-tshissenitamû- ânân mupishtuât Shushepa Tshân mâk Mânî

1pl-know-TI-1pl visit Joseph John and Marie

‘We know that John and Marie visited Joseph’

(98) Ni-tshissenim- ânân-at mupishtuât Shushepa Tshân mâk Mânî

1pl-know-1pl-3pl visit Joseph John and Marie

‘We know that John and Marie visited Joseph’

Branigan and Mackenzie also identify a clear semantic difference between the Innu-aimûn examples with cross-clausal agreement versus those with clausal agreement. Only in the former, are arguments (that trigger cross-clausal agreement) interpreted as topics. A third property of LDA constructions is that the agreement triggers sometimes surface at the edge of the embedded clause, as shown in (99).

³⁴ Agreement in Innu-aimûn bi-clausal structures can be triggered either by the subject or the object of the complement clause.

(99) N-u î-tshissenim-âu kassinu kâûâpikueshit tshetsh î mupihtâshkuenit

1-want-know-3 every priest if visited-2/inv.

‘I want to know of them if every priest visited you’

These are then the defining characteristics of Innu-aimûn LDA constructions: (a) agreement can proceed across CPs, (b) CPs also have phi-features and (c) agreement triggers are topics. The property listed in (b) is what concerns us most here. I take it to suggest that Innu-aimûn CPs have DP-like properties and they host phi-features. This is a potential problem for the alternative analysis proposed here. If clauses are DP-like, then Innu-aimûn LDA has the underlying structure in (100).

(100) [CP = DP [TP [vP DP [VP]]]]

+Agr +Agr

Previously, I had ruled out structures like (101) for Tsez LDA on the assumption that moving the lower DP over the one containing it leads to an A-over-A violation. However this is exactly the configuration that allows LDA in Innu-aimûn and Chukchee. Therefore, either the alternative analysis cannot be extended to these languages or else they have some specific property that allows them to disregard the A-over-A constraint and move their DPs over the dominating CP. In what follows, I claim that the latter is true and that the sideward movement analysis can be extended to these languages with slight technical modifications.

Here are then the relevant steps leading to Innu-aimûn LDA. The LDA trigger (the subject *every priest* in (99)) is moved from the specifier of TP-2 where it gets a case value; this is shown in 101(i). In (ii), C is introduced with a set of phi-features and the structure is extended upto CP-2. In (iii), the embedded subject adjoins to CP-2. Once this happens, CP-2 does not dominate the subject, since there is a segment of CP-2 that fails to dominate it. The nominal can then escape the lower CP without violating the A over A constraint and move to the next clause as the complement to the matrix verb (102).

(101)

(i) [TP subj [T [vP subj v]]]

(ii) [CP [C [TP subj [T [vP subj v]]]]]

(iii) [CP DP-topic [CP [C [TP subj [T [vP subj v]]]]]]

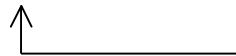

(102) [V DP-topic] [CP DP-topic [CP [TP Subj]]]



DP-movement out of the embedded complement as in (102) is reminiscent of quantifier raising out of DPs in the language. Take for illustration, the LDA sentence (103), where the quantifier *every* moves out of the DP *every priest* containing it.

(103) N-u î-tshissenim-âu kassinu tshetsh î kâuâpikueshit mupihtâshkuenit

1-want-know-3 every if priest visited-2/inv.

‘I want to know of them if every priest visited you’

Since it is only the quantifier that appears left to the embedded complementizer, matrix verbal agreement in (103) must be triggered by it; in other words, the quantifier must carry the phi-values of the entire DP *every priest* in order to assign it to the main-clause verb. I therefore assume that the quantifier phrase/QP starts off adjoined to the NP *priest* wherein it gets the phi-values of the latter. NP is then selected by a D head (following previous works by Corver 1992; Boskovic 2005; also see Abney 1987 and Uriageraka 1988). Consider (104):

(104)

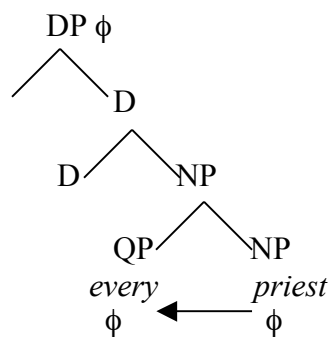

For sentences like (99), the entire DP targets first a CP-2 adjoined position and then the complement position of the matrix verb. The problem arises when we want to explain how the quantifier (*every*) escapes out of the DP in (103)/(104). Since the DP bears the same set of phi-features that QP carries and is closer to the next highest head in the tree, QP movement over DP must violate the A over A constraint. The fact that Innu-aimûn allows this movement indicates that it has the ability to obviate this constraint. I claim that it does this by adjoining QP to DP; QP adjunction once again disallows the DP to

dominate it. Therefore, when QP moves out of DP-2, there is no A over A constraint. Schematically (105).

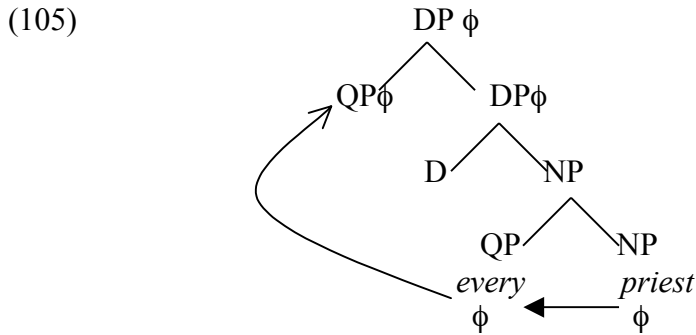

The QP next targets a CP-adjoined position, and once again, CP-adjunction allows it to obviate a possible A over A constraint. It continues its journey to the next tree, once the matrix verb is introduced into the derivational workspace. What the above discussion shows is that adjunction to a phrase that could possibly cause intervention for a lower item, is an option that Innu-aimûn allows generally. That this option should be used in the generation of LDA sentences is therefore not very surprising.

The implications of my analysis for Innu-aimûn are stated as follows. To start, if I am right, Innu-aimûn is different from Tsez in that it licenses its argument topics within the embedded CP and its topics asymmetrically c-command their modifying expressions. That is, the required predication relation that I suggested exists between a topic and its modifying clause is satisfied at the level of the lower clause; the adjoined nominal can c-command TP-2 from its CP-adjoined position. This means that the CP need not immediately be adjoined to matrix VP to establish a predication relation with the topic.

There is, furthermore, no need for DP-reprojection in Innu-aimûn. This mutual independence in turn has two implications for the language, the first of which is that the DP can move to the specifier of matrix vP for case and phi-feature checking. See (106).

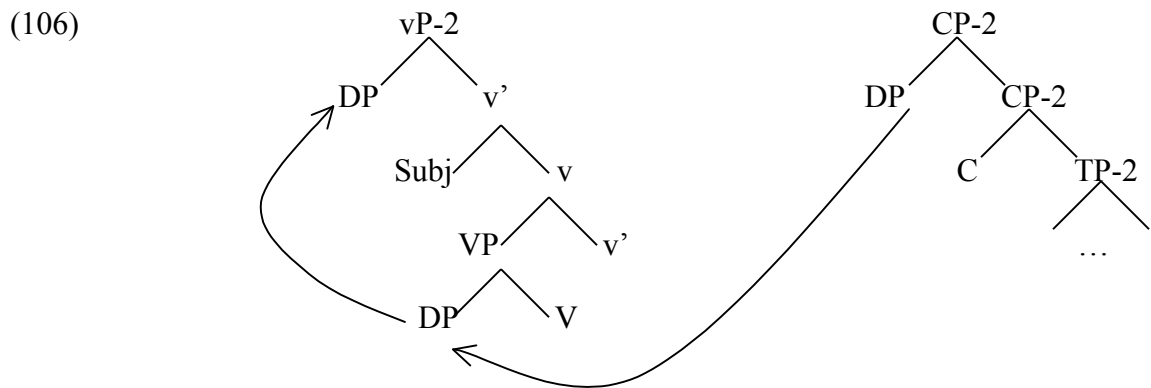

Since it is not stranded inside any structure that must be preserved for LF purposes, the DP is free to seek the next highest feature-checking head to satisfy its newly acquired structural case. Tsez is not allowed this option, as the process of reprojection – motivated for predication between the raised nominal and the embedded clause – was sufficient to bring the DP to a local relation with the matrix v. Moreover, once the reprojected structure was obtained, the topic was stranded inside it and could make no further moves.

DP-movement in (106) is an instance of A-movement, resulting in phi-valuation for v and case-valuation for the DP itself. Once it is case-valued, the DP can undergo only A-bar movement. The nominal is not expected to phi-value higher heads as case-valuation is supposed to render it inactive for phi-computations. Branigan and MacKenzie show that this is indeed the case. Double embedded sentences are bad with matrix agreement

controlled by an embedded argument, as (107) shows. In such situations, matrix verbal agreement must be default (108).³⁵

(107) *Tshi-tshissi^{ti} ta^{ti}-in ka^{ti}-kuetshitshemu-iaⁿ taⁿ ishpish tshi-papi^{ti}.

2-remember-1/INV PRT-asked-1/INTR when 2-laughed

‘I remember that I asked when you laughed.’

(108) Ni-tshissi^{ti}-en ka^{ti}-kuetshitshemu-iaⁿ taⁿ ishpish tshi-pa^{ti}

1-remember-TI PRT-asked-1/INTR when 2-laughed

‘I remember that I asked when you laughed.’

Secondly, assuming that it is not spelled-out unless it merges with the adjoining tree, the lower CP should remain visible for A-bar extraction.³⁶ We therefore expect to see long-distance A-bar extraction in cases where LDA obtains. The prediction is borne out in (111)-(112).

³⁵ Unfortunately, Branigan and MacKenzie do not provide an example where the second verb agrees with the embedded argument. That would provide more convincing evidence suggesting that A-movement is disallowed beyond the point where case is valued on the moved DP. There is also no indication if topicalization is also barred across multiple boundaries. If for instance, the embedded topic is the primary topic of the entire sentence in (107), we predict it to undergo sideward movement to the complement position of the higher verb and trigger verbal agreement with it. It is unclear from Branigan and Mackenzie’s paper if the embedded subject is the topic of the most deeply embedded clause or acts as the primary topic of the sentence.

³⁶ This implies that sideward movement can target non-theta/non-case positions too (see Taylor 2006 for more evidence).

(111) Auen tshit-itenim-a^u aimi-epan Ma nōua?

who 2-think-3 called-3 Marie

‘Who do you think called Marie?’

(112) *Auen tshit-itenit-en aimi-epan Ma nō^uua?

who 2-think-_{TI} called-3 Marie

‘Who do you think called Marie?’

In (111), wh-extraction is possible when the embedded object *Marie* controls verbal agreement in the main clause. In the alternative that I have proposed here, CP-2 does not need to be adjoined to the DP-complement of the matrix verb after the nominal sideward moves from CP-2. Since the topic-predication relation between the moved DP and the embedded TP is already established at a prior point of the derivation, CP-2 may remain unattached. This allows wh-phrases inside CP-2 to target appropriate heads in the adjoining tree. This is shown in (113).

(113)

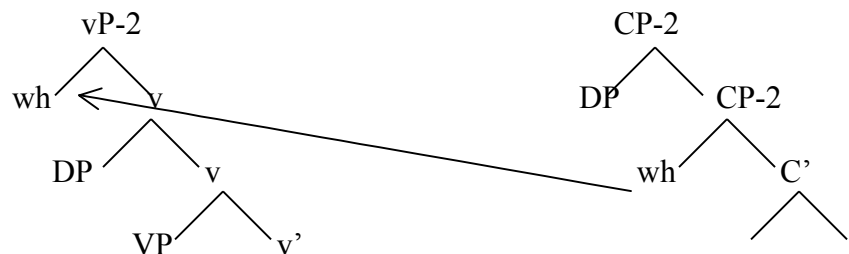

On the other hand, if CP-2 acts as the complement to the matrix verb and targets the specifier of vP-2 to trigger inanimate agreement with it, it is immediately rendered as an

island for future A-bar extractions. Its internal structure therefore cannot be accessed for further narrow syntactic computations. This is what we see in (112).

To end this section, languages like Innu-aimûn and Chukchee where LDA is triggered across embedded CP-clauses do not argue against a theory where the topic sideward moves to the complement of the next highest head. CPs bearing phi-features do not block the movement of a DP that adjoins to it.

I now proceed to a discussion of Passamaquoddy LDA constructions, which are interesting on two accounts. First, this language has clear evidence of overt topicalization. Secondly, evidence presented in the literature so far (cf. Bruening 2001) suggests that this movement is confined to the edge of the lower clause. In the following section, I am mainly interested in reexamining Passamaquoddy data in the context of the alternative movement analysis proposed above.

3.7 Passamaquoddy LDA: Evidence or Counter-evidence?³⁷

As in Innu-aimûn, agreement on a matrix verb in Passamaquoddy can be controlled by either its complement clause, identified as Transitive Inanimate (TI) verbal form (114), or with one of the arguments of its complement clause (115)-(116) that is either the topic or

³⁷ All Passamaquoddy examples, unless otherwise mentioned, are from Bruening (2001).

the focus of the sentence, manifested as Transitive Animate (TA). The agreeing DPs in these two sentences are *her brother* and *snowshoes* respectively.^{38, 39,40}

(114) Kat=te ‘-kocicihtu-w-on tan oc ‘t-oli-kisi-qsokassi-n
 Neg=emph 3-know.TI-neg-n. wh fut 3-thus-able-cross-n
 ‘He does not know how he is to get across’

(115) ‘-Kosiciy-a-l yaq uhsimis-ol eli keka peciya-li-t
 3-know.TA-Dir-obv. Quot 3-younger-sib-obv comp almost come-obv –3-conj.
 ‘She knew that her brother had almost arrived’

(116) Susehp ‘-kosiciy-à akòm eli Muwin kisi-mil-at Wiphun
 S. 3-know.TA-dir.obv.p. snowshoe-obv.p. comp Muwin perf-give-3com. W.
 ‘Susehp knows that Muwin gave Wiphun snowshoes’

The agreement trigger can be optionally placed to the left of the overt complementizer *eli*, as one can see from the above sentences. This indicates that the subject in (115) or direct object in (116) moves (at least) as far as the specifier of CP, where presumably it checks an A-bar (topic/focus) feature.

³⁸ Passamaquoddy is also an Algonquian language with very complex verbal morphology. First person argument agrees in the prefix, while the third person agreement appears as a final suffix. Some representative examples (from Bruening 2006) are given in (i) and (ii).

(i) N-ucen-a-k
 1-kiss-direct-voice-3P
 ‘I kissed them’
 (ii) N-ucem-ku-k
 1-kiss-inverse-voice-3P
 ‘They kissed me’

³⁹ Clausal agreement overlaps with default agreement morphology.

⁴⁰ On focus triggered LDA, see the next section on Hungarian.

So far, nothing in the Passamaquoddy data sets it apart from the Innu-aimûn cases discussed above. It is therefore reasonable to analyze the LDA structures in (115)-(116) as also involving sideward movement of the embedded clause argument to the complement position of the matrix verb. DP-movement proceeds via a CP-adjoined position, which is a potential barrier as it also bears DP-like features.⁴¹

In addition, Bruening (2001) notes that the language has plenty of evidence suggesting that the topic has moved out of its base-generated position. The argument for movement comes especially from island effects, reconstruction patterns and surface order. I cite some of the relevant island related data below. Take the following cases for illustration. LDA across adjuncts (117), wh-islands (118), and complex NPs (119) is impossible. The DPs *Tolitoli and her friend, men* and *Piyel and Susehp* cannot control agreement on higher predicates across the specific islands they are base-generated in.

⁴¹ Bruening (2006) shows various instances where a DP moves out of another (complex) DP containing it. Take (i) for illustration.

(i) Piyeli ali-wiciyew-t-uwok Mali-wol.

Piyel around-go.with- recip-3P.Mary-obv.

‘Piyel and Mary are going around with each other’

In (i), one of the coordinates can be displaced to the sentence initial position, with the other remaining at the sentence final position. Interestingly, the coordinates, which are separated by lexical material behave like a complex DP in terms of binding and agreement. This is shown in (ii):

(ii) Piyel ali-wiciyew-t-uwok Mali-wol

Piyel around-go.with- recip-3p. Mary-obv.

‘Piyel and Mary are going around with each other’

Based on this data (and contrary to Bruening’s proposal), I assume that the displaced nominal base-generates within a complex DP containing it and the other coordinate and, later targets a higher position in the tree. On the assumption that the complex DP also has a set of phi-features, moving the lower DP over it must in principle lead to an A over A violation. However, the fact that these constructions are perfectly acceptable in Passamaquoddy implies that it patterns very much like Innu-aimun in that the constraint can be overridden by adjoining the moving item to the phrase that poses as a potential intervener or barrier. Extending this observation to LDA sentences, I conclude that the moving topic adjoins to CP that has a set of phi-features and in this way, obviates the A over A constraint.

(117) ??N-kosiciy-a-k ‘Tolitoli naka witapih-il-i eli Mihku koti-maceha-t
[mesq t-i peciyta-htihq]

1-know.TA-dir-3p.T. Tolitoli and 3.friend-obv comp. Mihku fut-leave-
3conj not.yet arrive-3p.conj.neg.T

‘I know (about Tolitoli and her friend) that Mihku is going to leave before t
arriving.

(118) *Ma=te n-wewitaham-a-wiy-ik Susehp kisi-qecimul-osk [keq kisi-htu-
htit skitapiy-ik]

neg=emph. 1-remember.TA-dir-neg-3p. S perf.ask-2.conjInv. what perf-make-
3p.conj man-3p.

‘I don’t remember (about them) if Susehp asked you what the men made’

(119) *N-kosiciy-ak kis-ankuweht-uwon [atomupil-ol Piyel naka Susehp mil-osk-opon-
il

1-know.TA-dir-3p perf-sell-2conj car-InanP Piyel and Susehp give-2conjInv-
pret- partInanP

‘I know (about them) that you sold the cars Piyel and Susehp gave you’

Let us first see how a sideward movement account rules out all the bad cases. I begin
with the PP-clause in (117), represented as in (120).

(120) [PP before Tolitoli and her friend arriving]

Observe that the PP in (120) cannot license a topic DP (as it lacks a CP), hence the subject cannot move to its edge. Suppose instead, that just like the Tsez cases, we decide to make a copy of the DP and merge it as complement to the next lexical verb that is introduced into the derivational workspace. This is obviously not possible with the intransitive verb *leave* in (117), which has only one argument slot that is ultimately occupied by its external argument *Mihku*. Furthermore, by the time the matrix verb is introduced, the PP is already adjoined to the lowest clause, which entails that it is already spelt out and its internal structure frozen for computational purposes. LDA out of adjunct clauses is thus ruled out, as shown in (121).⁴²

(121)

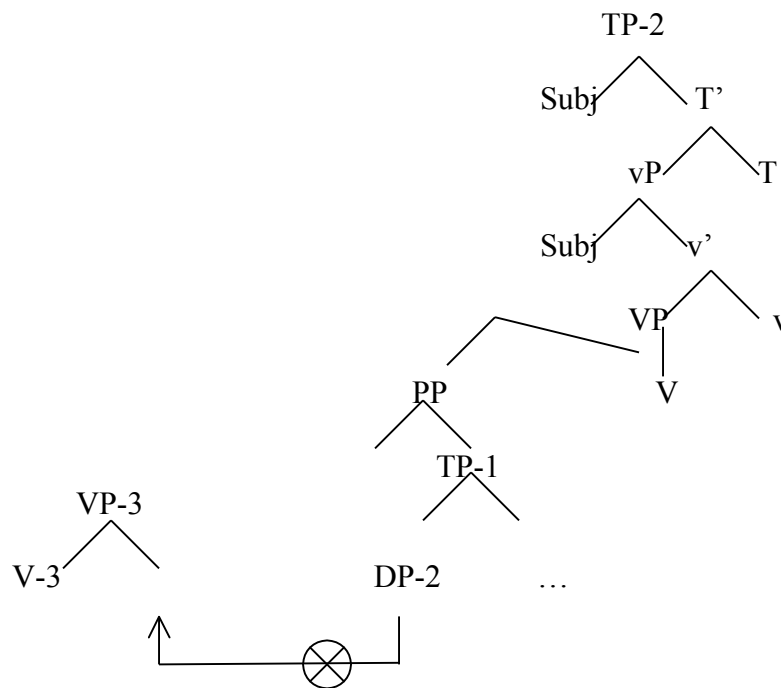

As for (118) which is disqualified for violating a wh-island, the same argument holds. The most deeply embedded clause is already adjoined to another clause by the time

⁴² I disregard the word order here.

matrix V is selected from the numeration. It is therefore impossible to extract further materials out of it. Importantly, a wh-element in the specifier of CP cannot independently block cross-clausal agreement. LDA is perfect with embedded wh-phrases, as shown in (122). Hence, the reason why (118) is bad is not because the topic cannot escape the lowest clause. Rather it is out because it cannot be extracted once the clause that contains it is adjoined to the main clausal skeleton. It is also worth pointing out at this point that (122) shows the agreement trigger *three bears* in a position preceding the CP bearing the wh-phrase *what*. There are two conclusions one may draw from this: either the agreement trigger occupies the outer specifier of CP or it has moved to a position in the main clause. I come back to discuss the evidence presented by Bruening against the latter opinion shortly.

(122) N-kosiciy-a-k nuhuw-ok muwinuw-ok keq kis-temu-htit
 1-know.TA-dir-3p. three-3p bear-3p. what perf-eat-3p.conj
 ‘I know what the three bears ate’

The final case to solve is (119) with illicit LDA across a complex NP. The derivation begins with the lowest clause, culminating in the relative clause *the cars Piyel and Susehp gave you*. However since it is the object of the next verb *sold*, the complex NP is already merged to the clausal skeleton when the matrix predicate is introduced into the workspace. As expected, further movement out of the complex NP is bad (see below for some more cases of LDA across islands).

Bruening however goes on to argue that evidence presented above does not suffice to show that the agreement trigger moves out to a matrix clause position. It can only be considered as proof that the DP controls matrix agreement from the edge of CP. As support for his claim, he cites more examples from the language showing that the agreement trigger is part of the lower clause. The first piece of evidence comes from word order patterns. A VOS order, for instance – which is common in simple clauses - is never attested in Passamaquoddy LDA constructions such as (123), where the embedded object *Tihtiyas* cannot immediately follow the matrix verb *suspect*. Instead the sentence is acceptable only with *Wiphun* (shown in brackets) occupying the position immediately following the verb. This is taken to indicate that the object never moves to a main clause position.

(123) *'-Piluwitanham-a-l (Wiphun) Tihtiyas-ol Wiphun eli kisi-pakatuw-iht
 3-suspect.TA-dir-obv Tihtiyas-obv. Wiphun comp. perf-lie.to3conjInv.
 'Wiphun suspects that Tihtiyas lied to her'

Other problems for cross-clausal DP-movement come sentences like the following, which show that the complement clause cannot be relativized independently of the agreement trigger. This is shown in (125), which is rendered unacceptable for stranding the agreement trigger *Piyel* of (124) out of the relativized embedded clause.

(124) N-kosiciy-a Piyel eli koluski-t.

1-know.TA-dir Piyel comp. lie-3.conj.

‘I know that Piyel lies’

(125) *[Eli koluski-t] nit kesiciy-uk Piyel

comp lie-3.conj. that.Inan IC.know.TA-1.conj. Piyel

‘That (he) lies, that’s what I know about Piyel’

The clause may however be relativized or questioned to the exclusion of the embedded argument when an applicative, valency-changing morpheme (underlined in the examples below) is added to the verb. (126) and (127) are provided for illustration.

(126) [Eli koluski-t] nit eli-ksiciy-uk Piyel

comp. lie-3.conj that.Inan IC.thus-know.TA-1.conj. Piyel

‘That he lies, that’s what I know about Piyel’

(127) Tan-iyuhtol nisonu-l eli-ksiciy-ot Tihtiyas?

Wh-these.Inan two.Inan.p. IC.thus-know.TA-2.conj Tihtiyas

‘What two things do you know about Tihtiyas?’

A third piece of evidence comes from clitic-placement. Second-position clitics (underlined below) appear either after raised DPs (disrupting the constituent) or after overt complementizers. Consider (128) and (129) in this regard. In the former, the clitic *oc* occupies a position immediately following the quantifier *three* (of the agreement

trigger *three snowshoes*), whereas in the latter, the clitic *hc* immediately follows the complementizer.

(128) N-kosiciy-a nuhu oc akom eli Susehp monuwa-t
 1-know.TA-dir-3P three.obv.p fut. snowshoe.obv.p comp Susehp buy-3.conj
 ‘I know that Susehp will buy three snowshoes’

(129) N-kosiciy-a eli=hc Susehp monuwa-t nuhu akom.
 1-know.TA-dir comp.=fut Susehp buy-3.conj three.obv.p. snowshoe.obv.p
 ‘I know that Susehp will buy three snowshoes’

At least *prima facie*, the data so far presented evidences that the agreement trigger fails to target a matrix clause position. But a careful scrutiny suggests otherwise. Take the word order evidence in (123) for instance. It is hard to gauge from the sentence itself about the A/A-bar status of the position preceding the subject. This distinction is relevant for the following reason. There is independent evidence suggesting that an LDA trigger cannot target an A-position preceding the subject, especially if it undergoes movement from its base generated position. If it turns out that (123) hosts a pre-subject A-position, its unacceptability is probably due to the fact that the LDA trigger cannot move to another A-position once its structural case has been valued against the lower v. Let me elaborate.

Passamaquoddy has a morpho-syntactic process of inversion whereby an object that is higher on the person hierarchy than the subject is moved to a position preceding the subject (130). Inverse – on par with A-movement – changes binding relations. In the

following example, the object *everyone* undergoes inversion, which allows it to variable bind the pronominal subject.

(130) Katolu psi=te wen ‘-kosiciy-uku-l wikuwoss-ol.

Of.course all=emph someone 3-know.TA-Inv-obv. 3.mother-obv.

‘Of course, his-i mother knows (about) everyone-i.

The particular property of this phenomenon that is relevant for our purposes is that it is allowed for LDA, but only the agreement trigger base-generates inside an island. Take the following sentence (131) for instance, where the agreement trigger *Tihitiyas or Sapet* occupies the sentence initial position.

(131) Tihitiyas kosona Sapet’ –kosiciy-uku-l wikuwoss-ol eli psi=te

wen macehe [kisi-ntu-htit]

Tihitiyas or Sapet 3-know.TA-Inv-obv. 3.mother-obv comp. all=emph.

Someone leave.3 perf-sing-3pconj.

‘Her mother knows (about Tihitiyas or Sapet) that everyone left after they started singing’

But as I have already alluded to, the cases of LDA under consideration here cannot be obtained across islands. Therefore, as concluded by Bruening himself, LDA structures like (131) must be derived by a separate resumptive strategy, whereby the matrix agreement trigger is co-indexed with a resumptive pronoun in the lower clause. Only

under such circumstances, is inversion or further A-movement allowed. All other instances of LDA are derived by movement, and their agreement triggers fail to undergo further A-movement. The point of the above discussion is that (123) may be bad because its LDA trigger illicitly occupies an A-position. Once these triggers move to the specifier of matrix vP, we expect them to become invisible for phi-computations upon receiving a case-value from the verbal head. The resistance to undergo further A-movement is therefore consistent with my analysis. Furthermore, even though it cannot undergo further A-movement, A-bar movement should not be barred for the LDA trigger. This prediction is also borne out; Passamaquoddy allows its agreement triggers to move to an A-bar position in the main clause, as we see in (132) where the DP *eagle or hawk* moves to the sentence initial position. More importantly, the nominal can reconstruct back and take scope below negation in the embedded clause. This is a pointer towards the movement strategy underlying the construction of the LDA structure in (132).

(132) [Cihpolakon kosona kuhas] n-wewitaham-a eli skat kisi-maton-ihq
 eagle or hawk 1-remember.TA-dir comp. neg. perf-fight-
 1conjInv.neg.

‘I remember that an eagle or a hawk didn’t attack me’ (neither did).

That brings us the second objection raised by Bruening against a matrix clause position for the agreement trigger. He provides evidence that the lower clause cannot be questioned or relativized to the exclusion of the agreement trigger. This point also fails to challenge a movement alternative, as the lower CP that contains a copy of the ‘raised’ DP

is an independent constituent and can participate in other narrow syntactic operations. What might however be problematic for the alternative analysis is if the DP – which I assume has overtly targeted a matrix clause position – cannot be questioned or relativized. Since Bruening does not give a concrete example attesting this fact, I cannot make any deep observations regarding it here. However, as I have just shown in (132), the raised nominal can be independently targeted for A-bar movement, so it is evidently not true that the DP cannot move beyond the embedded clause boundary.

Clitic-placement is also not too serious a problem. Since DPs do move over to the edge of the embedded clause before targeting the matrix verb, clitic-placement may take into account the copy in the specifier of CP. Undoubtedly, there are questions that I will have to leave pending here. As for instance, for my analysis to work, I have to stipulate that clitic placement take places before copy deletion. That said, the validity of clitic placement as a diagnostic in Passamaquoddy is not incontrovertible. As Bruening himself acknowledges, the data on clitic placement is murky. Though generally speakers are consistent with the second position of the clitic in their speech, they also judge sentences with clitics in their non-canonical positions as acceptable. The reason for this discrepancy is not known at present, but what one can glean from it is that Passamaquoddy is (somewhat) flexible on where it places clitics. If true, then clitics do not provide any real insight about the structural position of the agreement trigger.

3.8 Hungarian Focus-driven LDA: Twin Mechanisms

Till this point, I have considered languages where long distance agreement piggy-backs on topicalization. Embedded topicalization in these languages elicit an obligatory underlying representation, which forces topics of lower clauses to move to theta and case positions in the main clause. I now turn to Hungarian that is interesting for two reasons. First, Hungarian LDA is triggered by focused items and wh-phrases. Second, among the set of languages I have considered so far, Hungarian is unique in that it also entertains a second mechanism for long-distance topicalization and wh-movement that exists independently of agreement. To start, consider the following example borrowed from Den Dikken (2005):⁴³⁴⁴

- (133) EGY NÖ-T-i akar-ok, hogy t-i elnök legyen
 a woman-acc. want-1sg.indef. that president be-subj.3sg.
 ‘I want that a woman become the president’

Hungarian presents by far the clearest evidence that LDA correlates with main clause case-valuation for the agreement trigger. The focused DP *a woman* that moves to the clause initial position in (133) receives an accusative case from the matrix verb, while valuing v’s phi-set with indefinite morphology⁴⁵. To put it more concretely, the focused

⁴³ Hungarian has a separate resumptive strategy for focalization that I do not discuss here.

⁴⁴ All Hungarian examples, unless specially noted, are from Den Dikken (2005).

⁴⁵ Hungarian object-verb agreement is manifested in definite/indefinite morphology.

(i) (en) szeret-ek {∅/ valaki-t /egy görög nő -t}
 I love-1sg.indef. someone-acc/a Greek woman-acc.
 ‘I love someone/a Greek woman’

DP switches its case-value from nominative (that it receives as the subject of the embedded clause) to accusative as it rides up the tree. Notice the overt complementizer in this example, which is yet another piece of evidence suggesting that the lower clause is a full-blown structure with non-defective heads capable of checking case on the focused nominal. As with focused elements, *wh*-phrases also optionally trigger LDA along with case-switch. A relevant example is given in (134), where the embedded *wh*-subject carries an accusative case-value taken from matrix *v*. Importantly however, Hungarian disallows *d*-linked *wh*-phrases to trigger cross-clausal agreement. This is illustrated by the sentences in (135)-(136).

(134) KI-T-i akar-sz, hogy t-i elnök legyen
 who-acc. want-2sg.indef. that president be-subj.3sg.
 ‘Who do you want to become the president?’

(135) MILYEN EMBER szerentné-d hogy legyen Béla?
 What.kind.of.man-nom. would-like-2sg.def. that be(come).subjunc.-3sg. Béla
 ‘What kind of man would you like Béla to be(come)’?

(136) *MILYEN EMBER-T szerentné-d hogy legyen Béla?
 What.kind.of.man-acc. would-like-2sg.indef. that be(come).subjunc.-3sg. Béla
 ‘What kind of man would you like Béla to be(come)’?

(ii) (en) szeret-ein {az-t/ ő-t /azt görög nő-t/ Mari-t}
 I love-1sg.def. that-acc/she-acc that Greek woman-acc. Mari-acc
 ‘I love that Greek woman/Mari/her’

Object agreement is however not so transparent and some peculiarities with pronominal objects are stated below in (iii)-(v):

(iii) definite DP objects trigger definite inflection on the finite verb;

(iv) first/second person objects trigger indefinite inflection on the finite verb;

(v) second person objects trigger the special *-lak/-lek* form if the subject is first person singular.

As the above sentences in (135) and (136) show, d-linked wh-phrases can move out to a main clause position, but they cannot change their case values in the process. Den Dikken (2005) calls it the ‘referentiality restriction’, whereby only [+referential] can undergo LDA. Topics and d-linked phrases being [-referential] in Hungarian are disallowed this option. In light of this, I suggest that Hungarian LDA is also derived by moving an embedded argument to a matrix clause position via the complement of matrix V and the specifier of matrix vP, where the actual phi-checking and case-valuation takes place. The only difference between Hungarian and topic-driven LDA in Tsez, Innu-aimûn, Chukchee and Passamaquoddy is that in the former, only [+referential] elements can become the complement of the verb of the adjoining clause. Exactly why this Hungarian-specific restriction takes place is unclear at the moment. I leave it for future research.⁴⁶

As already mentioned, long-distance focus fronting and wh-extraction can also be carried out to the exclusion of LDA and case-switch, as we see in (137) and (138) respectively.

⁴⁶ There is some evidence that Hungarian also has the ability to obviate A over A violations. Hungarian possessive DPs and their agreement patterns have been the focal point of several studies including Szabolcsi (1983), Den Dikken (1999) and Gervain (2003, 2005). It has been observed with regard to phrases like (i) that possessors can stay stranded inside the big DP containing itself and its possessum, without triggering number agreement. However the possessor is also given the option of moving out, in which case it must necessarily impart its number features on its possessum (ii)-(iii).

- (i) a nõk könyv-e-i(*-k)
the woman-pl. book-poss.pl.poss’um-pl.poss’or
‘The women’s books’
- (ii) a nõ-k-nek csak a könyv-e-i%(-k) veszettel
the woman-pl.dat. only the book-poss.pl.poss’um-pl.possi’or got lost
‘Only the women’s books got lost’
- (iii) csak a nõ-k-nek veszettel a könyv-e-i%(-k)
only the woman-pl.dat. got lost the book-poss.pl.poss’um-pl.possi’or
‘Only the women’s books got lost’

On the assumption that the big DP containing the possessor has the same phi-features, this must in principle be an A over A violation. I contend that Hungarian obviates the constraint by adjoining the moved element to the potential intervener. The same claim can be extended to Hungarian LDA which the focused item or wh-phrase adjoining to embedded CP.

In both instances, the fronted phrase retains the nominative case-value that it receives from embedded T and the matrix verb apparently shows the definite morphology of its complement clause.

- (137) %EGY NÖ-i akar-om, hogy t-i elnök legyen
a woman-nom. want-1sg.def. that president be-subj.3sg.
'I want that a woman become the president'

- (138) %KI-i akar-od, hogy t-i elnök legyen
who-nom. want-2sg.def. that president be-subj.3sg.
'Who do you want to become the president?'

If definite morphology on the matrix verb in (134) is triggered directly by the complement clause, it implies that the lower CP in Hungarian also carries phi-features, just like its counterparts in the languages I have considered so far in this chapter. This together with the fact that the language allows cross-clausal focus and wh-fronting without LDA and case-switch raises a potential problem for my analysis. If the CP (optionally) enters into phi-agreement with matrix v, we expect it to pattern like phi-checking clauses in Tsez and Innu-aimûn, and disallow A-bar extraction. Once the clause pied-pipes to the specifier of vP, it must, in principle, become an island for further extraction out of it. Apparently, this is not the case, as illustrated in the above examples. I will argue below that complement clauses are not the actual agreement triggers in Hungarian; instead they are generated as separate clauses in a different derivational

workspace and adjoin to the matrix clause at some later point in the derivation. This allows Hungarian to A-bar extract elements from within the complement clause.

Consider in this regard the following sentence in (139). The matrix verb carries definite agreement, which cannot be triggered by the embedded focused, indefinite phrase. *Prima facie*, the agreement controller must be the complement clause.

- (139) (azt) akar-om, hogy EGY NŐ legyen elnök
 it/that-acc. want-1sg.def. that a woman be-subj-3sg. president
 ‘I want that a woman become a president’

The interesting thing about this sentence is that it hosts an (optionally) overt pronoun *azt* marked with accusative case. If accusative case is assigned to objects, then the conclusion one can draw from structures like these is that it is *azt* or its null counterpart *it/that* which is always chosen as the complement of the matrix verb, and not the clause itself. I depict this in 140 (i).

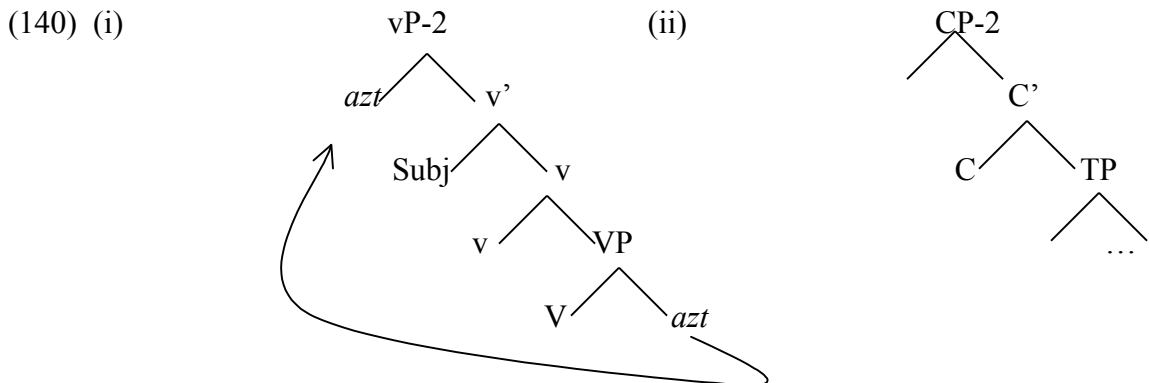

The pronoun is therefore the one to receive structural case from *v* and trigger definite agreement on it (see Kenesei 1994). CP-2 is co-indexed with the pronoun, but it is not merged in the complement position of the matrix verb. Rather, I propose that it is constructed separately as in 140 (ii). These two clauses merge at a later point of the derivation (141).

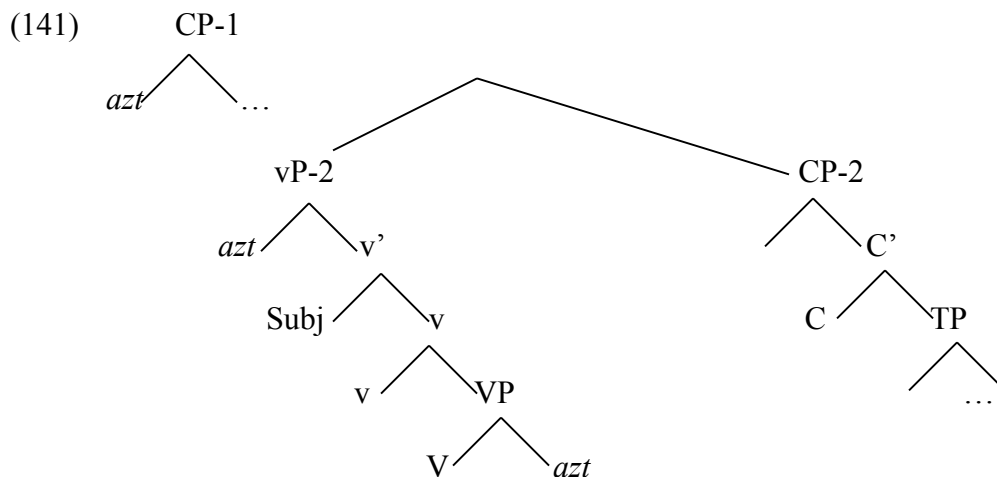

Notice that CP-2 in 140(ii) is open to A-bar extraction as long as the clause itself has not already merged with the main clause and undergone spell-out. A focused or a wh-phrase can sideward move from within CP-2 and target the specifier of some phrase in the main clause before moving to the final target, the specifier of CP-1. (137) and (138) are products of such derivations.

3.9 Basque LDA: A local solution

Basque LDA, that I now turn to, has properties that set it apart from all other LDA instances we have discussed so far in this chapter. To begin, LDA is permitted with direct

objects of obligatory control complements (142). The matrix auxiliary agrees in number with the object of its embedded clause, which in turn is case-valued absolutive. Number LDA is however optional, as we witness in (143). Agreement is also blocked by intervening subjects (144), indirect objects (145) and finite CPs (146).

(142) [nobela erromantikoak irakurtzea] gustatzen zaizko

novel romantic-pl.A read-N-det.A like-hab aux-3pl.A-3singD

‘He/she likes to read romantic novels’

(143) [nobela erromantikoak irakurtzea] gustatzen zaio

novel romantic-pl.A read-N-det.A like-hab aux-3singA-3singD

‘He/she likes to read romantic novels’

(144) *Jonek [traste zaharrak botatzea] erabaki ditu.

John-E think old-det-pl. throw off N-dat. decided aux-3sE-3plA

‘John decided to throw off old things’

(145) *Jonek [Mireni liburu batzuk erostea] erabaki ditu

John-E Miren-dat book some-abs-pl. buy-nmlz-D decided aux-3sE-3pA

‘John decided to buy Miren some books’

(146) *Jonek pentsatu ditu [bizilagunak kontra dituela]

Jon-E thought aux-3sE-3pA neighbor-det-p-A against has-comp.

‘John thinks that he has the neighbors against him’

I assume with San Martin (2002, 2004) and Etxepare (2005) that OC-complements clauses are TPs. In addition, since they get case-valued and control verbal agreement,

they must bear a set of phi-features, which they check against the matrix verb by virtue of being the closest goal to it. This mandates the generation of structures like (142). But the puzzling issue is the optional number agreement triggered by the embedded clause object, which is presumably case-checked against embedded *v*, and yet remains active for number agreement, in defiance of the Activation Condition. Even more interesting is the correlation one finds between number agreement and clausal case. The former can obtain only in those situations where the clause can be case-marked. In all other situations, some of which are listed below, number agreement is impossible. Both clausal case and LDA is impossible when the matrix verb is an unergative (147), a complex predicate (148) or an object control predicate (149).

(147) Jonek [PRO apunteak kopiaetzen] jardun du/*ditu

Jon-erg notes-abs. take-nom-loc worked aux-3sE-3sA/*3sE-3pl.A

‘Jon worked taking notes’

(148) [PRO harri horiek altxatzen] proba egin dute/*dituzte

stone house lift-nom-loc attempt done aux-3pE-3sA/*3pE-3pA.

‘They attempted to lift those stones’

(149) Zuk ni [PRO lan horiek egitera] animatu nauzu/*gaituzu/*nauzkitzu

you me work those-abs. do-nom-all encouraged aux-2sE-1sA/*2sE-1pA.

‘You encouraged me to do those works’

In addition, object triggers are not given any specific semantic (definite/specific, focus or topic) interpretation. This is yet another ground where Basque LDA differs from the other

languages, where LDA correlates with either a topic or focus reading for the agreement trigger. Given these differences, I contend that Basque employs a different strategy to derive LDA. Some possible analyses are discussed below.

Etxepare (2005) suggests one approach that takes as its point of departure Bhatt's (2005) AGREE that allows phi-computations to involve case-marked nominals. This allows him to conceive agreement between matrix heads and embedded case-marked objects. The core aspects of his proposal are as follows.⁴⁷ OC complements have an inner aspectual/temporal head (Asp-1 in (150)) that has interpretable T features and uninterpretable person and number features (in the sense of Pesetsky and Torrego 2001). It probes the DP-object (bearing a non-interpretable tense feature) and assigns it an absolutive case-value. There is a second dependent tense (T-0) in the structure possessing an uninterpretable T feature (Case) and an uninterpretable number feature. Dependent tense checks its features in two different steps. First, it values its number feature against Asp-1. Next, D raises to T giving the latter its person feature. The complex T+D from this point on counts as a complete goal for the aspect head in the matrix clause (Asp-2). In Etxepare's understanding, agreement proceeds in a strict bottom-up fashion, with lower heads getting checked first and then serving as potential goals for higher heads. This way, features of an embedded nominal 'percolate' up to clause-external heads.

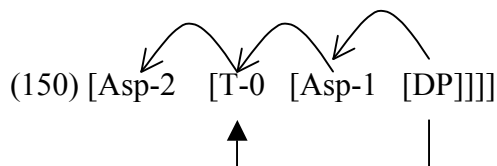

⁴⁷ I disregard some of the intermediate heads that Etxepare proposes as part of the clause-structure for OC complements.

A different approach – also proposed by Etxepare – is that cross-clausal agreement takes place indirectly, with the matrix head first agreeing with the clause in third person and then proceeding to check its number feature with the embedded absolutive DP. For this approach, it is essential that agreement proceeds top-down, beginning with the introduction of the matrix head.

Etxepare's account possesses certain distinct limitations. As for instance, it incorrectly predicts that embedded non-objects – as long as they are complete goals – can also participate in cross-clausal agreement. Under his proposal, it is possible to transfer the phi-value of the embedded subject to the highest head in the embedded clause, and from there, to matrix T head. The facts however suggest otherwise; number agreement is possible only with absolutive direct objects. He also fails to explain how agreement is barred by finite clause boundaries in Basque. To see this, consider the sentence in (145) again. If we were to assume that features percolate up from one head to the other, we incorrectly predict the highest argument (eg. pro-subject or the IO) to indirectly trigger number agreement on the main clause auxiliary (via embedded TP and CP). Notice that the same problems arise when we consider the top-down agreement checking option. Either way, Etxepare leads us to the wrong conclusions.

There is a third approach that is worth pursuing here. It requires us to consider the nature of the agreement morphemes on embedded TPs a little more seriously. There are

especially two morphemes that merit serious attention: (a) *-tze* and (b) *-a*. They are underlined in the following sentence:

- (151) [nobela erromantikoak irakurtze-a] gustatzen zaizko
novel romantic-pl.A read-N-det.A like-hab aux-3pl.A-3singD
'He/she likes to read romantic novels'

The morpheme *tze*, Etxepare shows, has a nominalizing effect. In certain varieties of Basque, for instance, it appears in what Etxepare terms as N(oun)-N(oun) compounds, where it acts to nominalize the verb (see (152)).⁴⁸ The N-N complex is then either marked with a locative postposition or with a genitive marker, as in (153).⁴⁹

- (152) ...ez al dituk gizon-iltzen ariko
neg. prt. aux man-kill-nmlz-Loc prog-fut.
'May they not be killing people (lit-man-killing)'

- (153) Amaika gizon-itzeren errudunak
many man-kill-nmlz-gen guilty-pl
'Guilty of many man-killing'

⁴⁸ *Tzen* is also the morpheme for habitual or progressive.

⁴⁹ The morpheme *-tze/-te*, Trask (1995a,b) observes, is related to other suffixes encoding 'abundance', 'duration', or 'activity'. These were originally restricted to nouns, and were only later incorporated as verbal suffixes.

The locative postposition is also found in other contexts with lexicalized verbs, as when *egin* (dummy do) lexicalizes *v*. It may appear simultaneously on the noun and *egin*, as illustrated in (154).

- (154) Jon futbolean egiten saiatu da
 Jon-abs. soccer-D-loc. do-nmlz-loc. tried aux.
 ‘Jon tried to play soccer’

Assuming that Basque locative is a non-structural case, I contend that it is assigned to DPs in situations where a structural case-checker is absent. It predictably appears on nominals either stranded within infinitivals or when they are selected by lexicalized verbs (152)-(154). The genitive marker on the other hand, Etxepare concludes is assigned by a nominalizing head merged lower than T. Once again, on the assumption that +N heads cannot check structural case, it is reasonable to suggest that Basque genitive is a non-structural case. Another interesting thing to note about genitive case-marked objects is that they cannot be scrambled (see (155) below), which is emblematic of elements that have undergone some kind of incorporation into its adjoining (verbal) element.⁵⁰

- (155) *[Liburuaren Jonek erostea] ez zait ondo iruditzen
 book-D-gen Jon-erg buy-nmlz-D. neg aux. good look-imp
 ‘I don’t like that Jon buys the book’

⁵⁰ Basque lacks ‘real’ noun incorporation. See Etxepare (2005) for evidence.

From these facts, I conclude that *tze* in number LDA complement clauses nominalizes the verbal head it adjoins to, leading it to forsake its structural case-checking property. This yields structures like (156), with the internal argument either (pseudo) incorporating into the nominalizing head or forming a complex N-N compound receiving a non-structural locative or genitive case in the process.⁵¹

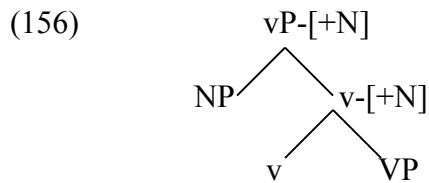

LDA structures like (151) are also characterized by a second bound morpheme *-a*, which I believe, can shed some more light on their underlying representations. The *-a* morpheme is traditionally considered as an article or a determiner, as shown in (157). But it also appears with plurals, where its definite status becomes optional (158). Even with singular DPs, it is sometimes interpreted with an existential import, as illustrated in (159). Unsurprisingly therefore, they are also found in existential constructions (160). Finally, the morpheme can also attach to mass nouns (161) and predicates (162).

(157) *liburu-a*

book the

‘The book’

⁵¹ I depart from Etxepare in assuming that functional *v* assigns absolutive to objects (à la Laka 1993)

(158) liburuak

book-D-pl.

‘books/the books’

(159) Jon_{ek} kotxe berri_a erosi du

Jon-erg. car new-D bought has

‘Jon has bought a new car’

(160) Hemen badira liburuak

here there-are book-D-pl.

‘There are books here’

(161) Ardo_a edan dut

wine-D drink-partc. aux

‘I drank the wine’

(162) Ni nekatu-a guade

I tired-D am

‘I am tired’

To explain its disparate behavior, Artiagoitia (2002, 2004) posits two different functional heads for the morpheme. When it is non-definite, it corresponds to a number head modifying a bare NP; in all other instances, it is a D. Importantly, the existential reading is reserved for objects, as the contrast between the following sentences shows us. While the object in (163) is ambiguous between a definite and a non-definite reading, the subject in (164) must be interpreted as definite.

(163) Liburuak erosi ditu

book-D-pl. bought has

‘He bought (the) books’

(164) Liburak ondo daude

book-D-pl. alright are

‘The books are alright’

Another point worth mentioning here is that the morpheme can be found in TP (defective or otherwise) clauses too. Take for instance, the following set of examples. A temporal adverbial – which indicates the presence of a (dependent or otherwise) tense head – is licensed only in sentences hosting the *a*-morpheme (165). Once we substitute the morpheme with a demonstrative, a temporal adverbial is deemed unacceptable (166). Moreover, the morpheme is also compatible with overt embedded subjects, which further corroborates the fact that it appears in non-defective clauses. This is attested in (167), a non-LDA, non-OC construction.

(165) [Bihar lan egiteak] amorrutzen nau

tomorrow work do-nmlz-D-erg pisses-me-off

‘Working tomorrow pisses me off’

(166) ??[Bihar lan egite horrek] amorrutzen nau

tomorrow work-do-nmlz demonstrative-erg. pisses-me-off.

‘That thing of working tomorrow pisses me off’

(167) Jon-erg ez du [Aitorrek deus erostea] lortu/erabaki/pentsatu
 Jon-erg. neg. aux. Aitor-erg anything buy-nmlz-D. managed/decided/planned
 ‘Jon did not manage/decide/plan for Aitor to buy anything’

To summarize, the two morphemes (*-tze* and *-a*) found in OC-complements of Basque LDA constructions make different contributions. The first has a nominalizing effect on the verb, which leads to its case-absorption. The result is an N-N compound formed out of the nominalized verb and the object in its specifier. With regard to the second morpheme, we have seen that it may appear on nouns as well as on predicates. It is ambiguous between definite and indefinite/existential readings, though the latter is reserved only for objects. This last point, I believe, can lead us to an explanation for how the object DP – without moving – can ‘percolate’ its number feature up to the matrix predicate.

I will assume that the object is base-generated as in (168), with a DP adjoined to it. The head of DP is the morpheme *-a*. The DP receives the phi-value of the NP in this configuration.^{52, 53}



⁵² (168) may be regarded as a clitic-doubling structure, where the clitic is adjoined to the double.

⁵³ I will assume that there is concord relation between the two XPs here.

Next, the NP moves to the specifier of embedded vP which is unable to case-mark it. DP then moves over to T as sketched in (169).

(169)

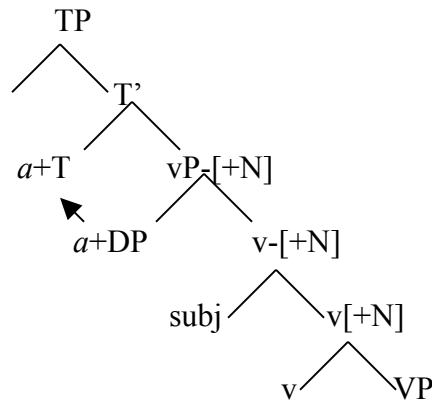

The outcome of the movement in (169) is the same as that induced by the *-en* morpheme in passives (Baker, Johnson and Roberts 1989); *-a* absorbs the structural case-assigning property of T. This has an immediate impact for embedded subjects, which cannot be case-checked within the embedded clause and is thus forced to seek a higher probe. It targets the specifier of matrix vP for theta-reasons and then continues its journey further up to the specifier of matrix TP. The embedded TP on the other hand, has a full set of phi-features, in addition to the numerical value of its object. It serves as a goal to the matrix verb and is case-marked absolutive. The lower object is marked with default absolutive.

This account has the following advantages. We now have an explanation for why number LDA is not possible with finite embedded clauses. Since finite clauses do not have defective verbal heads, objects are case-valued within the verbal domain, rendering the

movement of number-phrase to the tense domain superfluous. The absence of an embedded subject, on the other hand, directly correlates with the inability of T to assign structural case to it, once *a* absorbs its case checking property. Indirect objects or any intervening DPs, especially if they occupy positions higher than vP, act to block number-phrase movement to T.

3.10 Conclusion

This chapter raised some concerns with Agree-based explanations for LDA triggered across finite clauses. I showed some problems with these accounts and suggested an alternative analysis in terms of sideward movement that provides a straightforward explanation for why case-checked nominals can still (sometimes) undergo phi-computations and check additional structural cases. The main thrust of my proposal is that languages under consideration here are allowed some specific topicalization/focus-related mechanism that requires an embedded argument to target the theta-domain of the matrix clause. Assuming structural case to be necessary for theta-role evaluation at LF, I contend that moved nominals must be case-valued again in the main clause. If true, this shows that so-called long-distance agreement is a very local phi/case-checking relation between the DP and a head in the main clause.

Finally, my analysis has important repercussions for the phenomenon of hyper-raising. I initiated the discussion with cases that argue against the standard belief that A-movement out of finite clauses is always illicit. Explaining LDA from the perspective of sideward movement, I believe, is another key to understanding the contexts under which languages

may chose to defy the constraints imposed by finiteness. With respect to the specific languages as hand, this choice is made alongside an A-bar strategy leading to some semantic consequences, such as topicalization, focus etc.

CHAPTER 4

EXAMINING DEFECTIVE INTERVENTION EFFECTS

Chomsky (2000, 2001a, b) imposes locality on phi-agreement by partitioning it into two components: Match where probes seek for goals with the desired feature-composition and Agree where the actual valuation takes place. Defective intervention is implemented at the level of Match where all DPs pose as potential goals, and despite being phi-defective or inactive force probes to terminate their search on encountering the first, closest goal in their c-command domain. It is de facto, the locality principle on agreement in an Agree-based theory where goals and probes can otherwise be placed at an arbitrary distance from each other.¹ It is my aim in this chapter to reveal some problems with the notion of defective intervention and suggest alternative explanations for the data that have hitherto been presented in its defense. The main thrust of my proposal is that the alleged defective intervention effects in reality result from constraints on movement. In line with what I have proposed in the last three chapters, I claim that elements must move to the domain of a head in order to agree with it. However in certain contexts, the presence of a higher DP blocks A-movement for a lower DP. The former holds a possible A-landing site for the latter and moving over it leads to an inevitable minimality violation. Moreover, moving into the minimal domain with the higher DP fails to provide an escape hatch for the lower DP, if the specific movement step does not involve phi-valuation. Under these circumstances, the escape hatch counts as an A-bar position, and any further A-

¹ The other way to impose locality is via phases, an alternative that I do not pursue here.

movement from this site is in violation of the Improper Movement constraint. To the extent that this is true, the absence of agreement cannot be blamed on the blocking effects caused by intervening goals on potential long-distance agreement relations between probes and lower nominals. Rather, it results from the inability of potential goals to A-move to the domains of their targets.

4.1 Defective Intervention: The Basics

Yet another issue to tackle with respect to Agree is the notion of defective intervention. As formulated in Chomsky (2000), an inactive or defective goal β may block the “effects of matching” of a probe α against a lower goal γ iff β c-commands γ and is consequently closer to α . This is schematized in (1), where $>$ signifies c-command.

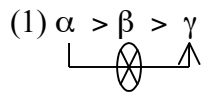

By (1), inactive and defective goals (such as case-marked nominals and expletives respectively) are likely ‘goals’ at the level of Match, a subcomponent of Agree. Match between any given probe P and a goal G in its complement domain observes 2 (i)-(iii).

(2)

(i) Matching is feature identity.

(ii) Domain of (P) is the sister of P.

(iii) Locality reduces to “closest c-command”.

There are at least two important ingredients of Match that merit some discussion here: (a) feature identity is reduced to the choice of features and not of their values and (b) locality (on agreement) is invoked at the level of Match. I elaborate on each of these points below. To start with (a), by the definition of Match (2), an element is a potential ‘goal’ for a probe, simply by virtue of sharing phi-features (irrespective of their values) with it. Notice that it is not necessary that a goal’s phi-set be equal to the phi-set on the probe. If categories are ordered sets of features, each an ordered pair of attributes and values, then feature identity boils down to attribute-identity, yielding possible cases of intervention by items with defective or incomplete sets of phi-features. A prerequisite for Match is therefore, that the probe and the goal share at least one attribute. Elements may be defective and carry fewer attributes than the probe, but they can still count as interveners as long as they fall in the c-command path between the probe and a lower goal. These two possible scenarios of intervention are provided in (3) and (4).^{2,3}

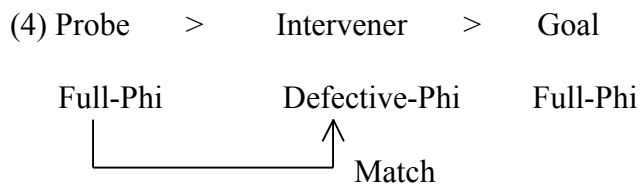
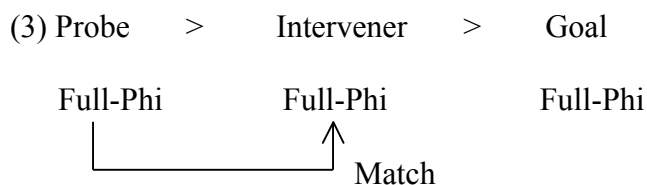

² Thanks to Juan Uriagereka for suggesting this finer distinction.

³ Though ‘attribute’ is possibly the more appropriate term, I will stick to ‘feature’ when referring to defective intervention in the rest of the chapter.

A second relevant point attached to (a) is that structural case plays no role at the level of Match. A case-checked nominal is visible to the computational system for Match even when it is rendered inactive for Agree purposes. This conception of ‘visibility’ comports with the idea that features – when checked/valued – though instantaneously marked for deletion, are not erased until the next phase up. Under this conception, a DP – that is already case-checked – remains a potential goal till a certain derivational point, even though it is incapable of triggering phi-agreement on higher heads. In a nutshell then, a DP is active at the level of Match due to features/attributes (5) while active at the level of Agree owing to its unvalued structural case (6).

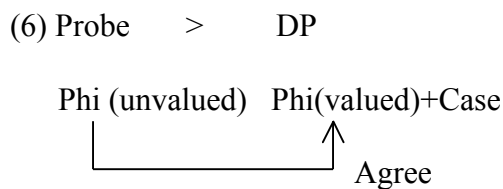
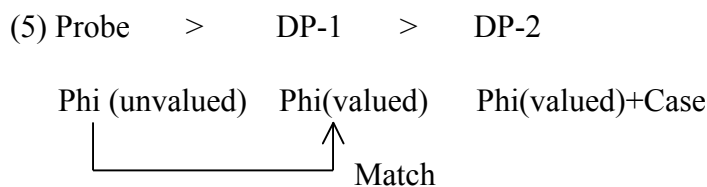

The second crucial point (b) is that locality is determined at the level of Match. By the definition given in (2), a probe fails to extend its search beyond the point where it encounters the highest goal with features. However agreement between them is possible only when the goal is active with an unvalued case. An inactive goal does not value the probe’s features but prohibits it from seeking another goal, as shown in (7).

Subsequently, the probe either takes default value for its non-interpretable features or its unchecked features ultimately lead to derivational non-convergence.

(7) Probe > DP-1 > DP-2

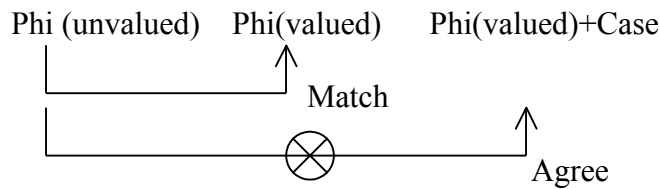

Having elaborated on the relevant aspects of Match and defective intervention, let me now turn to a few examples from the literature (see Chomsky 2000) to witness the mechanisms at work. Take (8) to start with:

(8) *there seem [[several people] are [friends of yours]]

(8) is an unacceptable English expletive-associate construction. The matrix predicate *seem* cannot agree with the embedded object *friends of yours*. Consider its underlying representation in (9) now:

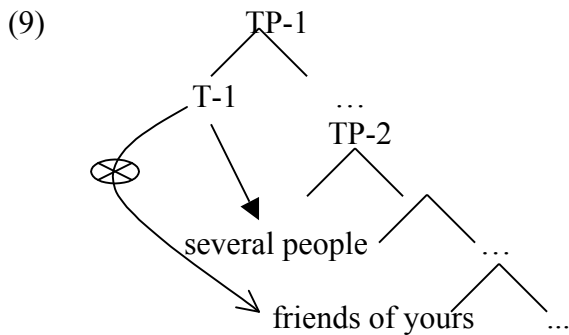

Overlooking the details of how predicate nominals are analyzed in the literature, what we see in (9) is allegedly a case of defective intervention. In Chomsky's opinion, the reason matrix probe (T-1) fails to agree with the embedded argument *several people* is because there is an inactive, but visible (to the computational system) subject that blocks matrix T's search space. When T-1 starts searching for an appropriate goal to check its phi-set, it first encounters the subject *several people*. This DP is already case-marked inside TP-2, which renders it unsuitable for agreement with the higher tense head. Nonetheless, it is a potential goal for T-1 at the level of Match and disallows the probe from looking beyond it to agree with the object *friends of yours*. An expletive *there* is thereby merged in T-1's domain, but the derivation fails to converge as the person feature on the expletive does not suffice for T's full phi-set.⁴ Notice that in this instance, the intervener is an inactive DP with a full set of phi-features. As noted above, defective interveners could also be items that do not bear full sets of phi-features. The example in (10) illustrates one such case of defective intervention.

(10) *There seem there to be three men in the room.

Chomsky argues, with respect to (10), that the intermediate expletive has a person feature that fails to receive a value from infinitival T, the latter having already checked its features against *three men* at a prior derivational point. When matrix T is introduced into the derivation, it seeks a goal to value its complete phi-set. The first element it encounters in its complement domain is the intermediate expletive with a person feature (see (11)),

⁴ I come back to some problems with this analysis later on in the chapter.

which forces it to end its search at this point. However, since T cannot check its full phi-set against the expletive's person feature, it must remain without feature-values, consequently leading to a derivational crash.

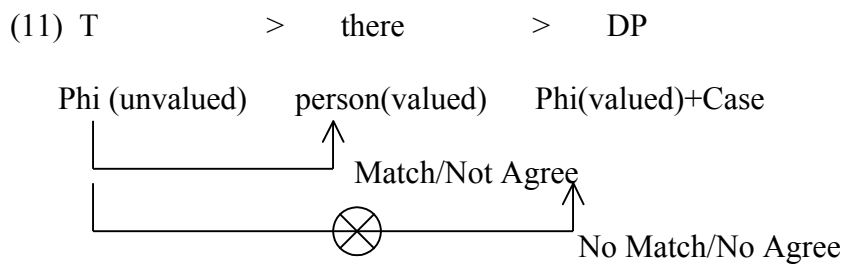

A slightly different perspective on intervention is given in Boeckx and Jeong (2003), which restrict intervention to those cases where the intervening item and the goal it c-commands possess the same features. They base their observations on structures like the following (12).

(12) There look as though there are two men in the room.

(12) is a multiple expletive-associate sentence in English, where the matrix T agrees in number with the embedded argument (*two men*). (13) is its underlying representation:

(13) [TP there T (...) [TP there (...) [DP two men]]]

+Num.	+Person	+Num (+Person)
-------	---------	----------------

Notice that the intermediate expletive in (13) bears a person feature, which, by standard accounts, makes it a potential intervener. It is therefore puzzling that number agreement with T is actually allowed with the lower DP *two men*. The acceptability of these utterances motivates Boeckx and Jeong to propose certain amendments to the notion of defective intervention. Contra Chomsky, they propose that intervention is never defective; rather items must have the same features as the elements that they c-command in order to be counted as interveners. Since the features on the embedded expletive fail to match the type and number of features on the probe and the lower DP in (13), it also fails to block agreement. The person feature on the expletive is insufficient to cause intervention for the probe seeking a goal with a complete set of phi-features. Intervention must always be direct, with the intervener and the goal carrying equal sets of features.⁵

To summarize, there are broadly two ways of conceiving intervention. It may be caused by defective and inactive elements possessing at least one of the features on the probe. On the other hand, intervention must be always direct, with the intervener necessarily displaying (at least) those features as the next potential goal. As I discuss below, both theories of intervention are insufficient at the face of more empirical evidence. What is worse, even the purported evidence supporting these theories do not seem satisfactory enough.

⁵ In terms of attributes, this would mean that the intervener must have (at least) all the attributes of the next goal in the structure.

4.2 Problems with Defective Intervention

In this section, I bring up some other instances of defective intervention effects and show how these too, like those discussed in the previous section, cannot be taken as real support for the notion. I begin with some cases of intervention caused by covert categories.

For some researchers, interveners need not be overt. Covert categories like PRO, pro can also impede probe-goal relations. One such instance was brought up in chapter 2 in the context of Agree-based theories propounded by Boeckx (2004) and Bhatt (2005). They independently suggest that Hindi-Urdu LDA structures like (14) are possible only with restructuring bare VP-complements that do not host PRO-subjects. The underlying representation of (14) is given in (15).⁶

(14) Johnne [roTii khaanii] chaahii.

John-erg. bread-fem. eat-inf.-fem. want-fem.past.

‘John wanted to eat bread’

(15) [v [V [VP V Obj]]]

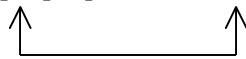

LDA

Non-restructuring predicates, on the other hand, present a different scenario. When these predicates are selected, the complement clause must license a PRO-subject, which then

⁶ If intervention is determined solely by feature identity, the covert/overt status of interveners must in principle, be orthogonal to the issue at hand.

acts to impede cross-clausal agreement with the embedded object (16), resulting in non-LDA structures like (17).

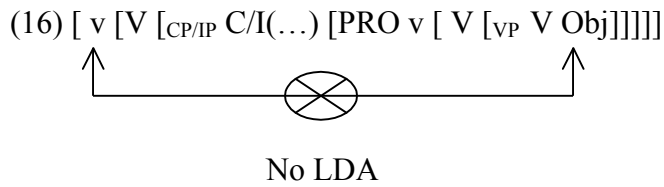

(17) Johnne [roTii khaanaa] chaahaa.

John-erg. bread-fem. eat-inf.-def. want-def.past.

‘John wanted to eat bread’

In chapter 2, I presented some problems with these accounts, in the process substituting them with a movement alternative. I will not repeat the details of the alternative here, and instead focus on the issue of intervention as adopted by these researchers.⁷ My aim here is to see if the notion of intervention – defective or otherwise – is even required to explain the lack of LDA in (16)/(17). Consider then a little more closely Boeckx and Bhatt’s proposed underlying representation in (18), a slightly detailed version of (16). The complement clause in (18) is a TP, with T selecting a vP.⁸, where v is a non-defective head capable of checking structural case on the object. For the sake of discussion, let us assume with Boeckx and Bhatt, that structural case (and phi-features) can be checked long-distance. Under this approach, embedded v can enter into a long-distance relationship with the object placed inside its VP-complement. The object

⁷ The movement alternative undermines the notion of defective intervention by assuming that the embedded object in LDA structures with restructuring predicates may or may not move, depending on the presence of a default case value in the downstairs clause.

⁸ There may be a CP-boundary too, but I overlook it for the present purposes.

presumably remains stranded inside VP for the rest of the derivation; i.e. it does not leave its base-generated position at any point of the derivation.

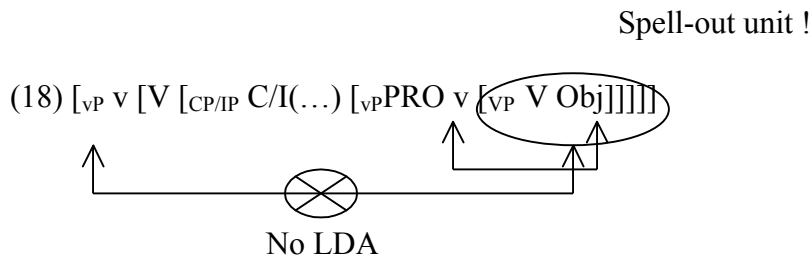

Now notice what happens when matrix *v* is added to the derivation, as also shown in (18). On the assumption that *v*Ps are phases, once matrix *v* is introduced, the VP-complement of the next lowest phase (embedded *v*P) must be spelled out. Given this logic, embedded VP and its internal structure (consisting of the object) are invisible to the computational system by the time the matrix probe starts searching for a goal. This explains why LDA is absent from (16)/(18): matrix *v* cannot look into the spelled out VP and Agree with the object. Observe that LDA could also be ruled out by simply assuming that the embedded object is already case-checked in the downstairs clause, which implies that it is inactive for further phi-related computations (though see Bhatt 2005 for a different approach). Therefore at least for these structures, we need not adhere to the notion of defective intervention by covert categories. Its effects arise for completely different reasons than those postulated by Boeckx and Bhatt.

Furthermore, it turns out that not all overt DPs are potential interveners. I have noted in previous chapters that ergative subjects in some languages do not impede cross-clausal

agreement with objects. Take the following Tsez LDA structure for instance, where long-distance agreement between matrix *v* and embedded absolutive object is obtained across the intervening ergative subject.

- (19) *eni-r* [*uz-a* *magalu* *b-ac-ru-li*] *b-iy-xo*.
 mother-dat. [boy-erg bread.III.abs. III-eat-pstprt.nmlz] III-know.pres.
 ‘The mother knows the bread, the boy ate’

Polinsky and Potsdam (2001) present ample evidence indicating the structurally higher position of ergative subjects vis-à-vis absolutive objects. One such substantial piece of evidence comes from structures like (20), where the ergative subject constitutes the antecedent for the absolutive reflexive.

- (20) *eniy-a* *nela* *ze zek’-si*
 mother-erg. refl.abs. hit-pst-evid.
 ‘The mother hit herself’

From (20), I conclude, on the lines proposed by Polinsky and Potsdam that ergative subjects c-command absolutive objects in Tsez. I assume that in (19) too, the embedded subject lies in the c-command path between the matrix verbal probe and the embedded absolutive object. This makes the subject a very likely candidate for triggering intervention (21).

Intervener?

 (21) matrix v > boy-erg > bread-abs

On the assumption that all DPs – active or otherwise - count as potential goals for Match and also as defective interveners, the puzzle to solve here is why Tsez ergative subjects fail to intercede agreement between v and *bread* in (19). If Match only considers DPs with phi-features, with no consideration to their case-values, we expect ergative DPs to pattern alike with other potential defective interveners. The prediction is however not borne out, as the acceptable (19) shows. Defective intervention therefore seems ineffective in Tsez LDA constructions too.⁹

Coming back to the original sentences used to defend the notion, they too appear inconsequential on closer inspection. Even within an Agree-based paradigm, there are alternative ways of explaining these structures without alluding to the notion itself. Take for instance what Atkinson (2001) has to say for unacceptable sentences like (8), repeated as (22).

(22) *there seem [[several people] are [friends of yours]]

Recall that for theories adopting defective intervention, this sentence is unacceptable because matrix T is left with a set of unchecked features that can be valued neither against the defective expletive (with only a person feature) nor the embedded object

⁹ The movement alternative presented in chapter 3 explains how lower absolutive objects move over higher ergative subjects and trigger agreement on the matrix verb. The analysis will not be repeated here.

friends of yours because of the intervening subject *several people*. Atkinson draws our attention to a different reason for its unacceptability. He points out that the embedded clause [*several people are friends of yours*] is a full CP or TP-clause. The potential goal *friends of yours* is already case-checked in the downstairs clause, so it is already inactive by the time matrix T initiates its search. The lower subject is also case-checked against embedded TP, which makes it ineligible for phi-agreement as well. Given this state of affairs, the unacceptability of (22) follows from the fact that there are no potential eligible-for-Agree goals in the structure. The expletive with a person feature is also apparently not good enough a goal for it. It checks its person feature against T, but fails to satisfy the featural requirements of the head in return. Matrix T is thereby left with unchecked phi-features, causing a derivational crash at the interfaces. Atkinson extends similar arguments to explain the unacceptability of structures like (23).

(23) *There seem there to be three men in the room.

Recall that Chomsky rules out (23) on the assumption that matrix T is prevented from checking its phi-set against the appropriate goal *three men* by the intervening expletive. The alleged intervener has an unchecked person feature that it fails to get valued against embedded infinitival (defective) T, since the latter's feature-set is already valued by *three men* at a prior derivational stage. A different solution is provided by Atkinson. In his understanding, what is required of Match is for the goal to bear a superset of the features of the probe. This is under the assumption that all DPs have an extra structural case *feature*, which is apparently never found on probes (24).

(24) Probe \subseteq Goal
 +Phi +Phi, + Structural case feature

Given this logic, the embedded expletive in (23) with its sole person feature cannot be considered as a goal for the matrix probe bearing a full set of phi-features. Match between these two items is not even a possibility. The expletive is neither an appropriate goal at the level of Match nor is it a defective intervener for a probe-goal relation between matrix T and the embedded DP. In fact, matrix T can keep searching for a goal until it hits upon the embedded argument and triggers agreement with it. Therefore matrix T has no unvalued features that could possibly cause the derivation to crash. The unacceptability of (23), Atkinson then argues, is not due to defective intervention caused by the intervening expletive, but triggered by the non-interpretable person feature on it. Since the expletive is not chosen as a goal for a probe, its feature remains unvalued, ultimately causing the whole structure to crash at the interfaces.¹⁰

To summarize, what Atkinson tries to demonstrate is that the notion of defective intervention is an undesirable postulation even within Agree-based theories. There is in fact very little empirical proof to back it up and even those that have been hitherto been presented in its favor are not critical enough. That said, Atkinson's theory has some loopholes that merit some discussion here. Let me begin with some of the default agreement cases in English expletive-associate constructions. Consider the following

¹⁰ It is unclear from Atkinson's work if the person feature on matrix expletive also remains unvalued and accelerates derivational non-convergence.

sentences from Hornstein and Witkos (2003), which show T hosting default third person singular phi-value.

(25) ?There seems to be men in the room

(26) There is a cat and a dog on the roof.¹¹

Matrix heads in both these sentences take values that do not concur with the phi-values of the associates. Whatever be the reason behind that (see below for a possible explanation), sentences like (25) and (26) indicate that the features on T may survive with default values. Default values, judging by the acceptability of these sentences, seem sufficient to avoid a crash at the interfaces. If true, it is doubtful if Atkinson's claim that (22) is bad due to the impossibility of matrix T receiving the associate's phi-values can be maintained any longer. There is no principled explanation for why T in this structure cannot similarly escape a derivational crash by acquiring default values for its phi-features.

It is also worth pointing out here that predicate nominals are generally unacceptable in expletive-associate constructions. A representative example is given below.

(27) *There is someone a sick man.¹²

¹¹ As opposed to the following sentences:

(i) (Some) men are/*is in the room.

(ii) A cat and a dog are/*is on the roof.

¹² As opposed to (i), which presents a temporary state/stage of sickness for someone/John.

(i) Someone/John is a sick man. (Thanks to Howard Lasnik for help in constructing these sentences.)

As far as there is a general ban on predicate nominals from appearing in expletive-associate constructions, the unacceptability of (22) is not surprising. It is disqualified for the same reason used to rule out (27). Defective intervention therefore need not be appealed to, to handle such cases.

The second problem lies with Atkinson's conception of the prerequisites for Match. According to him, a goal's features must constitute (at least) a superset of the features on the probe. This is however based on the assumption that structural case is a feature. A standard assumption in the literature is that case is not a feature (like phi-features: person, number and gender). It simply acts to keep a nominal active for phi-computations. Observe that once we assume that structural case is not a feature, we can no longer hold on to Atkinson's claim that goals always have larger phi-sets than their probes. With this modification, an expletive with just a person feature becomes an equally legible goal for Match, making Atkinson's analysis for (23) very doubtful. Matrix T in this sentence must in principle, be allowed to Match with the expletive, even though its person feature remains insufficient to check the complete phi-set on the probe.

That said, it could be that (23) is ruled out by a PF constraint that prohibits homophonous elements from appearing too close to each other. In this particular case, the second expletive is within an infinitival clause, which possibly counts as part of the larger structure. If there is a general ban on not pronouncing homophonous elements within any given clause (TP/CP) in English, then we might have an alternative explanation for the

unacceptability of (23). Similar phonological constraints have been previously observed for multiple wh-fronting languages like Serbo-Croatian (see Boskovic 2002 among others). I cite a few representative examples below:

(28) Sta uslovljava sta?

What conditions what?

(29) *Sta sta uslovljava?

What what conditions?

Serbo-Croatian is a multiple wh-fronting language. Movement of all wh-elements to a clause-initial position is obligatory, unless they are homophonous. In such cases, one of them must remain in situ (28). Moving both of them generates unacceptable results (29). In English on the other hand, if I am right, the ban is on realizing homophonous elements within the same clause. Expletives embedded inside infinitivals are considered as belonging to the matrix clause, and by virtue of that, cannot be spelled out at the same time as the highest expletive. Notice that multiple expletives may co-exist in the structure as long as the second is embedded inside another CP or PP clause (30). I come back to discuss such structures in the next section, but suffice it to say that the contrast between (23) and (30) shows that the unacceptability of (23) cannot be due to intervention caused by intermediate expletives. Otherwise, there is no way to explain how English generates sentences like (30).

(30) There seem as if there are problems.

There are two other important points worth emphasizing here with respect to expletive-associate constructions. First, it has been claimed in the literature that expletives check their structural case or EPP against T while associates receive partitive case in their base-generated positions (Belletti 1988, Hazout 2004; Lasnik 1992, 1995).¹³ That expletives require structural case is evidenced by the contrast observed between (31) and (32).

(31) *[There to be a unicorn in the garden] would be a surprise

(32) [For there to be a unicorn in the garden] would be a surprise.

Sentences (31) and (32), taken from Hazout (2004) show that the expletive *there* is impossible inside an infinitival unless supported by a *for*-complementizer. The unacceptability of (31) is straightforward if we assume that expletives require case that they cannot receive from an infinitival T.

Secondly, Chomsky assumes that expletives carry a non-interpretable person feature. However, given that they are potential goals for agreement, it is reasonable to assume that they pattern alike with other nominal expressions in bearing interpretable phi-values. Therefore, I will assume that they are defective in that they carry only a person feature, but this feature is *interpretable*. I will overlook the repercussions that this might hold for Atkin's proposal and instead proceed directly to another possible way of handling defective intervention in English expletive-associate constructions.

¹³ Lasnik (1992) actually shows that partitive for associates is assigned against an AgrO head.

4.3 English Expletive-Associates: Another Approach

To start, I assume (on the lines proposed by Hornstein and Witkos (2003)) that expletives originally start off as adjoined to the associate, as shown in (33).¹⁴

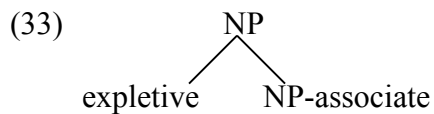

In a simple expletive associate construction like (34), the complex DP moves to the specifier of vP, and then the expletive moves over to the specifier of TP for case and phi-checking. See (35).

(34) There are men in the garden.

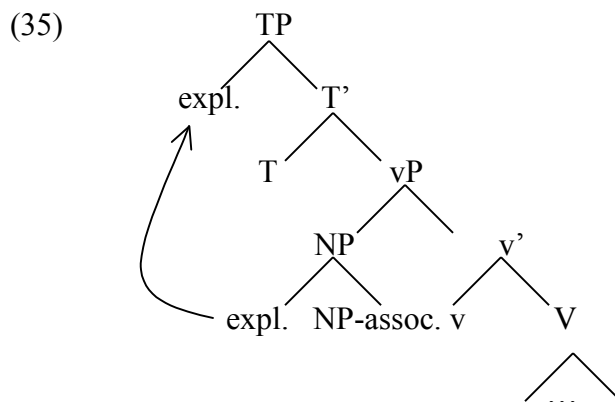

¹⁴ In this sense, expletive-associate pairs resemble left dislocated structures derived by movement (see Aoun, Chourieri and Hornstein 2001; Chandra 2004). According to these authors, the left dislocated item starts off adjoined to the strong pronoun or the epithet phrase and later targets a matrix clause position. The adjoined structure is interpreted as an appositive (Kim 1997). Also see Hoekstra and Mulder (1990), Williams (1994), Hazout (2004) among others for suggestions that the expletive is base-generated as sister to the associate (whereby it inherits the features of the latter) and Moro (1991; 1997) for arguments for a small clause analysis of English expletive-associate sentences.

I also assume that the expletive carries with itself either its (interpretable) person feature or inherits the phi-value of its associate when it adjoins to the latter. In more concrete terms, there is an optional concord relation between the two phrases when they base-generate adjoined to each other. If the expletive carries the phi-set of its associate, T must display the phi-value of the ‘stranded’ NP. The sentence in (34) illustrates one such case. On the other hand, optional agreement in expletive associate constructions results when the expletive carries its sole person feature. Since T’s phi-set remains unvalued by the incomplete phi-set on the expletive, the head is forced to take default values. The case on the expletive nonetheless receives a value from the non-defective T in the process. This is what we find in structure like (25)-(26).¹⁵

Against this backdrop, let us reexamine some of the purported evidence for defective intervention again. Let us begin with (23), repeated as (36).

(36) *There seems there to be three men in the room.

I assume that the expletive is merged with the associate *three men* and then moved to the specifier of infinitival TP-2. See (37) below. However since this is not a canonical position for structural case checking, the case on the expletive remains unchecked at this

¹⁵ Some speakers reject optional agreement. I assume that for them, only the first mechanism, whereby the expletive receives the phi-value of its associate in a local, sisterhood relation, applies. For those speakers who allow optional agreement, there are two options. The first we have already mentioned; there is no concord between the two items and the expletive moves along with its person feature. There is a second option, based on the ideas of Basilico (1997) who argues that *there* is a topic quantifier with the small clause associate providing the restriction for it. If true, we can claim that for the second set of speakers, the expletive is a topic that does not have an unvalued case to check against T. Instead, the topic expletive moves directly to the specifier of CP. T is then forced to take default values.

derivational point. It must target a position in the higher clause. It then targets a position in the matrix clause, the specifier of TP-1. Schematically (37):

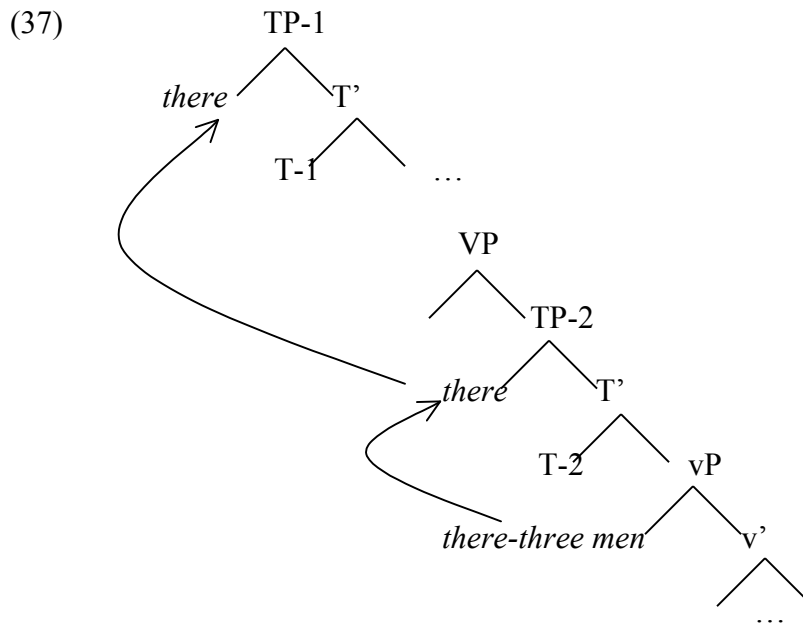

Under the alternative analysis given here, there is no syntactic reason for ruling out (37). Rather, as I have already alluded to in the previous section, multiple occurrences of expletives in matrix-infinitival bi-clausal structures are possibly eliminated at PF, under the assumption that PF cannot pronounce homophonous copies within what it takes as a single clause.¹⁶

A final note on structures like (12), repeated below in (38). Structures like these motivated Boeckx and Jeong (2003) to claim that intervention is always direct, and triggered only when intervening items carry features identical to those on the potential

¹⁶ By making this proposal, I am not in any way suggesting that homophonous copies are never pronounced in the same clause. However they must be made distinct somehow, either by focus or stress.

goal they c-command. Since the intermediate expletive bears only person feature, under their account, it follows that it cannot intervene agreement between matrix T and the embedded associate *two men*.^{17,18}

(38) There look as though there are two men in the room.

Fujii (2005) provides a movement analysis for these multiple expletive constructions with *as though, as if, like* complementizers¹⁹ and I generally follow him on that. Extending on the ideas of Hornstein and Witkos, Fujii claims that expletive *there* in (38) base-generates in the lower clause and then moves to the specifier of matrix TP via the specifier of embedded TP. As part of the evidence provided for a movement analysis are sentences like (39).

(39) [Stories about each other-i]-j seem like [they-j have frightened John and Mary-i]

Sentence (39) with the psych predicate *frighten* allows for backward binding between *each other* and *John and Mary*. This is possible, Fujii argues, only when this sentence has the underlying representation in (40). The surface subject *stories about each other* base-generates inside the verb phrase (à la Hornstein and Motomura 2002) and moves up to

¹⁷ Some speakers completely reject such structures. Thanks to Heather Taylor for discussion.

¹⁸ These cases have also been discussed in Rogers (1974) and Potsdam and Runner (2001), among others.

¹⁹ I come back to discuss more on the actual status of these particles later

the specifier of TP. The anaphor inside the moving argument is A-bound by the embedded subject *John and Mary*.²⁰

(40) ... seem like [TP [stories about each other-i]-j T [VP t-j frighten [VP John and Mary-i t-frighten t-j]]]

Also worth noticing is the contrast between the following sentences in (41) and (43). The former is unacceptable with a DP *Jane* intervening between *there* and its associate *a unicorn*. Notice that the sentence is fine when there is no such DP, as is illustrated by (42). As opposed to (41), sentence (43) has an intervening *Jane* that does not cause unacceptability. The difference between (41) and (43) can be explained if one assumes that only in (41) does *there* move from an embedded clause position to a matrix clause A-position. Since *Jane* occupies a possible A-landing site for the expletive, crossing over it leads to a minimality violation. In (43) on the other hand, *Ted* base-generates in the matrix clause. Therefore the presence of an intervening A-element or its absence has no effect on the derivation of the sentence.²¹

²⁰ Similarly in sentences like (i), which has the underlying representation in (ii).

(i) Each other's mothers seem [t to please the two boys]

(ii) seem [the two boys please each other's mothers]

²¹ Potsdam and Runner (2001) presents evidence from reconstruction effects for a base-generation analysis for structures like (43). Some relevant examples are given in (i) and (ii).

(i) Two people seem like they have won the lottery

*seem > 2, 2 > seem

(ii) Two people seem to have won the lottery.

seem > 2, 2 > seem

In (i), a seem-like construction, the matrix subject *two people* fail to scope below *seem*, suggesting that it never held a position in the embedded clause. Compare this to the sentence in (ii) which is ambiguous with the matrix subject taking either wide or narrow scope vis-à-vis the predicate *seem*.

(41) *There-i seems like Jane expects there-i to be a unicorn in the garden.

(42) There-i seems like there-i is likely to be a unicorn in the garden.

(43) Ted looks like Jane has been hassling him again.²²

(44) is then the underlying structure for multiple expletive constructions like (38). The expletive base-generates adjoined to the associate *three men* and then moves over to the specifier of TP-1 for case. En route, it moves via the specifier of TP-2, where it also checks the phi-set on T-2.

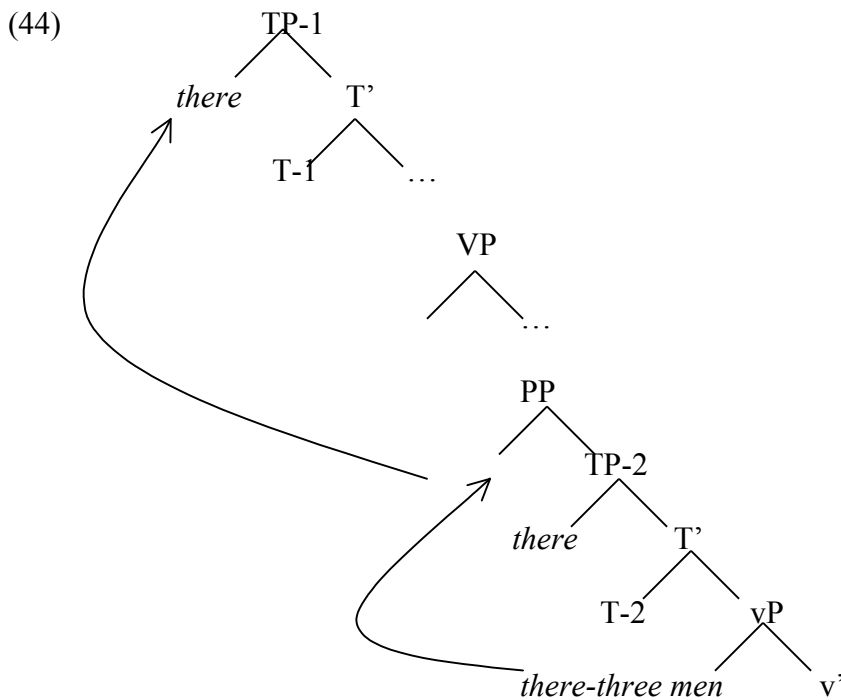

²² Fujii credits Postal (1974) with this sentence.

That said, I depart from Fujii on one issue. He adopts Bejar and Massam's (1999) theory of multiple case-checking for these multiple expletive constructions. In his opinion, the expletive gets a case-value from embedded T-2 after which it moves to the specifier of matrix TP for a second case-value. This leads him to reject the Activation Condition. As opposed to Fujii, I argue that the embedded T in these constructions is defective and cannot case-value the expletive. Therefore when the expletive moves to the matrix clause, its movement is driven by the requirement to check case, which it is unable to do within the complement clause. The evidence for my claim comes from degraded sentences like (45) and (46).

(45) ?? There seems like a serious problem is remaining to be solved

(46) ?? There seem like serious problems are remaining to be solved

These structures are worse than their multiple expletive counterparts. Compare them with (47) and (48).²³

(47) There seems like there is a serious problem remaining to be solved.

(48) There seem like there are serious problems remaining to be solved.

The unacceptable (45) and (46) show that embedded TPs in *seem like* constructions cannot license overt nominals like *serious problem*, suggesting that they are defective and ineligible structural case-checkers. If true, then expletives also cannot get case-valued

²³ Thanks to Norbert Hornstein for the judgments.

inside embedded TPs. In other words, they are still active with an unvalued case when they target the specifier of matrix TP. I also follow Maling (1983), Heycock (1994) and Potsdam and Runner (2001) in assuming that *like, as though* etc. are prepositions and not CPs. An embedded expletive can move across these PPs to the specifier of matrix vP without causing any minimality violation, as the latter are devoid of phi-features. These PPs are complements to the main clause predicate. However since they lack phi-features, they are not eligible goals for the next functional head and thereby do not pose as potential barriers in the movement of a lower expletive.^{24, 25}

To summarize the main points of this section, I have revealed here the inconclusive nature of some of the evidence provided in support for the notion of defective intervention. I have also shown that there are existing, alternative explanations for these effects. More such cases of apparent defective intervention effects are brought up in the upcoming sections. But before I discuss them, let me briefly mention what I take to be the locality principle in grammar.

4.4 Shortest Dependency: Measuring Syntactic Distance

Eliminating the notion of defective intervention raises an important question, and one that directly concerns the present study. Recall that locality is built into the definition of

²⁴ As opposed to complement clauses headed by *that*, which prohibit hyperraising (i).

(i) *John seems that is a genius.

Fujii argues that *that* has phi-features, which renders the embedded CP itself as a potential goal for the next highest functional verb.

²⁵ I will claim that the PP counts as a separate domain from the main clause and hence a PF constraint barring homophonous elements from occurring in the same clause does not apply in such constructions.

Match/Agree, by which the closest DP is (in most cases) automatically declared the most eligible goal. Understandably, we cannot hold on to this idea of locality in phi-agreement once we eliminate Match, Agree and related notions from the theory. Locality in phi-agreement must then be obligatorily recast in terms of locality constraints on movement, the operation that I assume, underlies long distance agreement.

To this end, I follow Hornstein (2005) in assuming that the fundamental locality principle is Shortest Dependency, a general economy constraint that prefers shorter dependencies to longer ones. Distance is calculated in terms of ‘paths’ or the union of the sets of maximal projections dominating the target and the mover. Consider (49) in this regard, where α represents the target and β and γ two potential goals.

(49) [TP [T= α [vP β [VP γ]]]]

At the point of derivation represented by (49), α is dominated by the maximal projection TP, while β is dominated by the set of maximal projections {vP, TP}. The union of sets of maximal projections dominating the target α and the goal β is therefore {vP, TP}. γ is further away with the union of sets of maximal projections dominating it and the target α being {VP, vP, TP}. Since the path from β to α is a subset of the path between γ and α , economy considerations force us to choose the shortest dependency, thereby blocking the movement of the lower item γ . That said, there are certain circumstances where the lower goal γ may be allowed to target α without causing a minimality violation. They are listed below.

In the first situation, γ may target a different specifier of the same head that also hosts β , in which case these two items are placed at an equal distance from the target. Schematically:²⁶

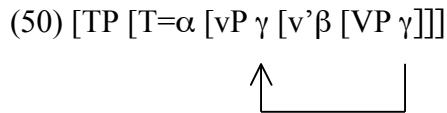

By targeting a second specifier of vP, γ is placed at the same distance from α as its rival β , i.e. the distance from α to both β and γ is {vP, TP}. Being equidistant, β and γ are rendered equally eligible to move to the target domain. Importantly however, the second specifier must be a potential phi-checking position (i.e. an A-position), otherwise the constraint on Improper Movement bars γ from moving over to the next A-position headed by α .

γ may also bypass β in situations, where both items target the specifiers of a higher head, as we witness in (51):



β is introduced into the derivation in a structurally higher position than γ . By Shortest Dependency, it is the closest goal to all higher heads. The head α has unvalued features

²⁶ Adjoining γ to vP will place it outside the domain of the phrase (as the latter fails to dominate it) and hence, closer to α .

that have to be checked against the phi-value of a nominal. β then raises to α 's specifier. Now imagine a situation where it fails to check α 's complete phi-set, possibly due to its defective nature (i.e. incomplete phi-set). The next step of the derivation involves moving the lower goal γ to the second specifier of the same head, culminating in phi-feature valuation for α . Both β and γ are then allowed to target the next highest head Ψ from this position since they are contained within the same minimal domain. A second and relevant point to note about (51) is that the γ need not target the specifier of vP-1 once β has moved out to the specifier of α P (or TP). The copy of β in the specifier of vP-1 is not considered while evaluating the path or distance between α and γ . The lower goal may therefore move over the copy of the otherwise intervening element.

I now proceed to discuss some more alleged cases of defective intervention, point out some problems with previous accounts before suggesting an alternative. First in line are the Japanese object honorification constructions.

4.5 Japanese Object Honorification²⁷

Japanese allows special honorification markers on verbs selecting objects that are Socially Superior to the Speaker (henceforth SSS). Consider the following sentences.^{28,29}

²⁷ The Japanese sentences are from Takahashi (2006), unless specially mentioned.

²⁸ I do not consider cases of subject honorification here.

²⁹ The phenomenon has found various explanations (cf. Toribio (1990); Niinuma (2003); Boeckx and Niinuma (2004); Bobaljik and Yatsushiro (2006); Boeckx (2006) and Takahashi (2006)). Below, I focus on Boeckx and Niinuma's defective intervention account.

- (52) Taro-ga Tanaka sensei-o o-yobi-si-ta
 Taro-nom. Prof. Tanaka-acc. call-OH-past.
 ‘Taro called Prof. Tanaka’
- (53) Taro-ga Tanaka sensei-o yon-da.
 Taro-nom. Prof. Tanaka-acc. call-past.
 ‘Taro called Prof. Tanaka’
- (54) Taro-ga Hanako-o yon-da.
 Taro-nom. Hanako-acc. call-past.
 ‘Taro called Hanako’
- (55) *Taro-ga Hanako-o o-yobi-si-ta.
 Taro-nom. Hanako-acc. call-OH-past
 ‘Taro called Hanako’

Socially superior objects (such as *Prof. Tanaka* in example (52)) may trigger special honorification morphology (*o-(~go)*) on the verb.³⁰ This is however not obligatory, as we

³⁰ Most researchers (including Niinuma 2003; Boeckx and Niinuma 2004 and Takahashi 2006) take *o-sita* to encode object honorification. Bobaljik and Yatshushiro (2004) however argue that the actual agreement marker is *o-(~go)* with *sita* acting as a light verb in the construction (also see Toribio 1990). They support their claim with the following pair of sentences.

- (i) [Tanaka-sensei-o o-tasuke]-sae Taro-ga si-ta.
 Prof. Tanaka-acc. OH-help-even Taro-nom. do-past.
 ‘Taro even helped Prof. Tanaka’
- (ii) *[Tanaka-sensei-o o-tasuke-si/su]-sae Taro-ga ta.
 Prof. Tanaka-acc. OH-help-even Taro-nom. past.
 ‘Taro even helped Prof. Tanaka’

The preposed vP/VP in (i) does not include *sita*, indicating that *si* is attached to a head outside the dislocated verb phrase. On the assumption that object honorification is triggered at the vP-level (see below for more), it is unexpected that the object honorification marker is left behind when the rest of the verb phrase is dislocated. *Sita* cannot be therefore considered as encoding object honorification. Furthermore, the morpheme itself is apparently composed of two different morphemes *si* (*do*) and *ta* (encoding tense). Stranding one behind produces unacceptable results, as evidenced by (ii). I will therefore assume that the former is a light verb that must eventually adjoin to T, possibly to support the tense affix.

find in sentences like (53). Sentence (54) confirms that only SSS DPs can trigger honorification. The object *Hanako*, for instance does not fit the description of an SSS DP and hence cannot trigger honorification, as shown by (55).³¹

Importantly, object honorification is not restricted to direct objects. Indirect objects (IOs) are equally suitable triggers for object honorification, as substantiated with some relevant examples below (56)-(59). IOs triggers are either dative (*ni*) case-marked objects (56), or PPs like ‘from’ (*kara*)-DPs (57), ‘with’ (*to*)-DPs (58) and ‘to’ (*e*)-DPs (59).³²

(56) Hanako-ga Tanaka sensei-ni Taro-o go-shookai-si-ta.

Hanako-nom. Prof. Tanaka-dat. Taro-acc. introduce-OH-past.

‘Hanako introduced Taro to Prof. Tanaka’

(57) Taro-ga Tanaka sensei-kara hon-o o-kari-si-ta

Taro-nom. Prof. Tanaka-from book-acc. borrow-OH-past

‘Taro borrowed the book from Prof. Tanaka’

(58) Taro-ga Tanaka sensei-to kabuki-ni tuite o-hanasi-si-ta

Taro-nom. Prof. Tanaka-with stock prices-about talk-OH-past

‘Taro talked with Prof. Tanaka about stock prices’

(59) Taro-ga Tanaka sensei-e hon-o o-okaru-si-ta

Taro-nom. Prof. Tanaka-to book-acc. borrow-OH-past

‘Taro send the book to Prof. Tanaka’

³¹ Note that it is not that non-SSS animate objects cannot trigger honorification. Rather, these structures (eg. (55)) are semantically odd since DPs like *Hanako* are not SSS in the usual sense of the term.

³² The morpheme *ni*- is also ambiguous between a dative case-marker and a postposition, as noted by Miyagawa (1997), Miyagawa and Tsujioka (2004) and Jeong (2006).

In structures where direct and indirect objects co-exist, only the latter may trigger honorification agreement. Object honorification by direct objects is limited to transitives, a fact first noticed by Harada (1976), to whom the following generalization is due:

(60) Object Honorification Marking

Mark the predicate as [Object Honorification] when a Socially Superior Person to the Speaker (henceforth SSS) is included in

(a) the indirect object, if the predicate is ditransitive, or

(b) the direct object, if the predicate is transitive. (Harada 1976:530)

The restriction on direct object triggered honorification holds in all constructions hosting double objects, irrespective of whether the indirect object itself triggers object honorification or not:

(61) Hanako-ga Tanaka sensei-ni Taro-o go-shookai-si-ta.

Hanako-nom. Prof. Tanaka-dat. Taro-acc. introduce-OH-past.

‘Hanako introduced Taro to Prof. Tanaka’

(62) *Hanako-ga Taro-ni Tanaka sensei- o go-shookai-si-ta.

Hanako-nom. Taro-dat. Prof. Tanaka-acc. introduce-OH-past.

‘Hanako introduced Prof. Tanaka to Taro’

Honorification in (61) is controlled by the indirect object. This is expected since the IO is the sole SSS argument in the sentence that can control honorification on the verb. What is unanticipated however is the blocking effect caused by the non-SSS IO in (62). The SSS direct object – a perfect candidate for honorification – fails to trigger honorification on the ditransitive verb across the intervening non-SSS IO. Importantly, word order changes – as those brought about by scrambling – do not affect honorification patterns. DOs that precede IOs also fail to trigger honorification, as attested in (63).

- (63) *Hanako-ga Tanaka sensei-o Taro-ni go-shookai-si-ta
Hanako-nom. Prof. Tanaka-acc. Taro-dat. introduce-OH-past
'Hanako introduced Prof. Tanaka to Taro'

However there are certain contexts where a DO may trigger honorification even in the presence of an intervening IO. Consider (64) for instance, where the dative IO *audience* fails to intercede honorification with the lower object *teacher*. A parallelism with indirect objects may hold the key to this peculiar behavior of some IOs. As has been observed in the literature (see Jeong 2006 for an elaborate discussion), inanimate objects (direct or indirect) surface lower than animate objects in Japanese, as illustrated in sentences (64) to (66).³³ The animate IO in (65) precedes the inanimate DO *package* and the inanimate IO *Tokyo*. Reversing the order by allowing one of the inanimate objects to surface before the animate object yields unacceptable results, as shown by the degraded status of (66) and (67).

³³ The examples are from Jeong (2006) who in turn credits them to Miyagawa and Tsujioka (2004)

(64) Watasi-ga tyoosyuu-ni sensei-o go-syookai-si-masu

I-nom. audience-dat. teacher-acc. introduce-OH-pres.

‘I’ll introduce the teacher to the audience’

(65) Taroo-ga Hanako-ni nimotu-o Tokyo-ni okutta.

Taro-nom. Hanako-dat. package-acc. Tokyo-to sent.

‘Taro sent Hanako a package to Tokyo’

(66) *Taroo-ga Tokyo-ni Hanako-ni nimotu-o okutta.

Taro-nom. Tokyo-to Hanako-dat. package-acc. sent.

(67) */?Taroo-ga nimoto Hanako-ni Tokyo-ni okutta.

Taro-nom. package-acc. Hanako-dat. Tokyo-to sent.

Based on these sentences, it is reasonable to conclude that animate nominals generate higher than inanimate objects in Japanese. Similarly, the IO in (64) patterns like inanimate objects and possibly generates lower in the structure, which explains why it fails to intercede object honorification. The DO in this case is the highest item visible to the honorification checking head. The surface order in (64), with the IO preceding the DO is obtained by IO scrambling, which as I have already alluded to, fails to influence honorification. On the other hand, those IOs that cause intervention must be base-generated higher up in the tree, a matter to which I now turn to, in the context of Boeckx and Niinuma’s (2003) account for object honorification in Japanese.

4.5.1 Boeckx and Niinuma (2003)

The main thesis of Boeckx and Niinuma is that indirect objects base-generate higher than direct objects, which make them closer goals for the verbal head that triggers honorification agreement. The intervening object may or may not be an SSO, but it matches the features on the probe and hence counts as a potential goal at the level of Match. Schematically (68):

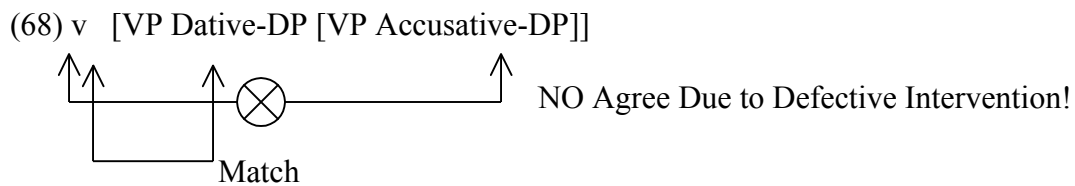

Recall that intervention can be caused only when the intervener occupies a position in the c-command path between the probe and a lower, potential goal. Intervening IOs in Japanese indeed meet this specific requirement, as is illustrated by the following examples.

(69) [Yamamoto-sensei to Tanaka-sensei-ni (wa)]-i otagai-i-ga hihan-deki-ru

Prof. Yamamoto and Prof. Tanaka-dat(top) each other criticize-can-pres.

‘Prof. Yamamoto and Prof. Tanaka can criticize each other’

(70) Watasi-ga [Taro-kara]-i [kare-zishin-no]-i hon-o kari-ta

I-nom. Taro-from him-self-gen book-acc. borrow-past.

‘I borrowed Taro’s book from him’ (Lit. I borrowed himself’s book from Taro)

(71) ??Watasi-ga [Taro-kara]-i [kare-no]-i hon-o kari-ta

I-nom. Taro-from he-gen book-acc. borrow-past.

‘I borrowed Taro’s book from him’ (Lit. I borrowed his book from Taro)

The first sentence shows that dative (*ni*-marked) DPs (the subject here) can c-command and A-bind lower nominals (the reflexive object). The next two sentences in (65) and (66) show the same pattern with dative IOs, only this time bearing the *kara* case-morpheme. In the former, a *kara*-DP constitutes the antecedent of the reflexive contained inside the DO. The latter on the other hand, shows that if the reflexive is substituted with a pronoun, the sentence is ruled out as Condition B violation as the *kara*-DP ends up A-binding the pronoun.³⁴ To add these observations to the ones about animate IOs that I have already alluded to, the following picture emerges for Japanese objects. Animate objects must precede inanimate ones, and among the former, animate IOs must precede animate DOs. With evidence such as these, Boeckx and Niinuma contend that direct object triggered honorification is impossible in Japanese ditransitives since IOs (both SSS and non-SSS nominals) base-generate higher than DOs and thereby constitute potential goals for the verbal head at the level of Match. *v* terminates its search on meeting the IO, and hence cannot seek the lower object for honorification. If the IO turns out as SSS, the derivation proceeds to the next step where Agree ensues between these two items (72). Otherwise, the verb remains unvalued.

³⁴ Similar patterns with *ni*-IOs are slightly murky and I leave them out of the present discussion. There is also some dialectal variation on structures like (i), with Bobaljik and Yatsushiro (2004) completely ruling them out and Takahashi (2006) attributing them an odd status.

(i) %Taro-ga [Yamamoto sensei to Tanaka sensei]-i-kara otagai-i-no hon-o karita-
Taro-nom. Prof. Yamamoto and Prof. Tanaka from each other-gen. book-acc.borrow-past
‘Lit. Taro borrowed each other’s book from [Prof. Yamamoto and Prof. Tanaka]’

I do not have an account here for why some speakers find (i) unacceptable.

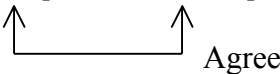
(72) v [VP Dative-DP [VP Accusative-DP]]

Crucially though, the object honorification morphology shows up on the lexical verb. To see this, consider the following sentences from Yatsushiro (1999); also see Bobaljik and Yatsushiro (2004).

(73) [Lina-o o-mise]-sae Kai-ga Tanaka-sensei-ni si-ta.

Lina-acc. OH-show-even Kai-nom. Prof. Tanaka-dat. do-past.

‘Kai even showed Lina to Prof. Tanaka’

(74) *[Lina-o mise]-sae Kai-ga Tanaka-sensei-ni o-si-ta.

Lina-acc. show-even Kai-nom. Prof. Tanaka-dat. OH-do-past.

‘Kai even showed Lina to Prof. Tanaka’

Japanese allows VP-preposing as shown in (73), where the direct object is dislocated along with the verb bearing the honorification marker. Significantly, the indirect object – that triggers object honorification in this sentence – does not dislocate with the rest of the verb phrase. Furthermore, the honorification marker must always accompany the preposed verbal head. It cannot be stranded behind, as illustrated by the unacceptable (74). This raises a potential problem for (72). If v is the agreeing head, then (73) must involve moving the entire vP with the honorification marker. However since the agreement trigger, the IO, is located inside the vP, it is not immediately clear how it can be stranded behind when the vP containing it is dislocated. Notice that there are potential

ways of getting out of this dilemma. The first solution is provided by Boeckx (2006), where he posits a root v (in the sense of Marantz 2000) in addition to a functional, verbal (*suru*) head that Agrees with the closest object in honorification. He then allows featural transmission between the two heads (as in Collins 2002). Under this approach, it is the root VP that is preposed, which explains why the IO can be stranded behind. The second is to assume that IO obligatorily moves to a position higher than the maximal projection of the honorification triggering head, namely vP in Boeckx and Niinuma's system. For the sake of discussion, let us assume that this is achieved by scrambling the IO to a position μP as in (75).

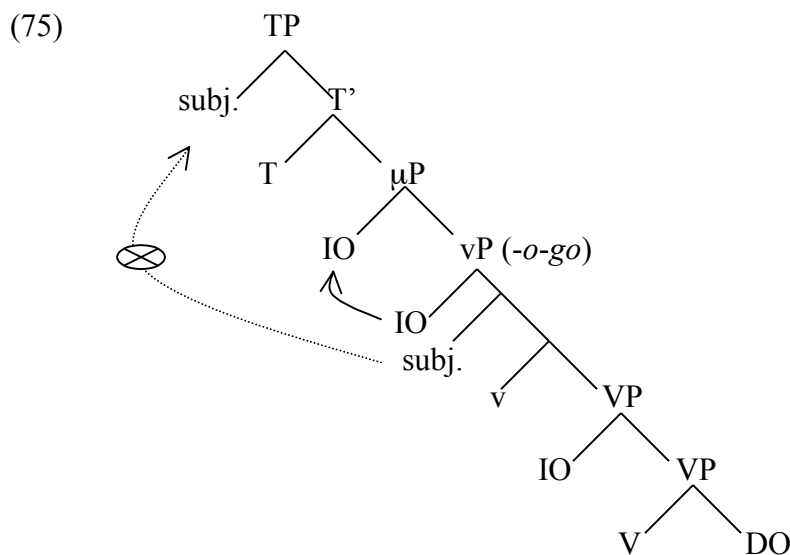

Once the IO is scrambled as shown in (75), the rest of the vP can be preposed, stranding it behind. But a different problem emerges at this point. If the IO targets what I have denoted as μP , the subject cannot cross over it to the specifier of TP (for case and EPP) without causing minimality violations. That would ultimately (and incorrectly) lead to a

non-convergent derivation, with the subject carrying its unvalued structural case to the interface. Even if the subject were to adjoin to μ P or move to a second specifier of the head, it will be disallowed from targeting the specifier of TP by constraints on Improper Movement. Its intermediate step is not undertaken for phi-feature considerations, and thereby counts as an A-bar site. The subject DP would henceforth be disallowed to target higher A-positions.

In a nutshell, to get all the facts right, a featural transmission mechanism is crucial to an Agree-based account, whereby the functional head can pass on its feature-values (pertaining to honorification) to the lower lexical head. Otherwise, it is necessary to have the IO move out of the vP, in which case it might intercede further A-movement for the subject. In what follows, I will try to reanalyze the same facts through a movement alternative without appealing to any of the above-mentioned mechanisms.

4.5.2 Alternative Analysis

I begin with a ditransitive sentence like (76), with its representative given in (77).³⁵

(76) Hanako-ga Tanaka sensei-ni Taro-o go-shookai-si-ta.

Hanako-nom. Prof. Tanaka-dat. Taro-acc. introduce-OH-past.

‘Hanako introduced Taro to Prof. Tanaka’

³⁵ For a different structure for Japanese ditransitives (i), see Pylkkänen (2002) and Jeong (2006). As opposed to (77), both IO and the DO in their account base-generate within the low applicativephrase.
 (i) [vP v° [VP V° [LAppIP IO [LAppI° DO]]]]

(77)

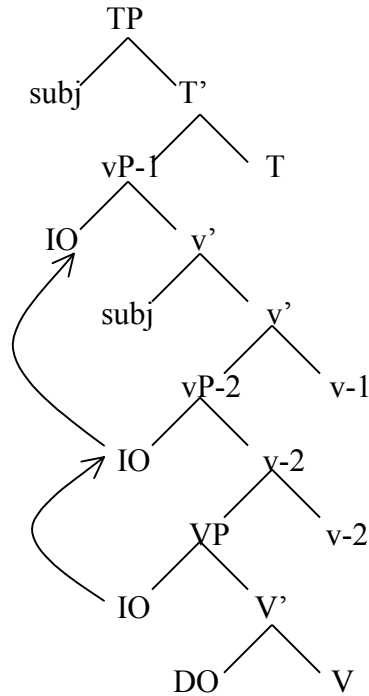

As in (77), both direct and indirect objects are base-generated within VP, which is itself selected by v-2 that I assume is the locus for honorification agreement. I also assume that the IO in (76) must move to the specifier of vP-1 where it receives a dative case value. This movement proceeds via the specifier of vP-2, where the IO ends up valuing the phi-set on v-2. The resultant structure is (76) with the IO-triggerred honorification. There are three immediate questions to solve here. First, can we still account for the VP-preposing facts without appealing to a mechanism like feature transmission? Second, what motivates the IO to move further up the tree, i.e. why can't the IO receive a case from v-2? Third, how does the object satisfy its case-requirements? I take up these questions one by one below.

Let us begin with the vP/VP-preposing facts in (73) and (74). Recall that Japanese allows the direct object and the verb (carrying the honorification marker) to dislocate, leaving the indirect object or the honorificaiton trigger behind. Under my approach, there is a straightforward explanation as honorification by the indirect object is triggered against v-2, while its final landing site is the specifier of vP-1. The honorification trigger is therefore outside the domain or phrase containing the honorification bearing head and the direct object. This phrase may therefore be preposed to the exclusion of the indirect object. Schematically:

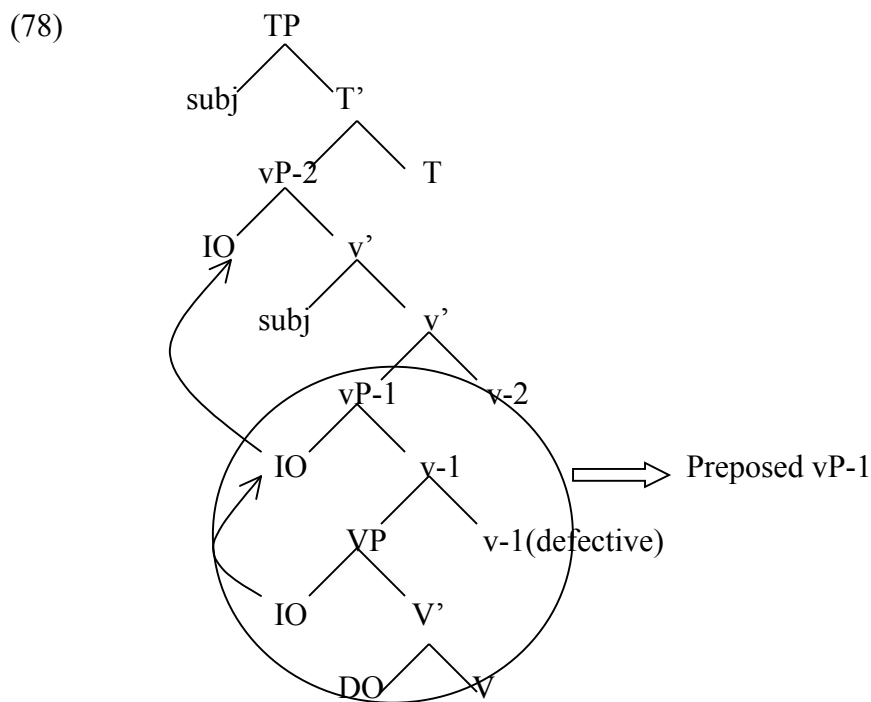

Let us now try explaining the following structures. In (79)-(80), the preposed structure includes both (indirect and direct) objects. In (81), the IO is excluded from the preposed

constituent, very similar to the cases we just saw in (78). (82) is interesting for a different reason. It shows that unlike the IO, the DO can never be left behind.

(79) [Tanaka sensei-ni Lina-o o-mise]-sae Kai-ga si-ta

Prof. Tanaka-dat. Lina-acc. OH-show-even Kai-nom. do-past.

‘Kai even showed Lina to Prof. Tanaka

(80) [Uli-ni Erika-o mise]-sae Kai-ga si-ta.

Uli-dat. Erika-acc. show-even Kai-nom. do-past.

‘Kai even showed Erika to Uli’

(81) [Erika-o mise]-sae Kai-ga Uli-ni si-ta

Erika-acc. show-even Kai-nom. Uli-dat. do-past.

‘Kai even showed Erika to Uli’

(82) *[Uli-ni mise]-sae Kai-ga Erika-o si-ta

Uli-dat. show-even Kai-nom. Erika-acc. do-past.

‘Kai even showed Erika to Uli’

Under the double vP-layered approach to Japanese ditransitives, structures like (79)-(80) and (81) are derived by moving the higher and lower vPs respectively as shown in (83). When vP-1 is preposed, we take along the IO with the rest of the verbal phrase containing the direct object and the verb, giving us (79) and (80). Targeting vP-2 on the other hand gives us (81), with the stranded IO. Finally, the reason (82) is unacceptable is because the

DO never moves beyond vP-1. Hence preposing any of the vPs obligatory coincides with DO-dislocation.^{36, 37}

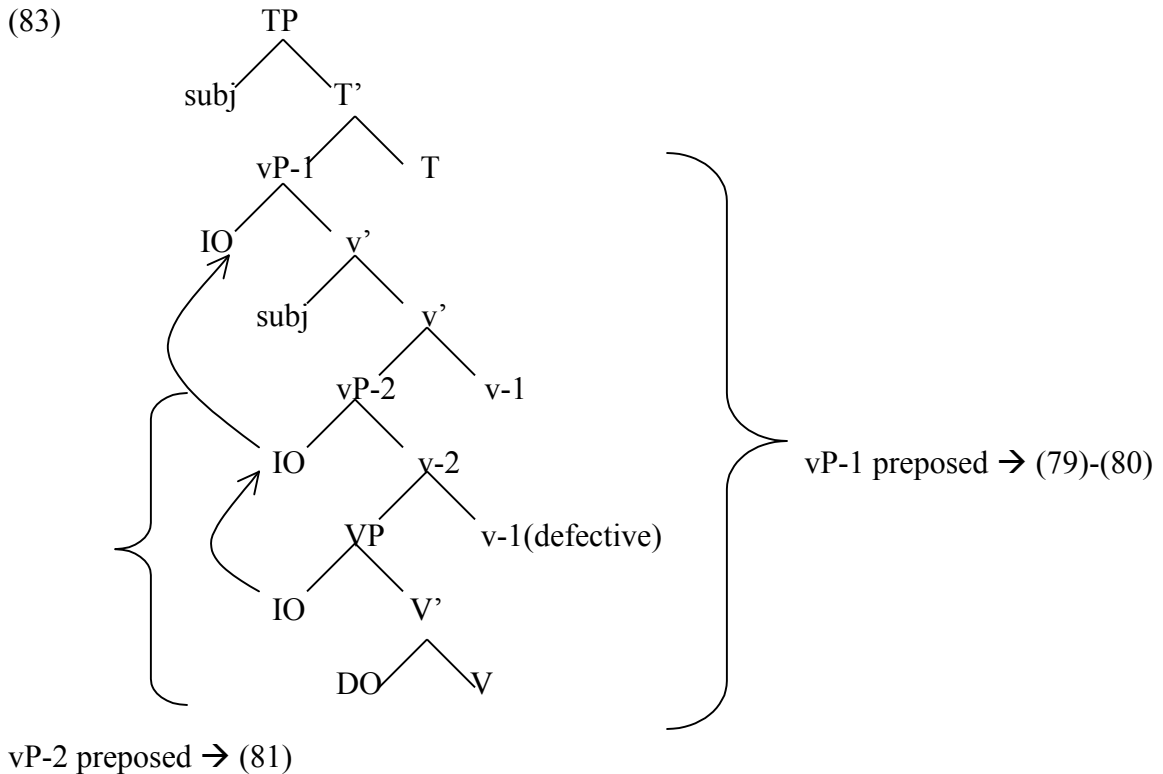

Let us now address the second question. What motivates the IO from targeting a specifier of vP-1 when it already enters into an agreement relation with v-2? I will claim here that

³⁶ Note that since v-2 bears the honorification marker, we cannot prepose VP while stranding the *o(-go)* affix. The unacceptability of (i) bears testimony to this fact:

(i) *[Lina-o mise]-sae Kai-ga Tanaka-sensei-ni o-si-ta.
 Lina-acc. show-even Kai-nom. Prof. Tanaka-dat. OH-do-past.
 ‘Kai even showed Lina to Prof. Tanaka’

³⁷ Bobaljik and Yatshushiro (2006) argue that the honorification marker is on the lexical verb itself, which comports well with their general view that honorification is different from phi-agreement (contra Boeckx and Niinuma’s (2003) claim). Apart from the fact that they fail to provide an alternative (see Boeckx 2006 for criticism), they also fail to explain why honorification is impossible with a direct object in the presence of an indirect object. Since the former is a complement to the verb and is introduced before the latter, we expect (of course incorrectly) SSS objects to always trigger honorification, irrespective of the presence or absence of IOs.

IO's movement is motivated for case-reasons. The head *v*-2 (the locus of honorification in Japanese ditransitives) is defective. Being phi-incomplete, *v*-2 cannot assign a value to IO's structural case, which forces it to target the next highest head (*v*-1) for case.³⁸ The IO checks off the person feature on the head, but cannot get a case-value from it. That brings us to the next question; where do direct objects check their case? I propose that direct objects receive a default accusative case in such constructions. Independent evidence for default accusative in Japanese comes from the sentences like the following (originally provided in Shibatani 1977; Kuroda 1979). In (84), the indirect object is the surface subject with a nominative case-value. What is interesting about this passive sentence is that the direct object still surfaces with an accusative case. This suggests that accusative can be assigned as a default in those constructions where the object fails to receive a structural case value from another source. Notice that the direct object can also move to the subject position, as shown in (85). In such cases, the indirect object remains in situ with a dative case.^{39,40}

³⁸ In case *v*-1 is defective, IO either moves to the specifier of TP for case (as in passives, see (i)) or its case is valued by inserting a preposition. This might explain why PPs headed by *kara*, *to* and *e* cannot be passivized, see (ii)-(iv).

- (i) Tanaka sensei-I-ga (Taro-ni yotte) zibun-i-no hon-o watas-are-ta
 Prof. Tanaka-nom. (Taro-by) self-gen book-acc. pass-pass-past.
 'Lit. Prof. Tanaka-i was passed self's-i book by Taro'
- (ii) *Tanaka sensei-i-kara (Taro-ni yotte) zibun-ii-no hon-ga karir-are-ta.
 Prof. Tanaka-from (Taro-by) self-gen book-nom. borrow-pass-past.
 'From Prof. Tanaka-i was borrowed self's-i book'
- (iii) *Tanaka sensei-i-to (kinoo) (Taro-ni yotte) zibun-i-no shorai-ga girons-are-ta
 Prof. Tanaka-with yesterday Taro-by self-gen future-nom. discuss-pass-past.
 'Lit. With Prof. Tanaka-i was discussed self's-i future by Taro yesterday'
- (iv) *Tanaka sensei-i-e (Taro-ni yotte) zibun-i-no shorui-ga okur-are-ta
 Prof. Tanaka-to (Taro-by) self-gen. document-nom. send-pass-past.
 'Lit. To Prof. Tanaka-i was sent self's-i documents by Taro'

³⁹ See Terada (1990) for the idea of inherent accusative case in Japanese.

⁴⁰ Which is not to say that accusative is always inherent in Japanese (see Takahashi 2006 for more).

(84) Tanaka ga zaidan ni yotte Nooberu syoo o atae-rare-ta.

Taroo-nom. foundation by Nobel prize-acc. award-pass-past

‘Tanaka was awarded the Nobel prize by the foundation.’

(85) Nooberu syoo ga zaidan ni yotte Tanaka ni atae-rare-ta.

Nobel prize-nom. foundation by Tanaka-dat. award-pass-past

‘The Nobel prize was awarded to Tanaka by the foundation.’

We are now ready to address Harada’s Generalization within the alternative movement analysis. The main problem is that since both objects base-generate inside VP, they are equidistant from the next highest verbal head (v-2). What prohibits the direct object from targeting its specifier in the presence of an indirect object?

As illustrated in (86), the union of the sets of maximal projections dominating the target and both direct and indirect objects is {VP, vP-2}. By this logic, the DO must in principle be able to move across the IO to the specifier of vP-1 and trigger honorification agreement against it. For sake of discussion, assume that such a step actually takes place. The DO targets the specifier of vP-2 over the IO. This is a perfectly licit step since both are contained within the same phrase. The problem however arises when the IO wants to move over the DO to its case-checking position (namely the outer specifier of vP-1).

(86)

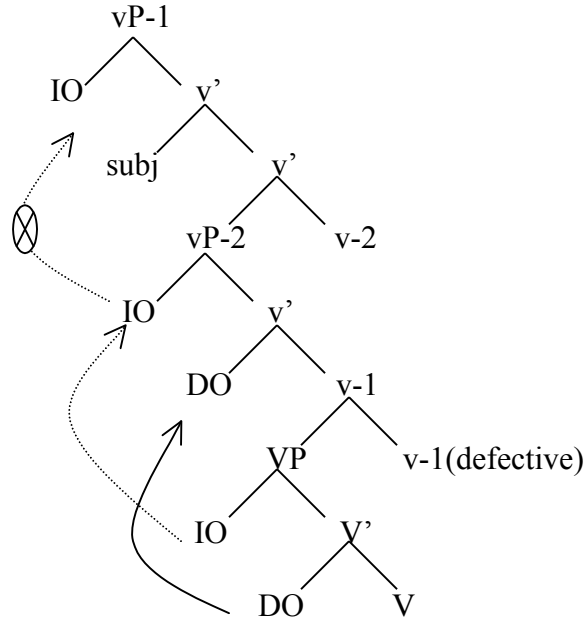

If the DO moves to the specifier of vP-2 checking off its person feature, the IO can move across it to the specifier of vP-1 either by targeting an outer specifier of vP-1 or by adjoining to it. Only then is the IO placed in the same minimal domain as the DO. The trouble comes at this point. Once the IO has moved to the specifier of vP-2, it is barred from undergoing further A-movement by the constraint on Improper Movement. Its landing site at vP-2 is an A-bar position since the head's person feature has already been valued at a prior derivational stage. IO's movement to this position is not triggered for phi-considerations and it is henceforth allowed to target only A-bar positions. However if the IO fails to move to vP-2, it ends up with an unchecked structural case, which ultimately causes the derivation to crash. That explains part of Harada's Generalization. Direct objects can never target vP-2 and trigger honorification in the presence of an IO since doing so leaves the latter with an unchecked case. However when there is no IO in the structure, as in (87), DO-movement to the specifier of vP produces a perfectly

legitimate structure (88). This movement is however optional, which also explains the optional nature of object-triggered honorification. For situations where there is no overt honorification, I will assume that the object receives a default accusative case-value in its base-generated position.^{41,42,43}

(87) Taro-ga Tanaka sensei-o o-yobi-si-ta

Taro-nom. Prof. Tanaka-acc. call-OH-past.

‘Taro called Prof. Tanaka’

⁴¹ Honorification triggered by nominative objects (i) must also take place at the vP-level. I assume that the nominative objects in Japanese are licensed by v, just like Icelandic nominative objects (see section 4.6).

(i) Taro-ni (paatii-ni) Yamada sensei-ga yob-e-ru (koto)
Taro-dat. (party-to) Prof. Yamada-nom. call-can-present (fact)
‘(The fact that) Taro can invite Prof. Yamada to the party’

⁴² The alternative analysis predicts that if the DO moves out of the VP instead of the IO, the latter remains in situ with a default accusative (as in (i)) or gets its case checked by a *ni*-preposition (ii). Our predictions are borne out by the following passive sentences.

(i) Taro-ga Hanako-o shokais-are-ta
Taro-nom. Hanako-acc. introduce-pass-past.
‘Taro was introduced Hanako’
(ii) Hon-ga Taro-ni yotte Tanaka sensei-ni kenjoos-are-ta
book-nom. Taro-by Prof. Tanaka-dat. give-pass-past.
‘The book was given to Prof. Tanaka by Taro’

⁴³ Object honorification is disallowed with passives and unaccusatives. (i) and (ii) are unacceptable with the honorification morphology *o-(-go)* while (iii) is good without it.

(i) *Tanaka sensei-ga sonohito-ni yotte o-nagur-ininar-are-ta
Prof. Tanaka-nom. that person-by hit-OH-pass-past.
‘Prof. Tanaka was hit by that person’
(ii) *Tanaka sensei-ga Mary-o Taro-ni yotte go-shokais-are-ta
Prof. Tanaka-nom. Mary-acc. Taro-by introduce-OH-pass-past.
‘Lit. Prof. Tanaka was introduced Mary by Taro’
(iii) Tanaka sensei-no otaku-ni John-ga sanjoo-si-ta
Prof. Tanaka-gen. house-dat. John-nom. come-OH-past.
‘John came to Prof. Tanaka’s house’

Niinuma (2003) suggests that object honorification is incompatible with passive *-rare*. The first two sentences must then be ruled out by a morphological constraint that disallows these two morphemes from co-appearing. The absence of object honorification marker in (iii) is probably for a syntactic reason. The underlying object of the unaccusative *John* must move to the specifier of TP for case and hence is expected to target the domain of v en route to its final landing site. It therefore checks off the person feature on the unaccusative v when it uses its specifier as an escape hatch. It is therefore not surprising that the PP cannot trigger honorification in such cases.

(88)

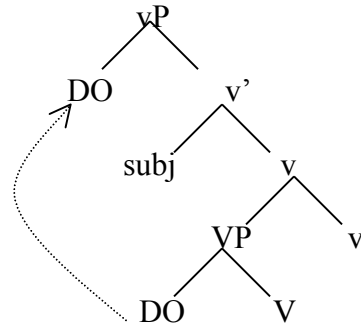

In a nutshell, I have demonstrated in this section that there is an alternative way of explaining Japanese object honorification. Object triggers move to the specifier of the appropriate verbal head in order to check off v 's feature that is morphologically manifested in the form of a honorification marker. In ditransitives, though both direct and indirect objects are placed at an equal distance from the head, moving the DO for honorification agreement is problematic as it forbids the IO from targeting a higher A-position for case. The unchecked case on the IO causes the derivation to crash at the interfaces. The sole option in Japanese ditransitives is understandably IO movement and IO triggered honorification.

In addition to Japanese, Icelandic raising constructions have also been used to defend the notion of defective intervention. Below I summarize the theses of two of the leading studies on some of the apparent intervention effects in this language, before presenting the alternative.

4.6 Icelandic Raising Constructions⁴⁴

Let me initiate the discussion on Icelandic with some robust generalizations on agreement in quirky dative subject constructions (see Boeckx 1998, 2000; Boeckx 2003, Holmberg and Hroarsdottir 2003; Thrainsson 1979; Sigurdsson 1996 among others) with verbal agreement triggered by nominative objects. This is illustrated in (89), with the nominative DP *computers* triggering phi-agreement with the verb *find*. Sentence (90) shows that phi-agreement with the nominative is optional. Moreover, nominative objects are restricted to quirky dative subject constructions, as (89) and (90) show. They are absent from nominative subject constructions like (91).^{45,46}

(89) Mer finnst tolvurnar ljotar.

Me-dat. find-pl. the computers-nom. ugly-nom.

‘I find the computers ugly’

(90) Mer finnst tolvurnar ljotar.

Me-dat. find.sg. the computers-nom. ugly-nom.

‘I find the computers ugly’

(91) Vid kusum *hun/hana.

We-nom. elected *she-nom/her.acc.

‘We elected her’

⁴⁴ Unless specially mentioned, all Icelandic examples cited here are borrowed from Holmberg and Hroarsdottir (2003).

⁴⁵ Quirky dative subjects behave like nominative subjects with respect to various syntactic tests (see Zaenen, Maling and Thrainsson 1985 for a fuller exposition).

⁴⁶ Extensive discussion on Icelandic agreement is also found in Sigurdsson (1992, 1996, 2000, 2002); Taraldsen (1995); Schutze (1997); Boeckx (1998, 2000), Chomsky (2000); Hiraiwa (2001a,b); Haeberli (2002); Anagnostopoulou (2003); Bejar and Rezac (2003) and Koopman (2005) among others.

Also observe that only number agreement is morphologically manifested in sentences (89) and (90). Such agreement is out with first and second person pronominal objects that supposedly require overt person morphology. An unacceptable sentence with overt number morphology triggered by such pronominals is given in (92).⁴⁷

(92) *Henni leiddumst vid.

Her-dat. bored.1pl. us.nom.

‘They were bored with us’

Further, quirky datives never trigger verbal agreement. In the absence of a nominative object, the verb instead ends up taking a default value (third person, singular agreement), as shown in (93).

(93) Stelpunum var hjalpad.

The girls-dat.pl.fem. was.3sg. helped.sg.

‘The girls were helped’

Icelandic also allows cross-clausal agreement triggered by embedded nominative DPs in dative subject constructions like the following. A third person pronominal subject controls matrix verbal agreement in (94), while the dative experiencer moves to the

⁴⁷ According to Sigurdsson (1996), agreement between the verb and the nominative object is in most cases obligatory in monoclausal constructions.

specifier of TP. Cross-clausal agreement is not obligatory. The matrix verb may also bear default agreement morphology, as shown in (95).

(94) Mer virtust [paer vinna vel]
me-dat. seemed.3pl. they-nom. work well
'They seemed to me to work well'

(95) Mer virtist [paer vinna vel]
me-dat. seemed.def. they-nom. work well
'They seemed to me to work well'

Here too, the verb surfaces with only number morphology. First and second person pronominal DPs once again cannot trigger number agreement, as is shown by the unacceptable (96). The verb must instead bear default morphology (97).

(96) *Peim hofum alltaf fundist vid vinna vel.
Them-dat. have.1pl. always found we.nom. work well
'They have always thought that we worked well'

(97) Peim hefur alltaf fundist vid vinna vel
They-dat. have.3sg. always found we.nom. work well.
'They have always thought that we worked well'

There are certain constraints on cross-clausal agreement. For instance, it cannot obtain across embedded dative subjects (98). It is also absent in existential constructions (99)

with the dative experiencer lying in the path between the nominative and a matrix checking head. It is also out when the dative experiencer has A-bar moved, whether as a wh-phrase (100)-(101), a topic (102) or as in a relative clause (103).

(98) Mer fannst/*fundust [henni leidast peir]

Me-dat. seemed.3sg./*3pl. her-dat. bore they-nom.

‘I thought she was bored with them’

(99) Það virðist/*virðast einhverjum manni [hestarnir vera seinir].

It-expl. seem-sg/*seem-pl. some man-dat. the horses-nom. be slow-nom.

‘It seems a man finds the horses slow’

(100) Hvada student finnst/??finnast tolvurnar ljotar?

Which student.dat. find.sg/??find.pl. the computers.nom. ugly.nom.

‘Which student finds the computers ugly?’

(101) Hvada student veist þu að finnst/*finnast tolvurnar ljotar?

Which student.dat. know you that find.sg./*find.pl. the computers.nom. ugly.nom.

‘Which student do you know considers the computers ugly?’

(102) Þessum student veit ég að virðist/*virðast tolvurnar ljotar

this student.dat. know I that seem-pl. the computers.nom. ugly.nom.

‘I know that this student finds the computers ugly’

(103) Þetta er studentinn sem finnst/*finnast tolvurnar ljotar

this is the student.nom. that find-pl. the computers.nom. ugly.nom.

‘This is the student that finds the computers ugly’

It is important to note here that not all wh-phrases block cross-clausal nominative agreement. As opposed to (100)-(101), agreement is licit in interrogatives like (104)-(105).⁴⁸

(104) Hverjum hefur Olafur virst vera gafadur?

Who-dat. has Olaf-nom. seem-sg.be intelligent

‘Who has found Olaf intelligent?’

(105) Hverjum hafa hestarnir virst vera seinir.

Who-dat. have.3pl horses seemed be slow

‘To whom have the horses seemed to be slow’

In a nutshell, cross-clausal agreement triggered by embedded nominatives is possible only in quirky dative subject constructions and is overtly manifested only as number morphology. This, as is obvious, is very reminiscent of agreement triggered by nominative objects in mono-clausal constructions. One reasonable conclusion to draw from this similarity is that both relate to phi-agreement with the same head, possibly *v*. Quirky dative on the other hand is assigned against the functional head T/I. This last claim finds some support from sentences like (98) where the dative subject surfaces at the edge of the embedded clause, possibly in the specifier of embedded IP. Interestingly, as Boeckx (2003) points out, these nominals fail to A-move out of these positions. This is illustrated by the sentence in (106). Based on these examples, I assume that dative subjects move to the specifier of TP/IP for case, after which they are rendered inactive for

⁴⁸ Number agreement is obligatory in wh-constructions like (105).

case and phi-related computations. In this regard, Icelandic patterns very closely with English that also forbids A-movement out of case positions (107).

(106) *I dag hefur Joni virst [t var hjalpad].

Today has John-dat. seemed was helped.

‘Today, John seems like he was helped’

(107) *Today, John seemed [t was helped]

Having given a gist of the main characteristics of Icelandic cross-clausal agreement, let us turn to two of the main Agree-centered analyses that have so far been suggested for these structures. On one side is the analysis given by Holmberg and Hroarsdottir (2003), who try to explain the absence of Icelandic cross-clausal agreement by alluding to the notion of intervention. Under their approach, agreement triggers can enter into long-distance relations with matrix heads as long as there is no closer goal that is also a potential match for the probe. Interveners could be anything in the range of overt DPs or A-bar copies/traces. As long as these are present in the c-command path between the matrix probe and the embedded nominative, number agreement by the lower nominative must be ruled out. A slightly different approach is provided by Boeckx (2003). Like Holmberg and Hroarsdottir, Boeckx also adopts Agree to explain Icelandic agreement patterns but unlike them, he undermines the idea of defective intervention. In his view, absence of agreement results from the absence of the appropriate functional head that triggers agreement with the nominative. Nominative agreement is impossible in structures that lack the number triggering verbal head. Defective intervention becomes

largely superfluous in his theory. Below, I elaborate on each of these theories before showing their limitations.

4.6.1 Holmberg and Hroarsdottir (2003)

Holmberg and Hroarsdottir (2003) propose an Agree-based account for agreement in Icelandic raising constructions. In their understanding, cross-clausal agreement in sentences like (108) result from a long-distance relation between matrix T and the embedded nominative.

- (108) Mer virdast [hestarnir vera seínir]
 me-dat. seem.pl. the horses-nom. be slow.
 ‘It seems to me that the horses are slow’

Agree between these two items however takes place only after the matrix dative experiencer has targeted the specifier of TP for EPP. The implicit assumption is that T’s EPP feature is satisfied before T embarks on its search for a phi-checker. The derivation proceeds thus:

- (109)
- (i) [T [vP Dat [VP [IP Nom]]]]
 - (ii) [TP Dat T [vP Dat-t [VP [IP Nom]]]]
 - (iii) [TP Dat T [vP Dat-t [VP [IP Nom]]]]
- └──────────────────┘ ^

Once introduced into the derivation (i), T starts probing for an appropriate goal. It first encounters the dative, which is a potential goal for its EPP feature (ii). Once the dative has moved to the specifier of TP, the head embarks on its search again, this time encountering the nominative. This leads to phi-agreement between the two, resulting in overt number agreement that we actually witness on the verb in (108). Note that for their analysis to work, they must disallow A-traces/copies from inducing intervention. In other words, copies of A-moved elements must be invisible to the computational system in order not to be counted as potential goals for the probe.

As for existential constructions like the following (110), they argue that nominative agreement is impossible here because of the intervening dative experiencer. Since the specifier of matrix TP is occupied by an expletive, the dative must remain in-situ and thereby counts as a potential goal for T at the level of Match. Understandably, T fails to agree with the lower nominative (111). This is apparently a case of defective intervention as the dative itself is an inappropriate (i.e. defective) goal for the phi-set on T. However, its defective status does not undermine its ability as a potential intervener.

(110) Pad virdist/*virdast einhverjum manni [hestarnir vera seinir].

It-expl. seem-sg/*seem-pl. some man-dat. the horses-nom. be slow-nom.

‘It seems a man finds the horses slow’

(111) [TP expl. [T [vP dat. [TP...nom...]]]]

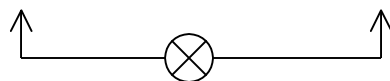

Similar arguments can be extended to constructions with intervening A-bar traces. These too apparently pose as potential goals for T at the level of Match, despite their defective nature. However for these specific cases, Holmberg and Hroarsdottir are forced to adopt a (revised) version of Svenonius’s (2001)⁴⁹ ‘Impatient Spell-Out’ that states that a category is spelt out only when it is ‘syntactically complete’ or once all of its “unspecified features” are valued.⁵⁰ A-bar elements hosted at the specifier of vP bear unchecked Q-features when T is introduced into the derivation. Given that they cannot be targeted by Spell-out at that derivational point, they are considered “phonologically empty”. T’s EPP feature must be satisfied by elements that have “phonological” content (a second crucial assumption in their work) and A-bar items at the specifier of vP do not fit the criterion. They nonetheless prevent T from seeking out the lower nominal. Consequently, T shows up with default value. The A-bar elements in turn move to the specifier of CP from the specifier of vP in one fell-swoop.⁵¹ The intervention scenario is captured in (112):⁵²

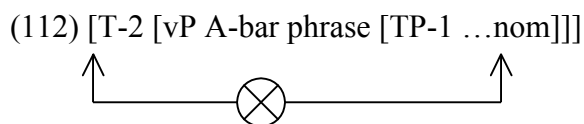

⁴⁹ This is a slightly modified version of Svenonius’s original conception of spell-out. The central premise of his paper is that certain sentential projections – akin to Chomsky’s (2000, 2001) strong phases - are spelled out immediately at the valuation of all (their) non-interpretible features. Holmberg and Hoarsdottir alter this proposal by suggesting that DPs – instead of phases – are spelt-out when fully checked.

⁵⁰ The term “unspecified features” is left undefined in Holmberg and Hroarsdottir’s paper. For present purposes, I assume it to be synonymous with “non-interpretible” or “unvalued” features.

⁵¹ The default value on T, they further argue, could be the overt manifestation of a case-value assigned to the head by C.

⁵² Topics and relative clause structures receive similar explanations. Dative nominals allegedly bear unchecked features and are not targeted by spell-out. This makes them ineligible goals for T’s EPP. Nominative agreement is once again interceded in their presence.

4.6.2 Boeckx (2003)

Boeckx (2003) also espouses Agree to explain Icelandic raising constructions though foreclosing the notion of defective intervention. Extending on the intuitions of Boeckx and Jeong (2003), he contends that intervention is direct. DPs must have unchecked features or case to be able to block phi-agreement. For him, dative case-marked DPs are computationally inactive and incapable of triggering phi-agreement on a probe. Therefore, the absence of nominative agreement cannot be blamed on intervention caused by the dative. Boeckx also makes a radical departure from standard theories by permitting nominative case-valuation against the functional head *v* (also see Harley 1999). A verbal head may (in very restricted contexts) optionally check nominative Case. In his understanding, there is a strong co-relation between nominative case checking by *v* and quirky/dative theta-role assignment: The head may check nominative only if it is also a quirky/dative theta-role assigner. Adopting the observations of previous studies (cf. Svenonius 2002; Eythorsson 2000) that quirky/dative DPs are mostly experiencers, goals or beneficiaries, Boeckx posits a (special) verbal head (*v*Q) that assigns experiential/goal/beneficiary theta-role to its external argument and values nominative to its internal argument. The full structure of *v*QP - with a dative external argument and a nominative object – is given in (113).

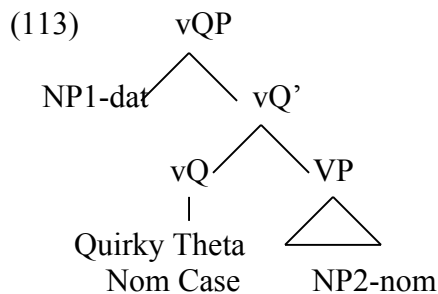

vQ differs from a nominative case-valuing T in disallowing person agreement. This explains why agreement with these nominatives is always restricted to number. To illustrate with a simple sentence like (114), for which Boeckx proposes the underlying representation in (115):

(114) Henni voru gefnar bakurnar

She-dat. were.pl. given.pl. books-nom.pl.

‘She was given the books’

(115) [TP [T [vQP dat [vQ nom]]]]

Quirky theta-role \uparrow \downarrow \uparrow Nominative Case

The dative argument or the derived subject starts off in the specifier of vQ where it receives a experiential theta-role and then ends up in the specifier of TP for case and EPP. The phi-features on vQ are then checked long-distance by the nominative object. A similar (though not identical) situation holds in the context of bi-clausal raising constructions. Take the raising construction in (116), with the main agreement steps illustrated in (117).

(116) Mer virdast [hestarnir vera seinir]

me-dat. seem.pl. the horses-nom. be slow

‘It seems to me that the horses are slow’

Note that at least in this particular case, we do not need to allude to defective intervention to explain the lack of nominative agreement. Since the structure lacks the appropriate vQ head to trigger verbal agreement, it is natural that it also fails to display nominative agreement. The ‘blocking scenario’ as Boeckx calls it, is also evident in a number of other cases, including expletive associate constructions, interrogatives and topic constructions. These sentences apparently involve an expletive occupying the specifier of TP. The expletive may be overt as in expletive associate constructions or covert as in sentences with wh-phrases, topics or relative clauses. Their common underlying representation is given in (119).

(119) [T ϕ expl. [vP dat. [IP...nom...]]]

The thrust of Boeckx’s proposal for these constructions is that expletives (both overt and covert) require a T ϕ , a tense head with independent agreement potential. T ϕ is incompatible with a nominative assigning vQ. These structures therefore lack the appropriate head to trigger nominative agreement, just as we observed above with examples like (118). It is therefore not surprising that the verb must show up with default agreement morphology in such cases.⁵⁴ The ‘blocking’ scenario however cannot accommodate structures like (120) where nominative agreement is insensitive to the presence of an A-bar element. If these structures also host a T ϕ , it is not immediately

⁵⁴ Boeckx reasons that the nominative may not instead agree with T because of “the presence of a quirky element, which either stays there [99: PC] or later undergoes A-bar movement [(100)-(103): PC]” (pp.31). Though he makes no explicit reference to the notion of defective intervention, the quote above raises doubt over the claim that Boeckx completely overhauls the notion from his system.

clear why number agreement is available to them, given that they too must lack the right vQ head to trigger agreement.

(120) Hverjum hafa/*hefur hestarnir virst vera seinir.

Who-dat. have.3pl/3sg. horses seemed be slow

‘To whom have the horses seemed to be slow’

To accommodate cases like these, Boeckx is then forced to propose a different, ‘movement scenario’ analysis. Under this approach, as in instances with nominative agreement, a vQ head enters into long-distance agreement with the embedded nominative. This is however followed by obligatory object shift, whereby the embedded nominative moves to the specifier of vQP for EPP reasons. Once object shift takes place, the dative nominal that is generated at the lower specifier of vQP cannot A-move over the shifted nominative. The only way that it can escape the vQP domain is via A-bar movement, as sketched in (121).⁵⁵

(121) [C [T [vP Nom-NP-i [vQP Quirky NP [vQ [VP [TP t-i [T...]]]]]]]]

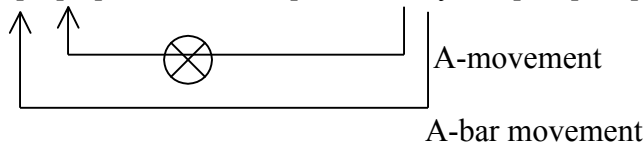

⁵⁵ This representation is taken from Boeckx’s (2003) paper. What is puzzling is the extra functional (vP) projection hosting the shifted object. Boeckx’s original tree diagram for dative-subject constructions (see 113) does not include a vP above vQP. Assuming this to be a printing error, if we were to posit the shifted nominative in the outer specifier of vQP, we must make the additional assumption that outer specifiers of the same head impede the movement for its lower specifiers. This would entail that the nominative in the outer specifier of vQP is placed structurally higher than the dative quirky hosted by vQ in its lower specifier.

There are two crucial assumptions underlying the ‘movement scenario’. First, the nominative DP undergoes object-shift to an A-position, which leads it to intercede A-movement for the dative. Second, datives A-move to the specifier of TP though they do not trigger actual valuation of T’s features. This requires Boeckx to claim that elements may simply match with the features of probes and move, without necessarily triggering agreement with them. Datives do not trigger agreement, but they bear a locative-like theta-role that matches the tense feature on T. This stimulates the dative to move to the specifier of TP. However as discussed above, once the nominative moves to a higher A-position, the dative will be forced to forsake its A-movement to TP and instead undergo A-bar movement to the C-domain.⁵⁶

4.6.3 Some Problems

A couple of problems with these accounts are discussed below. The first challenge that these Agree-based accounts face comes from structures like the following, taken from Taraldsen (1995).

(122) *Konunum-i fundust paer-i vera gafadar.

Women-the-dat. seemed.3pl. they-nom. be gifted-nom.fem.pl.

‘The women thought they were smart’

⁵⁶ It is unclear from Boeckx’s analysis how embedded nominative DPs ever target a main clause position for EPP reasons. Since such structures have intervening datives (base-generated in the main clause verbal domain), nominative movement (which is A-movement for him) must be accomplished in violation of Relativized Minimality.

(123) Konunum-i fannst paer-i vera gafadar.

Women-the-dat. seemed.3sg. they-nom. be gifted-nom.fem.pl.

‘The women thought they were smart’

The first sentence (122) with agreement is an instance of Condition B violation. The nominative case-marked pronominal subject of the embedded clause cannot be co-indexed with the matrix subject, indicating that they are clause-mates at some derivational point. On the other hand, sentences without agreement (123), allow co-reference between the two items, suggesting that the nominative in this instance is located in the lower clause. The binding differences in these two structures suggest that only agreement triggers move to the matrix clause and consequently fail to co-refer with the matrix subject. Non-agreeing nominatives on the other hand remain within the lower clause, which in turn allows them to take the matrix subject as a potential antecedent. In systems like the one proposed by Holmberg and Hroarsdottir, and Boeckx, this difference is hard to account for, since agreement works independently of movement. Agreeing nominals never move to the domain of the matrix clause checking head, just like their non-agreeing counterparts. Therefore the contrast in (122) and (123) is unexpected in their accounts.^{57,58}

⁵⁷ Anagnostopoulou (2003) – following an observation due to Halldor Sigurdsson – allows co-reference in (110). Assuming that these differences reflect dialectal variations, I claim that speakers allowing co-reference in (110) take the lower (reconstructed) copy of the nominative for binding purposes.

⁵⁸ Structures like (122) are reminiscent of English ECM sentences like (i), where co-reference between the matrix subject and the embedded argument is also ruled out. Assuming that ECM subjects move to the object position of the main clause (Lasnik (1998)), the ban on co-reference is expected.
(i) John-i believes him-j/*i to be a genius.

One way to avoid this problem is to posit an EPP feature on vQ, which would force all agreeing nominatives to obligatorily move to a main clause position. This feature however needs to be obligatory; vQ (or matrix v) must always possess this feature in order to attract the embedded nominative into its specifier. If embedded agreeing nominatives obligatorily move, it is easy to explain why as pronominals they must never take matrix dative subjects as their antecedents. That said, appealing to an obligatory EPP feature on vQ (or matrix v) raises other problems. As for instance, the resultant structure will always have the nominative targeting a position higher than the dative experiencer, which under Boeckx's view would suffice to block the latter's A-movement to the specifier of TP. Schematically:

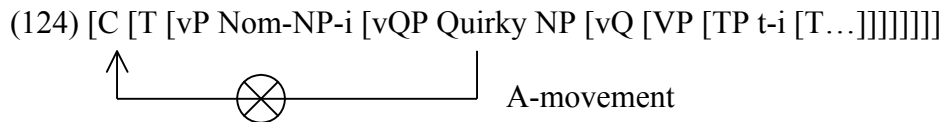

The problem with (124) is that it incorrectly rules out the following sentence (125), where the dative DP moves to the specifier of matrix TP. Since the agreeing nominative case-marked DP in this sentence must move to the specifier of vQ to satisfy vQ's EPP feature, it must (incorrectly) block the lower dative from A-moving over it.

- (125) Mer virdast [hestarnir vera seínir]
 me-dat. seem.pl. the horses-nom. be slow.
 'It seems to me that the horses are slow'

In summary, in this section, I have highlighted some problems with previous Agree-based accounts for optional Icelandic agreement. As we have seen, there are no straightforward answers available for them within these theories. With that, let us proceed to the next section, where I present a potential alternative for these facts.

4.6.4 A Different Approach to Icelandic Raising Constructions

The alternative proposal rests on two premises, neither one being particularly novel: (i) Icelandic nominative (on objects as well as embedded clause arguments) is valued against *v* and, (ii) Icelandic dative subjects are active with a quirky (inherent + structural) case. The first assumption, I borrow from Boeckx (2003) where nominative on objects is assumed to be assigned by *v*. Boeckx attributes a special *v*Q nominative checking head. However for my purposes, I will simply dub it (matrix) *v*. My second assumption is that dative case-marked DPs are active, i.e. they carry a quirky-structural case, eventually checked against I/T. This claim, as I have already mentioned is substantiated by the unacceptable Icelandic construction in (106), repeated as (126), which is taken to indicate that the dative subject, once it moves to the specifier of embedded TP/IP is given a case-value and consequently rendered inactive for clause-external case and phi-related computations.

(114) *I dag hefur Joni virst [t var hjalpad].

Today has John-dat. seemed was helped.

‘Today, John seems like he was helped’

Similar observations are also to be found in the works of Taraldson 1995, Sigurdsson 1996, 2000; Boeckx 2000 and Anagnostopoulou 2003 among others that contend that datives in general enter into case and phi-related computations with given heads. I make a slight modification here though and claim that datives check quirky case against a defective T (or I), which bears a person feature. Quirky case-valuation is dependent on person feature checking; therefore datives are active with only their person feature.⁵⁹

Before I proceed to the actual analysis, there is another (related) issue that demands our immediate attention: the Person Restriction in Icelandic. As mentioned in previous sections, nominative objects cannot trigger overt person agreement in quirky dative subject constructions. First and second person nominative case-marked pronominals are never found triggering main clause number agreement, as they require obligatory overt person agreement. The Person Restriction is apparently an enigma for my analysis since the first assumption that I make is that nominative case-valuing *v* has a full set of phi-features. As *v* has a person feature in its set of features, we expect it to manifest overt person morphology of the object it case-values, contrary to fact.

Anagnostopoulou (2003) provides a syntactic account for the Person Restriction. The thrust of her proposal is that datives check the person feature on T before it is accessed by the nominative for case. Consequently, T's person feature is never valued by the nominative, which explains why person morphology never gets reflected on the verb.

⁵⁹ This is not to say that Icelandic dative nominals do not possess complete phi-sets. They may carry non-defective phi-sets, but by virtue of being case-marked quirky in the language, they only use their person feature for phi-computations. In this regard, expletives and Icelandic datives seem to pattern alike; both receive case from a head in return of person-valuation. It is hard to gauge at this point if this is a universally attested feature. So I will simply stipulate it to be specific to Icelandic.

First and second person pronouns - unlike third person pronouns or “determiner pronouns” with only a number feature - have a person feature that must be checked against a head with the appropriate feature (also see Benveniste 1966; Postal 1966; Silverstein 1986; Bonet 1991; Taraldsen 1995; Ritter 1995; Kayne 1998 among others). These pronominals are therefore impossible in structures hosting Ts that are rendered person-less by the matrix clause dative at a prior derivational point. This analysis also allows Anagnostopoulou to draw a syntactic parallelism between the Person Restriction and Bonet’s (1991, 1994) Person-Case Constraint (127), discussed in reference to Greek, Georgian and Romance languages among others.

(127) Person-Case Constraint (PCC)

Context: Ditransitives with phonologically weak direct and indirect objects.

Observation: If a direct and an indirect object co-occur, the direct object has to be 3rd person.

PCC effects are illustrated in the following Greek examples (128)-(131).

(128) Tha mu to stilune.

Fut. cl-gen.1.sg. cl-acc.3sg.neut. send.3pl.

‘They will send it to me’

(129) Tha su ton stilune.

Fut cl.gen.2g. cl-acc.3sg.mas. send.3pl.

‘They will send him to you’

remains ill-defined till date. Bonet (1994) claims a universal status for the constraint. Thus we expect PCC effects to emerge in all languages. That this is not the case has already been argued in Ormazabal and Romero 2001; Haspelmath 2001, Ciucivara 2007 among others. Consider the following Romanian examples taken from Ciucivara (2007):

(132) I te au recomandat ieri
 3rd dat. 2nd acc. have.3rd. recommended yesterday.
 ‘They have recommended you to him yesterday’

(133) %I m - au recomandat ieri
 3rd dat. 1st acc. have.3rd. recommend yesterday
 ‘They have recommended me to him’

In (132)-(133), we find a second and first person accusative clitic co-appearing with a third person dative clitic. The acceptability of these Romanian sentences cannot be easily accounted for in a theory that takes the PCC as a universal constraint. More counter-evidence against a universal PCC is available in languages like Swiss German. Take the following examples from Anagnostopolou (2003) for illustration:

(134) D’ Maria zeigt en mir
 The Maria shows him to-me.
 ‘Mary shows him to me’

(135) D' Maria zeigt mir en

The Maria shows to-me him.

'Mary shows him to me'

(136) D' Maria zeigt mi em

The Mary shows me to him.

(137) *D' Maria zeigt em mich.

The Maria shows to-him me.

'Mary shows me to-him'

As illustrated above, Swiss German allots different structural positions for its third person and first/second accusative pronouns: while the former may either follow or precede dative clitics (134)-(135), the latter may only precede them (136)-(137). However, there is no restriction on the co-occurrence of first and second person pronouns with dative clitics. Based on these examples, I contend that the constraint cannot be given a universal status.⁶⁰

Also note that the PCC is specifically confined to clitic pairs. Similar effects are unavailable with clitic-full nominal pairs or full nominal pairs. Consider the Greek sentences given in (138) and (139), borrowed from Anagnostopoulou (2003). Sentence (138) contains a second person accusative DP and a genitive clitic, while (139) involves a first person accusative clitic co-occurring with a dative DP. Unlike what we previously observed with Greek clitics (see the sentences in (128)-(131)), these structures seem

⁶⁰ See Ciucivara (2007) for possible reasons for PCC effects in languages like French, Spanish etc.

goal. With current theoretical assumptions, the structural case on the lower goal must remain unvalued given that it enters into agreement with a defective head. This theoretical modification – of allowing phi-valuation to proceed in a piecemeal fashion – therefore must be avoided at present, especially as there is very little empirical justification for it.⁶¹

In light of these problems, it is hard to agree with Anagnostopoulou that dative experiencers in Icelandic raising constructions check off the person feature on the head that assigns nominative to the embedded argument. For present purposes, I instead opt for Boeckx's (2003) claim that overt agreement manifestation at the verbal domain – for reasons unclear to us at present – is minus person. This claim is widely substantiated cross-linguistically with languages rarely displaying person object agreement (with the exception of Basque). I will assume that the nominative case-valuing *v* has a full set of phi-features, which is checked against a lower nominal, but only part of the morphology is overtly manifested. Moreover, since *v* lacks overt person morphology, and first and second person pronominals have a specific requirement for it, they are typically absent from raising constructions. Needless to mention, the question of why overt person agreement morphology is absent on *v* is yet to be resolved. I leave it as an open question here.

⁶¹ The two cases that I know where phi-feature agreement is argued to proceed in a piecemeal fashion are the Basque ergative displacement constructions and Georgian agreement displacement sentences, discussed by Rezac (2003).

Let me begin the alternative analysis with structures like (140) where the dative subject appears in the specifier of TP while the embedded nominative triggers number agreement on the matrix predicate.

(140) Mer virdast [hestarnir vera seínir]

me-dat. seem.pl. the horses-nom. be slow

‘It seems to me that the horses are slow’

As per the assumptions in the previous section, the dative enters the derivation with an unvalued quirky case that keeps it active for phi-computations. Quirky datives are also like expletives in that they value the person feature on heads that they receive a case-value from. The derivation for (140), I assume, proceeds as follows:

(141)

(i) [VP Dat V [IP [vPNom...]]]

(ii) [v [VP Dat V [IP [vP Nom...]]]

(iii) [vP Dat. v [VP Dat V [IP [vP Nom...]]]]

(iv) [vP Nom [v' Dat.v [VP Dat V [IP [vP Nom...]]]]]

(v) [T [vP Nom [v' Dat.v [VP Dat V [IP [vP Nom...]]]]]]]

(vi) [TP DatT [vP Nom [v' Dat.v [VP Dat V [IP [vP Nom...]]]]]]]

As shown in (141), the derivation is built till matrix VP (i), with the dative and nominative case-marked nominals occupying the specifiers of matrix VP and embedded

vP respectively. Next we introduce matrix v (with a complete set of phi-features) as in (ii). The dative – being the closest active nominal – moves to its specifier in (iii). Note that this is an instance of A-movement, motivated for potential phi and case-checking with matrix v. However, the dative - being only person-active - fails to check the phi-set on v, in accord with Chomsky's (2001a) formulation (142).

(142) Maximize matching effects.

By (142), the grammar prefers to value all features within a given set simultaneously rather than getting them checked separately. That is, feature valuation takes place all at once rather than in a piece-meal fashion. This entails that the matrix verbal head in (140) does not agree with the person feature on the dative, even when it targets v's specifier by virtue of being the closest DP to it. Notice that once the dative targets the specifier of vP, the lower (nominative) DP becomes the closest goal to the head. This is of course under the assumption that copies do not count for Minimality.⁶² The copy left behind by the moved dative cannot be considered again for narrow syntactic computations. The nominative then targets the second (or outer) specifier of vP as shown in (iv), agreeing with v's complete phi-set in a local, sisterhood relation and in return receiving a nominative value for its structural case. The next step (v) is where matrix T is introduced. The dative finally moves to its specifier, checking off the non-interpretable person feature on T and in turn receiving a quirky dative value. This step of movement does not cause

⁶² Embedded T or I, I claim is defective and unable to check structural case.

any minimality violations as both nominals are placed in the minimal domain of vP, making them equidistant from a higher goal.^{63, 64}

Next I take up cases of apparent defective intervention, beginning with sentences like the following.

- (143) Mer fannst/*fundust [henni leidast peir]
 Me-dat. seemed.3sg./*3pl. her-dat. bore they-nom.
 ‘I thought she was bored with them’

(143) is out with cross-clausal agreement triggered by the embedded nominative. I claim that this is because the lower dative subject lies in the path between the matrix verb and the embedded object. Since the dative occupies the specifier of lower TP for quirky case reasons, the nominative object cannot move across it without causing minimality violations. It may however target an outer specifier of lower TP or adjoin to it to place itself in the same minimal domain as the embedded subject. Schematically (144):

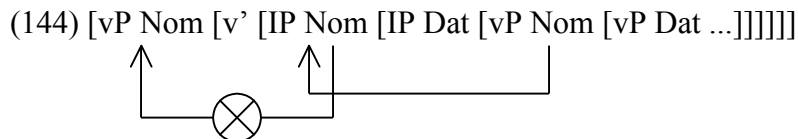

⁶³ When there is no cross-clausal agreement, I simply assume that the nominative receives a case in the downstairs clause and never moves to a main clause position.

⁶⁴ Given that Icelandic is a V-2 language, with overt verb raising to C in both matrix and embedded contexts, the matrix subject in (140) must be in the specifier of CP (I sidestep V-2 considerations in the embedded clause for the meantime). As for C, it must be occupied either by an overtly realized tense head (see below for an example) or the inflected lexical verb itself.

The problem, as also shown in the figure above is that once the nominative targets an A-bar position, it is forbidden from targeting a higher A-position by the ban on Improper Movement. Since the nominative fails to move to the domain of matrix vP, it is expected that it cannot agree with the head in phi-features. Notice that so far, I have implicitly assumed (144) to involve an embedded, defective v that is unable to assign structural case to the downstairs nominative. If on the other hand, embedded v turns out as non-defective, there is an additional reason for why nominatives fail to trigger number agreement in such instances. Since it is already case-checked internal to the embedded clause, there is no motivation for A-moving it to a higher clause position. The nominative is inactive for future phi-computations and expectantly, cannot trigger phi-agreement on a matrix head. Both analyses work perfectly fine for the present situation. I will therefore refrain from committing myself to any one approach for the meantime.

Next are the expletive-associate constructions like (145) where once again, nominative triggered number agreement is impossible on the matrix verb across an intervening dative experiencer.

- (145) Pad virdist/*virdast einhverjum manni hestarnir vera seinir.
 It-expl. seem-sg/*seem-pl. some man-dat. the horses-nom. be slow-nom.
 ‘It seems a man finds the horses slow’

My analysis for expletive associate constructions with dative subjects (145) is largely based on Hornstein and Witkos’ ruminations about expletive-associate constructions (that

I have already discussed at length in one of the previous sections). Without further ado, let us assume that expletives base-generate as adjoined to their associates in Icelandic too, as represented below in (146).

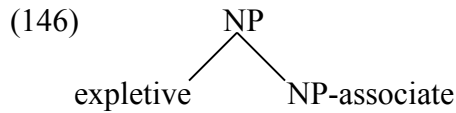

The relevant steps leading to (145) are then given below in (147). The NP complex comprising the expletive and its associate I assume, is base-generated inside matrix VP (see 147(i)).

(147)

(i) [VP NP expl-men] [VP nom ...]

(ii) [vP [NP expl-men] [VP [NP expl-men] [vP nom...]]]

(iii) [vP nom [v' NP expl-men] [VP [NP expl-men] [vP nom...]]]

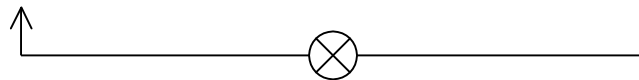

(iv) [TP expl T [vP [NP expl-men] [VP [NP expl-men] [vP nom...]]]]



In (ii), the complex NP moves to the specifier of vP for case and phi-feature checking. I assume that the associate has a full set of phi-features and an unvalued case. Therefore once it moves to the domain of v, it checks off the phi-set on the head. The important thing to note here is that once this happens, there is no way that the embedded nominative

can target the specifier of the same head for case and phi-valuation (iii). Since v's phi-set has already been checked, the head is incapable of assigning another case-value to the nominative. The embedded argument cannot fulfill its case-requirement in the matrix clause; it remains in situ and receives a default nominative. Finally, the expletive, which has its own case requirements targets the specifier of TP. This is shown in (iv).

There is a second solution to the problem. Consider the steps in (148) in this regard.

(148)

(i) [VP NP expl-men] [VP nom ...]

(ii) [vP [expl] [VP [NP expl-men] [vP nom...]]]

(iii) [vP nom [v' expl] [VP [NP men] [vP nom...]]]

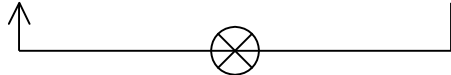

(iv) [TP expl T [vP [expl] [VP [NP expl-men] [vP nom...]]]]



The first step in 148 is similar to 147 (i). The associate-expletive complex base-generates inside the VP. However, instead of the whole NP moving, it is the expletive that targets the specifier of vP in (ii). However since it has only a person feature, it fails to check the complete phi-set on v. The reason why the embedded nominative cannot target the specifier of vP is because of the intervening NP-associate which is closer to v than the lower argument (iii). In order to move across it without causing minimality violations, the nominative DP must target a VP-adjoined position. However since this position counts as

an A-bar site, the argument is disallowed from targeting an A-position in the vP-domain by the ban on Improper Movement. The matrix verb is thus forced to take default values for its phi-set, while the expletive continues its journey to the specifier of TP, as in (iv).

That leaves us with the following contrast. In (149), the embedded nominative agrees with a main clause head despite the presence of a clause-mate wh-phrase. Sentences (150) to (152) on the other hand show that it is not always possible to trigger cross-clausal agreement in the presence of A-bar elements (or more precisely, intervening A-bar copies/traces).

(149) Hverjum hafa hestarnir virst vera seinir.

Who-dat. have.3pl. horses seemed be slow

‘To whom have the horses seemed to be slow’

(150) Hvada student finnst/??finnast tolvurnar ljotar?

Which student.dat. find.sg/??find.pl. the computers.nom. ugly.nom.

‘Which student finds the computers ugly?’

(151) Þessum student veit ég að virdist/*virdast tolvurnar ljotar

this student.dat. know I that seem-sg./*seem-pl. the computers.nom. ugly.nom.

‘I know that this student finds the computers ugly’

(152) Þetta er studentinn sem finnst/*finnast tolvurnar ljotar

this is the student.nom. that find-sg/*find-pl. the computers.nom. ugly.nom.

‘This is the student that finds the computers ugly’

Let me begin by detailing on (149) that might provide some clues to the agreement discrepancy observed above. First, the agreement trigger is placed before the matrix predicate *seem*. In other words, the lexical verb has not moved to C, via v and T, as we find in previous examples like (140), where *seem* not only carries the agreement morphology, but also precedes the agreement trigger. Second, the (number) agreement morphology is carried by an overtly realized T *have* that moves to C. In sentences (150) and (151) on the other hand, the verb *seem* carries the agreement morphology. Since these sentences are bad, let us tentatively contend that embedded DPs cannot check case against v in interrogatives or other sentences with A-bar moving elements. One reason for this could be that copies of wh-phrases and other A-bar items must be case-marked structurally inside the vP. Since the specifier of vP is already occupied by these items, it follows that that position is unavailable for embedded nominative DPs, which must then target the specifier of TP for case-checking. However, T must be overt in order to be able to assign case to these nominals. In instances where T is not overt, the nominative is forced to remain inside the embedded clause with a default case-value. Before I provide the details of the derivation, I must also note that (152) is out for a completely different reason. The matrix subject in this sentence is case-checked nominative and as I mentioned before, the type of agreement we are mainly concerned with here is possible only in quirky-dative subject constructions. The presence of a nominative subject correlates with obligatory subject-T agreement. It is therefore unsurprising that we do not find an embedded nominative triggering cross-clausal agreement in (152).

To come back to (149), I suggest that it is derived thus:

(153)

(i) [VP wh-Dat V [IP [...Nom...]]]

(ii) [v [VP wh-Dat V [IP [... Nom...]]]]

(iii) [vP wh-Dat [v [VP wh-Dat V [IP [... Nom...]]]]]

(iv) [T [vP [v [VP wh-Dat V [IP [... Nom...]]]]]]

(v) [TP Nom [wh-Dat [v [vP [v [VP wh-Dat V [IP [... Nom...]]]]]]]]

(vi) [CP wh-Dat [C+T [TP Nom [wh-Dat [T [vP [v [VP wh-Dat V [IP [...Nom...]]]]]]]]]]

The wh-phrase is base-generated within the VP, as shown in 153 (i). I will assume that it requires a structural case, which also implies that it bears a complete set of phi-features to value the features on a non-defective head. Next, a non-defective v is introduced into the derivation (ii). In (iii), the wh-phrase targets it and agrees with it in return for a structural case-value. In (iv), T is introduced into the workspace after which in (v), the wh-phrase targets the specifier of TP. Once it targets the specifier of TP, the nominative can move to a second specifier of TP and agree with it. The wh-phrase continues on its journey to the specifier of CP, as shown in (vi), while T moves and adjoins to the C head.

To the extent that this analysis is right, it predicts that the embedded nominatives can never move to the specifier of vP to agree with it. If it does, the A-bar item cannot be structurally case-marked inside vP, which I assume is a requirement in the language.

Schematically (154):⁶⁵

⁶⁵ For this particular case, I overlook the fact that the nominative DP's movement over the intervening wh-phrase is in violation of minimality.

(154) [vP Nom [v [VP wh-Dat V [IP [... Nom...]]]]]
 ↓
 unvalued case!

Moving the nominative DP to the specifier of vP in (154) results in case-checking for it. But this also crucially means that the wh-phrase will remain unchecked for case inside the vP, and hence will fail to satisfy the case requirement alluded to above. In addition, if the structure does not involve an overt, case-checking (matrix) T, the case of the raised nominative DP will remain unchecked in the main clause. Under these circumstances, when (i) there is an A-bar phrase in the main clause and (ii) there is no overt T to license case, the embedded argument will remain in situ, receiving a default case value from an embedded head. This is what we find in (150) and (151).

4.7 Conclusion

To conclude, in this chapter, I have reconfirmed my claim that agreement is always obtained in local configurations. DPs must move to the specifiers of respective heads in order to trigger agreement with them. In addition, I have also shown that notions like defective intervention cannot be maintained as a locality principle governing agreement. Rather locality in agreement must follow from the general economy principle Shortest Dependency and other constraints on movement.

CHAPTER 5

CONCLUSION: THE WAY FORWARD

5. 1 Summary of the results

I began this dissertation with the following questions. First, what (if any) are the conceptual motivations for positing a separate long distance transformation like Agree for phi-agreement? Second, is the empirical base for Agree strong enough to warrant its existence? I attempted to answer the first question in the introductory chapter, where I tried to trace any conceptual reason that may exist in defense of each of the three core operations in the grammar: Merge, Move and Agree. This chapter ended with the conclusion that unlike Merge and Move, conceptual arguments for Agree are few and rather weak. A core transformation based on asymmetric c-command, which is itself not a primitive of the grammar but derived from Merge and Move, firstly cannot be a grammatical primitive. Second, asymmetric c-command does not appear as the most optimal and economical way to phi-agreement in natural language. Search into the complement domain is not less or more computationally efficient than upward search by a DP active with structural case. If there are no strong conceptual arguments for Agree, it is necessary that we reevaluate its utility in the grammar and if possible, eliminate it from the system. Attempt must also be made to find explanations for phi-agreement in the two core grammatical operations: Merge and Move. The optimal theoretical option is to have local agreement between a functional head and a DP either merged or moved to its domain.

Matters are however less straightforward in the empirical domain, where there are ample cases of non-local agreement. The most convincing evidence for Agree comes from long-distance agreement constructions where agreeing heads and DP-triggers do not (necessarily) surface close to each other. This discrepancy between the theoretical and empirical domain raises an obvious concern. Does natural language then choose a less optimal solution for phi-agreement? Is Agree incorporated into the language faculty despite being economically and computationally least efficient? Undoubtedly, if the answers to these questions turn out to be in the affirmative, they prove Chomsky's (2000) Strong Minimalist Thesis wrong. The faculty of language is not an optimal solution to legibility conditions and it chooses operations that are not computationally efficient. Fortunately for us, the results of chapters 2, 3 and 4 give quite an opposite picture. The Strong Minimalist Thesis is thus left unhindered.

In chapters 2, 3 and 4, I take up particular instances of long-distance agreement and some other apparent cases of agreement via-Agree. In each of these chapters, I demonstrate the problems with Agree-centered approaches and then present possible movement alternatives.

Chapter 2 deals with agreement across restructuring infinitivals in Hindi-Urdu, Chamorro, Kashmiri and Itelmen. I revisit two prevalent analyses that have been proposed for these structures: Multiple Agree and AGREE. Both approaches assume that agreement triggers never leave their base-generated positions in the embedded clause. I

show that both analyses face serious problems, including their inability to explain the agreement-scope correlation. Appealing to QR to explain wide scope readings associated with agreeing DPs also does not suffice and often results in over-generation. I then go on to present an alternative movement analysis where agreement is established between a DP and a functional head after the former moves to the domain of the latter. The alternative analysis nicely captures the scope-agreement correlation without appealing to covert transformations like QR; wide scope is restricted to agreeing DPs because they overtly move and c-command the matrix volitional predicates with which they also enter into phi-agreement. My analysis is also compatible with a single-cycle syntax view that seeks to eliminate the covert cycle of transformations (see Chomsky 2001a, 2001b; Bobaljik 2002; Groat and O’Neil 1996, Pesetsky 1998). If scope can be derived via overt movement (and consideration of lower copies at LF), then covert transformations like QR need no longer be alluded to.¹

In chapter 3, I discuss agreement across finite boundaries in Tsez, Innu-aimun, Chukchee, Passamaquoddy, Hungarian and Basque. Previous studies are generally unanimous on the following points: (i) that these structures are derived by long distance Agree and, (ii) on the assumption that finite clauses have legitimate case-checkers, their DP-triggers are case-marked internal to the lower clause and yet remain active for clause-external phi-computations (therefore the Activation Condition loses its significance in the grammar). I show how these approaches are problematic, and suggest alternative analysis for them based on sideward movement. Sideward movement allows a nominal in a finite clause to

¹ See Pesetsky (2000) for non-LF related alternatives for Antecedent-Contained-Deletion (ACD) structures. These cases, along with scope, constitute some of the strongest motivation for a second, covert cycle of transformations.

target the theta-domain of a lexical verb in a different derivational workspace. Once the nominal starts its journey in the next tree, it is endowed with a second structural case, which it checks on *v*, in the process assigning the head with its own phi-values.

In chapter 4, I revisit some blocking effects on agreement in Japanese ditransitives and Icelandic raising constructions, allegedly caused by intervening, inactive or phi-incomplete heads. I argue that contra previous studies that explain them as intervention in long distance agreement, these blocking effects follow naturally from existing constraints on movement.

To summarize the results, there are alternative ways of explaining long distance agreement cases without appealing to Agree. The conflict between the conceptual/theoretical domain and the empirical domain is actually false. Rather, movement alternatives not only exist, but they are also more adequate in that they capture the full range of long-distance agreement structures. Moreover, they deal better with the semantics of agreeing DPs (these always get a special semantics like wide scope, topic, focus). Agree-centered analyses either totally undermine this aspect or allude to covert transformations that are themselves not very well motivated (as for instance, Bhatt's QR transformation, largely based on Fox's theory of Scope Shifting Operations). Under the alternative approach, semantics directly correlates (in most cases) with the landing site of the DP. In ambiguous instances on the other hand (as for instance, optional narrow scope for Hindi-Urdu LDA objects), the system resorts to LF reconstruction (or consideration of the lower copy) for interpretation.

In summary, if Agree is not the answer to phi-agreement in natural language, and if agreement is to take place in local, sisterhood configurations, then these are the mechanisms that are crucial to the system:

- (i) Reprojection, whereby nodes in the derivation can be accessed from different vantage points,
- (ii) Side-sideward, whereby items can move from one tree to another (parallel) tree,
- (iii) Movement of DPs to theta-positions.

All of these mechanisms have already been proposed in the literature and my study can be taken as another empirical justification for them. Nonetheless, a more thorough investigation of each of them is called for, along with the constraints that the system imposes on them. I leave this agenda open for future research.

5. 2 Some Remaining Issues

In this section, I take up some more cases of agreement that are at least *prima facie* evidence for Agree and mention the challenges they present for a theory without Agree. However, I do not attempt at any full-fledged explanation for them, though some tentative solutions are mentioned in the course of the discussion. This section therefore should be taken more as an exercise in finding problematic, unexplored domains of research that will eventually need to be addressed.

5.2.1 Agreement Asymmetry

The first challenge comes from the following Standard Arabic examples (borrowed from Soltan 2004), where the subject occupies two different positions and control two different types of verbal agreement: full (person, number and gender) agreement and partial (only gender) agreement.

(1) ?al-?awlad-u qara?-u/*qara?a d-dars-a
the boys-nom. read.3pl.mas./*3sg.mas. the lesson-acc.

‘The boys read the lesson’

(2) qara?a/*qara?-u l-?awlad-u d-dars-a
read-3sg.mas./3pl.mas. the boys-nom. the lesson-acc.

‘Boys read the lesson’

(3) ?al-fatayat-u qara?-na d-dars-a.
the girls-nom. read-3pl.fem. the lesson-acc.

‘The girls read the lesson’

(4) qara?a-t al-fatayat-u d-dars-a
read-3sg.fem. the girls-nom. the lesson-acc.

‘Girls read the lesson’

(1) is an SVO sentence, with full agreement triggered by the pre-verbal subject. Partial agreement is impossible with an SVO order. (2) on the other hand displays partial agreement with a post-verbal subject in an VSO ordered sentence; full agreement is not

an option here. Sentences (3) and (4) illustrate gender alterations with feminine pre and post-verbal subjects.²

Soltan (2004) provides an Agree-centered analysis that I summarize below. He starts off by noting two specific facts about the language that are crucial for his analysis. First, the said agreement shift is absent when the subject is a pronominal (5)-(6). Full verbal agreement is necessary irrespective of the pre-verbal or post-verbal status of the pronominal subject.

(5) (hum) qara?-u d-dars-a

they read.3pl.mas. the lesson-acc.

‘They have read the lesson’

(6) qara?a (hum-u) d-dars-a

read.3pl.mas. they-ev. the lesson-acc.³

Second, there is a clear semantic difference between pre-verbal and post-verbal subjects. Only the former get a specific/definite interpretation. They pattern closely with left dislocated DPs that are obligatorily definite/specific (see 7). Post-verbal subjects receivethetic interpretations just like other non-specific DPs that cannot be left dislocated, as illustrated by (8) and (9).

² Agreement asymmetry is absent from related languages like Lebanese Arabic and Moroccan Arabic (see Aoun, Benmamoun and Sportiche 1994).

³ EV stands for epenthetic vowel here.

(7) ?al-kitab-u/*kitab-un qara?a-hu Zayd-un
the book-nom./*book-nom. read-3sg.mas.it Zayd-nom.

‘Zayd read the book/*book’

(8) *walad-un kasara l-bab-a
boy-nom. broke-3sg.mas. the door-acc.

‘Boy broke the door’

(9) ?al-kitab-u/*kitab-un qara?a-hu Zayd-un
the book-nom./*book-nom. read-3sg.mas.it Zayd-nom.

‘Zayd read the book/*book’

Soltan explains the first case (obligatory full agreement by pro-subjects) by appealing to ‘Pro Identification Requirement’ (cf. Rizzi 1982; McCloskey 1986), that dictates that a null element *pro* must be identified at PF. Pro can be identified only by full agreement; therefore its structural position fails to determine the nature of overt verbal morphology that goes with it. The second property (i.e. the correlation that exists between clitic-left dislocated structures and subjects in SVO sentences), according to Soltan, suggests that pre-verbal subjects are base-generated as left dislocated DPs in the TP/CP domain. According to him, full agreement in SVO structures is not with the actual DP-subject, but with a *pro* in the specifier of vP (more below).

Soltan’s representations for structures with pre-verbal and post-verbal subjects are given in (10)-(11) respectively.

(10) [TP DP T+[v*+V] [v*P pro t-v* [VP t-V YP]]]

(11) [TP T+[v*+V] [v*P DP t-v* [VP t-V YP]]]

His central thesis is that T agrees long-distance with either a pro-subject (10) or with a DP as in (11), both placed in the vP domain. However only in the former is full agreement rendered obligatory (by the Pro Identification Requirement). In this case, what appears as the pre-verbal subject is actually a left-dislocated DP placed in the specifier of TP for EPP reasons. In the second case too, T agrees long-distance with the subject, but since it is not a pro-subject, nothing forces the overt manifestation of verbal agreement. Crucially, in the second case, T does not come equipped with an EPP feature. If EPP is the requirement to have a specifier (see Chomsky 1986a), then the subject must always end up in the TP domain, contrary to fact. In Soltan's analysis, EPP is optionally present on T.

The question to ask at this point is if the Standard Arabic cases discussed above are strong evidence for Agree. Or in other words, is a local agreement account absolutely impossible for these cases? A definite answer is impossible in this tentative note, but here is a speculative but Agree-free solution. Suppose Standard Arabic is one of these languages (just like Icelandic, see chapter 4) that allow agreement either at the vP or the TP level. Assume that it is also one of those languages where agreement at the vP level does not morphologically manifest person agreement (though other languages might, as for instance, Basque, Lebanese and Moroccan Arabic) unless forced to. The presence of pronominal subjects for instance, (for reasons unclear at this moment) forces overt

manifestation of the entire phi-set on *v*. In all other cases, all phi-values on *v* need not be phonologically realized. Given these two assumptions, we then have the two possible representations in (12) and (13) for SV and VS structures respectively.

(12) [TP DP-subject T+[*v**+V] [*v**P DP-subject *t*-*v** [VP *t*-V YP]]]

(13) [TP T+[*v**+V] [*v**P DP-subject *t*-*v** [VP *t*-V YP]]]

In (12), the DP subject first base-generates in the specifier of *v*P and then moves to the specifier of its case checker T. In this position, it also checks off the phi-set on T, whose values are all overtly manifested. T's EPP is also satisfied in the process. In (13) on the other hand, the DP-subject checks nominative case against *v** which overtly manifests the value of its gender feature. The object presumably remains in situ with a default accusative case. Functional head T, if it does carry an (obligatory) EPP, satisfies the requirement by verb-raising (see Alexiadou and Anagnostopoulou 1998).

5.2.2 Surface Semantics

Another potential problem for my analysis comes from prepositional small clauses in languages like European Portuguese. Consider the following example due to Raposo and Uriagereka (1990).

(14) Ontem em Beirute ficaram [SC os soldados sem armas]

yesterday in Beirut became the soldiers without guns

'The soldiers were without guns in Beirut yesterday'

Raposo and Uriagereka claim that the subject (*the soldiers*) of the prepositional small clause in (14) gets a nominative case from matrix T. Case assignment under their approach takes place long-distance without the DP moving to the specifier of TP. Though proposed in the Government and Binding (GB) framework, this analysis in essence is therefore very close to standard minimalist accounts that assume long-distance phi-feature and structural case checking (a.k.a. Agree). The most interesting fact about these structures is that there is a strict correlation between the surface position of the subject and its semantics. In instances where the subject appears in a post matrix-verbal position (as in (14)), it receives an obligatorythetic reading. In direct contrast are structures like (15), where the small clause subject surfaces in a pre matrix-verbal position and receives an obligatory categorical reading.

(15) Em Beirut, [esse soldados]-i ficaram ontem [SC t-i sem armas]

In Beirut those soldiers became yesterday without guns

This surface –semantic contrast (the one to one mapping between the surface position of a DP and its semantics) is difficult to capture in an alternative movement-based account. Given that the DP in (14) ends up with obligatorythetic reading, there is no evidence that it has moved out of the small clause at any point of the derivation. If it had moved to the specifier of TP for nominative case, a categorical reading (as evidenced in (15)) must in principle be available to it too, contra fact. Therefore it must be that the DP gets nominative from T long-distance.

A detailed investigation of these facts (needed to understand the phenomenon fully) is beyond the scope of this chapter. But I will nonetheless point out some independent evidence to show that these cases do not pose a real threat to the alternative theory developed in this thesis. Consider the following examples from Raposo (1989) in this regard.

(16) Eu vi-os-i [t-i a trabaha(r)em]

I saw-them prep working

‘I saw them working’

(17) Eu quero [os meninos a trabalharem ja]

I want the children prep. working now

‘I want the children to work now’

In Prepositional Infinitival Constructions, embedded subjects receive accusative case from the matrix verb only when they move out of the lower clause. This is shown in (16), where the pronominal subject must cliticize onto the main clause verb in order to get a case from it. In (17) on the other hand, the infinitival subject remains in situ. It is however case-marked nominative. Notice that this case cannot be assigned by matrix T whose case-assigning property can be used only for the matrix subject, which also receives a nominative case-value. Crucially then, nominative case on the embedded subject in this sentence must be default.

If true, then we can claim that in cases where the post matrix-verb DP gets a thetic interpretation (as in (14)), it actually ends up getting a default nominative case value inside the small clause itself. Since it never moves to a position outside the small clause, it is predicted that it receives an obligatory non-categorical interpretation unlike its counterpart in (15).

5.2.3. A Wh-in-situ Problem

There is a second domain where Agree is said to play a role: the domain of wh-interrogatives. This was left out of the present study, since our concentration was on A or phi-agreement. However there is one interesting Agree-related aspect of interrogatives that I must point out before ending the chapter. This concerns wh-in-situ languages. Consider the following examples from so called wh-in-situ languages Bangla (18) Hindi-Urdu (19), and Oriya (20) (also see Mahajan 1990; Dayal 1996 and Bayer 2000/2004 a.o.).

(18) John ki kinlo?

John what bought

‘What did John buy?’

(19) John kyaa kharida?

John what bought

(20) John kana kinila?

John what bought

In Government and Binding theory (cf. Chomsky 1981), movement is allowed at two levels: S-structure (SS) and Logical Form (LF). Under this approach, languages differ on whether their wh-phrases move overtly at SS (eg. wh-fronting languages like English, Bulgarian etc.) or undergo (obligatory) movement at LF (eg. wh-in-situ languages). In the current minimalist paradigm however, movement of the wh-phrase to the specifier of CP is no longer considered obligatory. Moreover covert feature checking as well as covert movement is totally substituted by Agree in overt syntax. It is argued that wh-phrases Agree long-distance with C in overt syntax in all languages (21). They then undergo obligatory movement in some languages, forced by some wh-feature on the C head.

(21) [C-Q feature [T [vP [VP wh-phrase-Q feature]]]]



In (21), the C head has a non-interpretable Q-feature that it checks against the interpretable Q-feature on the wh-phrase. Q-feature checking takes place long-distance without the wh-phrase undergoing overt movement to the specifier of CP. Wh-in-situ languages, where the wh-phrase appears in its in-situ (VP-internal) position apparently provide excellent examples for Agree in the domain of interrogatives. This is therefore yet another domain where Agree seems to play a critical role.

However there are some interesting facts about the wh-in-situ languages in question that have escaped the attention of previous researchers. On close inspection, wh-interrogatives

in these languages provide substantial evidence for overt wh- movement. The most convincing evidence for overt movement comes from their island-sensitive behavior.

(22) *John [e kothaa ki mary ki pochondo kore] jaane?

John this fact that Mary what like do know

‘*What does John know the fact that Mary likes?’

(23) *John [yeh baat ki Mary kyaa pasand karti he] jaantaa he?

John this fact that Mary what like do be know be

(24) *John janichi [Mary ra kana pasand bisayare]?

John knows Mary gen what like matter

A standard assumption in the literature is that only overt movement/Move is sensitive to islands (though see Mahajan 1990; Dayal 1994, 1996, 2003 for different views). Unlike Move, Agree is insensitive to islands (see Boskovic 2005, also discussed in chapter 3). We therefore do not expect Agree-driven wh-in-situ to be sensitive to islands, contrary to fact. Bangla, Hindi-Urdu and Oriya wh-in-situ are obvious exceptions; they must therefore involve overt wh-movement to the specifier of CP, with the decision to pronounce either the higher or the lower copies left to PF. Evidence for movement is also found in wh-scope marking constructions as well as multiple wh-questions (see Chandra in prep, Chandra and Malhotra 2006, 2007 for more elaborate discussions).

In light of this, I will claim that even in the A-bar domain, the relevance of Agree is less than clear. Languages that have traditionally been clubbed together under wh-in-situ

languages display signs of overt movement, which suggests that their wh-phrases cannot long-distance Agree with C. They must instead move to the specifier of C for Q-feature checking. Feature checking in this domain too takes place in local, sisterhood configurations.

However there are numerous questions that remain unresolved at this point, especially with regard to languages like Chinese, which fail to obey movement diagnostics and therefore remain as crucial evidence for Agree. These and various other questions, I hope to be able to take up more seriously in the future.

REFERENCES

- Abels, K. 2003. *Successive Cyclicity, Anti-Locality, and Adposition Stranding*. Doctoral dissertation. Storrs: University of Connecticut.
- Abney, S. 1987. *The English Noun Phrase in its Sentential Aspect*. Doctoral dissertation. Cambridge, MA: MIT.
- Aissen, J. and D. Perlmutter. 1976. Clause reduction in Spanish. In *Proceedings of the Second Annual Meeting of the Berkeley Linguistic Society (BLS 2)*, eds. Henry Thompson, Kenneth Whistler, Vicki Edge, Jeri Jaeger, Ronya Javkin, Miriam Petruck, Christopher Smeall, and Robert D. Van Valin Jr., 1-30. Berkeley: Berkeley Linguistic Society.
- Aissen, J., and D. Perlmutter. 1983. Clause reduction in Spanish. In *Studies in Relational Grammar 1*, ed. David Perlmutter, 360-403. Chicago: The University of Chicago Press.
- Alexiadou, A. and E. Anagnostopoulou. 1998. Parameterizing AGR: Word Order, V-movement and EPP-checking. *Natural Language and Linguistic Theory* 16:491-539.
- Anagnostopoulou, E. 2003. *The Syntax of Ditransitives: Evidence from Clitics*. Berlin & New York: Mouton deGruyter.
- Aoun, J., E. Benmamoun and D. Sportiche 1994. Agreement, word order and conjunction in some varieties of Arabic. *Linguistic Inquiry* 25:195-220.
- Aoun, J., L. Choueiri and N. Hornstein. 2001. Resumption, movement and derivational economy. *Linguistic Inquiry* 32:371– 403.
- Artiagoitia, X. 2002. The Functional Structure of the Basque Noun Phrase. In *Erramu Boneta: Festschrift for Rudolf P. G. de Rijk*, eds. X. Artiagoitia et al, 73-90. ASJUren Gehigarriak XLIV. Bilbao: EHU.
- Artiagoitia, X. 2004. Izen Sintagmaren birziklatzea: IS-tik izenaren inguruko funtzio buruetara. In, *Euskal gramatika XXI. mendearen atarian: arazo zaharrak, azterbide berriak*, eds. P. Albizu and B. Fernández. Diputación Foral de Álava
- Atkinson, M. 2001. Defective Intervention Effects, Die!. *Essex Research Reports in Linguistics* 37.
- Baker, M., K. Johnson and I. Roberts. 1989. Passive Arguments Raised. *Linguistic Inquiry* 20:219-251.
- Basilico, D. 1997 The topic is ‘there’. *Studia Linguistica* 51:278-316.

- Bayer, J. 2000/2004. Wh-in-situ . Ms. University of Konstanz.
- Bejar, S. and D. Massam. 1999. Multiple case checking. *Syntax* 2:2:65–79.
- Belletti, A. 1988. The case of unaccusatives. *Linguistic Inquiry* 19:1–34.
- Benveniste, E. 1966. Relationships of person in the verb. In *Problems in General Linguistics*, 195–204. Coral Gables, Florida: University of Miami Press. English translation by Mary Elizabeth Meek published in 1971.
- Bhatt, R. 2005. Long Distance Agreement in Hindi-Urdu. *Natural Language & Linguistic Theory* 23:757-807.
- Bhatt, R. 1993. Word Order and Case in Kashmiri. PhD dissertation. University of Illinois.
- Bhatt, R. 1994. Word Order, Configurationality and the Structure of the Kashmiri Clause. In *Theoretical Perspectives on Word Order in South Asian Languages*, eds. M. Butt, T. H. King and G. Ramchand, 31-66. Stanford: CSLI.
- Bittner, M. 1994. *Case, scope and binding*. Dordrecht: Kluwer.
- Bittner, M. and K. Hale. 1996a. The structural determination of case and agreement. *Linguistic Inquiry* 27.1:1-68.
- Bittner, M. and K. Hale. 1996b. Ergativity: towards a theory of a heterogeneous class. *Linguistic Inquiry* 27.4: 531-604
- Bobaljik, J. and S. Wurmbrand. 2003. Long distance object agreement, restructuring and anti-reconstruction. In *Proceedings of the North Eastern Linguistics Society Annual Meeting 33* (NELS 33), eds. Makoto Kadowaki and Shigeto Kawahara, 67-86. Amherst: GLSA, University of Massachusetts.
- Bobaljik, J. and S. Wurmbrand. 2005. The Domain of Agreement. *Natural Language and Linguistic Theory* 23:809-865.
- Bobaljik, J and K. Yatsushiro. 2004/2006. Problems with Honorification-As-Agreement in Japanese: A reply to Boeckx & Niinuma. *Natural Language and Linguistic Theory* 24:355-384
- Boeckx, C. 1998. Agreement Constraints in Icelandic and Elsewhere. *Working Papers in Scandinavian Syntax* 62:1-35.
- Boeckx, C. 2000. Quirky Agreement. 2000. *Studia Linguistica* 54:451-480.

- Boeckx, C. 2004. Long Distance Agreement in Hindi: Some Theoretical Implications. *Studia Linguistica* 58:23-36.
- Boeckx, C. 2006. Honorification as agreement. *Natural Language and Linguistic Theory* 24:385-398
- Boeckx, C and Y. Jeong. 2003. The fine structure of Intervention. MS. University of Maryland, College Park.
- Boeckx, C. and F. Niinuma. 2004. Conditions on agreement in Japanese, *Natural Language and Linguistic Theory* 22.3:453-480.
- Bonet, E. 1991. Morphology after syntax: Pronominal clitics in Romance. Doctoral dissertation. Cambridge, MA: MIT.
- Bonet, E. 1994. The Person-Case constraint: A morphological approach. In *The morphology-syntax connection*, eds. Harley, Heidi and Phillips, Colin (*MIT Working Papers in Linguistics* 22) 33-52. Cambridge: MIT.
- Borer, H. 1989. On the Morphological Parallelism between Compounds and Constructs. In *Morphology Yearbook 1*, eds. G. Booij and J. van Marle. Dordrecht: Foris.
- Boskovic, Z. 1997. *The Syntax of Nonfinite Complementation: An Economy Approach*. Cambridge, MA: The MIT Press
- Boskovic, Z. 2002. On multiple wh-fronting. *Linguistic Inquiry* 33.3:351-383
- Boskovic, Z. 2005. Agree, phases, and intervention effects. To appear in *Linguistic Analysis*.
- Bouchard, D. 1984. *On the Content of Empty Categories*, Dordrecht: Foris.
- Branigan, P. and M. MacKenzie. 2002. Altruism, A-movement, and object agreement in Innu-aimûn. *Linguistic Inquiry* 33:385-407.
- Bruening, B. 2001. *Syntax at the Edge: Cross-clausal Phenomena and the Syntax of Passamaquoddy*. Doctoral dissertation. Cambridge, MA: MIT.
- Bruening, B. 2006. Discrepancies between Projection and Selection: Split Coordination and Raising to Object in Passamaquoddy. Ms. University of Delaware.
- Butt, M. 1995. *The structure of complex predicates in Urdu*. Stanford, CA: CSLI.
- Butt, M. 1997. Aspectual Complex Predicates, Passives and Disposition/Ability. Talk held at the Linguistics Association of Great Britain, Spring Meeting, April. Extensive handout available at <http://ling.uni-konstanz.de/pages/home/butt>.

Cagri, I. 2004. The EPP of T in Turkish. In *University of Maryland Working Papers in Linguistics* 13:37-52.

Chametzky, R 2000. *Phrase structure: from GB to minimalism*. Malden: Blackwell.

Chandra, P. 2004. Hindi-Urdu Left Dislocation, Minimality and PF-movement. Ms. University of Maryland, College Park.

Chandra, P. 2006. Defective Intervention Effects: Comparing Hindi-Urdu with Tsez. Paper presented at The Chicago Linguistic Society. Chicago

Chandra, P. 2007. Long-Distance Agreement in Tsez: A Reappraisal. In *University of Maryland Working Papers in Linguistics 15*, ed. A. Conroy, C. Jing, C. Nakao and E. Takahashi, 47-72. College Park, MD: UMWPiL.

Chandra, P. in prep. Wh-in-situ and Single-cycle Syntax. Ms. University of Maryland, College Park.

Chandra, P. and S. Malhotra. 2006. Yet another approach on Wh-scope marking. Paper presented at the South Asian Languages Analysis 26. Kannada University, Mysore, India.

Chandra, P. and S. Malhotra. submitted. A short note on wh-scope marking. University of Maryland Working Papers in Linguistics 16.

Chierchia, G. 1983a. Outline of a semantic theory of (obligatory) control. In *Proceedings of the 2nd West Coast Conference on Formal Linguistics (WCCFL 2)*, M. Barlow, D.P. Flickinger and M. T. Wescoat (eds). Stanford, CA: Stanford Linguistics Association.

Chierchia, G. 1984a. Anaphoric Properties of infinitives and gerunds. In *Proceedings of the 3rd West Coast Conference on Formal Linguistics (WCCFL 3)*, Stanford, CA: Stanford Linguistics Association.

Chierchia, G. 1984b. Topics in the Syntax and Semantics of Infinitives and Gerunds. Doctoral dissertation. Amherst, MA: University of Massachusetts.

Chierchia, G. 1989. Structured Meanings, Thematic Roles and Control. In *Properties, Types and Meanings II*, eds. Gennaro Chierchia, Barbara Partee, and Raymond Turner, 131-166. Dordrecht: Kluwer.

Chierchia, G. 1990. Anaphora and Attitudes *De S*. In, *Semantics and Contextual Expression*, eds. Renate Bartsch, Johan van Benthem and Peter van Emde Boas, 1-32. Dordrecht: Foris.

Chomsky, N. 1957. *Syntactic Structures*. The Hague/Paris: Mouton

- Chomsky, N. 1980. *Rules and Representations*. New York: Columbia University Press.
- Chomsky, N. 1981. *Lectures on Government and Binding*. Dordrecht: Foris.
- Chomsky, N. 1986a. *Knowledge of Language*, Praeger.
- Chomsky, N. 1986b. *Barriers*. Cambridge, MA.: The MIT Press.
- Chomsky, N. 1991. Some Notes on the Economy of Derivation. In *Principles and Parameters in Comparative Grammar*, Robert Freidin, ed. Cambridge, MA: The MIT Press.
- Chomsky, N. 1993. A minimalist program for linguistic theory. In, *The View from Building 20: Essays in Linguistics in Honor of Sylvain Bromberger*, eds. Kenneth Hale and Samuel Jay Keyser, 1-52. Cambridge, MA: The MIT Press.
- Chomsky, N. 1994. Bare Phrase Structure. *MIT Occasional Papers in Linguistics 5*. Cambridge, MA: MITWPL
- Chomsky, N. 1995. *The Minimalist Program*. Cambridge, MA: The MIT Press.
- Chomsky, N. 2000. Minimalist inquiries: the framework. In *Step by step: essays on minimalist syntax in honor of Howard Lasnik*, eds. Roger Martin, David Michaels, and Juan Uriagereka, 89-155. Cambridge, Mass.: The MIT Press.
- Chomsky, N. 2001a. Derivation by phase. In *Ken Hale: A life in language*, ed. Michael Kenstowicz, 1–52. Cambridge, MA: The MIT Press.
- Chomsky, N. 2001b. Beyond Explanatory Adequacy. *MIT Occasional Papers in Linguistics 20*.
- Chomsky, N. 2005a. Three Factors in Language Design. *Linguistic Inquiry* 36:1-22.
- Chomsky, N. 2005b. On Phases. Ms. MIT, Cambridge, MA.
- Chomsky, N. 2006. Approaching UG from Below. Ms. MIT.
- Chomsky, N. and H. Lasnik. 1993. The theory of principles and parameters. In *Syntax: An International Handbook of Contemporary Research, Vol. 1*. eds. J. Jacobs et al., 506-569. Walter de Gruyter. (Reprinted in N. Chomsky, *The Minimalist Program*. The MIT Press, 1995)
- Chung, S. 1998. *The Design of Agreement: Evidence from Chamorro*. Chicago and London: The University of Chicago Press.
- Chung, S. 2004. Restructuring and Verb-Initial Order in Chamorro. *Syntax* 7: 199-233.

- Cinque, G. 1997a. The interaction of passive, causative, and 'restructuring' in Romance. Ms., University of Venice.
- Cinque, G. 1997b. Restructuring and the order of aspectual and root modal heads. Ms., University of Venice.
- Cinque, G. 2000. "Restructuring" and functional structure. Ms., University of Venice.
- Ciucivara, O.S. 2007. Challenging The Person Case Constraint: Evidence from Romanian. Paper presented at the Linguistic Society of America 2007, Anaheim.
- Clark, R. 1990. *Thematic Theory in Syntax and Interpretation*. London: Routledge.
- Collins, C. 2002. Eliminating Labels. In (eds.) *Derivation and Explanation in the Minimalist Program*, eds. Samuel Epstein and Daniel Seely, 42-64. Oxford: Blackwell Publishing.
- Corver, N. 1990. The syntax of left branch extractions. Doctoral dissertation, Tilburg University.
- Dahlstrom, A. 1995. Morphology and syntax of the Fox (Mesquakie) language. Ms. University of Chicago.
- Davison, A. 1988. Constituent structure and the realization of agreement features. In *Papers from the 24th Regional Meeting of the Chicago Linguistics Society*, eds. Macleod, Lynn et al. 41-55. Chicago: Chicago Linguistics Society.
- Davison, A. 2001. Ergative case licensing, agreement and reflexive binding. *Linguistic Structure and Language Dynamics in South Asia*. eds. A. Abbi, R.S. Gupta and A. Kidwai. Motilal Banarsidass. Delhi.
- Davison, A. 2004. Structural case, Lexical case and the verbal projection. In *Clause Structure in South Asian Languages*, eds. V. Dayal and A. Mahajan. Dordrecht: Kluwer.
- Dayal, V. 1994. Scope marking as Indirect WH -Dependency. *Natural Language Semantics* 2:2.
- Dayal, V. 1996. *Locality in Wh-quantification: Questions and Relative Clauses in Hindi*, Dordrecht: Kluwer
- Dayal, V. 2003. *Multiple WhQuestions*. SynCom# 66
- De Hoop, H. 1992. Case and Configurationality. Doctoral dissertation. University of Groningen.

- Dikken, M den. 2005. When Hungarians agree to (dis)agree: The fine art of ‘phi’ and ‘art’. Ms., CUNY Graduate Center [updated version, spring 2006].
- DiSciullo, A.M., and E. Williams. 1987. *On the definition of word*. Cambridge, MA: The MIT Press.
- Dowty, D. 1985. On Recent Analyses of the Semantics of Control. *Linguistics and Philosophy* 8:291–331.
- Enc, M. 1991. ‘The Semantics of Specificity’, *Linguistic Inquiry* 22:1-25.
- Epstein, S., E. M.Groat, R. Kawashima and H. Kitahara. 1998. *A Derivational Approach to Syntactic Relations*. Oxford University Press.
- Etxepare R. 2005. Long Distance Agreement in substandard Basque. *International Journal of Basque Language and Linguistics. In Honor of Larry Trask*
- Eythorsson, T. 2000. Dative vs. nominative: Changes in quirky subjects in Icelandic. In *Leeds Working Papers in Linguistics and Phonetics*. eds. D. Nelson and P. Foulkes. Department of Linguistics and Phonetics. University of Leeds: Leeds.
- Fanselow, G. 1989. Coherent infinitives in German. In *Syntactic phrase structure phenomena in noun phrases and sentences*, eds. Christa Bhatt, Elisabeth Löbel, and Claudia Schmidt, 1-16. Amsterdam: John Benjamins.
- Ferreira, F. 2000. Syntax in language production: An approach using tree-adjoining grammars. In *Aspects of Language Production*, ed. L. Wheeldon. Cambridge, MA: The MIT Press.
- Frank, R. 2005. Phase Theory and Tree Adjoining Grammar. Phase Theory and Tree Adjoining Grammar. Ms, Johns Hopkins University.
- Frank, R. and K. Vijay-Shanker. 1999. Primitive c-command. Ms. Johns Hopkins University and University of Delaware.
- Frank, R., P. Hagstrom, and K. Vijay-Shanker 2002. Roots, Constituents, and C-command. In *Theoretical Approaches to Universals*, ed. Artemis Alexiadou, 109-137. Amsterdam: John Benjamins.
- Franks, S. and J. E. Levine. 2004/2006. Case and word order in Lithuanian. *Journal of Linguistics* 42:239–288.
- Frantz, D.G. 1978. Copying from complements in Blackfoot. In *Linguistic studies of native Canada*, eds. Eung-Do Cook and Jonathan Kaye, 89-110. Vancouver: University of British Columbia.

- Fox, D. 2000. *Economy and Semantic Interpretation*, Linguistic Inquiry Monograph. Cambridge, MA: The MIT Press.
- Fox, D and J. Nissenbaum. 1999. Extraposition and Scope: A case for overt QR. *WCCFL 18*.
- Fujii, T. 2005. Cycle, Linearization of Chains, and Multiple Case Checking. *Proceedings of the CONSOLE XIII*.
- Gervain, J. 2003. Syntactic microvariation and methodology: Problems and Perspectives. *Acta Linguistica Hungarica* 50:405-434.
- Gervain, J. 2005. Two strategies of focus-raising: Movement and resumption. In *Approaches to Hungarian 9. Papers from the Dusseldorf Conference*. eds. C. Pinon and P. Siptar. Budapest: Akademiai Kiado.
- Grewendorf, G., and J. Sabel. 1994. Long scrambling and incorporation. *Linguistic Inquiry* 25:263-308.
- Grohmann, K.K. 2000. *Prolific peripheries: A radical view from the left*. Doctoral dissertation, University of Maryland, College Park.
- Grohmann, K.K. 2003. *Prolific domains: On the anti-locality of movement dependencies*. Amsterdam: John Benjamins.
- Haerberli, E. 2002. *Features, Categories and the syntax of A positions*. Kluwer. Dordrecht.
- Hankamer, J. 1973. Unacceptable ambiguity. *Linguistic Inquiry* 4.1.
- Harada, S. I. 1976. Honorifics. In *Syntax and semantics 5: Japanese generative grammar*, ed. Masayoshi Shibatani, 499–561. New York: Academic Press.
- Harley, H. 1999. Denominal verbs and aktionsart. In *Proceedings of the 2nd Penn/MIT Roundtable on Event Structure*, eds. L. Pyllanen and A. van Hout. MITWPL: Cambridge
- Haspelmath, M. 2001. Explaining the Ditransitive Person-Role Constraint: A usage-based approach. Ms. Max-Planck-Institut für evolutionäre Anthropologie.
- Hazout, I. 2004. Long-Distance Agreement and the Syntax of for-to Infinitives. *Linguistic Inquiry* 35:338-343
- Heycock, C. 1994. *Layers of Predication*. New York: Garland Publishing Co.
- Hiraiwa, K. 2001a. Multiple Agree and the defective intervention constraint. In *MITWPL #40*. Cambridge, MA.: MITWPL.

- Hiraiwa, K. 2001b. On nominative-genitive conversion. In *A few from Building E39*, eds. E. Guerzoni and O. Matushansky, MIT Working Papers in Linguistics 39, 65–123. Cambridge, MA: MITWPL.
- Hiraiwa, K. 2005. Dimensions of symmetry in syntax: agreement and clausal architecture. Doctoral dissertation. Cambridge, MA: MIT.
- Hoekstra, T. and R. Mulder. 1990. Unergatives as copular verbs: Locational and existential predication. *The Linguistic Review* 7:1-79.
- Holmberg, A. and T. Hroarsdottir. 2003. Agreement and Movement in Icelandic Raising Constructions. *Lingua* 113: 997-1019.
- Hong, S. 2005. "Exceptional" Case-Marking and Resultative Constructions. Doctoral dissertation. University of Maryland.
- Hornstein, N. 1999. Movement and control. *Linguistic Inquiry* 30: 69-96.
- Hornstein, N. 2001. *Move! A Minimalist Theory of Construal*. Cambridge: Blackwell.
- Hornstein, N. 2005. Deriving C-Command. Ms. University of Maryland
- Hornstein, N. and M. Motomura. 2002. Psych Verbs, Theta Roles and Reconstruction. In *Proceedings of 2002 LSK International Summer Conference*. Vol II, 39-58. Linguistics Society of Korea.
- Hornstein, N., J. Nunes, and P. Pietroski. 2005. Some thoughts on adjunction. Ms., UMD/USP.
- Hornstein, N. and J. Uriagereka. 2002. Reprojections. In *Derivation and Explanation in the Minimalist Program*. eds. S. Epstein and D. Seely. London: Blackwell, 106-132.
- Hornstein, N and J. Witkos. 2003. Yet another approach to existential constructions. Ms. University of Maryland, College Park.
- Huang, C.T. James. 1982. Logical relations in Chinese and the theory of grammar. Doctoral dissertation. Cambridge, MA: MIT.
- Jeong, Y. 2006. The landscape of applicatives. Doctoral dissertation. University of Maryland.
- Kayne, R. 1983. Connectedness. *Linguistic Inquiry* 14:223–249.
- Kayne, R. 1989. Null subjects and clitic climbing. In *The null subject parameter*, eds. Osvaldo Jaeggli and Kenneth Safir, 239-261. Dordrecht: Kluwer.

- Kayne, R. 1990. Romance clitics and PRO. In *Proceedings of the North Eastern Linguistics Society Annual Meeting (NELS 20)*, ed. Juli A. Carter, Rose-Marie Dechaine, William Philip, and Tim D. Sherer, 255-302. Amherst, MA: Graduate Linguistic Student Association.
- Kayne, R. 1991. Romance clitics, verb movement, and PRO. *Linguistic Inquiry* 22:647-686.
- Kayne, R. 1998. Overt vs. covert movement. *Syntax* 1.
- Kibrik, A. E (ed). 1999. *Elementy caxurskogo jazyka v tipologiceskom osvescenii*. Moskva: Nasledie.
- Kenesei, I. 1994. Subordinate clauses. In *The Syntactic Structure of Hungarian*, eds. Kiefer Ferenc and É. Kiss Katalin. *Syntax and Semantics* 27. Academic Press.
- Kidwai, A. 2000. *XP Adjunction in Universal Grammar: Scrambling and Binding in Hindi/ Urdu*. New York: Oxford University Press.
- Kim, Kwan-Sup. 1997. Connectivity in copular constructions. Ms., University of Maryland, College Park.
- Kiss, T. 1995. *Infinite Komplementation: Neue Studien zum deutschen Verbum infinitum*. Tübingen: Max Niemeyer Verlag.
- Koopman, H. 2006. Agreement configurations: In defense of “Spec head”. In *Agreement Systems*, ed. C. Boeckx, 159–199. John Benjamins.
- Kornfilt, J. 1990. Naked Partitive Phrases in Turkish. Ms. Syracuse University.
- Koul, O. and K. Wali. 2006. *Modern Kashmiri Grammar*. Springfield. Dunwoody Press.
- Koster J. 1984. On binding and control. *Linguistic Inquiry* 15.3:417-59.
- Koster, J. and R. May. 1982. On the constituency of Infinitives. *Language* 58.1:116-143.
- Kuhn, T.S., *The Structure of Scientific Revolutions*. 2nd. ed., Chicago: Univ. of Chicago Pr., 1970
- Kuroda, S.Y. 1979. On Japanese Passives. *Explorations in Linguistics: Papers in Honor of Kazuko Inoue*, eds. G. Bedell et al., 305-347. Tokyo: Kenkyusha.
- Laka, I. 1993. Unergatives that assign ergative, unaccusatives that assign accusative. In *Papers on Case and Agreement I*. MITWPL 18, eds. J.D. Bobaljik and C. Phillips. 149-177.

- Landau, I. 1999. Elements of Control. Doctoral dissertation. Cambridge, MA: MIT.
- Landau, I. 2000. *Elements of Control: Structure and Meaning in Infinitival Constructions*. Dordrecht: Kluwer.
- Lasnik, H. 1992. Case and expletives. *Linguistic Inquiry* 23:381-405.
- Lasnik, H. 1995. Case and expletives revisited. *Linguistic Inquiry* 26:615-633.
- Lasnik, H. 1998. Exceptional case marking: perspectives new and old. In FASL 6: 187-211. Michigan Slavic Publications.
- Lasnik, H. 2001. A note on the EPP. *Linguistic Inquiry* 32.2:356–62.
- Lasnik, H. and R. Fiengo (1974). Complement Object Deletion. *Linguistic Inquiry* 5.4:535-572.
- Lasnik, H. and M. Saito. 1992. *Move Alpha: Conditions on Its Application and Output*. Cambridge, MA: The MIT Press.
- Lebeaux, D. 1985. Locality and Anaphoric Binding. *The Linguistic Review* 4:343–363.
- Legate, J. 2005. Split Absolutive. In *Ergativity: Emerging Issues*, eds. A. Johns, D. Massam, and J. Ndayiragije, 143-171. Dordrecht: Kluwer.
- Legate, J. 2006. Morphological and abstract case. Ms. University of Delaware.
- Luján, M. 1980. Clitic promotion and mood in Spanish verbal complements. *Linguistics* 18:381-484.
- McCloskey, J. 1986. Inflection and Conjunction in Modern Irish. *Natural Language and Linguistic Theory* 4: 245-282.
- Mahajan, A. 1990. The A/A-bar distinction and movement theory. Doctoral dissertation. Cambridge, MA: MIT.
- Maling, J. 1983. Transitive adjectives: A case of categorial reanalysis. *Linguistic Categories: Auxiliaries and Related Puzzles*, eds. F. Henry and B. Richards, 253-289. Dordrecht: Foris.
- Manzini, M. R. 1983. *Restructuring and Reanalysis*. Doctoral dissertation, MIT.
- Marantz, A. 2000. Words. Ms. MIT.

- Martin, R., D. Michaels and J. Uriagereka, eds. 2000. *Step by step: essays on minimalist syntax in honor of Howard Lasnik*. Cambridge, MA and London: The MIT Press.
- Massam, D. 1985. Case theory and projection principle. Doctoral dissertation. Cambridge, MA: MIT.
- May, R. 1981. Movement and binding. *Linguistic Inquiry* 12:215–243.
- Meurers, W.D. 2000. Lexical generalizations in the syntax of German non-finite constructions. Doctoral dissertation. University of Tübingen.
- Miyagawa, S. 1997. Against Optional Scrambling. *Linguistic Inquiry* 28.1:1-25.
- Miyagawa, S and T. Tsujioka. 2004. Argument structure and ditransitive verbs in Japanese. *Journal of East Asian Linguistics* 13:1-38.
- Moro, A. 1991. The raising of predicates: copula, expletives and existence. *MIT Working Papers in Linguistics* 15: 119-181.
- Moro, A. 1997. *The raising of predicates*. Cambridge University Press.
- Murasugi, K. 1992. Crossing and Nested Paths: NP Movement in Accusative and Ergative Languages. Doctoral dissertation. Cambridge, MA: MIT.
- Napoli, D. 1981. Semantic interpretation vs. lexical governance: clitic climbing in Italian. *Language* 57:841-887.
- Niinuma, F. 2003. The syntax of honorification. Doctoral dissertation. Storrs: University of Connecticut.
- Ormazabal, J. and J. Romero. 2001. Agreement Restrictions. Ms. University Basque Country (EHU)/Basque Center for Language Research (LEHIA) and U. of Alcalá/U. Autónoma de Madrid.
- Pesetsky, D. 2000. Phrasal movement and its kin. Cambridge, MA: The MIT Press.
- Pesetsky, D. and E. Torrego. 2001. T-to-C Movement: Causes and Consequences. In *Ken Hale: A Life on Language*, eds. M. Kenstowicz. Cambridge, MA: The MIT Press.
- Petter, M. 1998. Getting PRO under control. Doctoral dissertation. Netherlands Graduate School of Linguistics (LOT). Amsterdam, The Netherlands.
- Pylkkänen, L. 2002. Introducing Arguments. Doctoral Dissertation, MIT.
- Polinsky, M. 2003. Non-canonical agreement is canonical. *Transactions of the Philological Society* 101.2:279-312.

- Polinsky, M. and E. Potsdam. 1999. 'Long distance agreement in Tsez'. In *Proceedings of the 18th West Coast Conference on Formal Linguistics*, eds. S. Bird, A. Carnie, J. Haugen and P. Norquest.
- Polinsky, M. and E. Potsdam. 2001. Long-Distance Agreement and Topic in Tsez. *Natural Language and Linguistic Theory* 19:583-646.
- Postal, P. 1966. On so-called pronouns in English. In *Modern studies in English*, eds. David Reibel and Sanford Schane, 201–223. Englewood Cliffs, N.J.: Prentice-Hall.
- Postal, P.M. 1974, *On Raising*. Cambridge, MA: The MIT Press.
- Potsdam, E. and J. Runner. 2001. Richard returns: Copy Raising and its Implications. *Proceedings of the Chicago Linguistics Society (CLS)* 37:453–468.
- Raposo, E. 1989. Propositional Infinitival Constructions in European Portuguese. In *The Null Subject Parameter* eds. O. Jaeggli and K. J. Safir. Dordrecht, Kluwer Academic Publishers.
- Raposo, E. and J. Uriagereka. 1990. Long-distance Case assignment. *Linguistic Inquiry* 21: 505-537.
- Raposo, E. and J. Uriagereka. Two types of small clauses. In *Small Clauses*, eds. A. Cardinaletti, M.T. Guasti. Academic Press: 179-206.
- Rezac, M. 2003. The Fine Structure of Cyclic Agree. *Syntax* 6: 156-182.
- Reinhart, T. 2006. *Interface Strategies: Optimal and Costly Computations*. Cambridge, MA: The MIT Press.
- Ritter, E. 1995. On the syntactic category of pronouns and agreement. *Natural Language & Linguistic Theory* 13:405–443.
- Rizzi, L. 1982. *Issues in Italian Syntax*. Dordrecht: Foris.
- Roberts, I. 1993. Restructuring, pronoun movement and head-movement in Old French. Ms., University of Wales, Bangor.
- Roberts, I. 1997. Restructuring, head movement, and locality. *Linguistic Inquiry* 28:423-460.
- Rodrigues, C. 2004. Impoverished Morphology and A-movement out of Case Domains. Doctoral dissertation. University of Maryland.

- Rogers, A. 1974. A transderivational constraint on Richard? *Papers from the Tenth Regional Meeting of the Chicago Linguistic Society*, 551-558. Chicago: Chicago Linguistic Society.
- Rutten, J. 1991. Infinitival complements and auxiliaries, Doctoral dissertation. University of Amsterdam.
- Sabel, J. 1994. Restrukturierung und Lokalität: Universelle Beschränkungen für Wortstellungsvariationen, Doctoral dissertation. University of Frankfurt.
- Sabel, J. 1996. *Restrukturierung und Lokalität: Universelle Beschränkungen für Wortstellungsvariationen*. Berlin: Akademie Verlag.
- San Martin, I. 2004. On Subordination and the distribution of PRO. Doctoral dissertation. College Park: University of Maryland.
- Schütze, C.T. 1997, *INFL in Child and Adult Language: Agreement, Case, and Licensing*. Doctoral dissertation. Cambridge, MA: MIT.
- Shibatani, M. 1977. Grammatical Relations and Surface Cases. *Language* 53.4:789-809.
- Sigurdsson, H.A. 1992. The case of quirky subjects. *Working Papers in Scandinavian Syntax* 49:1-26.
- Sigurdsson, H.A. 1996. Icelandic Finite Verb Agreement. *Working Papers in Scandinavian Syntax* 57: 1-46.
- Sigurdsson, HA. 2000. The locus of Case and agreement. *Working Papers in Scandinavian Syntax* 65:65-106.
- Sigurdsson, H.Á. 2002. To be an oblique subject: Russian vs. Icelandic. *Natural Language and Linguistic Theory* 20:691-724.
- Silverstein, M. 1986. Hierarchy of features and ergativity. In *Features and Projections*, eds. Pieter Muysken and Henk van Riemsdijk, 163–232. Dordrecht: Foris, originally published in R.M.W. Dixon, ed., 1976, *Grammatical Categories in Australian Languages*. Canberra: Australian Institutes of Aboriginal Studies.
- Soltan, U. 2004. An argument for Agree and Multiple Spell-out: Standard Arabic agreement asymmetries revisited. Paper presented at the Workshop on Minimalist Theorizing, Indiana University, Bloomington.
- Stenberg, A.M. 1971. *Finsk Satslára*. Helsingfors: Soderstrom och Co.

- Stjepanovic, S. and S. Takahashi 2001. Eliminating the Phase Impenetrability Condition. Paper presented at the workshop Motivating movement: Explaining the displacement property of natural language, University of Ulster.
- Sternefeld, W. 1990. Scrambling and minimality. In *Scrambling and barriers*, eds. Günther Grewendorf and Wolfgang Sternefeld, 239-257. Amsterdam/Philadelphia: John Benjamins.
- Strozer, J. R. 1976. Clitics in Spanish, Doctoral dissertation. UCLA.
- Subbarao, K. V., and S. Munshi. 2003. Agreement in Kashmiri and Minimalist Inquiries: the Framework. Ms. University of Delhi.
- Svenonius, P. 2001. Impersonal Passives: A Phase-based Analysis. In *Proceedings of the 18th Scandinavian Conference of Linguistics* eds. A. Holmer, J-O. Svantesson and A. Viberg. Travaux de l'Institut de Linguistique de Lund.
- Svenonius, P. 2002. Icelandic Case and the Structure of Events. *Journal of Comparative Germanic Linguistics* 5: 197-225.
- Szabolcsi, A. 1983. The possessor that ran away from home. *The Linguistic Review* 3: 89-102.
- Takahashi, D. 1994. Minimality of movement. Doctoral dissertation. Storrs: University of Connecticut.
- Takahashi, M. 2006. A study of Case and Agreement in Japanese: A view from honorification and case-related phenomena. M.A. Thesis. Sendai: Tohoku University.
- Taraldsen, K.T. 1981. Case-conflict in Norwegian topicalization. In *Proceedings of the eleventh annual meeting of the North Eastern Linguistic Society*, eds. V. Burke and J. Pustejovsky, 377-398, Graduate Linguistics Students Association, University of Massachusetts, Amherst.
- Taraldsen, K. T. 1995. On agreement and nominative objects in Icelandic. In *Studies in comparative Germanic syntax*, eds. Hubert Haider, Susan Olsen, and Sten Vikner, 307–327. Dordrecht: Kluwer.
- Taylor, H. L. 2006. Out on Good Syntactic Behavior. General Paper. University of Maryland.
- Thrainsson, H. 1979. *On Complementation in Icelandic*. New York: Garland Publishing.
- Thrainsson, H. 1985. Case and Grammatical Functions: the Icelandic Passive. *Natural Language and Linguistic Theory* 3: 441-483.

- Toribio, A. J. 1990. Specifier-head agreement in Japanese. In *Proceedings of the 9th West Coast Conference on Formal Linguistics (WCCFL 9)*, ed. Aaron L. Halpern, 535-548. Stanford: Stanford Linguistics Association.
- Torrego, E. and J. Uriagereka. 2002. Parataxis. In Uriagereka 2002.
- Toth, I. 2000. *Inflected infinitives in Hungarian*. Doctoral dissertation. Tilburg University.
- Trask, R.L. 1995a. *Language: The Basics*. London: Routledge.
- Trask, R.L. 1995b. Origin and Relatives of the Basque Language: Review of the evidence. In *Towards a History of the Basque Language*, ed. J. I. Hualde et al., Amsterdam/ Philadelphia: John Benjamins, 1995.
- Travis, L. 1984. Parameters and Effects of Word Order Variation. Doctoral dissertation. Cambridge, MA: MIT.
- Ura, H. 1994. *Varieties of raising and the feature-based bare phrase structure theory*. MIT Occasional Papers in Linguistics 4. Cambridge, MA: MITWPL.
- Ura, H. 2001. Case. In *The Handbook of Contemporary Syntactic Theory*, eds. Mark Baltin and Chris Collins, 334-373. Oxford: Blackwell.
- Uriagereka, J. 1998. *Rhyme and Reason: An Introduction to Minimalist Syntax*. Cambridge, MA: The MIT Press.
- Uriagereka, J. 1999. Multiple spell-out. In *Working minimalism*, eds. D. S. Epstein and N. Hornstein, 251-282. Cambridge, MA.: The MIT Press.
- Uriagereka, J. 2000. Some thoughts on Economy within Linguistics. *D.E.L.T.A., Vol. 16, N. ESPECIAL*, 221-243.
- Uriagereka, J. 2002. *Derivations*. Routledge.
- Vainikka, A. 1989. Deriving syntactic representations in Finnish. Doctoral dissertation. Amherst, MA: University of Massachusetts.
- Wali, K. and O.N. Koul. 1997. *Kashmiri*. London: Routledge
- Williams, E. 1980. Predication. *Linguistic Inquiry* 11, 203-238.
- Williams, E. 1994. *Thematic Structure in Syntax*. Cambridge, MA: The MIT Press.

- Wurmbrand, S. 1997. Restructuring infinitives. In *Proceedings of ConSOLE 5*, ed. Tina Cambier-Langeveld, João Costa, Rob Goedemans, and Ruben van de Vijver, 277-292. Leiden.
- Wurmbrand, S. 1998a. Deconstructing restructuring. In *Document de travail langues et grammaire 7: Langues et grammaire III - syntaxe; Communications présentées aux Colloques Langues et Grammaire III*, ed. Patrick Sauzet, 195-215. Paris 8.
- Wurmbrand, S. 1998b. Downsizing infinitives. In *MIT Working Papers in Linguistics 25: The interpretive tract*, ed. Uli Sauerland and Orin Percus, 141-175. Cambridge, MA: MIT.
- Wurmbrand, S. 1998c. Infinitives, Doctoral dissertation. Cambridge, MA: MIT.
- Wurmbrand, S. 1998d. Restructuring control. In *UPenn Working Papers in Linguistics 5.1: Proceedings of the 22nd annual Penn Linguistics Colloquium*, eds. Alexis Dimitriadis, Hikyoung Lee, Christine Moisset, and Alexander Williams, 175-188. Philadelphia: University of Pennsylvania.
- Wurmbrand, S. 2001. *Infinitives: Restructuring and Clause Structure*. Mouton de Gruyten.
- Wurmbrand, S. 2004. Two types of restructuring-Lexical vs. functional. *Lingua* 114: 991-1014.
- Yatsushiro, K. 1999. Case licensing and VP structure. Doctoral dissertation. Storrs: University of Connecticut.
- Zaenen, A., J. Maling, and H. Thrainsson. 1985. Case and Grammatical Functions: The Icelandic Passive. *Natural Language and Linguistic Theory* 3: 441-483.