

ABSTRACT

Title of Document: Experimental Investigations of Whisker Formation on Tin Platings

Yuki Fukuda, Doctor of Philosophy, 2005

Directed By: Professor Michael G. Pecht,
Department of Mechanical Engineering

With the global transition to lead-free electronics, the electronic component market has seen an increase in the selection of pure tin and tin-rich alloys as lead-free component finishes. The adoption of tin-rich finishes has enhanced a reliability issue associated with the formation of electrically conductive whiskers, emanating from tin finished surface. A spontaneous growth of whisker may bridge adjacent conductors, leading to current leakage or electrical shorts.

Whiskers tend to grow over many months. However, due to a lack of the factors accelerating whisker growth, prediction of whisker formation is extremely difficult. Therefore, the effective mitigation strategies are necessary, particularly for high-reliability applications, which require a long product operational life. The objective of this study is to investigate a method for characterizing whisker growth, which can further enable measuring the effectiveness of mitigation strategies.

To achieve this objective, a set of experiments was conducted using matte and bright tin platings on copper, Alloy-42, and brass metal coupons. The plated coupons

were subjected to high temperature exposures, including annealing (at 150°C/one hour). Whisker growth on tin-plated samples was characterized using environmental scanning electron microscopy, in terms of the maximum whisker length, length distribution, and whisker density, at different time periods up to 24 months.

The experimental results have shown different behaviors of whisker growth (length and density) between bright and matte tin, depending on the materials and exposure conditions. It was experimentally demonstrated that bright tin over brass could be considered a worst-case scenario for assessing the risks associated with tin whiskers. This work has further revealed that the current industry practice of testing for 3000 hours for monitoring the propensity of tin whiskers is insufficient to cover a saturation of whisker density and capture the temporal nature of whiskers. In order to overcome such insufficiencies, the use of time-based distribution data for whisker length and whisker density was proposed as an alternative method for characterizing whisker growth. With the application of this proposed method, the effect of annealing (150°C/one hour) and its effect under the presence of electrical current were investigated for retarding whisker formation and growth on tin-plating.

EXPERIMENTAL INVESTIGATIONS OF WHISKER FORMATION ON TIN
PLATINGS

By

Yuki Fukuda

Dissertation submitted to the Faculty of the Graduate School of the
University of Maryland, College Park, in partial fulfillment
of the requirements for the degree of
Doctor of Philosophy
2005

Advisory Committee:
Professor Michael G. Pecht, Chair
Professor Bilal M. Ayyub
Associate Professor Patrick F. McCluskey
Associate Professor Peter Sandborn
Assistant Professor Bao Yang

© Copyright by
Yuki Fukuda
2005

Acknowledgements

I would like to express my appreciation to Professor Michael Pecht for his guidance and for giving me an opportunity to work at CALCE Electronic Products and Systems Center at the University of Maryland. I would also like to appreciate to Prof. Ayyub, Dr. McCluskey, Dr. Sandborn, and Dr. Yang for their help and advices.

I'm greatly thankful to Dr. Michael Osterman, who patiently oversees my research and provided me with insightful suggestions and stimulating discussions on this dissertation work over the last two years. I've also wanted to take this opportunity to thank all research scientists, especially Dr. Sanka Ganesan, Dr. Michael Azarian, and Dr. Keith Rogers, for their technical supports and advices. I wish to acknowledge Tong Fang for his support in this project. My thanks also extend to colleagues, whom I met throughout my stay in Maryland, for their help and good company.

I feel very fortunate to have met Nikhil Vichare, who always inspires, motivates, and understands me. Without his presence, support, and advices, this work would not have seen a fruitful completion.

Finally, I would like to thank my parents and family for their unconditional, permanent support and understanding.

Table of Contents

Acknowledgements	ii
Table of Contents	iii
List of Tables	iv
List of Figures.....	v
Chapter 1. Introduction.....	1
1.1 Transition to Lead-free Electronics	1
1.2 Lead-free Material Selection	2
1.3 Lead-free Electronic Component.....	3
1.4 Tin Whiskers.....	7
1.5 Problem Statement.....	11
1.6 Objectives and Scope of Study	12
1.7 Dissertation Overview	14
Chapter 2. Previous Studies on Tin Whiskers.....	16
2.1 Tin Whisker Growth Mechanisms	16
2.2 Risks from Tin Whiskers	19
2.2.1 Failure Mode.....	19
2.2.2 Failure Experiences.....	21
2.3 Risk Assessment and Management.....	22
2.4 Mitigation Strategies.....	24
2.4.1 Part Selection Strategies	25
2.4.2 Assembly Process Strategies.....	26
2.5 Effects of the Selected Parameters.....	28
2.5.1 Type of Pure Tin Plating and Substrates.....	28
2.5.2 High Temperature Exposures	30
2.5.3 Bending.....	32
2.5.4 Electrical Current	33
Chapter 3. Approach: Overview of Experiments.....	36
3.1 Experimental Procedure: Experiment-1.....	36
3.2 Experimental Procedure: Experiment-2.....	38
3.3 Adopted Inspection Methods	40
3.3.1 Sample Method and Verification	42
3.3.2 Data Analysis of Whisker Length and Whisker Density	43
Chapter 4. Observations and Discussions.....	50
4.1 Bright Tin versus Matte Tin.....	50
4.2 Saturation in Whisker Density	56
4.3 Effect of High Temperature Exposures	58
4.4 Effect of Electrical Current.....	63
4.4.1 Whisker Density.....	64
4.4.2 Whisker Length.....	65
Chapter 5. Conclusions.....	70
Chapter 6. Contributions.....	74
Appendices.....	76
Bibliography	87

List of Tables

Table 1: Comparison of various lead-free component finishes [21], [22].....	4
Table 2: Examples of reported characteristics of tin whisker growth	9
Table 3: Examples of reported growth rate of tin whiskers.....	10
Table 4: Examples of field failures attributed to tin whiskers	21
Table 5: Product classes and levels of whisker risk tolerance [84]	23
Table 6: Example of the suppliers' tin whisker testing.....	24
Table 7: Comparison of Three Experiments.....	34
Table 8: Example of parametric analysis of distribution fitting	45
Table 9: Test-statistics and critical values for the goodness-of-fit test ([118], [120])	45
Table 10: Example of inputs to ANOVA	48
Table 11: Example results from ANOVA	48
Table 12: Definition of bright tin and matte tin finishes	50
Table 13: Comparison of grain size (experiment-2).....	51
Table 14: Change in mean whisker length on matte tin over copper.....	61
Table 15: Source of Variances, ANOVA	76

List of Figures

Figure 1: Increase in tin-rich finished parts	6
Figure 2: Selection of lead-free finishes	6
Figure 3: Whisker growth: needle-like filament	8
Figure 4: Whisker growths: columnar shape	8
Figure 5: Tin-copper intermetallics	17
Figure 6: Whiskers grown along scratches on bright tin plated copper.....	18
Figure 7: Test flow chart.....	38
Figure 8: Selected reflow profile	38
Figure 9: Bending method	39
Figure 10: Circuit diagram.....	40
Figure 11: Observation sites	40
Figure 12: Total axial length of whisker.....	42
Figure 13: Number of whiskers observed at each inspection	43
Figure 14: Average number of whisker growth, with increase in inspection sites	43
Figure 15: Example of A-D test result (probability plot)	46
Figure 16: Kernel density plot	47
Figure 17: Grain size of pure tin finish (experiment-1).....	51
Figure 18: Whisker growth and depletion of tin surface on bright tin.....	52
Figure 19: Whisker growth on matte tin	52
Figure 20: Needle-like whiskers	54
Figure 21: Whisker length comparison with respect to substrate material	54
Figure 22: Whisker length comparison with respect to annealing.....	55
Figure 23: Change in whisker density with time (bright and matte tin)	56
Figure 24: Saturation in whisker density (matte tin over copper)	58
Figure 25: Relative comparison of whisker length on matte tin	59
Figure 26: Change in whisker length (non-annealed, matte tin over copper).....	61
Figure 27: Change in whisker length (annealed, matte tin over copper)	61
Figure 28: EDS analysis for matte tin over brass sample	62
Figure 29: Whisker growths on bright tin in the presence of electrical current	64
Figure 30: Whisker density comparison for bright tin.....	65
Figure 31: Whisker density comparison for matte tin	65
Figure 32: Whisker length comparison for bright tin	66
Figure 33: Whisker length comparison for matte tin	66
Figure 34: Effect of annealing on whisker length on matte tin.....	68
Figure 35: Comparison of whisker length due to bending (bright tin)	68
Figure 36: Comparison of whisker length due to bending (matte tin).....	69

Chapter 1. Introduction

A rapid industrial growth in electronics has given rise to increased awareness regarding environmental responsibility. Various regulatory actions are being proposed, which require electronics manufacturers to take responsibilities including the use of ‘green’ materials and the recycling of important resources for environmental protection. The most significant international action is the European directive on the Restriction of Hazardous Substances (RoHS), which prohibits the manufacture and selling of various electronic products containing lead and other hazardous substances after July 2006 [1]. Due to the global nature of the electronics industry, an expedient transition to lead-free electronics has become necessary for most electronics industry sectors. Although numerous solutions and developments of lead-free materials and products are already in place, significant changes in materials, design, processes, and supply chain, have prompted reliability concerns pertinent to the implementation of lead-free electronics.

1.1 Transition to Lead-free Electronics

In order to enhance the recycling and decrease the negative health impact of hazardous substances in electronics, the European Union finalized two directives on the Waste Electrical and Electronic Equipment (WEEE) and its supplementary RoHS directive in 2003 ([1], [2]). The RoHS directive requires the elimination of lead, mercury, cadmium, hexavalent chromium, polybrominated biphenyls (PBBs), and polybrominated diphenyl ethers (PBDEs) in electrical and electronic products after July 1st 2006.

Lead has been used in a wide range of electronics applications, including solder interconnection, component terminal finishes, solder balls of area-array packages, and the surface finish of printed circuit boards (PCB). However, lead is a toxicant substance. When lead is present in the discarded electronic products in landfills, it may cause environmental threats by leaching into and contaminating the ground water.

Since the consequences of not meeting the RoHS deadline may translate into exclusion from European, and possibly global markets, most electronics industry sectors are faced with an expedient transition to lead-free electronics [3]. The electronics manufacturers in U.S. are also in the process of lead-free changeover, although there is no pending regional legislation mandating the removal of lead. Much prior to a ban, proactive developments of lead-free materials and products were often observed in Japan and Europe, where many companies had envisioned economic rewards from producing lead-free products before the competition [4].

1.2 Lead-free Material Selection

As a result of extensive industry-wide efforts, various lead-free materials, products, and systems are in the market. However there is no single drop-in replacement for lead-based materials, which have been in use over the last forty years in the electronics industry. The adoption of lead-free materials and processes has often prompted new reliability concerns [5], due to different alloy metallurgies and higher process temperatures relative to tin-lead soldering. In order to ensure reliability of lead-free product while maintaining reasonable costs, various lead-free materials for the solder joint interconnects (e.g., [6]-[10]), component finishes (e.g.,

[11]-[13]), or the surface finish of printed circuit board (e.g., [14]-[16]), have been investigated.

1.3 Lead-free Electronic Component

To conform to the RoHS legislation imposing the use of lead-free products, most electronic part manufacturers have also sought lead-free finishes to replace the traditionally used tin-lead finishes. The finish selection is important in providing corrosion resistance, good solderability, durable solder joints, and an electrically conductive pathway through the surface of the component. For example, metallurgical incompatibility between the solder alloy and the terminal finishes should be avoided, since it could result in solder joint brittleness, low strength, or lack of thermal fatigue resistance [17].

For array components, tin-silver-copper alloy is the leading replacement for the conventional Sn-36Pb-2Ag alloys or eutectic tin-lead (Sn-37Pb) solders. For the peripheral components, currently available lead-free finishes are broadly classified into two categories, i.e., tin-based finishes and to lesser-extent noble-metal (nickel-palladium-gold and nickel-gold) platings. The advantages of tin and tin-alloys include excellent corrosion resistance, good electrical conductivity, and ability to protect a base metal from oxidation. The tin-based finishes have been widely selected in the electronics industry, while the palladium pre-plated leadframe (PPF) is used in approximately 10% of the leadframes in industry (as of May 2005) [18]. The PPF is created by plating an entire leadframe with noble metal prior to component encapsulation process. Thus, the advantages of PPF include the shorter cycle time for assembly, higher resistance to whisker formation, and improved processability, such

as bondability, moldability, and minimization of solder cracking during trim and form [19], [20]. However, the adoption of PPF may lead to additional cost of palladium, poor adhesion with Alloy-42 substrate, solder joint embrittlement, and creep corrosion. When there exist exposed copper on leads, creep corrosion¹ may initiate by reacting with corrosive elements in the atmosphere and will be a potential reliability risk for the electronic packages, especially when a long-term operation period is required [13]. Table 1 provides a comparison of lead-free finishes available for the leaded packages.

Table 1: Comparison of various lead-free component finishes [21], [22]

Type of finish, (melting point)	Advantages	Disadvantages
Pure tin (232°C)	-Lowest cost -Wide availability -Least requirement for change in existing process/equipment	-Poor resistance to oxidation -Whiskers
Tin-bismuth (212°C)	-Good solderability -Relatively easy to control the deposit process -Less costly than palladium-containing plating	-Toxicity of bismuth -Difficult process control and control of chemical content (since Bi content in the solution drops rapidly) -Instability in the presence of lead -Whiskers
Tin-copper (227°C)	Good mechanical characteristics	-Poor wetting characteristics -Whiskers -Plating chemical is very difficult to control Must control copper content between 0.7~3.0% -Poor resistance to oxidation

¹ Creep corrosion is a mass-transport process during which solid corrosion products migrate over a surface [13]

Tin-silver (221°C)	Good solderability	<ul style="list-style-type: none"> -High cost due to silver -Difficult process control- compositional control -Corrosion in the case of H₂S -Complexity in waste water treatment
Nickel/ palladium/ gold or Nickel/gold	<ul style="list-style-type: none"> -Good resistance to oxidation and corrosion -Experiences in the market for ten years 	<ul style="list-style-type: none"> -High cost due to palladium -Creep corrosion -More susceptible to surface damages -Limited applicability to Alloy-42 leadframe

In order to track the type of lead-free finishes, selected by electronic part suppliers, a survey was conducted among 121 part suppliers in U.S. during 2003-2005. As shown in Figure 1, the electronic component market has clearly seen an increase in the selection of pure tin and tin-rich alloys as the preferred finish. This preference mainly stems from the advantages of tin-rich alloys, including low cost, good processability, good corrosion resistance, and compatibility with both conventional tin-lead and lead-free solders. A breakdown of selected lead-free finishes is given in Figure 2. It should be noted that the most preferred tin-rich finish may vary country-by country. For instance, tin-bismuth is the most widely adopted lead-free finish for leaded packages in the Japanese electronics industry, as opposed to pure tin in U.S. (as this time of writing) [23].

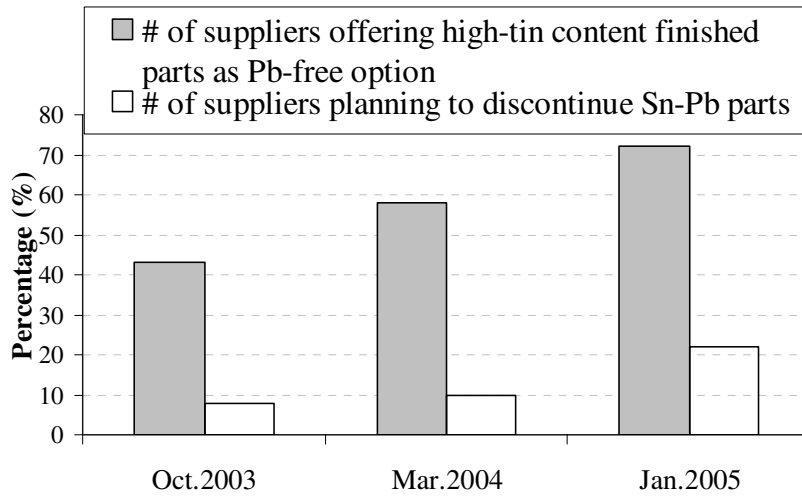

Figure 1: Increase in tin-rich finished parts

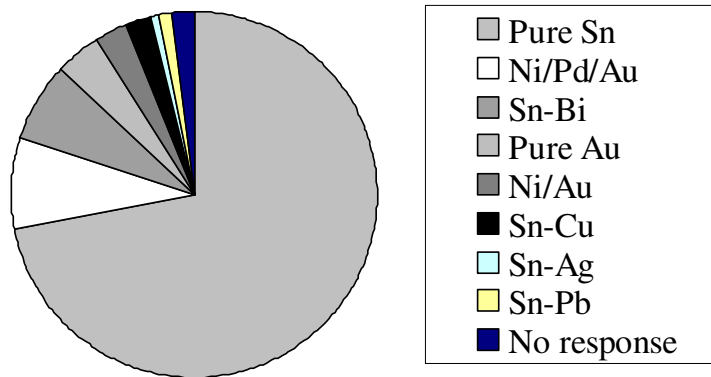

Figure 2: Selection of lead-free finishes

The European Union's RoHS legislation provides a list of exemptions, considering the mission-criticality of the system or applications and the technological limitation in the alternative materials and processes [24]. However, regardless of such exemptions, limited availability of critical lead-based parts and their

discontinuation (Figure 1) may be inevitable, since the electronic part market is typically driven and supported by large-volume industry segments, such as telecommunication and computer applications. Due to lack of lead-based parts and increased usage of lead-free components, it will likely be a challenge for smaller market segments, such as military/space electronics segments (less than 2% of the total electronics market [25]), to control over the part selection, neither driving nor resisting the transition to lead-free electronics. In other words, even when pure tin and tin-rich lead-free finishes are undesired, there is a high likelihood that this type of finish will end up somewhere in the system [26].

1.4 Tin Whiskers

The reliability concerns associated with the use of pure tin and tin-rich alloys are tin whisker formation and to a much lesser extent tin pest [27]. Although both physical phenomena have been known for centuries, their occurrence in conventional tin-lead soldering and plating finishing materials has been significantly rare.

Tin pest is an allotropic transformation of ordinary white tin (β -tin) into powdery gray tin (α -tin) at 13°C. Publications ([27], [28]) indicate that increase in volume, associated with allotropic transformation of tin, may lead to crack initiation in the solder joint, when it is subjected to higher strain. However, the relevance of this metallurgical phenomenon is still doubtful, since there are no reported field failures, caused by tin pest, in real engineering applications.

Pure tin and even high tin content (>97%) finished surfaces can potentially form electrically conductive whiskers. Tin whiskers are spontaneous growth of mono-

crystalline tin [29] (Figure 3, Figure 4), which can be formed during electro-deposition and sometimes spontaneously during storage or service, after finishing [30]. However, tin is the most prevalent metal with relatively high whiskering potential in electronic circuits. Potential sites of tin whisker formation in electronic systems include component terminals, the internal and external surface of metal lids, PCB surface finishes, mechanical fasteners, electronic connectors, and shielding materials.

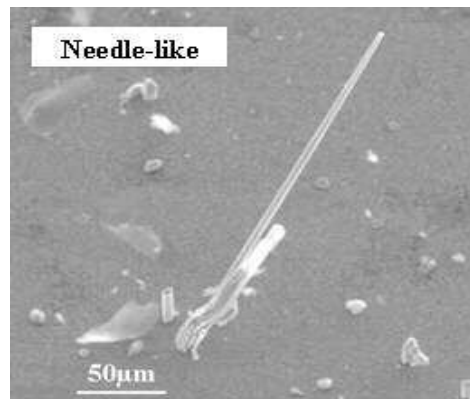

Figure 3: Whisker growth: needle-like filament

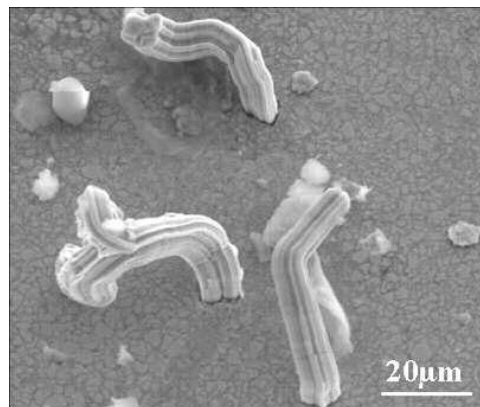

Figure 4: Whisker growths: columnar shape

The whisker growth is not the same as dendrites. Dendrites are conductive metal filaments, which grow on the surface, provided with the presence of an electrolytic solution and a DC voltage bias [31]. Whiskers can be in a variety of shapes including needle-like filament, kinked, bent, forked, and lumps [32].

In order for whiskers to form, tin must migrate to the whisker site. Since the original shape and characteristics of surface, which whisker initiated from, are maintained at the tip of whisker, whiskers are believed to grow as a result of added tin atoms at the base of whiskers, as opposed to at the tip of whiskers [33]. However, it is unclear if the tin moves along the surface or from under the surface. It may very well come from both routes. Due to an absence of local thinning of electroplate at the base of whisker crystals, Key [34] pointed out that the atom transport mechanism in whisker growth is long range.

To date, a wide variation in the growth characteristics, including length (0.3-10 mm), density (3-500 whiskers/mm²), growth rate, and incubation time (days to years) [34] have been reported. Some examples of the reported whisker characteristics are given in Table 2.

Table 2: Examples of reported characteristics of tin whisker growth

Reference	Reported characteristics of tin whiskers		Examined sample
	Diameter	Length	
Koonce [32]	0.05-5.8 μ m	Not reported	Tin over steel
Fisher [35]	1 μ m	Not reported	Electroplated tin over steel
Kehrer [36]	0.4-2.0 μ m	2000-33000 μ m	Not reported
Franks [37]	Rarely more than 2 μ m	Rarely more than 1000 μ m, up to 5000 μ m observed	Electroplated tin over steel
Tu [38]	Not reported	0.1mm	Not reported

Cunningham [39]	3.3 μm (Filament) 7.4 μm (Nodule)	254 μm , up to 1320 μm (Filament) 17.8 μm (Nodule)	Tin (hot tin dip) over aluminum
Hada [40]	Not reported	4000 μm	Electroplated bright tin
ASTM B545 [41]	2.5 μm	up to 10000 μm	Not reported
Arnold [42]	Few μm	100 to 5000 μm	Not reported
Brusse [43]	Not reported	800 μm	Electroplated matte tin

The rate of growth is not necessarily constant, and whisker growth may stop upon reaching a certain length or interrupt itself. In 1954, Fisher, et al, [35], were the first to discuss whisker growth rate as a function of the applied pressure. He concluded that the rate of growth is proportional to the applied pressure. However, values reported in the literature still vary (0.03-9mm/year), as evident from the reported whisker growth rate given in Table 3. Further, whiskers tend to have an incubation time², which could be days to years [44]. Consequently, whisker propensity is difficult, if not possible, to predict.

Table 3: Examples of reported growth rate of tin whiskers

Reference	Reported growth rate of tin whisker
Fisher [35]	10,000 $\text{\AA}/\text{sec}$ (linear growth rate: 1 $\text{\AA}/\text{sec}$) with an application of pressure up to 7500 Psi
Hasiguti [45]	Growth rate = $DP a^3/RkT$ cm/sec where, D: self diffusion coefficient of tin at temperature T, P: Pressure, a: atomic spacing, R: distance between the dislocation spiral and the region where the pressure P is maintained
Tu [38]	0.2 $\text{\AA}/\text{sec}$
Key [34]	1.016mm/month
Kadesch [46]	0.13-0.80mm/year
Tu [47]	0.2 $\text{\AA}/\text{sec}$

² The incubation time is defined as the amount of time for the whisker phenomenon to appear.

1.5 Problem Statement

The continued adoption of tin-rich lead-free finishes has created a reliability issue in the electronics industry, pertaining to the formation of conductive tin whiskers, which can cause current leakage or electrical shorts, leading to failure between adjacent conductors. Numerous field failures have been attributed to tin whiskers as early as in 1940s [48] and resulted in losses of at least a billion dollars to date [26].

Despite its 60-year history and recent extensive industry-wide studies on tin whiskers, the growth mechanism(s) of tin whiskers are not yet clearly understood. Although a test standard now exists and electronic part manufacturers are gaining experiences with their selected lead-free finishes, the randomness in whisker growth and lack of an acceleration method to induce whiskers continue to nag at the industry. None of the proposed tin whisker test methods and conditions have been proven to be effective discriminators for safe/unsafe (i.e., whisker-free or not) tin platings in terms of whisker propensity, and to be correlated with any particular field use environment [26]. In other words, there is currently no way to quantitatively predict whisker lengths over long time periods based on the lengths measured in the short time test.

This fact also raises questions with respect to the effectiveness of proposed mitigation strategies. There has not yet been established a guaranteed method of avoiding whisker growth. Particularly for products when high reliability and safety are critical, the effective strategies to retard the formation or growth of whiskers are needed. Due to limited component availability (coupled with obsolescence of leaded materials), avoiding pure tin is not a feasible option. In addition, redesigning a

system to incorporate the use of other lead-free finished parts is not a practical option for these costly electronic systems. Further complicating the matter, existing risk assessment metrics and electronic part manufacturers' acceptance criteria for tin whiskers are not yet sufficient to assess and quantify the actual risks posed by whiskers.

1.6 Objectives and Scope of Study

The objective of this dissertation is to investigate a method for characterizing whisker growth, which can further enable measuring the effectiveness of mitigation strategies. Since there exist many factors influencing whisker formation and growth, and their interaction and effects on growth are still elusive, it is by no means straightforward to generalize the effect of each factor. A set of experiments was conducted and the data on whisker length, density, and their distribution were analyzed to characterize the whisker growth under the selected exposure conditions. This dissertation work attempts to understand several aspects of tin whisker growth by answering the following questions:

- Can bright pure tin be used as a worst-case scenario of the growth of tin whiskers?
- Does whisker density saturate?
- Is maximum whisker length a sufficient measure to characterize the whisker growth and evaluate the effectiveness of annealing (or other mitigation strategies)?

- Can the effectiveness of annealing (150°C/one hour) in reducing the growth of whiskers be maintained in room ambient storage for a long duration?
- Can annealing be effective under temperature/humidity exposure at 50°C/50%RH to retard the growth of whiskers?
- Does electrical current (48 A/cm²) affect the growth of whiskers?

In this dissertation, the growth of whiskers was examined on electroplated pure-tin finishes. Although whiskers have been reported to grow in the solid phase from the bulk material [50] and from the vapor deposition [51], electrodeposited finishes are most susceptible to whiskers due to the high current densities involved in the plating process. Further, the electrodeposition has been preferred, particularly for finishing the electronic components with finer-pitches.

The conventional tin-lead platings were not included in the experiment, since whisker lengths, typically reported on tin-lead plating, are known to be much shorter, as compared to other tin-based finishes ([39], [52]-[54]). In fact, Pitt and Henning [55] observed a decrease in whisker propensities with increased lead (Pb) content in tin-lead plating.

Commonly used tin alloys, including tin-lead, tin-bismuth, and tin-copper also have the potential for whisker formation. Tin-copper finish was reported to have the longest whisker in various literatures (e.g., [21], [56]). For example, Nakadaira [57] reported a comparison of maximum observed whisker lengths on tin-based finishes, which were subjected to 60°C/95%RH exposure condition:

Sn-0.7Cu (120 μ m) > Pure Sn (80 μ m) > Sn-2Bi (50 μ m) > Sn-15Pb (40 μ m)

Mainly due to the high preference for pure tin finishes among electronic part suppliers, the scope of this dissertation covers only pure tin.

1.7 Dissertation Overview

Chapter 1 provides an introduction to this dissertation research. A review of the electronic component market is given in order to describe significant material changes in the electronic component market, as the result of the global movement to lead-free electronics. Followed by a brief introduction of tin whiskers, the problem statement, objectives, and scope of this research are also presented in this chapter.

The second chapter reviews the previous studies on tin whiskers, including growth mechanisms, field failure experiences attributed to tin whiskers, and the proposed mitigation strategies. This chapter also encompasses discussions on the effects of selected parameters (e.g., type of plating, exposure conditions) with respect to relevant previous studies as well as uniqueness of the current study.

Chapter 3 outlines an experimental approach, taken to achieve the objectives of this dissertation research. Test procedures for two sets of experiments are described, along with inspection methods adopted in the course of two years experiment. Some of the adopted statistical analysis methods in this study are further described in Appendix.

The observation results and associated discussions are presented in Chapter 4, in such a way that the answers to the formulated questions are explained in each

subsection. Last of all, conclusions and contributions of this dissertation are provided in Chapters 5 and 6, respectively.

Chapter 2. Previous Studies on Tin Whiskers

2.1 Tin Whisker Growth Mechanisms

Proposed mechanisms for tin whisker growth include diffusion-related dislocation model ([58], [59]), crack tin-oxide model [60], and recrystallization model ([47], [61]-[63]). Although a consensus on a single whisker growth mechanism has not yet been agreed, it is widely agreed that compressive stress, generated within the tin plating, is a necessary factor influencing tin whisker growth ([64], [65]). Compressive stress may result from the formation of intermetallic compounds (IMC) due to the interaction between the tin plating and the substrate material, or presence of residual stress in the tin deposit from electroplating process, mechanical loading, surface damage, and mismatches in coefficient of thermal expansion (CTE) of the plating and substrate or underlayer [66].

The growth of IMCs is a diffusion-based phenomenon. The intermetallic layer itself will not necessarily lead to compressive stresses in the tin deposit, if the intermetallic layer is formed uniformly [67]. However, an irregular, scallop-like IMC can be formed, when the dominant diffusion occurs through grain boundaries or dislocations [65]. For example, in the case of tin plated copper leadframe, irregular-shaped intermetallics of Cu_6Sn_5 is formed at room temperature [64]. (Figure 5 illustrates the presence of irregular shaped Cu_6Sn_5 IMC in this experiment). The Cu_3Sn intermetallic, which is formed subsequently to Cu_6Sn_5 , is believed to prevent non-planar Cu_6Sn_5 IMC from growing further and adding to the compressive stress within the deposit. The different densities of materials (copper, tin, Cu_6Sn_5 , and

Cu_3Sn have a density of 8.9, 7.9, 8.3, and 11.3 g/cm^3 respectively [68]) also appear to be a contributing factor influencing compressive stress. Furthermore, IMC growth will alter the lattice structure especially around grain boundaries, which results in compressing the remaining tin layer and applying tension to the substrate [69]. With the introduction of an underlayer, such as nickel, it is possible to delay the intermetallic growth, because tin-nickel intermetallics (e.g., Ni_3Sn_4) grow slower than tin-copper IMC. The beneficial influence of a nickel underlayer for retarding whisker growth has been reported in various studies ([40], [60], [70]-[72]).

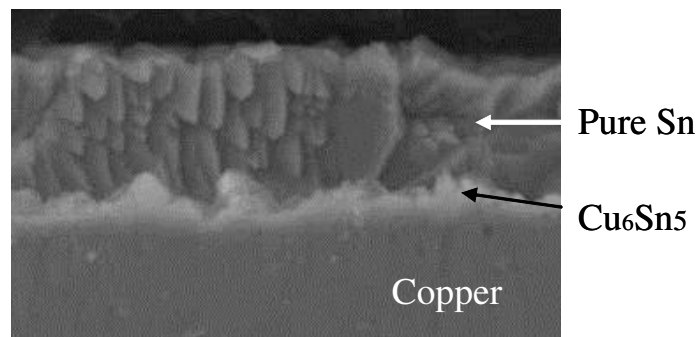

Figure 5: Tin-copper intermetallics

The electroplating chemistry and process, including impurities, organic additives, and current density of the plating bath, will affect the level of stress in the deposit. Electro-deposited finishes are considered to be more susceptible to whiskering, because they induce lattice defects (e.g., dislocations and vacancies) and stacking faults, which result in residual stresses [69]. However, mechanically applied extrinsic stress after plating has been shown to have much stronger influence on whisker formation [54].

Mechanical loading, such as that introduced in the lead formation process can also create localized stress. For example, high compressive pressure from bolts or screws has been shown to produce whiskers in tin deposits [31]. Surface damage and imperfections, including scratches and nicks, can also create stress and may act as a nucleation point for whisker formation. In this study, higher whisker propensities were observed along areas of surface damage.

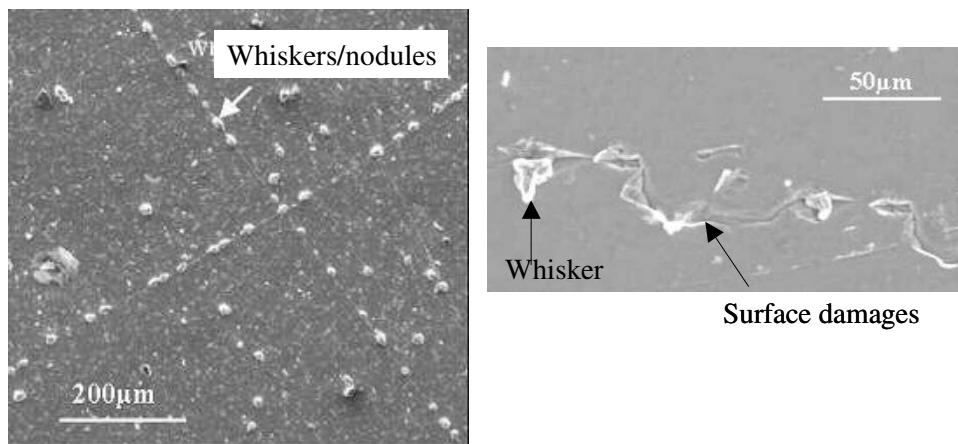

Figure 6: Whiskers grown along scratches on bright tin plated copper

The difference in the coefficient of thermal expansion (CTE) between the tin finish and the substrate material, or the underlayer is another source of compressive stress. For instance, under thermal cycling conditions, whisker formation has been observed to be accelerated for Alloy-42 [73].

When the tin-rich coatings are exposed to thermal excursion, the tin oxide, either stannous oxide (brownish-black compound, SnO) or stannic oxide (gray-white compound, SnO₂), will be formed at the surface. The higher temperature and longer

exposure duration result in the thicker surface oxide. Schetty [71] reported the thickness of oxide layer as 26 Å for as-plated samples, compared to the layer thickness of 45 Å for the annealed (150°C) samples, based on Sequential Electrochemical Reduction Analysis. Zhang [60] measured by X-ray Diffraction that the presence of tin oxide layer did not induce stress within the tin plating. However, it could physically prevent the whisker from penetrating through the surface as far as the oxide layer covers the tin surface [67].

2.2 Risks from Tin Whiskers

Whisker, particularly the needle-like whisker, is a major concern for the electronics industry, since it can bridge adjacent conductors, leading to current leakage or electrical shorts. Numerous electronic field failures have been attributed to tin whiskers and resulted in loss of millions of dollars ([26], [43]).

Due to lack of accepted methods for assessing tin whisker growth susceptibility and the probability of associated failures, tin whiskers raise considerable reliability issues, particularly for the high-reliability product community (e.g., space, military, and high-end computer servers and storage).

2.2.1 Failure Mode

The potential risks induced by whiskers include current leakage, electrical shorts, metal vapor arcing at low-pressure condition, and a source of debris and contamination ([29], [43], [74]). The potential for failure increases with system miniaturization.

Conductive whiskers can create shorts by bridging two adjacent conductors at different potential. Bridging can occur either when a sufficiently long whisker reaches an adjacent conductor from its original growth site, or when an entire whisker or a section of it breaks off and is displaced from its original growth site. Due to its extremely small size and weight, broken whiskers may float with an airflow and fall onto locations where they can cause bridging. The weight of whisker can be estimated³ as 1.47×10^{-9} gram, assuming a perfect columnar shape of 50 μ m-long whisker with a diameter of 2 μ m. However, the chances of whiskers breaking due to vibration or mechanical shock appear to be very low, since the crystalline structure of tin whiskers makes it strong in the axial direction [52]. In Okada's study [75], no whiskers (up to the length of 85 μ m) were observed to break, deform, or fall, under the vibration test⁴ [76] used in avionics sector and the drop test condition⁵ for the mobile phones [77]. Furthermore, the current practice of limiting forced air-cooling and closely packing the boards also reduces the likelihood of moving air breaking off the whiskers. Electrical shorts can either be permanent or intermittent, depending on the current carrying capability of the whiskers and the applied current.

Catastrophic failures have been reported when a whisker fuses open with a current of more than a few amps and a supply voltage over twelve volts in a vacuum or low-pressure environment [43]. In such conditions, the vaporized tin may initiate a plasma discharge, which can carry currents over 200 amps and may continue until all available exposed tin is consumed or the supply current is interrupted ([44], [74]).

³ Density of white tin is 7.31g/cm³, volume of whisker is 6.28×10^{-7}

⁴ Conditions for the vibration test: Frequency range of 10-2000Hz, Maximum acceleration of 20G, Maximum amplitude of 3.0mm, 1 octave/minute, two directions, 10 cycles [76]

⁵ Drop test condition: Maximum acceleration of 3000G, Acted time of 0.3msec., 6 directions, each 3 times [77].

Broken whiskers can also be a source of contamination. For example, they may interfere with the operation of micro-electro-mechanical structures (MEMS) or contaminate optical surfaces [44].

2.2.2 Failure Experiences

Particularly in the late 1980s and early 1990s, field failures have been reported in a variety of electronic applications, ranging from consumer electronics to space-based systems [78] (Table 4). Whisker-related failures were often experienced in the tin-plated electronic parts, including electromagnetic relays, transistors, hybrid microcircuit packages, terminal lugs, and ceramic chip capacitors [46].

Table 4: Examples of field failures attributed to tin whiskers

Application	Failure site	Reported year/reference
Spacecraft control processor of commercial satellite (Commercial)	Tin-plated latching relay	1998/[79]
Galaxy IV satellite (Commercial)	Tin-plated latching relay	1998/[80]
Electric Power Utility	Microcircuit leads	2002/[81]
Heart pacemakers (Medical)	Crystal can	1986/[31]
Missile program 'D' (Military)	Terminals	2000/[81]
Telecom equipment (Telecom)	RF enclosure	2003/[81]

Despite numerous field failure experiences, identifying tin whiskers as a cause of system failures is difficult, since whisker could vaporize when it shorts out. Moreover, field returns of inexpensive commercial electronics unlikely to have a detailed investigation on the root cause of the failure.

2.3 Risk Assessment and Management

The uncertainties associated with tin whisker formation makes quantification of the failure risks, presented by the use of pure tin and tin-rich lead-free alloys, problematic. In order to limit the whisker-related risks in the electronic products, some electronics manufacturers have proposed acceptance levels for whisker growth ([53], [82]). The threshold value for the whisker length at a prescribed time is generally specified as a criterion for an acceptable and whisker-free finish, in conjunction with required test conditions and duration. However, these acceptance level criteria are not sufficient enough to reflect the actual failure risks, induced by tin whiskers, since whisker length at the specified time (typically two years or less) is the only evaluated item. Further, it may be misleading if whiskers are missed at non-observed surface area with exposed tin.

To place a numerical value on the tin whisker risk, a metric has been proposed and is being used by some [83]. This risk assessment metric provides an application-specific risk of tin whisker failure, by assigning the weighted risk index for various influencing factors, including conductor spacing, substrate material, presence of an underlayer, plating type, plating thickness, and use of conformal coating type. While this risk metric is a useful guide for ranking a potential whisker risk, it could provide limited value in assessing and quantifying the actual failure risks. In summary, these measures fail to document the temporal nature of whisker formation and the variability in whisker growth.

The impact of failure on product safety and life cycle cost should be considered, when assessing the tin whiskers. For short life products, such as consumer products,

the limited data of maximum whisker length or no whisker greater than a prescribed length may be sufficient. However, for moderate life and long life products, more information about the growth, as discussed previously, is needed to quantify the risk. A tradeoff between the overall cost associated with mitigation methods and system level consequence of tin whisker related failures is necessary. In order to facilitate this tradeoff, JEDEC is developing⁶ a product class classification associated with whisker risk tolerance levels (Table 5).

Table 5: Product classes and levels of whisker risk tolerance [84]

Product class	System types	Tolerance level
Class 3	Mission/life critical applications such as military, aerospace and medical applications	Pure tin and high tin content alloys are not acceptable
Class 2	Business application such as telecom infrastructure equipment, high-end servers, etc.	Long product lifetimes and minimal downtime Products such as disk drive typically fall into this category Breaking off of a tin whisker is a concern
Class 1	Industrial products	Short product lifetimes No major concern with tin whiskers breaking off
Class 1A	Consumer products	Short product lifetimes No major concern with tin whiskers

As with most failure mechanisms, there is a desire to perform accelerated testing to quantify the failure risk. As one major objective (goal) of tin whisker studies, various industrial sponsored studies have focused on identifying environmental loading conditions that will precipitate whisker formation and growth in a

⁶ The standard document of JEDEC 201 [84], providing a general guideline for product classes and their risk tolerance level, has not passed the ballot as this time of writing.

controllable manner. Commonly explored loading conditions include coupled temperature and humidity ageing and temperature cycling. However, there remains no accepted accelerated test for whisker formation. Table 6 provides the examples of tin whisker testings, adopted by the electronics part manufacturers. To standardize testing and data collection, JEDEC, the standardization body of the Electronic Industries Alliance (EIA), recently issued a standard set of test methods for measuring whisker growth [29]. The standard JESD-22A-121, is based on more than two years of testing by participants in the iNEMI tin whisker users group [85]. It should be pointed out, however, that even JESD-22A-121 makes no claims as to its ability to assess whisker formation under field environments.

Table 6: Example of the suppliers' tin whisker testing

Supplier	Temperature/ humidity exposure	Temperature cycling	Ambient exposure
Integrated device technology	60°C/90%RH, 2000 hours	-55°C to 85°, 500 cycles	2000 hours
On semiconductor	85°C/85%RH, 500 hours	-35°C to 125°, 500 cycles	1200 hours
Lelon electronics	60°C/90%RH, 1000 hours	(-55 to -65)°C to (85 to 95°C), 500 cycles	1000 hours
Vishay	55°C/85%RH, 1680 hours	-55°C to 85°C, 500 cycles	None

2.4 Mitigation Strategies

As a result of the unpredictable nature of tin whisker formation and the inability to accurately quantify the failure risk, many electronics companies and industry-wide organizations have focused on establishing the effectiveness of mitigation strategies for tin whisker formation ([86]-[88]). From an equipment manufacturer's

perspective, mitigation strategies for reducing the risk of tin whisker failure fall into two categories: Part Selection Strategies and Assembly Process Strategies. A breakdown of several proposed strategies follows:

Part selection strategies:

- Avoiding pure tin and tin-rich lead-free finished parts
- Selecting matte or low-stress tin as the finish material
- Selecting parts with a nickel or silver underlayer
- Selecting annealed parts

Assembly process strategies:

- Solder dipping tin finished parts
- Minimizing compressive loads on the plated surface
- Applying a conformal coating

2.4.1 Part Selection Strategies

Completely avoiding pure tin and tin-rich lead-free finished parts should be preferred for high-demand, high reliability applications. In fact, a number of military and NASA's procurement specifications for electrical and electronic parts started to prohibit the use of whisker-prone materials [44]. Instead, many specifications, including military standard MIL-PRF-49467 for ceramic capacitors [89], specify the requirement of a minimum inclusion of 3% lead content. However, as previously mentioned, the use of pure tin and tin-rich lead-free finished parts may be unavoidable. For those going the avoidance route, vigilance over the in-coming parts is needed. Otherwise, the pure tin and tin-rich lead-free finished parts may accidentally be included in the end product ([90], [91]).

While it is widely claimed that matte tin finishes are less prone to long whisker growth, compared to bright tin finishes [70], matte tin should by no means be

considered as whisker-free. The chief difference between matte and bright tin lies in the grain size (1~5 μm for matte tin [18]) and the additives used in the plating process. Not only the grain size but also the thickness of plating is another parameter to consider. iNEMI Tin Whisker Users Group has recommended in 2005 [18] that the thickness of tin-plating for components without a nickel or silver underlayer should be 10 μm nominal (8 μm minimum preferred) to reduce the propensity for tin whisker growth and/or a greater incubation time.

Annealing has been investigated as a method for reducing whisker growth, since the application of high temperature relieves internal stress and possibly change grain size. With respect to annealing of tin plating deposit, the possible benefits include reduction of the compressive stress within a deposit, increase in grain size, release of hydrogen entrapped during the electroplating process and formation of uniform Cu_6Sn_5 intermetallics, possibly by introducing Cu_3Sn intermetallics between Cu_6Sn_5 and copper to act as a diffusion layer [64]. Annealing also seems to succeed in delaying the onset of whisker formation.

2.4.2 Assembly Process Strategies

Bridging the fence between part selection and assembly process is the application of solder dipping. There have been some discussions of making acquisition of solder-dipped tin-based lead-free components from the distribution supply chain [92]. The solder dipping was first discussed as a possible risk mitigation strategy by Arnold [42]. By covering the exposed tin-finished surface with conventional tin-lead material, the susceptibility to tin whisker formation can be greatly reduced. However, complete coverage with the dipping material is essential to achieve this goal. If

complete coverage does not occur, then failure may still occur. Furthermore, the possible collateral reliability issues, introduced as a result of additional solder dipping process, should be evaluated. The examples of identified reliability issues include package cracking or loss of hermeticity due to thermal shock, popcorning of plastic packages, solder bridging between leads on fine-pitch packages, and electrostatic discharge.

With regards to assembly or handling, care should be taken so as not to introduce any unnecessary mechanical loads and surface damages to tin-finished surfaces. As discussed earlier, surface damage and imperfections, including scratches and nicks, were often observed to have a higher propensity for whisker formation. This higher growth is most likely due to localized stress that acts as a nucleation point for whisker formation. In addition to internally developed compressive stress (e.g., due to tin-copper intermetallics), an externally applied compressive stress favors tin whisker formation.

Conformal coating has been proposed as a means to confine whisker growth and prevent whiskers from shorting exposed conductors. For example, a NASA study with Uralane coating showed a reduction in whisker growth rate [93]. However, tin whiskers were observed to penetrate the conformal coating (e.g., Silicone, Acrylic) with a thickness of up to 1.5 mils [94]. As such, the ability to provide sufficient coverage over all exposed tin-finished surfaces raises questions as to the protection afforded by conformal coats, and reworkability may make conformal coating less attractive.

2.5 Effects of the Selected Parameters

2.5.1 Type of Pure Tin Plating and Substrates

Although all pure tin finishes have the potential for whisker growth, matte tin finish is widely claimed to be less prone to long whisker growth, compared to bright tin finishes [70]. This difference mainly stems from the larger grain size and lower-stress of matte tin plating deposits. Additives in bright tin, including brighteners, grain refiners, and carbon, are believed to cause internal stress, which may lead to whisker formation. Exact amount and type of such additives are often proprietary matter for the commercial electroplaters.

Matte and bright tin finish are characterized by different grain size and carbon content. Matte tin has a larger grain size of 1-5 μ m with a smaller amount of carbon content of 0.005-0.05 % [18]. Excessive amounts of co-deposited carbon generally cause a loss of solderability in tin and tin alloy plating, excessive intermetallic formation, excessive oxidation and surface contaminants [95]. The effectiveness of matte tin reducing whisker growth may also be strongly influenced by the plating process, such as electrolyte. For instance, Schetty [71] showed that tin deposition from methane sulfuric acid (MSA) exhibited compressive stress that increased with time and could enhance whisker growth. On the other hand, tin deposits from non-MSA displayed tensile stress. Careful selection of the plating process and chemistries can reduce residual stresses and maintain the tensile strength of the tin deposits over time. However, the so-called 'whisker-free' proprietary plating techniques and chemistries advertised by plating chemical suppliers are still considered with skepticism by the electronics industry [18].

In this study, both bright and matte tin finishes were selected, due to the high preference of matte tin finish in the current electronic component market and the available data on whisker growths on bright tin in historical reports. The existing literature rarely assesses whisker growth between bright and matt tin over different types of substrate, which are subjected to different exposure conditions. This study, discussed further in the later section, implies a wide variation in tin whisker behavior between these two platings.

The effect of substrate on tin whisker growth has also been explored, since it is widely agreed that major contributors to the compressive stress including IMC formation and CTE mismatches are strongly depending on the type of substrate material (or underlayer material) and exposure conditions (e.g., [96]-[99]). For example, Whitlaw [96] examined twenty-two different tin finishes over brass, copper, and Alloy-42 substrates. His results indicated that the use of nickel underlayer was effective in reducing whisker formation on brass substrate. Similar effect was observed in Zhang's study [99]. Dittes [73] studied the effect of temperature cycling on tin whisker formation for tin plating over Alloy-42, since the coefficient of thermal expansion mismatch between Alloy-42 and tin is larger than that between tin and copper. It was observed that tin whisker formation on Alloy-42 increased with the number of applied temperature cycles. On the other hand, no discernable whiskers were observed on copper-based samples under thermal cycling condition. Despite various studies focusing on the effect of substrate on whisker growth, the effect of high temperature exposures (e.g., annealing) in retardation of whiskers growth has not yet been studied for different types of substrates and exposure conditions. Since the

source of compressive stress may be more than one, the mitigation strategies for tin whiskers should be evaluated for each type of substrate material.

2.5.2 High Temperature Exposures

Thermal treatments can often induce a change in the atomic and microstructure of a material in the solid state, mainly due to dislocation movement, a change in solubility of atoms, and/or a change in grain size. Annealing treats a metal or alloy by heating to a pre-determined temperature (not above its melting point) for a time sufficient to allow the necessary changes to occur, followed by relatively slow (at pre-determined rate) cooling. In general, the annealing process can soften a cold-worked structure by recrystallizing or inducing grain growth, soften certain age-hardenable alloys by dissolving the second phase and cooling rapidly enough to obtain a supersaturated solution, or relieve an internal stress. The temperature and duration of the annealing process depends on the characteristics of the material and the purpose of annealing.

With respect to tin plating deposit, the possible benefits of annealing include reduction of the compressive stress within a deposit, increase in grain size, release of hydrogen entrapped during the electroplating process and formation of uniform Cu_6Sn_5 intermetallics, possibly by introducing Cu_3Sn intermetallics between Cu_6Sn_5 and copper to act as a diffusion layer [64].

Annealing was historically adopted in the 1960s as a tin whisker mitigation practice [86]. For instance, in 1962, Glazunova [100] noted that annealing at 150°C significantly increased an incubation time and decreased tin whisker growth of tin-

plating on steel substrate. Other studies of annealing showed similar effects ([101]-[103]). Lee [67] showed that the application of annealing for one hour at 150°C changed the structure of the tin deposit from a compressive stress (approximately 10MPa), shifted to a tensile stress⁷. However, it was not documented if the tensile stress was maintained or resulted in retarding tin whisker formation. Furthermore, Britton [70] showed that there was no beneficial effect on reducing or eliminating whiskers due to same annealing process (150°C/one hour) for tin over copper specimens. iNEMI Tin Whisker-User's group also stated that the available data on annealing is still insufficient to provide this technique as an effective tin whisker mitigation strategy [18].

The optimal application timing for annealing process has yet to be established. Philips, Infineon, and STMicroelectronics have suggested that annealing is only effective if it is applied immediately after components are plated [64]. IBM indicated that matte pure tin over copper, which was annealed at 150°C for one hour within two weeks (24 hours preferred) of plating (where the lead pitch <1mm), could be adopted as one of their acceptable pure tin parts for its server and storage system [104]. The literature relating to the effect of annealing rarely assesses whisker lengths and density achieved after the annealing process.

The solder reflow process has been discussed as a possible whisker mitigator ([60], [75]). Although parts may be reflowed more than once in the assembly process, the peak temperature remains for only minutes. Since a peak temperature of lead-free reflow (up to 260°C, which is 40~50°C higher than conventional tin-lead

⁷ Data on stress level was measured using x-ray diffraction and reported only for 30 days after annealing.

reflow) is higher than melting point of pure tin (232°C), the microstructure of tin could be changed. Studies on the effect of reflow operations are somewhat contradicting. For instance, Cunningham [39] indicated that the effectiveness of reflow on reducing whisker growth depends on the mechanical stress conditions. The higher temperature during reflow process was shown to change the grain size of tin into regular polygonized grains, which induced less intermetallic growth, resulting in less internal stress within the tin deposit [105]. Su's study [106] focused on 260°C reflow, and also found that reflowing can retard whisker formation based on maximum whisker length observations after temperature cycling (-55~85°C) and 60°C/95%RH application. It was also observed that the variation in whisker length among leads was larger than among packages. On the other hand, it has been reported that reflow may not provide a complete mitigation for tin whisker formation [107].

2.5.3 Bending

Applied mechanical bending is one possible source of compressive stress, hypothesized to accelerate tin whisker formation ([65], [66]), although whiskers were observed to grow on a tensile region of the tin plating. In the case of electronic leaded packages, the trim and form process are applied after lead finishing and will cause mechanical bending. These bent portions of the electronic packages will have exposed (tin-) finishes even after board assembly. Furthermore, additional bending can arise due to thermal and power cycling of the assembly in operation. Thus, it is practical to evaluate the effect of bending stress on whisker formation.

Xu, et al, ([60], [65]) reported that externally applied tensile stress reduced the whisker growth, as far as an internally developed compressive stress does not exceed the level of tensile stress. Another study by Lal, et al, [54] showed that mechanically applied extrinsic stress after electroplating has much stronger influence on whisker formation, although the externally applied stress may not be evenly distributed over the plating of concern.

2.5.4 Electrical Current

There exists limited study of the effect of electrical current on the growth of tin whiskers. Some electronic component suppliers, including Texas Instruments (TI) and Alcatel, have adopted 5-V bias as part of tin whisker test conditions. TI incorporated tin whisker testing, consisting of pre-conditioning (-40 to 55°C, 24 hours), electrical bias (5V), temperature/humidity exposure [108]. TI's test results with the use of assembled tin-plated IC showed a consistent growth of tin whiskers on electrically biased samples. On the other hand, other studies including one by Arnold [42], Brusse [43], Osenbach [109], and Hilty [110], observed no significant influence of voltage bias on the formation of tin whiskers. For example, in Osenbach's study [109], an electrical bias of 3.3 V and 5 V was not observed to negatively affect propensity of whisker growth on 15µm thick tin-plated leadframes, which were subjected to 60°C/93%RH condition, after annealing at 150°C for one hour. The usage of Ni underlayer was also shown to be effective in retarding whisker growth, regardless of electrical bias.

There are only two studies on the role of electrical current on tin whisker growth. Hilty [110] conducted experiments on matte tin plated brass using four different

levels of current density (0.25×10^2 to 3.12×10^2 A/cm²) under three exposure conditions. He concluded that both electrical voltage bias and current flow do not affect whisker growth or its orientation. Liu, et al, [111] conducted an accelerated electromigration test on tin whiskers using Blech structure of 5000Å (=0.5μm) pure tin over 700Å titanium. In this study, whisker growth was observed at the anode end, while tin-grain depletion increased at the cathode end with current stressing time and temperature. It was concluded that whisker growth in order to release a compressive stress, generated by tin-atom movements from cathode to anode due to electromigration. The growth rate of tin whiskers was reported as 3Å and 7.7Å/second at room temperature and 50°C respectively in the presence of current density of 1.5×10^5 A/cm². However, the examined level of current density of (1.5×10^5 or 7.5×10^4 A/cm²), tin-plating thickness, application method, and base material are not representative of real electronic component applications. Table 7 compares the Liu's and Hilty's experiments with the present experiment in terms of various factors, such as type of plating, type of substrate material, and test duration. Observations of current experiment are presented in Chapter 4.

Table 7: Comparison of Three Experiments

	Liu's study [111]	Hilty's study [110]	My experiment
Type of tin plating	Not reported	Matte tin (no underlayer)	Matte and bright tin (no underlayer)
Thickness (tin)	0.5μm	3μm (one side)	5μm
Plating method	Vapor deposition	Electroplating	Electroplating
Substrate method	Ti/SiO ₂ /Si-wafer	Brass	Copper
Current density (A/cm ²)	1.5×10^5 , 7.5×10^4	25, 156, 208, 312	48
Test condition	Room ambient, 50°C	Room ambient, T/H: 52°C/90%RH, TC: -55°C to 85°C	T/H: 50°C/50%RH

Test duration	Up to 280 hours	1000 hours (42 days)	Up to 5760 hours
Measured items	Volume of voids, whiskers	Whisker density, maximum whisker lengths	Whisker density, maximum whisker length, length distribution
Sample size	Not reported	1 sample per current density	3 samples per test condition
Major observations	Whisker growths at anode end, while depletion of tin grains at cathode end. Higher current density or higher temperature induced longer whisker	The electrical fields, both bias and current flow, do not significantly affect whisker growth	Whisker growths were observed both at anode and cathode ends. Reduction in whisker density in the presence of electrical current

This study examines whisker growth under the application of electrical current on matte tin plated copper, which represents the most widely used material combination for the electronic component. The effectiveness of annealing was also investigated in response to the electrical current flow. Since actual electronic systems experience some levels of electrical current flow in the field, it is necessary to assess the effectiveness of mitigation strategies, including annealing, for whisker growth under the electrical current stressing. Experiment was conducted to assess the propensity of tin whisker growth on both annealed and non-annealed samples in this study, with the current stressing at $0.48 \times 10^2 \text{ A/cm}^2$ for an extended period of time up to 8 months.

Chapter 3. Approach: Overview of Experiments

In order to investigate the propensity of tin whisker growth, a set of experiments was conducted using matte and bright tin platings on metal coupons. The plated coupons were subjected to high temperature exposures, including annealing (150°C/one hour). Whisker growth on tin-plated samples was characterized using environmental scanning electron microscopy (ESEM), in terms of the maximum whisker length, length distribution, and whisker density, at different time periods up to 24 months in the case of experiment-1 and up to 8 months for the experiment-2.

3.1 Experimental Procedure: Experiment-1

Two types of pure tin platings, matte and bright tin, were commercially electroplated with an average thickness of 200 micro inches (= 5 μ m), over base materials of copper (Olin 194⁸), brass (type 260⁹) and Alloy-42 (Fe-42Ni). Test samples were 25.4 x 25.4 x 1.56 mm in dimension. Copper and Alloy-42 substrates were chosen as representative substrate material for the surface mount as well as through-hole devices. Since ASTM¹⁰-B 545 [112] specifies 5 μ m as the minimum thickness of coating required facilitating the soldering of electrical components (class B), the plating thickness of 5 μ m was selected in this experiment. In general, 5-12 μ m thick tin-plating is typically used for the outer termination of the chip resistors [113].

Tin electroplating was applied by a commercial process. Reported parameters for the sulfuric acid based tin electroplating process included a range of current

⁸ Composition of Olin 194: Cu-2.4Fe-0.03P-0.1Zn (wt%)

⁹ Composition of type 260 brass: 69-71Cu, 0.05Pb, 0.05Fe, 0.2 Ni, 0.015 P, (wt%) and remainder Zn

¹⁰ ASTM: American Society for Testing and Materials

density (5-20mA/cm²) and a plating bath temperature of 60-70°C. Matte and bright tin were created based on organic additives. Sulfuric acid was added for bright tin plating.

Ion chromatography was used to examine the contamination level of plating, based on ICP-TM 605 method 2.3.28, with a standard eluent (1.7mM sodium bicarbonate/1.8mM sodium carbonate) [114]¹¹. Ion chromatography showed no significant contamination of methane sulfuric acid, which can be created by the plating solution and process. The detected contamination levels were: chloride 0.37µg/in², bromide 0.865µg/in², nitrite 0.72µg/in², and sulphate 0.493µg/in². In every case, the concentration level was below the recommended minimum level, such as 1.0µg/in² of chloride [115]. In addition to cleanliness analysis, the surfaces of the samples were examined under ESEM prior to any exposures. Except for a few scratches, neither nodules nor whiskers were observed.

The tin plated specimens were divided into four groups for high temperature exposures: one for control, one for annealing, and the remaining for two simulated reflow processes, where simulated means without actual solder or flux to a board (Figure 7). All of the selected heat treatments were applied one week after electroplating. The reflow temperature profiles included an eutectic tin-lead solder profile (melting point of 183°C, peak reflow temperature of 220°C) and a lead-free solder profile (melting point of 217°C, peak reflow temperature of 260°C) (Figure 8). A 150°C (= 0.83 T_m, T_m: melting temperature) for one hour annealing condition was

¹¹ As per IPC-TM650, samples were placed into clean heat-sealable polyester film and immersed into a mixture of isopropanol (75% by volume) and deionized water (25% by volume), followed by heating up the bag up to 80°C for one hour [114].

selected as representative of conditions used by electronics manufacturers ([64], [67], [70], [100], [104]). The annealed samples were then cooled down at room ambient.

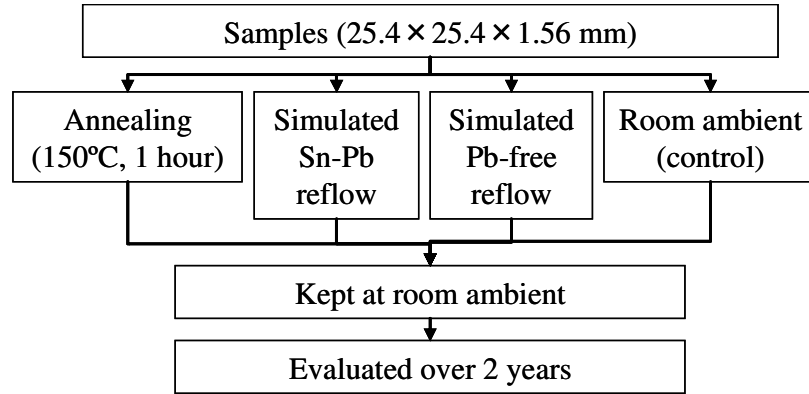

Figure 7: Test flow chart

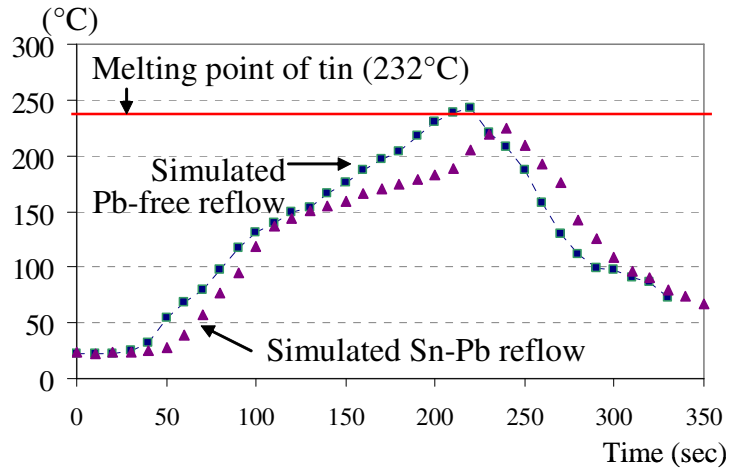

Figure 8: Selected reflow profile

3.2 Experimental Procedure: Experiment-2

Copper metal coupons (12.7 x 31.7 x 0.15 mm in dimension, Olin 194) were commercially electroplated with matte and bright tin, with a measured average

thickness of $5\mu\text{m}$ ($\pm 0.4\mu\text{m}$). The selected electrolyte was the same as the one used in experiment-1. To simulate the trim and form process and bending which can arise from lead being in use, the plated samples were bent approximately 90 degree at both ends over a plastic fixture (Figure 9).

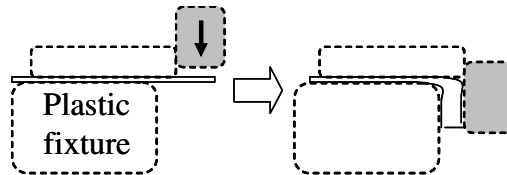

Figure 9: Bending method

A constant electrical current was then applied to half of the annealed and half of the non-annealed samples. A 10-V power supply was attached to a set of tin-plated copper samples, which were connected in parallel, coupled with a $10\ \Omega$ resistor (Figure 10). Based on measured voltage and resistance across each tin-plated sample, the current density was found to be $0.48 \times 10^2 \text{A/cm}^2$. This is in line with current density of power electronics, such as power converters for wireless network access and microprocessor powered applications [116]. Three samples per test condition were then placed in a temperature/humidity chamber at $50^\circ\text{C}/50\%\text{RH}$ for 8 months. This exposure condition was chosen to accelerate the whisker formation, based on studies, which reported the higher whisker propensity at these conditions ([44], [94], [117]).

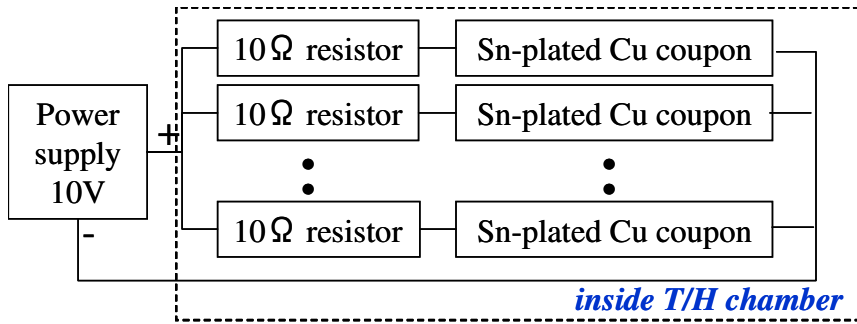

Figure 10: Circuit diagram

For each sample, surface observations were conducted at three observation sites, the flat, inner-curved, and outer-curved area, as shown in Figure 11.

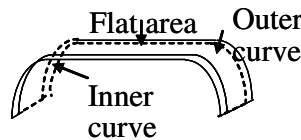

Figure 11: Observation sites

3.3 Adopted Inspection Methods

This section explains inspection methods, adopted in the course of experiment-I and experiment-2. Surface observation was first attempted using optical microscopy, followed by ESEM in order to count and characterize the whisker growth. Due to various orientations of whiskers and the possible presence of other inclusions at the surface, it was found that it is not recommendable to identify the whiskers only using optical microscopy. ESEM was used for surface observation throughout the environment, coupled with energy dispersive spectroscopy (EDS) for elemental analysis.

As expected, different shapes of whiskers were observed to grow on the tin-plated surface in this experiment. JEDEC has defined whiskers as a spontaneous columnar or cylindrical filament, usually of mono-crystalline metal, emanating from the surface of a finish [29]. However, since whisker-related risks vary depending on the shapes and sizes of the growth, a more clear differentiation of growth characteristics may be necessary for a proper evaluation of tin whisker propensity and associated risks. Since any shapes of whiskers of a certain length can cause an electrical short, the maximum length of whiskers is a factor, regardless of shape. In this work, all types of growth will be referred as whiskers, unless otherwise specified. The practical limit for the minimum whisker length was approximately $2\mu\text{m}$ in this experiment.

Surface observation consisted of two steps. First of all, an entire surface of concern was scanned to identify the longest whisker and obtain the representative sites under ESEM with lower magnification (approximately x200-x400). Identified longest whisker was further inspected using a higher magnification (up to x20,000) to facilitate the length measurement. In some cases, the stage (of the ESEM) was tilted to some angle for optimum observation. Based on surface observations of fifteen randomly selected sites from an entire surface, the lengths of whiskers were recorded for distributional analysis.

The axial length of whisker, measured from the electroplated surface to the whisker tip, was recorded as a whisker length in this experiment [29]. For bent whiskers, the total axial length was estimated by adding all of the straight subdivisions of a whisker. For instance, the axial length of whisker, shown in Figure 12,

was recorded as $(A+B+C)$ μm . Since this study focuses on the length of tin extrusions, various shapes and types of whiskers were not generally noted.

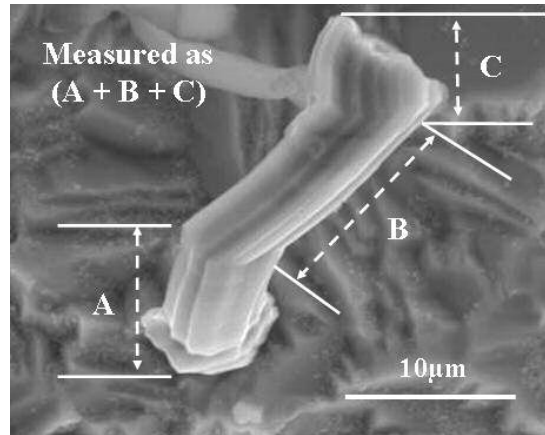

Figure 12: Total axial length of whisker

Whisker density can be defined as the number of whiskers per unit area. In this study, fifteen areas of $725 \times 615 \mu\text{m}$ (approximately $\times 360$ under ESEM, total area of 6.7mm^2) were randomly chosen as fixed observation points. Whisker density was calculated as an average number of whiskers per total inspected area.

3.3.1 Sample Method and Verification

In order to verify our sampling technique, a number of sites (one site: $725 \mu\text{m} \times 625 \mu\text{m}$) were first selected along the diagonal of the square sample and ESEM observations were conducted with the same magnification. Figure 13 shows the number of whiskers observed at each inspection. The changes in average number of whiskers per site were examined (i.e., moving average), while increasing the number of inspected sites. Since data converged after ten measurements, fifteen sites from

each sample were randomly selected from an entire surface to obtain a representative value for the sample (Figure 14).

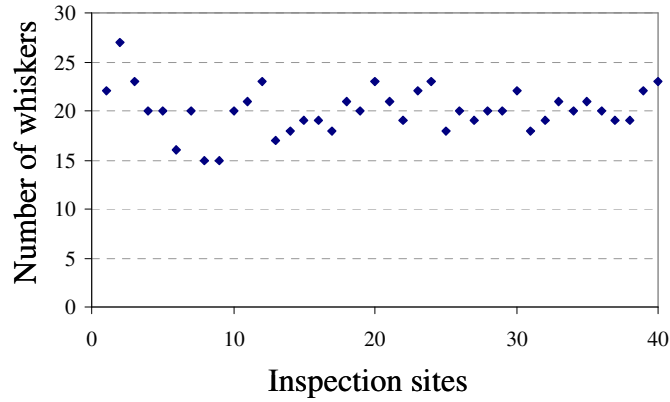

Figure 13: Number of whiskers observed at each inspection

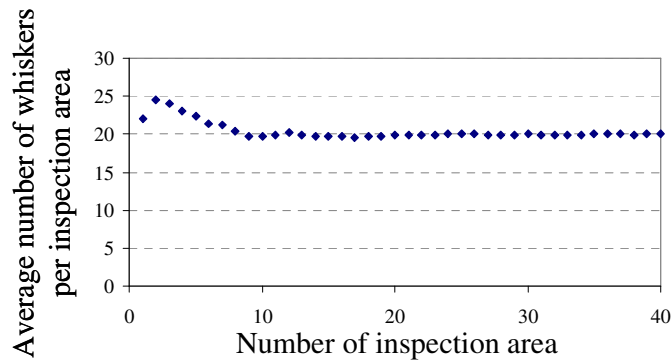

Figure 14: Average number of whisker growth, with increase in inspection sites

3.3.2 Data Analysis of Whisker Length and Whisker Density

To date, the growth of whiskers is typically measured only at the specified time and characterized in terms of the maximum (observed) whisker length and the categorization of density (i.e., high, medium, and low), based on inspection of the limited area of tin-plated surface of concern. This current industry practice in whisker measurement implies a limitation in identifying the actual maximum whisker

length and growth rate of whiskers. A longer whisker (than maximum observed whisker) could be present at the non-observed surface area. Since the same whisker may not necessarily be identified as the ‘maximum observed whisker’ at different observation periods, the growth rate of whisker cannot be obtained.

The only way of being certain about the exact percentage of whiskers with a certain length on the surface is to accurately count every whisker growths and calculate the percentage. However, this is too time and resource-intensive to be a viable option, so a way of estimating the percentage of whiskers in a certain length on the surface is necessary. To do this end, the underlying distribution of a measurement data set was assessed using statistical procedures, such as Kolmogorov-Smirnov (K-S) and Anderson-Darling (A-S) goodness of fit tests [118]. These K-S and A-S tests, based on cumulative distribution function, are superior in the case of small sample sizes, as compared to the Chi-square goodness of fit test [119]. The A-S test was specifically selected in order to test the goodness of fit at the tails of distribution. The fitting at the tails of distribution is of most importance in distributional analysis of whiskers, since it directly affects the estimated maximum length of whiskers, which has the highest potential of bridging between adjacent conductors.

For each test condition, measurement of whisker lengths was collected at fifteen sites, randomly selected from an entire surface of concern. Based on these sample data, it was hypothesized that the lognormal distribution is a specific distribution type (population), which the collected measurement data comes from. This hypothesis was made based on parametric analysis of distribution fitting. An example result for bright tin over brass is given in Table 8.

Table 8: Example of parametric analysis of distribution fitting

Distribution type	Modified K-S test	Average plotted value fit	Likelihood value	Weighted value	Rank (of best fit)
Exponential-1	99.99	23.87	-121.8	430	5
Exponential-2	27.58	5.65	-95.9	250	2
Normal	19.56	5.85	-101.0	280	3
Lognormal	0.083	3.28	-97.1	160	1

Distribution parameters, such as mean and standard deviation, were also estimated accordingly. In order to evaluate the hypothesis, the theoretical (i.e., based on hypothesized distribution type and parameters) and empirical step function of cumulative distributions were compared in terms of their closeness. The closeness can be evaluated using the test-statistics value and critical value, as provided in Table 9. The hypothesized type of distribution can be accepted when the test-statistics value is smaller than the critical value in each goodness-of-fit test.

Table 9: Test-statistics and critical values for the goodness-of-fit test ([118], [120])

Test type	Test-statistics value	Critical value
K-S test	$\max_{1 < i < n} \left F(Z_i) - \frac{i}{n} \right $	$\frac{1.36}{\sqrt{n}}$
A-D test	$A^2 = -n - \left(\frac{1}{n} \right) \sum_{i=1}^n (2i-1) [\ln(F[Z_i]) + \ln(1 - F[Z_{n+1-i}])]$	$\frac{0.725}{\left(1 + \frac{0.75}{n} + \frac{2.25}{n^2} \right)}$
Note	n= sample size, Z_i = i-th sorted sample value, F= standard normal cumulative distribution function. The listed test were applied to log-transformed original data, with a significance level (α)=0.05	

In every observation sites, acceptance criterion was satisfied. Furthermore, the hypothesis of lognormal distribution was accepted in all types of samples. The probability plot, given in Figure 15, facilitates graphical observation of the closeness between plotted points and the fitted distribution line, as a result of Anderson-Darling

test¹². The given P-value describes the probability of obtaining such results, when the hypothesized log-normality of the data is true [120].

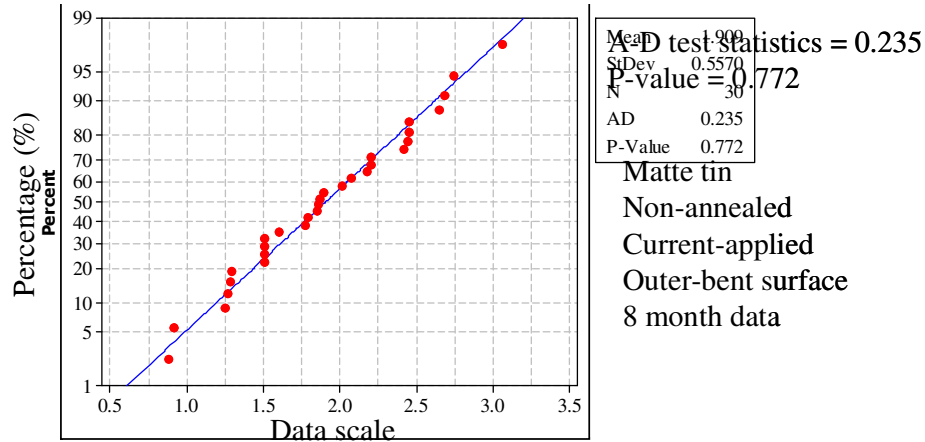

Figure 15: Example of A-D test result (probability plot)

The fitting of lognormal distribution to the measurement data on whisker length was further supported using one of the non-parametric methods, Kernel Gaussian estimate. Kernel Gaussian estimate, characterized by the equation¹³

$$\hat{f}_h(x) = \frac{1}{nh} \sum_{i=1}^n K\left(\frac{x_i - x}{h}\right),$$

is known as a better density estimator [121] and can be used to

check whether parametric methods have results in over-fitting or over-smoothing the data. As shown in Figure 16, lognormal distribution appears to be the best fit to the whisker length data, by using the non-parametric method. As a result of this distribution fitting, it was determined to characterize the whisker growth by parameters of a fitted distribution, such as mean whisker length, and 99-percentile

¹² Anderson-Darling test was performed using Minitab® statistical analysis software package.

¹³ x_1, \dots, x_n , n: independent observations

value. The maximum whisker length was defined as the 99-percentile value of the fitted lognormal distribution.

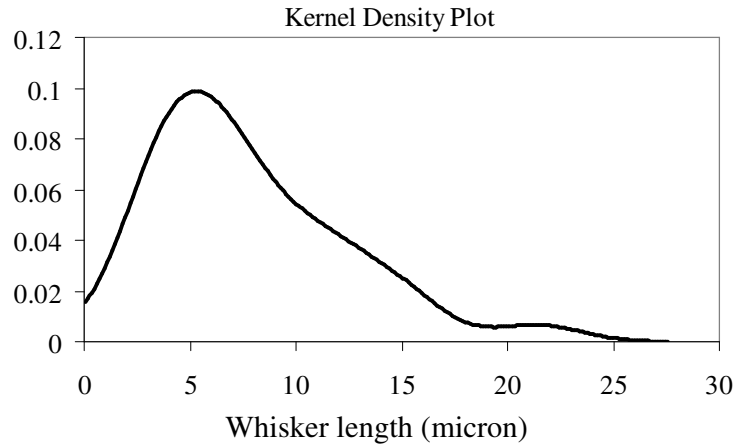

Figure 16: Kernel density plot

Whisker density can be determined as the number of whiskers per unit area. The number of whiskers was first counted at randomly selected fifteen observation sites (one site: $725 \times 625 \mu\text{m}$) from the entire surface of concern for each sample (similar as experiment-1). Each data set consisted of fifteen measurement data per sample, three samples per test condition. In order to enable analyzing the data statistically, a single factor analysis of variance (ANOVA) was conducted. ANOVA can answer the questions whether data collected from three samples can be treated as one set of data (i.e., 45 measurements/condition). In this ANOVA analysis, F-statistics value provides a measure to compare the amount of variance between groups (treated differently) to the amount of variance within groups (treated the same). Detailed procedure for a single factor of analysis of variance is explained in Appendix A.

With an alpha level of 0.05, all results from ANOVA were found to satisfy the criterion of [(F-obtained value) < (F-critical value)], which is required to support the null hypothesis. The null hypothesis was defined as that the mean whisker density of each group is the same. Table 10 and 11 provide the examples of result from ANOVA, which resulted in accepting the null hypothesis. This example is based on density measurement, taken at the flat surface of annealed-bright tin samples, with no current applied.

Table 10: Example of inputs to ANOVA

Sample	Number of measurement	Average	Variance
Sample 1	15	21	28.28
Sample 2	15	17	20
Sample 3	15	19	31.85

Table 11: Example results from ANOVA

	Degree of freedom	Mean square	F-obtained	P-value	F-critical	Results
Between the group	2	60	2.245	0.118	3.219	Accepted (2.245<3.219)
Within the group	42	26.714	N/A			
Total	44	N/A				

These ANOVA results enabled to treat forty-five measurements as one set of data per condition. Whisker density, D, was calculated as follows:

$$D = \left(\sum_{i=1}^3 \sum_{j=1}^{15} N_{ij} \right) / 20.1 ,$$

where i is the sample size, j is the observation site, N_{ij} is the number of observed whiskers, 20.1 is the total observed surface area (mm^2)

All sets of whisker density data, when 45 measurements consisted of a set, were found to be best fitted by a lognormal distribution. Levene test [122] was used to evaluate the change in the variances of the observations, due to the selected condition. Observation results of experiment-2, presented in the Chapter 4, are all based on Levene's test with a significance level of 0.01, unless otherwise specified.

Chapter 4. Observations and Discussions

Observations presented in this chapter are based on ESEM observations taken over 24 months of room ambient storage, after the selected high temperature exposures (experiment-1) and 8 months of 50°C/50%RH temperature/humidity exposure.

4.1 Bright Tin versus Matte Tin

Historical reports have primarily focused on whisker growths on bright in plating. In fact, electronics industry has a previous experience of using bright tin in 1970's, until when soldering issues after burn-in were raised [95]. iNEMI provides classification of bright and matte tin finishes as shown in Table 12 [18]. Bright tin with smaller grain size is often claimed to be more prone to tin whiskers than mate tin with larger grain size, due to higher internal stress.

Table 12: Definition of bright tin and matte tin finishes

	Bright tin	Matte tin
Grain size (μm)	0.5-0.8	1-5
Carbon content (%)	0.2-0.8	0.005-0.05

Grain size of each type of pure tin plating (as-received samples) was first confirmed to be an average of 4.6 μm for matte tin and 0.9 μm for bright tin, as per iNEMI's definition (Figure 17). Similarly, as-received samples for experiment-2, which included the annealed samples, were examined in terms of their grain sizes under ESEM. The grain size of each type was observed to be within the iNEMI

specification for bright and matte tin (Table 13). The columnar shaped grains were observed in the case of matte tin plating.

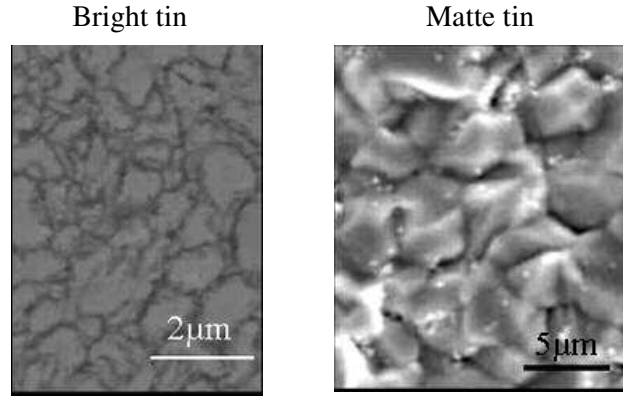

Figure 17: Grain size of pure tin finish (experiment-1)

Table 13: Comparison of grain size(experiment -2)

		Measured grain size
Bright tin	Annealed	0.56
	Non-annealed	0.58
Matte tin	Annealed	3.03
	Non-annealed	4.35

Another major difference in whisker growth on matte and bright tin surface is a presence of depletion of tin surface. Figure 18 shows a depletion of tin surface at the base of whisker on the bright tin surface. This depletion is believed to indicate tin atom diffusion, which may also explain how tin atoms are added to whiskers in an orderly manner [61]. On the contrary, no clear depletion could be observed at the base of whisker on matte tin plated samples (Figure 19). The surface of bright tin was found to be more flat than that of matte tin, as far as the electroplating chemistry in this experiment is considered. In addition, a majority of whiskers on matte tin initiated from one original grain, and maintained its shape and size of the grain during

growth. On the other hand, whisker growths on bright-tin plated surface was independent from the grain structure (i.e., whiskers did not initiate from one grain).

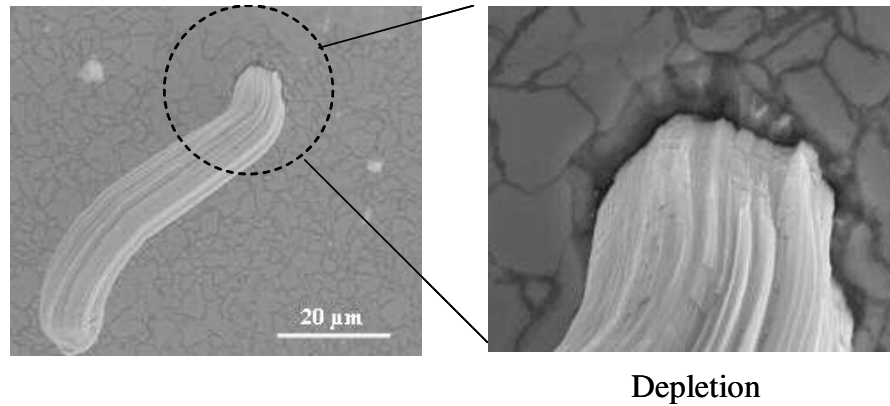

Figure 18: Whisker growth and depletion of tin surface on bright tin

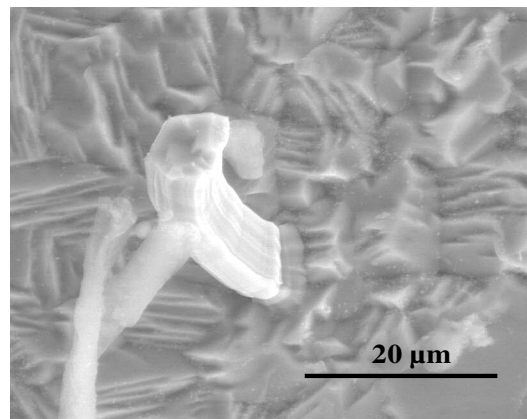

Figure 19: Whisker growth on matte tin

Whisker growth was observed in every type and exposure conditions, and the length increased with time. However, the rate of increase varied significantly among the different types of samples. The longest whisker of all samples was 200μm,

observed on the bright tin plated brass sample. Needle-like whisker, shown in Figure 20, grew from nodule-type eruption. This implies that a difference in the interfacial energy may play a role in inducing whisker formation. Nodule-type eruption underneath a whisker has higher surface energy due to its complex top surface. In order to minimize this surface free energy, needle-like whisker can emanate from the nodule-structure. Compressive stress, a major suspected driving factor, is also directly related to atoms having high potential energy.

The interfacial energy can also be changed by grain structure of the deposit. For instance, a plating layer with a smaller grain size has a larger number of grain boundaries, which results in having a higher potential energy. In this study, isothermal annealing at 150°C was observed to result in coarsening of microstructure of the deposit overtime, but no discernable change in grain size/structure of the surface morphology. As described earlier, columnar type whiskers on matte tin plated samples are highly dependent on the grain size of the surface. This could be the reason why the effect of annealing on whisker growth on matte tin has not been clearly identified, as compared to the case of bright tin.

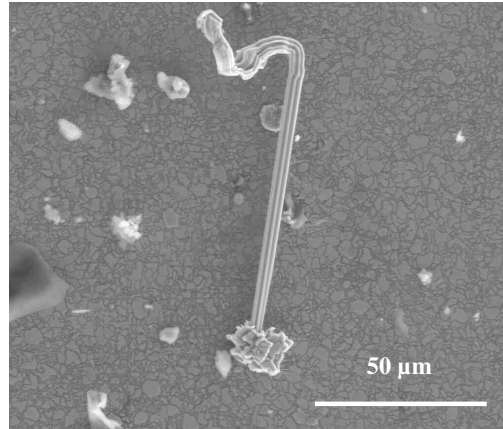

Figure 20: Needle-like whiskers

Figure 21 provides a relative whisker length comparison between bright and matte tin finishes with respect to different substrate materials (data is normalized based on the longest observed whisker, namely whisker on bright tin over brass). The data is based on measurement on non-annealed samples, at 18 months of room ambient exposure. It was observed that bright tin does not necessarily induce the longer whisker growth, as compared to matte tin.

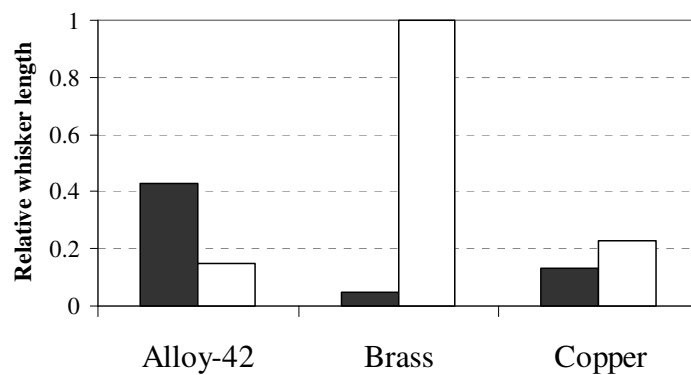

Figure 21: Whisker length comparison with respect to substrate material

The effect of selected exposure conditions (e.g., annealing) on whisker length is shown in Figure 22. Similar as previous plot, data is normalized based on the longest observed whisker, in other words, whisker on bright tin over brass in this case. For the samples with Alloy-42 substrate, annealing provided reduction in whisker length. However, annealing induced longer whiskers on matte tin plated brass samples. Given the same substrate material, the effect of selected exposure condition on whisker length may differ between bright and matte tin.

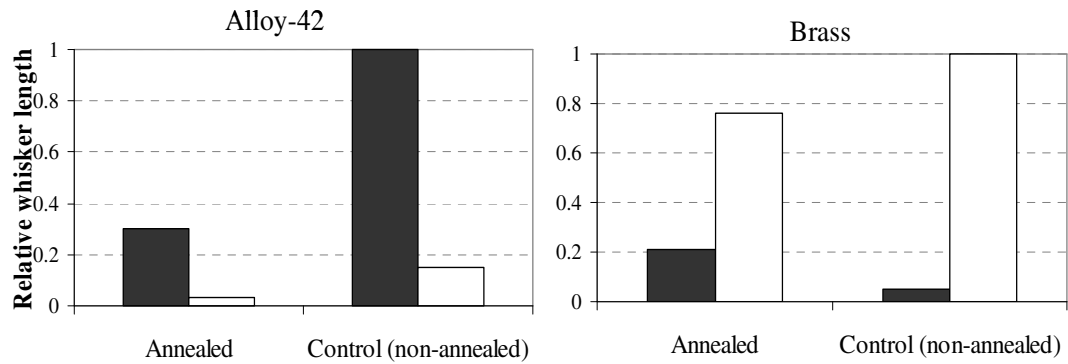

Figure 22: Whisker length comparison with respect to annealing

With regards to whisker density, the trend in change of whisker density with time varied between bright and matte tin especially in the case of samples with copper substrate (Figure 23). Whisker growth behavior (in terms of length and density) of bright and matte tin differs depending on the substrate materials and exposure conditions.

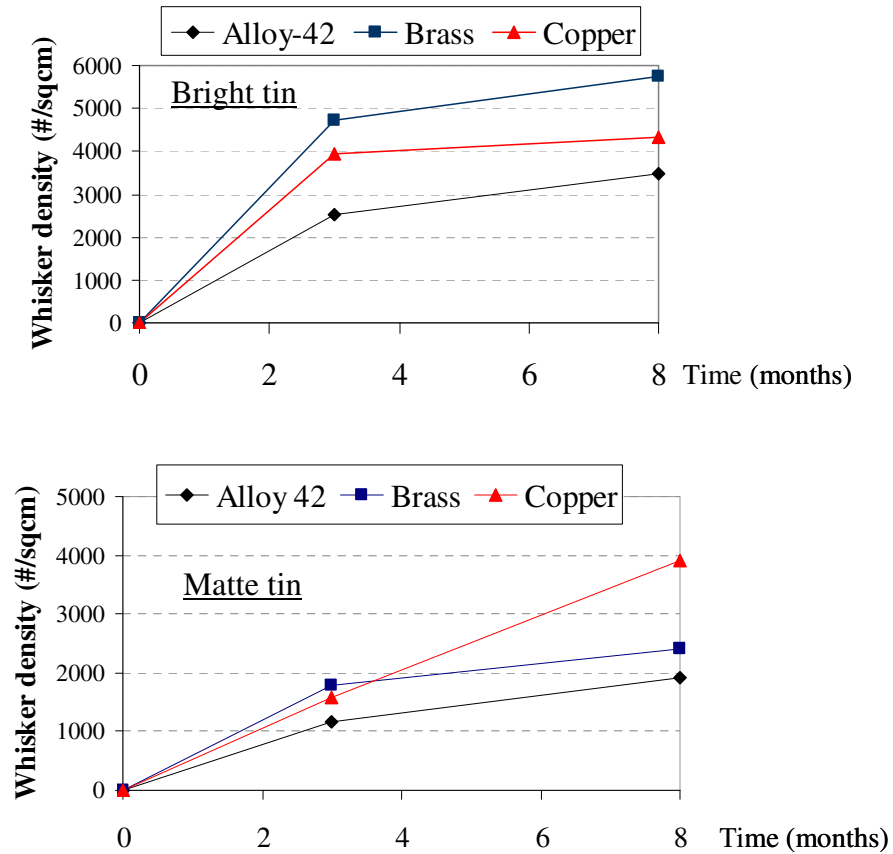

Figure 23: Change in whisker density with time (bright and matte tin)

However, the highest whisker density and longest whiskers were observed on bright tin over brass. Regardless of the selected high temperature exposures, this combination generated twice as long whiskers as all other types of specimens, including one whisker measured to be 200 μm . Thus, bright tin over brass can be used as a worst-case scenario for risk assessment of tin whisker formation.

4.2 Saturation in Whisker Density

Tin whisker growth was observed on all specimens, within three months at room ambient storage after selected high temperature exposures in this experiment.

Saturation in whisker density was further assessed for tin whiskers using the density of whiskers. Whisker growth was considered to be saturated, when the measured whisker density value becomes stabilized and no new whisker will initiate.

Figure 24 presents changes in whisker density on matte tin over copper, with time up to 24 months of room ambient exposure. The least number of whiskers were observed on annealed sample at 3 months observation. However, at 8 months after high temperature exposures, almost the same number of whisker growth was identified on every type of matte tin over copper samples (i.e., regardless of selected high temperature exposures). In other words, the rate of change in whisker density can differ with time and in response to selected high temperature exposures. In fact, annealed samples achieved the highest change rate in whisker density between 3-8 months, as compared to samples, subjected to other selected exposures. Whisker density was observed to saturate, since there observed only a slight change in whisker density after 8 months, and increase rate continued to slow down afterwards. Due to the different change rate in whisker density, it is misleading to characterize the whisker growth before saturation in whisker density. Further, the test duration of any qualification test or whisker characterization method should exceed the saturation of whisker growth.

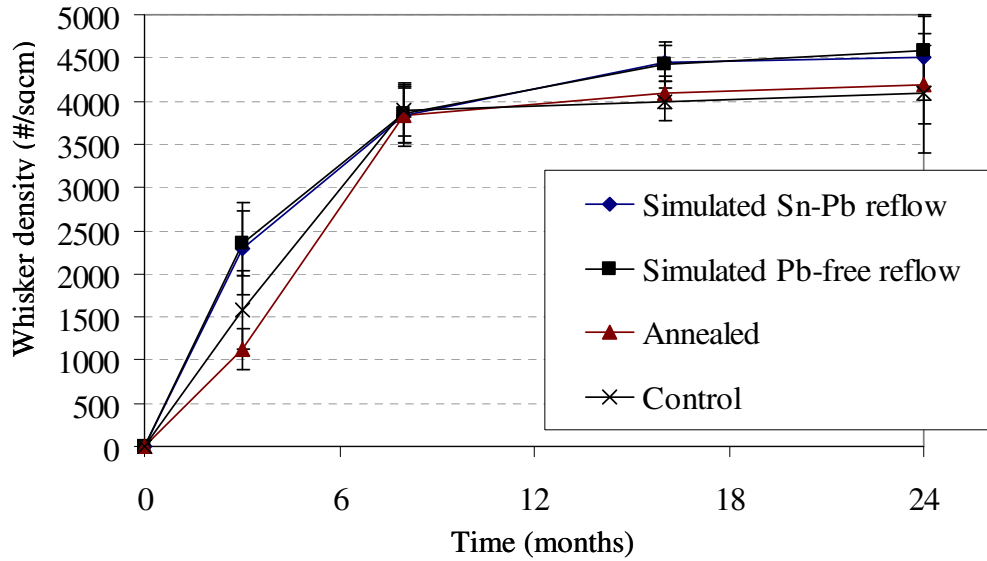

Figure 24: Saturation in whisker density (matte tin over copper)

4.3 Effect of High Temperature Exposures

Figure 25 illustrates a relative whisker length comparison observed on mate tin. Based on the maximum length of whiskers at 18 months observation, the conventional tin-lead simulated reflow temperature exposure generated longer whiskers than the lead-free reflow temperature profile in every case. The peak temperature involved in the simulated lead-free reflow temperature exposure, which is higher than melting point of tin (232°C), may have played a role in mitigating the tin whisker growth.

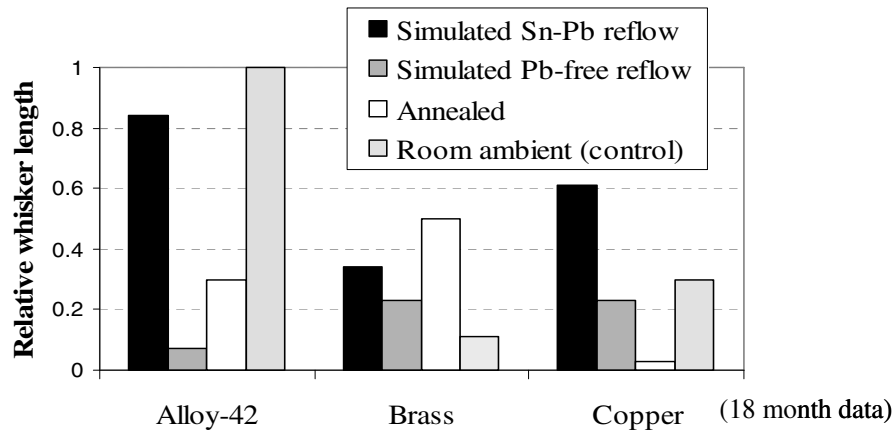

Figure 25: Relative comparison of whisker length on matte tin

The effect of high temperature exposures varied widely among the different substrate materials. This could be due to the different source of compressive stress, which contributed to whisker growth. For instance, in the case of tin over copper sample, tin-copper intermetallic formation is suspected to be the major source of compressive stress under the long-term room ambient storage. Applied annealing could be beneficial to reduce irregular shaped intermetallics, resulting in reduced compressive stress generation. On the other hand, with respect to Alloy-42 samples, containing nickel, the CTE mismatch between tin deposit and Alloy-42 is the primary source of compressive stress. The CTE mismatch will not be removed by an annealing process. Accordingly, test methods and mitigation strategies for tin whiskers should incorporate the factor of substrate material (i.e., source of compressive stress).

Annealing was observed to be effective in reducing the maximum length of whiskers for matte tin over copper samples, compared to other selected high

temperature exposures. Since annealing process generated more whiskers in the category of 25-40 μ m, as compared to other samples, distributional analysis was further performed. The length distribution data was found to provide a best fit to a lognormal probability density function (the goodness of fit value was at least 0.98). As shown in Figure 26 and Figure 27, distribution data on whisker length can be used to characterize the growth of tin whiskers, coupled with the maximum observed whisker length. Change in mean whisker length (obtained as an average change per month) continuously decreased in both non-annealed and annealed samples (Table 14), while increasing the standard deviation at 24 months observation period in the case of non-annealed samples. For the matte tin plated copper samples, annealing provided 79% reduction in estimated growth rate, which was based on change in mean whisker length. Furthermore, after two years of room ambient storage, 72% reduction in maximum whisker length was achieved by the application of annealing at 150°C/one hour.

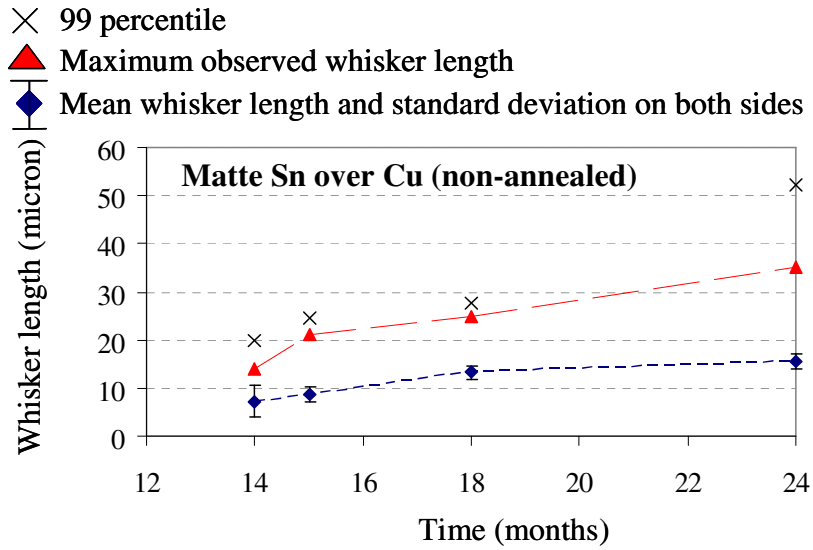

Figure 26: Change in whisker length (non-annealed, matte tin over copper)

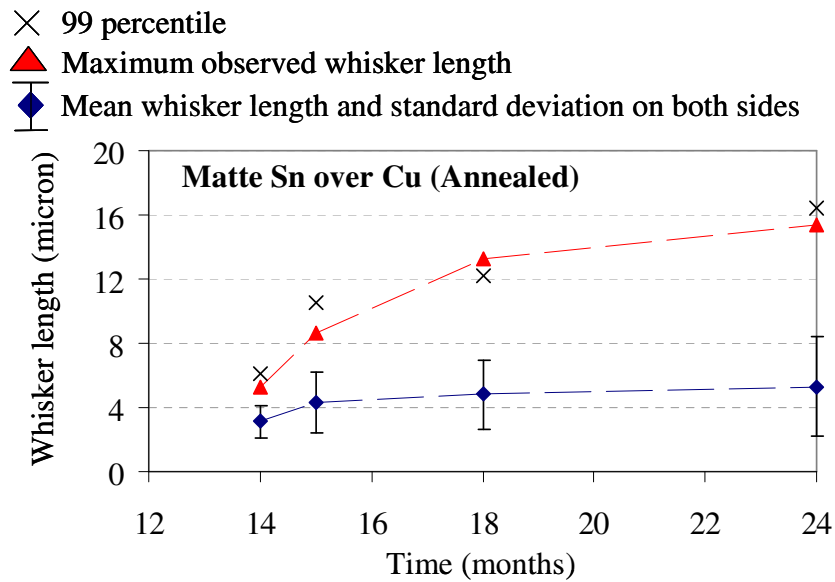

Figure 27: Change in whisker length (annealed, matte tin over copper)

Table 14: Change in mean whisker length on matte tin over copper

Duration (months)	Change in mean whisker length (μm)		Estimated growth rate ($\mu\text{m}/\text{month}$)	
	Non-annealed	Annealed	Non-annealed	Annealed
14-15	1.57	1.17	1.57	1.17

15-18	1.50	0.49	0.5	0.16
18-24	2.28	0.48	0.38	0.08

Annealing, however, did not reduce whisker length for matte tin samples, having the brass substrate (Figure 25). Brass contains alloying quantities of copper and zinc. The Energy Dispersive Analysis (EDS) of the surface of matte tin over brass showed the presence of zinc at the surface (Figure 28). This implies that zinc atoms diffuse into the tin film and migrate to the surface. The zinc atom, which reached at the outermost surface, can bind with oxygen and generate the zinc oxide. It has been discussed that volume change associated with the formation of oxide layer can result in generating a compressive stress within the tin layer. Such compressive stress can further contribute to the growth of whiskers. Since the zinc oxide is known to form faster than tin oxide [123], this could be the reason why whiskers grew more on samples with brass substrate, compared to copper-based samples. It appears to be that annealing could not remove the source of compressive stress, resulted from the oxide-layer formation.

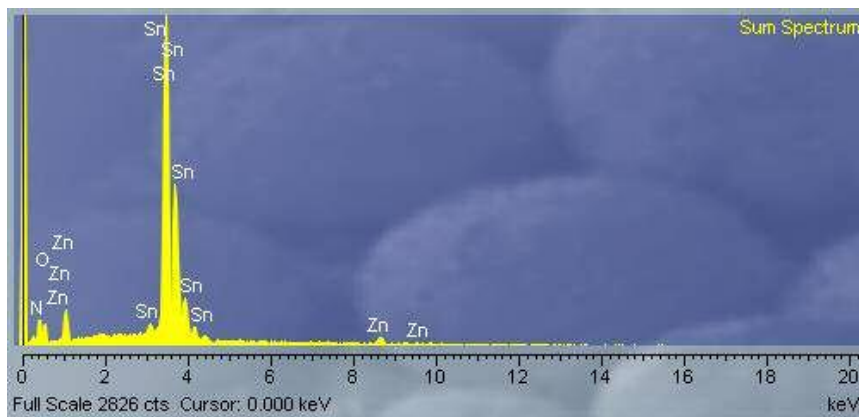

Figure 28: EDS analysis for matte tin over brass sample

4.4 Effect of Electrical Current

Whisker growths were observed in all types of samples, with the longest whisker of 66.7 μm after 8 months under 50°C/50% RH temperature/humidity exposures. Whisker growths were observed to initiate approximately after 3-5 weeks of electroplating, based on weekly surface observation up to 11 weeks. In the absence of electrical current, initiation of whisker growth at the bend area was about 2 weeks shorter, compared to those at the flat surface area.

Contrary to Liu's study [111], whisker growth was observed at both the anode and cathode ends of the tin plated samples. Figure 29 shows examples of whiskers at each end. Further, no discernable voids or depletion of tin grains at the cathode end, under ESEM observation were observed. This could be due to much lower level of current density, adopted in this experiment, as compared to Liu's experiment focused on electromigration phenomenon with the current density of 1.5×10^5 or 7.5×10^4 A/cm².

Observed whiskers mainly have striations along the outer surface, regardless of application of electrical current. Surface cracks and imperfections, induced by bending procedure, were observed at the outer-bent surface. These surface discontinuities could be a path for the whiskers to initiate, since the built-up compressive stress can be released through such discontinuities. However, whisker did not necessarily grow at these surface discontinuity spots in this study.

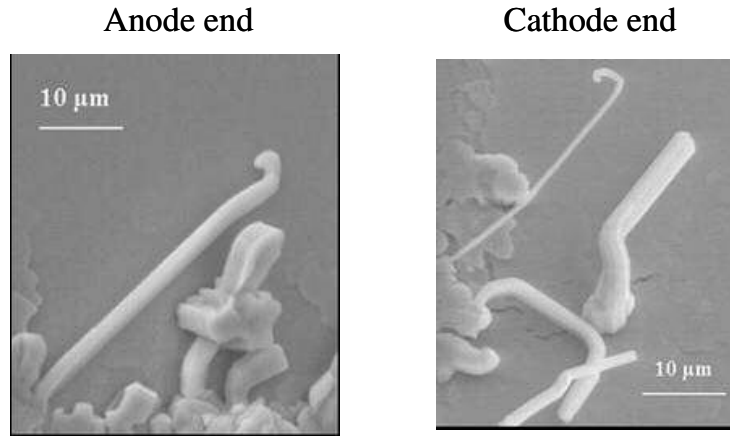

Figure 29: Whisker growths on bright tin in the presence of electrical current

4.4.1 Whisker Density

Figure 30 and 31 show the comparison of whisker density observed at 8 months. This graph shows the mean whisker density with one standard deviation on both sides, observed at the flat area. Compared to the control samples (i.e., non-annealed and no current applied), annealing, application of electrical current, and a combination of electrical current and annealing, resulted in a significantly lower whisker density both on matte and bright tin. The same effect was observed at the bend areas, in addition to the flat surface areas. Bright tin always induced more whiskers than matte tin.

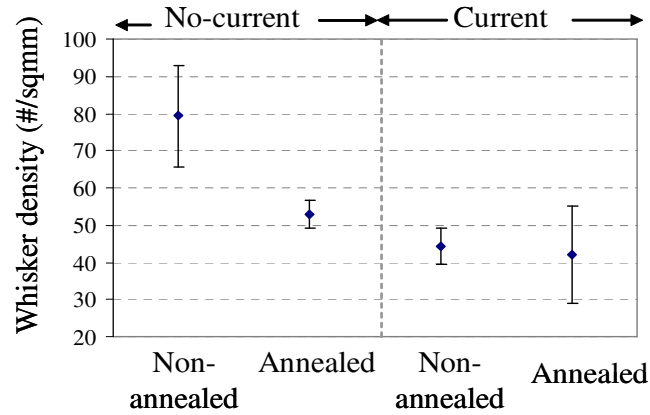

Figure 30: Whisker density comparison for bright tin

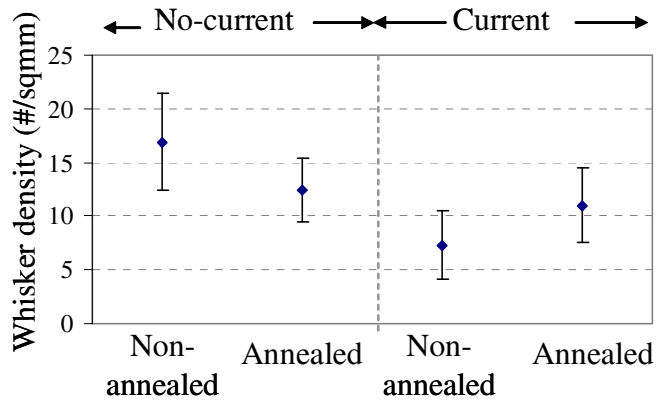

Figure 31: Whisker density comparison for matte tin

4.4.2 Whisker Length

For each test condition, the observed maximum whisker length as well as the estimated maximum whisker length with one standard error on both sides were determined. The maximum whisker length was defined as the 99 percentile value of the fitted lognormal distribution. A standard error, SE, was obtained as $SE = SD / \sqrt{n}$, where SD is a standard deviation and n is the number of measurement. It was also

found that the application of electrical current increased the estimated maximum whisker length at the flat surface of bright and matte tin.

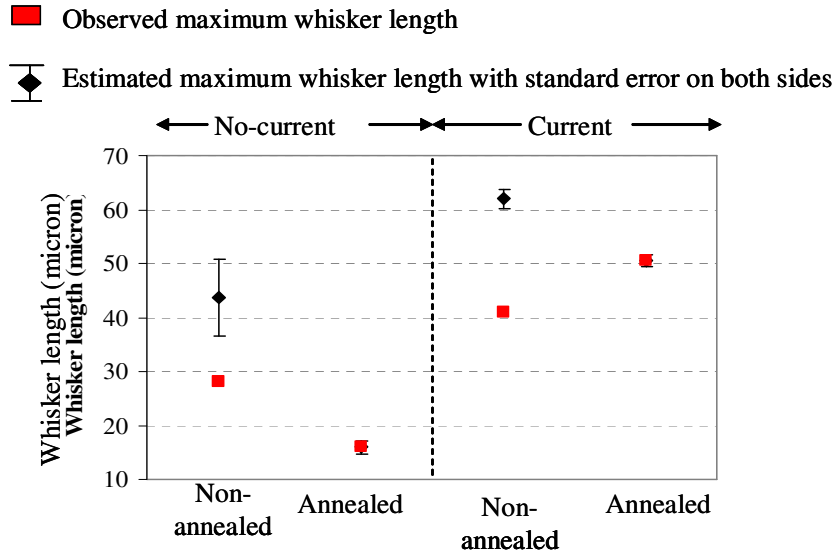

Figure 32: Whisker length comparison for bright tin

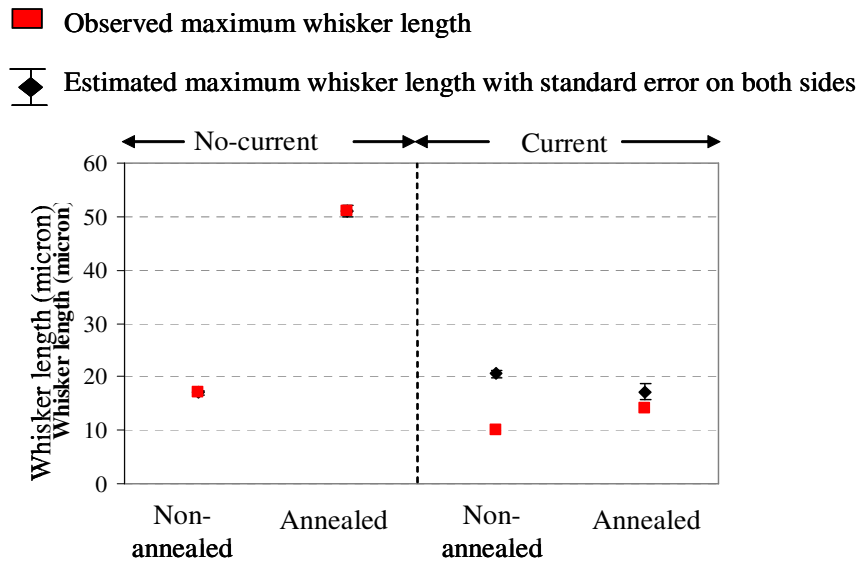

Figure 33: Whisker length comparison for matte tin

With respect to bright tin, in the absence of electrical current, annealing at 150°C/one hour reduced the whisker length, as compared to non-annealed samples (under 50°C/50%RH exposure condition). As described earlier, such effect of annealing on retarding the whisker growth has been discussed since 1960s [86] and some electronics manufacturers ([67], [70], [86]) have adopted condition of 150°C for one-hour in their practices. The recognized benefits of annealing include: reduction of the compressive stress within a deposit, increase in grain size, release of hydrogen entrapped during the electroplating process and formation of uniform Cu_6Sn_5 intermetallics, possibly by introducing Cu_3Sn intermetallics between Cu_6Sn_5 and copper to act as a diffusion layer [64]. However, as stated earlier, the effect of electrical current was observed to have a stronger influence on the length of whiskers, compared to the application of annealing.

On matte tin-plated copper samples, which were subjected to 50°C/50%RH for up to 8 months, annealing (at 150°C/one hour) did not reduce the whisker length in the presence or absence of electrical current (Figure 33). However, at 2 months observation period, annealed samples provided shorter whisker growths than those of the non-annealed samples (Figure 34). This result suggests that relying on the whisker growth characteristics observed within short test duration (such as 3000-4000 hours, proposed in the test standard) could be misleading when evaluating the effectiveness of whisker growth mitigation strategies.

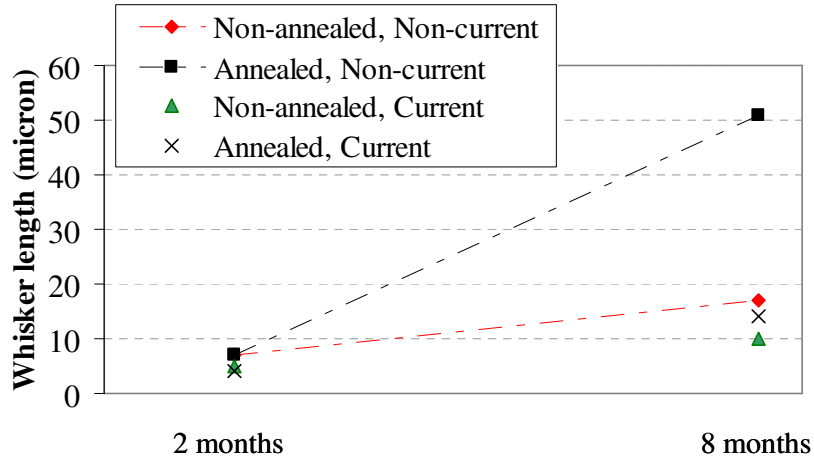

Figure 34: Effect of annealing on whisker length on matte tin

For the non-annealed samples (both bright and matte tin) in the absence of electrical current, whiskers tended to be longer at the inner-curved area, compared to the flat surface area (Figure 35, Figure 36). This is expected because the applied mechanical bending can cause compressive stress at the inner-curved surfaces ([65], [66]). However, whiskers were also observed to grow on the tensile (outer-curved surface) region of the tin-plating at a reduced density and length.

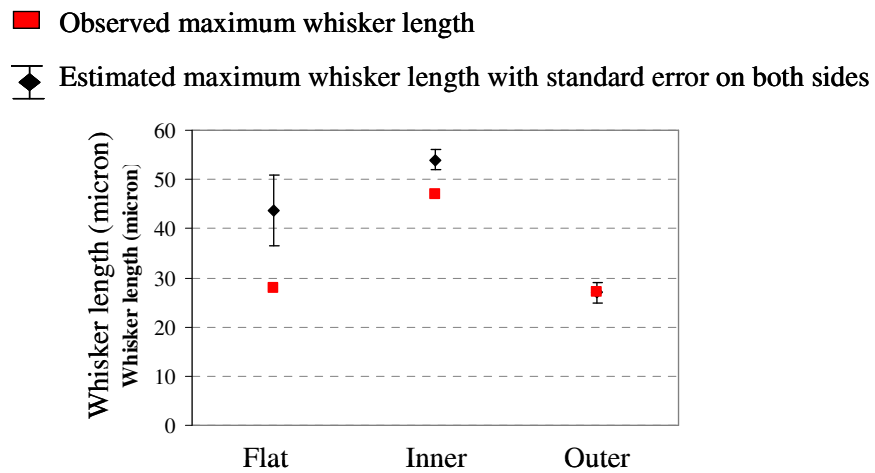

Figure 35: Comparison of whisker length due to bending (bright tin)

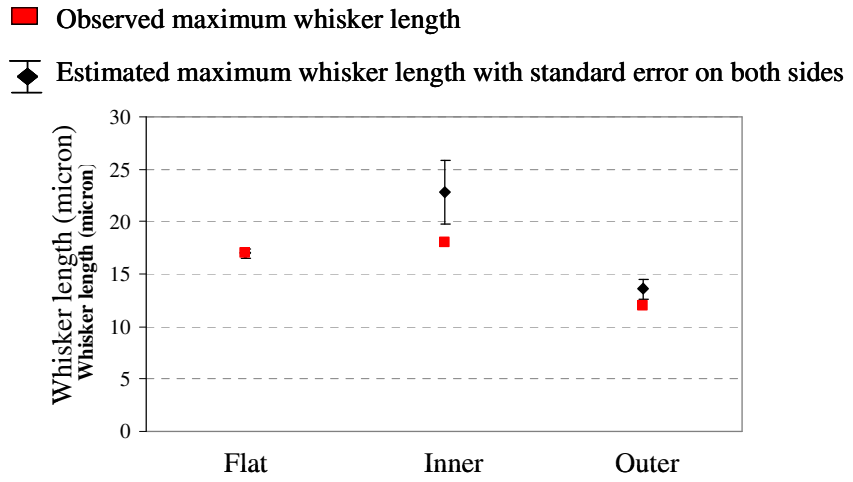

Figure 36: Comparison of whisker length due to bending (matte tin)

Chapter 5. Conclusions

Tin whisker formation poses a reliability risk in electronic systems, which are used, for extended periods of time. Due to a continued increase in the selection of tin-rich component finishes, a high likelihood of having an electronic product containing pure tin or tin-rich component finishes is expected. Especially, the low-volume electronics industry segment (e.g., military and space) has limited control over the part selection, neither driving nor resisting the transition to lead-free electronics.

Due to a lack of acceleration factors for whisker growth, the effective mitigation strategies are necessary and should be evaluated when high reliability and safety are critical. The existing whisker characterization method, relying on the maximum observed whisker length at the specified time, tends to fail in characterizing and capturing the temporal nature of whisker growth. The maximum observed whisker length is necessary, but not a sufficient means to characterize the growth of tin whiskers and further evaluate the effectiveness of possible mitigation strategies for tin whisker.

In this study, whisker growth on various types of samples was examined in terms of its maximum whisker length, length distribution, and whisker density and distribution analysis of whisker length was used.

The experimental results showed the different behaviors of whisker growth (e.g., length and density) between bright tin and matte tin finishes, depending on the substrate materials and exposure conditions. It was concluded that bright tin should

not be used simply as a representative or comparison of matte tin for characterizing tin whisker growth. However, bright tin over brass was found to be used as a worst-case scenario for risk assessment of tin whisker formation.

For the matte tin over copper specimens, saturation in whisker density (i.e., end of incubation period) was observed after approximately 8 months of room ambient storage. This result suggests that the currently recommended test duration (e.g., a minimum of 3000 hours in the JEDEC test standard [29]) could be insufficient to cover saturation of whisker growth. The test duration of any qualification test should exceed the saturation period. To capture a saturation in growth, the detailed number of whisker per given area should be measured, other than simply classifying the whisker density in ranges (e.g., classification of high, medium, and low density).

The effect of high temperature exposures of tin whisker formation was evaluated in terms of reduction in the maximum whisker length, whisker growth rate, and whisker density. Tin-lead simulated reflow temperature exposure was observed to generate the higher mean value (of lognormal distribution for the whisker length) and the longer whiskers, regardless of the substrate materials. In the case of matte tin over copper sample, annealing (150°C for one hour) provided 72% reduction in maximum whisker length, as compared to control (non-annealed) after two years of room ambient storage in this experiment. Time-based distribution data for whisker length was beneficial to characterize whisker growth.

It was also observed that annealing process did not always offer a positive effect on whisker formation. Annealing did not reduce whisker length for matte tin over brass. In the case of copper-based sample, annealing could form uniform

intermetallics, which can help releasing a compressive stress, developed by irregular tin-copper intermetallics at room ambient. Irregular tin-copper intermetallics are believed to be a major driving factor for whisker formation in the case of copper-based samples. However, annealing did not help reducing other possible source of compressive stress. Accordingly, it is critical to develop, evaluate, and adopt mitigation strategies for tin whisker formation, depending on the factors influencing compressive stress within the tin deposit under the given environmental conditions.

The role of electrical current of tin whisker formation was evaluated in terms of whisker density and whisker length under 50°C/50%RH temperature/humidity exposure. For both bright and matte tin, the application of electrical current significantly reduced the whisker density. Annealing at 150°C for a hour also resulted in lower whisker density, compared to the control sample (non-annealed, no current applied), with or without the electrical current stressing. This trend was observed in all observation sites.

On the other hand, the application of electrical current increased the maximum whisker length at the flat surface of bright and matte tin samples, subjected to 50°C/50%RH temperature/humidity condition for 8 months. In addition, the electrical current was observed to have much stronger influence of whisker formation, compared to annealing. In the case of bright tin, annealed samples generated much shorter length of whiskers than those on non-annealed sample, in the absence of electrical current. However, after application of electrical current, both annealed and non-annealed samples induced as long whiskers as that on control samples. On matte tin-plated copper samples, which were subjected to 50°C/50%RH for up to 8 months,

annealing (at 150°C/one hour) did not reduce the whisker length in the presence or absence of electrical current. Finally, as expected, whiskers tended to be longer at the inner-curved area, compared to the flat surface area for the non-annealed bright and matte tin samples in the absence of electrical current.

Chapter 6. Contributions

This dissertation work provides an experimental investigation on a method for characterizing whisker growth on surfaces electro-deposited with pure tin. Whiskers were inspected and characterized for an extended period of time, which rarely performed in industry.

The contributions of this work can be summarized:

- Experimentally demonstrated that bright tin over brass can be considered a worst-case scenario for a risk assessment for tin whisker growth
- Experimentally showed that the industry practice of testing for 3000 hours for monitoring the propensity of tin whiskers is insufficient to cover whisker growth saturation
 - Whisker density saturation was observed on matte tin plated copper after 8 months of room ambient storage
 - Maximum whisker length has increased throughout observation period of this study
- Experimentally demonstrated in a two year study that annealing can reduce maximum whisker length on matte tin plated copper in room ambient storage. However, annealing did not reduce whisker length for matte tin over brass.
- Experimentally showed that application of constant electrical current reduced the whisker density for bright and matte tin plated copper at 50°C/50%RH.

However, whisker length was observed to increase in the presence of electrical current

- For bright tin, application of electrical current has been observed to have stronger influence of whisker length, than annealing.

Appendices

Appendix A: A Single Factor Analysis of Variance (ANOVA)

This appendix A explains the procedure for a single factor Analysis of Variance. ANOVA was selected due to its ability to test the difference in means between groups. In all cases, null hypothesis, H_0 , was set as:

H_0 : The mean whisker density (or length) of each group is the same.

ANOVA test was conducted using a source of variance shown in Table 15 [122].

Table 15: Source of Variances, ANOVA

Source of variance	Sum of the square	Degree of freedom	Mean square	F-obtained
Between groups	SS_B	DF_B	MS_B	F_O
Within groups	SS_w	DF_w	MS_w	
Total	SS_T	DF_T		

Firstly, based on the sum of the squares, which is a measure of variability, are calculated as

$$SS_T = \sum x^2 - \frac{(\sum x_T)^2}{N}, \quad SS_B = \sum \frac{(\sum x)^2}{n} - \frac{(\sum x_T)^2}{N}, \quad SS_w = SS_T - SS_B$$

Degree of freedom is defined as follows:

$$\left\{ \begin{array}{l} DF_B = (\text{number of groups}) - 1, \\ DF_w = (\text{total number of measurement}) - (\text{number of groups}), \\ DF_T = (\text{total number of measurement}) - 1, \end{array} \right.$$

By using the values of SS and DF, the mean square is determined to characterize the average amount of variance per degree of freedom, as:

$$MS_B = \frac{SS_B}{DF_B}, MS_W = \frac{SS_W}{DF_W},$$

Last of all, the test statistics in ANOVA, the F-obtained value, is derived as:

$$F_O = \frac{MS_B}{MS_W},$$

The F-obtained value will be compared with F-critical value in order to determine whether the null hypothesis should be accepted or rejected. F-critical value can be found in F-table (provided in common statistics book), using the selected alpha level (i.e., P-value) and values of DF_B and DF_W . P-value is a measure of the likelihood of the observed value of the statistic under the null hypothesis. In this work, P-value of 0.05 was used in ANOVA. If [(F-obtained) < (F-critical)], then all groups can be regarded as the same. Namely, the null hypothesis is supported. Otherwise, the null hypothesis will be rejected.

Appendix B: Research on Tin Whiskers

Authors, year, reference	Reported items
Compton, Mendizza, and Arnold, 1951, [50]	Spontaneous growth of whisker was first reported on tin electroplating.
Herring and Galt, 1952, [124]	Whisker was inferred as a single crystal, based on mechanical properties of tin whiskers.
Peach, 1952, [125]	Dislocation mechanism for whisker growth was first proposed.
Koonce and Arnold, 1953, [33]	Whisker was reported to grow from the whisker base, based on electron microscopy micrographs.
Eshelby, 1953, [58]	Eshelby dislocation mechanism involved Frank-Reed dislocation sources emitting loops that expanded by climb to a boundary.
Frank, 1953, [59]	It was proposed that whisker grew from dislocations located at the whisker base operated through a diffusion-limited mechanism.
Koonce, 1954, [32]	Whisker was observed to form kinked.
Fisher, Darken, and Carroll, 1954, [35]	Whisker growth rate was first reported for tin-plated steel, under the application of pressure, up to 7,500 psi. Compressive stress was first discussed as the driving force for whisker growth.
Hisiguti, 1955, [45]	It was pointed out that growth rate reported by Fisher in 1954 could not be predicted based on thermodynamic approach
Franks, 1956, [37]	Dislocation glide mechanism, which depends on self-diffusion on tin, was first described.
Amelinckx, 1957, [126]	Helical dislocation model for whisker formation and growth was discussed.
Baker, 1957, [127]	Angular bends in whiskers for tin coatings were studied, but observations were not compatible with dislocation mechanism.
Glazunova, 1962, [100]	Whisker growth rate was observed through experiments for tin-coated brass and steel. However, there observed a large difference in growth rate between Fisher's data and his data.
Pitt and Hening, 1964, [55]	Decrease in whisker densities was observed due to increase in lead content in the clamp-pressure experiment.
Arnold, 1956, 59, 66, [42]	Mitigation strategies were first discussed. Strategies include <ul style="list-style-type: none"> - Alloying tin plating with lead - Use of fused and hot-dipped tin coatings - Use under low relative humidity and ambient temperature - Electric and magnetic fields

Authors, year, reference	Reported items
Ellis, Gibbons, and Treuting, 1958, [62]	Recrystallization was first discussed as a factor for the whisker formation.
Glazunova and Kudryavtsev, 1963, [128]	Various substrate materials (copper, nickel, zinc, brass, aluminum, silver, steel, and tin) were investigated. Whisker density and growth rates were reported to be high for 2-5 μ m thick tin plating over copper substrate. Heat treatment study (100-180°C, 1-24 hours) were first investigated and showed a significant reduction in whisker formation.
Britton and Clarke, 1964, [129]	It was observed that copper underlayer was effective to mitigate some whiskers on bright tin over brass, but less effective in the case of matte tin. No whiskers were observed for 28 months at room ambient and 50°C on bright tin over brass.
Ellis, 1966, [130]	Growth directions for spontaneously grown whiskers were reported to be small crystallographic indices, which were glide plane indices.
Furuta and Hamamura, 1969, [63]	Whisker growth rate was formulated as a function of the vacancy energy, independent of the film thickness. However, unusual sample preparation and alloy were pointed out.
Rozen, 1968, [101]	Mitigation strategies for tin whiskers on bright tin plating (stannate bath based) were proposed, including: Use of tin plating with minimum thickness of 5 μ m Bake after electroplating, at 191-218°C for 4 hours
Rozen, 1970, [131]	Metallographic cross-section of bright tin plated parts was first shown.
Key, 1970, [34]	Morphology of tin whiskers was observed to be similar as that of zinc and cadmium whiskers and not dependent on plating conditions and substrate material.
Keher, 1970, [36]	It was concluded that material transport in the direction normal to the substrate took place during whisker formation, but there was little diffusion in the plane of substrate.
Leidheiser, 1971, [132]	A review of whisker research up to 1970 was provided as a chapter in the book.
Jafri, 1972, [133]	Ultrasonic agitation of the electrolyte plating bath was proposed as an effective mitigation method for matte tin whisker growth.
Tu, 1973, [38]	Stress associated with Cu ₆ Sn ₅ intermetallics was first considered as a key-driving factor of whisker formation. The formations of Cu ₆ Sn ₅ at room temperature and the formation of Cu ₃ Sn at temperatures higher than 60°C were identified.

Authors, year, reference	Reported items
Britton, 1974, [70]	The recommendations for tin whisker mitigation were provided: <ul style="list-style-type: none"> - Use of nickel or copper underlayer for electrodeposited tin over brass - Avoidance of bright in plating directly over brass - Use of plating thicker than 8μm - Application of heat treatment at 180-200°C for one hour - Use of hot-dipped tin plating - Use of tin-lead deposits, containing more than 1% of lead
Lindborg, 1975, [134]	Internal stress within the deposited film was first measured by X-ray diffraction method. Whisker formation was reported to be related to the magnitude of internal stress, but did not appear to be associated with microscopic stress.
Dunn, 1975, 1976, [135], [136]	It was first reported that whisker has capacity of current carrying. It was recommended that tin, cadmium, and zinc should be excluded from the spacecraft design.
Lindborg, 1976, [137]	Two-stage dislocation model for the tin, cadmium, and zinc whiskers was proposed.
Zakraysek, 1977, [138]	The rate of whisker growth on the bright tin plated leadframe was observed as 1-20 μ m/hour.
Hada, 1978, [40]	Annealing at 140°C for 0.5-3 hours was observed to be effective for bright tin plated electromagnetic relays, when the plating thickness is thicker than 10 μ m or thinner than 2 μ m.
Tu, 1982, [139]	A linear growth rate of Cu ₆ Sn ₅ intermetallics was reported. It was also reported that the growth rate is slower in the case of thicker tin film.
Kakeshita, Fujiwara, 1982, [105]	It was surmised that whisker grows on recrystallized grains. It was also described that dislocation rings were more prevalent on fine-grained tin plating than on larger-grain tin plates.
Nordwell, 1986, [140]	Tin-whisker related failure on the 12-year old radar systems was reported.
Dunn, 1987, [69]	Mechanical and electrical characteristics of whiskers were presented. For instance, Young's modulus of whiskers were in the range of 8-85GPa, with a ultimate tensile strengths of 8 MPa. Whiskers with diameters of 3 μ m can carry a 32mA current without fusing.
Corbid, 1989, [141]	Fusing (reflowing) was not observed to prevent whisker formation and growth

Authors, year, reference	Reported items
Cunningham, Donahoe, 1990, [39]	Four types of samples, including pure tin, Sn-10Pb, Sn40Pb with and without reflowing, were subjected to mechanical stress at elevated temperature. It was concluded that Sn-40Pb with reflow would be an optimum process.
Selcuker, Johnson, 1990, [142]	A network of polygonized grains with distinct grain boundaries was revealed. Annealing at 150°C for at least 45 minutes in air was shown to double the average grain sizes up to 5-10µm.
Tu, 1994, [47]	Cracked oxide theory (A weak point and/or crack of oxide layer enables a localized relief of internal stresses by permitting whisker growth to emerge through this weak point) was first introduced. Model for whisker growth was proposed, including the growth rate characterized by stress level in the film, temperature, and whisker spacing.
Harris, 1994, [143]	Various mitigation strategies for tin whiskers were recommended. For example, addition of 1-2 % copper to a tin film may not be effective in reducing whisker growth.
Tu, 1996, [144]	The difference in layer structure of intermetallic formation was described in relation with tin whisker growth.
Lee, 1998, [67]	Direct measurement of residual stresses in tin electroplating was presented. Major findings include - Initial as-deposited stress in tensile (11 MPa) and disappears to zero quickly, but increases to a compressive stress (-8 MPa). - Annealed samples (at 150°C) had zero stress and remained stable over time. - Whisker grains were found to orient differently in comparison to the immediately surrounded as-plated tin grains.
Ewell, 1998, [145]	It was reported that whiskers may be effectively mitigated by using the nickel underlayer, applying heat treatments, or adding alloying elements for passive components.
Yanada, 1998, [146]	No discernable changes in surface morphology were observed between Sn-10Bi and Sn-5Ag finishes, after 3 months of storage at 50°C.
Schetty, 2000, [147]	Sn, Sn-Bi, Sn-Cu, and Sn-Pb plating on brass and copper with and without Ni underlayer were examined at 50°C for a minimum of 3 months. Major observations include: - The observed whiskers (25µm) on Sn-Bi (10µm-thick) were longer than those on pure Sn. Whiskers grown after aging at 50°C were scarce and short A nickel underlayer was effective in mitigating whisker formation for Sn-Cu alloys.

Authors, year, reference	Reported items
Zhang, 2000, [148]	Bright tin, satin bright tin, matte tin, and Sn-10Pb, plated over copper were investigated, at both room temperature and 50°C. No whisker growth was observed at the reflowed specimen.
Schetty, 2001, [149]	Effectiveness of tin plating thickness and Ni underlayer on mitigation of tin whisker formation was investigated. <ul style="list-style-type: none"> - As thin as 0.1µm of Ni underlayer was effective for the samples with copper substrate. - It was reported that thicker tin coating is less prone to whiskers. - Increase in copper content in the plating bath (0-6.4%) promoted whisker growth.
Schetty, 2-2001, [150]	Tin-platings deposited over brass using standard methane sulfonic acid (MSA) and non-MSA plating baths were investigated in terms of preferred orientation. <ul style="list-style-type: none"> - The preferred orientation for tin deposition from MSA was found to be (211), while that for tin deposition from non-MSA was (220). - It was also shown that MSA deposited plating exhibited compressive stress that increased with time.
Zhang, 2001, [151]	Based on XRD stress measurement, internal stresses were reported to be a key factor for the whisker growth.
Xu, 2001, [152]	Focused ion beam (FIB) analysis was used for the first time to characterize tin whiskers. The compressive stress, developed over time within tinplated on copper substrate, was indicated as an attribute to copper diffusion into the tin coating, while tensile stress was attributed to the nickel underlayer's ability to block copper diffusion.
Baundry, 2001, [153]	FIB cross-section showed that whisker was in contact with tin-copper intermetallics, emanating from the coating-substrate interface.
Vo, 2001, 2002, [57]	Tin-bismuth and tin-copper plating with or without nickel underlayer were evaluated for whisker formation. The experiment showed that temperature cycling (-55 to 85°C) accelerated whisker growth even with the use of a nickel underlayer. It was also shown that Sn-0.7Cu samples developed both longer and a larger number of whiskers, compared to pure tin plated samples.
Williams, 2001, [56]	It was reported that plating bath impurities may highly affect tin whisker formation. He proposed that internal compressive stress could be reduced by eliminating the formation of intermetallic compound at the tin plating/copper substrate interface.
Choi, 2002, [154]	The application of micro-diffractometry by synchrotron radiation to whisker characterization was reported for the first time.

Authors, year, reference	Reported items
Tu, 2002, [155]	Eutectic Sn-Cu plating on leadframe material was evaluated using focused ion beam and transmission electron microscopy. Major observation include: Pure tin deposit does not have any grain precipitate of Cu_6Sn_5 . The equation determining the diameter of whisker was proposed.
Sheng, 2002, [156]	Continuous copper diffusion from substrate was observed to maintain the internal stress level, based on experiment using $15\mu m$ -thick Sn-Cu and pure tin platings. Whiskers showed numerous dislocations in the vicinity of whisker kinks
Xu, 2002, [65]	Whiskers were observed to grow only externally, not within the coating. Ni underlayer poses a tensile stress on tin plating. Compressively-bent and non-bent samples had more whiskers than tensile-bent samples.
Zhang, 2002, [60]	Tin plating over copper with/without Ni was evaluated, along with 90degree bent and $260^\circ C$ reflow. Major findings include: Tensile stress retards whisker formation, while compressive stress accelerates the growth. Reflow at $260^\circ C$ and the use of Ni underlayer significantly mitigated whisker formation. Thicker plating ($>10\mu m$) was recommended as a possible mitigation strategy.
Egli, 2002, [157]	A model to predict the risk of whisker growth in tin deposit was proposed. Growth risk factors were correlated with the differences in crystallographic orientation of adjacent grains.
Lau, 2002, [158]	3-D non-linear stress analysis of tin whisker formation was first described. This analysis was based on the findings that whisker formation is an extrusion process where compressed tin plating was forced through some weak spots in the oxide layer.
Brusse, 2002, [43]	Tin whisker study on multi-layer ceramic chip capacitors. It was suggested that end user need to check the incoming parts, even though pure tin is prohibited by design and procurement practices.
Elmgren, 2002, [159]	Tin finishes over copper underlayer were observed to have significantly higher whisker growth, as compared to the tin finishes with Ni underlayer.
Schetty, 2002, [98]	Standard Methane Sulfuric Acid (MSA) electrolyte was observed to have preferred orientation of [211]. Non-MSA pure tin plating was observed to maintain the tensile stress at various storage conditions. Substrate material (e.g., C194, 7025, 151) was found to be an important factor influencing the stress state of tin plating. Different pre-treatment methods were observed to affect the stress within the substrate.

Authors, year, reference	Reported items
Whitlaw, 2002, [72]	<p>Twenty-two different tin finishes over brass, copper, and Alloy-42 were examined. Major observations include:</p> <p>Nickel underlayer was effective in whisker mitigation on brass substrate.</p> <p>Thicker coating (10μm) can help reducing whisker formation.</p>
Osterman, 2002, [87]	<p>Standard set of mitigation strategies, such as conformal coating and heat treatment for tin whiskers were reviewed, along with pros and cons of each strategy.</p>
Vo, 2002, [160]	<p>Pure tin, Sn-Bi, Sn-Cu, and Sn over Ni on the copper substrate were evaluated. It was shown that nickel underlayer was not effective under temperature cycling (-55 to 85°C) and temperature/humidity (55°C/95%RH) condition.</p>
Boguslavsky, 2003, [61]	<p>Recrystallization principles were discussed as a whisker growth mechanism. The driving force for recrystallization was identified to be stress fields due to dislocations. The driving force for secondary grain growth was identified to be grain boundary network stresses.</p>
LeBret, 2003, [161]	<p>Tin film sputtered deposit on brass substrate was investigated at room temperature, 50°C, and 150°C. No evidence of dislocations in the whiskers or the underlying grains were found. Intermetallic formation and temperature dependence of whisker growth was pointed out as a key factor in the recrystallization process.</p>
Whitlaw, 2003, [162]	<p>It was recommended that substrate materials should be etched to a minimum depth of 2.5μm prior to plating.</p> <p>Annealing at 150°C for one hour or the use of underlayer (e.g., Ni or Cu) was recommended as possible mitigation strategies.</p>
Dittes, 2003, [53]	<p>Pure tin platings (1.5 to 15μm thick) over typical leadframe materials were evaluated. Major observations include:</p> <p>Annealing at 150°C for one hour was effective to retard tin whisker formation.</p> <p>For ambient storage, no whiskers longer than 50μm in length were observed on any samples with either Ni or Ag underlayer.</p> <p>All the whiskers were arrested growth after about 150days.</p>
Romm, 2003, [163]	<p>A variety of commercial matte tin over various leadframe materials was evaluated at a 5-V electrical bias. Electrically biased samples generated consistent whiskers.</p>
Xu, 2003, [164]	<p>Various Ni underlayer and reflow condition were evaluated in terms of the effectiveness of tin whisker mitigation. Major observations:</p> <p>Ni underlayer was helpful to generate a tensile stress over time.</p> <p>For both room ambient and 50°C, tin whiskers were not observed on any of the samples with Ni underlayer for 6 months.</p> <p>Temperature cycling produced whiskers smaller than 50μm on the samples with Ni underlayer.</p>

Authors, year, reference	Reported items
Tsuji, 2003, [165]	<p>Role of grain boundary and surface free energy on whisker growth were discussed.</p> <p>It was indicated that minimization of surface free energies can be achieved by growing in specific directions and growing facets on the lateral surfaces.</p>
Madra, 2003, [166]	<p>The effect of molding on the stress state of tin-coated leadframes was modeled.</p>
Dittes-2, 2003, [73]	<p>Temperature cycling effect for tin plating over Alloy-42 was discussed. Major observations include:</p> <p>Tin whisker formation on Alloy-42 is strongly dependent on the number of applied temperature cycling, as opposed to copper substrate.</p> <p>Whisker length has a linear relationship with delta T (temperature). Growth rate appears to decay as a function of number of cycles or whisker length.</p>
Choi, 2003, [167]	<p>Whisker growth on eutectic Sn-Cu finishes was studied using X-ray diffraction.</p> <p>Whisker was observed to grow in [011] direction.</p> <p>Stress at whisker root was nearly zero and the surrounding regions were more compressively stressed.</p>
Okada, Higuchi, and Ando, 2003, [75]	<p>Stress analysis on whisker formation was conducted, as well as field reliability estimation of tin whiskers generated by thermal cycling stress.</p> <p>Whisker growth is not simply proportional to a fixed temperature for thermal cycling; is also related to the upper and lower temperature.</p> <p>Reflow seemed to retard whisker growth for thermal cycling and the growth arrested after 2200 cycles of 40 to 85°C.</p> <p>All the whiskers observed were smaller than 50µm in length.</p>
Pinsky and Lambert, 2004, [83]	<p>A level of 1-5 classification was proposed to correlate the potential risk to the mitigation for tin and zinc whisker issue.</p> <p>Algorithm was created to evaluate the application-specific risks, posed by whiskers.</p>
Zhang, 2004, [99]	<p>Tin whisker growths were examined with respect to the effect of substrate in order to differentiate the source of compressive stress</p>
Barsoum, 2004, [168]	<p>Driving force and mechanism for whisker growth was discussed with a focus on intermetallic growth between tin and substrate material.</p>

Authors, year, reference	Reported items
Vo, 2005, [169]	Discussions on iNEMI tin whisker test standardization activities including test results were reported.
Xu, 2005, [170]	Correlation between the rate of whisker formation and the amplitude of the applied compressive stress was discussed.
Su, 2005, [106]	Lead-free reflow process generated the uniform intensities of crystal orientations. Reflowed tin finish on singulated components tends to have much more uneven distribution on the leads, especially for small packages and shorter leads (resulting in thinner tin finish near the body of the package, which has a higher propensity of tin whiskers).
Ding, 2005, [171]	Before forming and trimming process, tin plating over leadframe material has relatively uniform grain size. At the deformed area of leads as a result of the trimming process, grain size increased. Whisker growth propensity was

Bibliography

- [1]. European Union, "Directive 2002/95/EC of the European Parliament and of the Council of 27 January 2003 on the Restriction of the Use of Certain Hazardous Substances in Electrical and Electronic Equipment," *Official Journal of the European Union*, pp. L37/19-L37/23, 13 February 2003.
- [2]. European Union, "Directive 2002/96/EC of the European Parliament and of the Council of 27 January 2003 on Waste of Electrical and Electronic Equipment," *Official Journal of the European Union*, L37/24-L37/38, 13 February 2003.
- [3]. Eveloy, V., S. Ganesan, Y. Fukuda, J. Wu, M. Pecht, Y. Fu, Y. Li, and M. Xu, "Lead-free Implementation Guidelines for Equipment Manufacturers," *Proceedings of Nepcon China Conference*, Shanghai, P.R. China, 11-15 April 2005.
- [4]. Fukuda, Y., P. Casey, and M. Pecht, "Evaluation of Selected Japanese Lead-free Consumer Electronics," *IEEE Transactions on Electronics Packaging Manufacturing*, Vol. 26, No. 4, pp. 305-312, October 2003.
- [5]. Ganesan, S., J. Wu, and M. Pecht, "Assessment of Long-term Reliability in Lead-free Assemblies," *Proceedings of International Conference on Asian Green Electronics*, Shanghai, China, pp. 140-155, 15-18 March 2005.
- [6]. Kariya, Y. and M. Otsuka, "Effect of Bismuth on the Isothermal Fatigue Properties of Sn-3.5mass%Ag Solder Alloy," *Journal of Electronic Materials*, Vol. 27, No. 7, pp. 866-870, 1998.
- [7]. Zhang, Q., A. Dasgupta, and P. Haswell, "Cyclic Mechanical Durability of Sn3.9Ag0.6Cu and Sn3.5Ag Lead-free Solder Alloys," *Proceedings of 2002 ASME International Mechanical Engineering Congress and Exposition*, New Orleans, LA, 2002.
- [8]. Choi, W. K., and H. M. Lee, "Effect of Soldering and Aging Time on Interfacial Microstructure and Growth of Intermetallics between Sn-Ag Solder and Cu substrates," *Journal of Electronic Materials*, Vol. 29, No. 10, pp. 1207-13, 2000.
- [9]. Fear, D. R., J. W. Jang, J. K. Lin, and C. Zhang, "Lead-free Solders for Flip-Chip Interconnects," *Journal of Materials*, Vol. 53, No. 6, pp. 28-32, 2001.
- [10]. Jeon, Y. D., A. Ostmann, H. Reichl, and K. W. Paik, "Comparison of Interfacial Reactions and Reliabilities of Sn3.5Ag, Sn4.0Ag0.5Cu, and Sn0.7Cu Solder Bumps on Electroless Ni-P UBMs," *Proceedings of the 53rd Electronic Components and Technology Conference*, pp. 1203-1208, 2003.
- [11]. Vianco, P., J. Rejent, I. Artaki, U. Ray, D. Finley, and A. Jackson, "Compatibility of Lead-free Solders with Lead Containing Surface Finishes as a Reliability Issue in Electronic Assemblies," *Proceedings of the Electronic Components and Technology Conference*, pp. 1172-1183, 1996.
- [12]. Swanson, J., Y. Zhang, "Lead-free Component Finishes-A Market and Technical Analysis," *Plating and Surface Finishing*, Vol. 89, No. 1, pp. 14-16, January 2002.

- [13]. Zhao, P., and M. Pecht, "Field Failure due to Creep Corrosion on Components with Palladium Pre-plated Leadframes," *Microelectronics Reliability*, Vol. 43, No. 5, pp. 775-778, 2003.
- [14]. Melton, C., and H. Fuerhapter, "Lead-free Tin Surface Finish for PCB Assembly," *Proceedings of the National Electronic Packaging and Production Conference*, Vol. 2, pp. 877-881, 1996.
- [15]. Nurmi, S. T., J. J. Sundelin, E. O. Ristolainen, T. K. Lepisto, "The Effect of PCB Surface Finish on Lead-free Solder Joints," *Soldering and Surface Mount Technology*, Vol. 17, No. 1, pp. 13-23, 2005.
- [16]. Ludwig, R., N-C. Lee, C. Fan, Y. Zhang, "Evaluation of Two Novel Lead-free Surface Finishes," *Proceedings of SPIE-The International Society for Optical Engineering*, Vol. 4931, pp. 697-703, 2002.
- [17]. Henshall, G., P. Roubaud, G. Chew, S. Prasad, F. Carson, R. Bulwith, and E. O'Keeffe, "Impact of Component Terminal Finish on the Reliability of Pb-free Solder Joints," *Journal of Surface Mount Technology*, Vol. 15, Issue 4, pp. 30-39, 2002.
- [18]. iNEMI (May 2005). "Recommendations on Lead-free Finishes for Components Used in High-Reliability Products," *Report of International Electronics Manufacturing Initiative*, <http://thor.inemi.org/webdownload/projects/ese/tin_whiskers/User_Group_mitigation_May05.pdf> (reviewed on 16 May 2005).
- [19]. Abbot, D. C., R. M., Brook, N. McLelland, and J. S., Wiley, "Palladium as a Lead Finish For Surface Mount Integrated Circuit Packages," *IEEE Transactions on Components, Hybrids Manufacturing Technology*, Vol. 14, No. 3, pp. 567-572, 1991.
- [20]. Fukuda, Y., K. Fukuda, S. Fukuda, and M. Pecht, "Lead-free Soldering in the Japanese Electronics Industry," *IEEE Transactions on Components and Packaging Technology*, Vol. 26, No. 3, pp. 616-624, September 2003.
- [21]. Sriyarunya, A., and R. Schetty, "Lead-free Plating for Semiconductor Devices Production Qualification and Implementation," *Proceedings of AFSF SUR/FIN*, Milwaukee, Wisconsin, pp. 187-198, 23-26 June 2003.
- [22]. Yoshikawa, S., "Lead-free, Sn-Cu Alloy Finishes," *Top Techno Focus*, No. 24, Vol. 3, pp. 1-5, 2001 (only available in Japanese).
- [23]. Arakane, H., "Control the Lead Content below 0.1%," *JEITA Lead-free Project Report*, pp. 97-105, February 2005.
- [24]. Pecht, M., Y. Fukuda, and S. Rajagopal, S., "The Impact of Lead-free Legislation Exemptions on the Electronics Industry," *IEEE Transactions on Electronics Packaging Manufacturing*, Vol. 27, No. 4, pp. 221-232, October 2004.
- [25]. Danielson, H., "Lead-free Soldering Causes Reliability Risks for Systems with Harsh Environment," *Advanced Microelectronics*, Vol. 29, No. 3, pp. 6-11, May/June 2002.
- [26]. Fukuda, Y., M. Osterman, "Tin Whiskers: What's the Risk?" *Advanced Packaging*, pp. 8-11, July 2005.

- [27]. Lasky, R., "Tin Pest: A Forgotten Issue in Lead-free Soldering?" *Proceedings of SMTA International Conference*, Chicago, IL, pp. 838-840, September 2004.
- [28]. Kariya, Y., N. Williams, C. Gagg, and W. Plumbridge, "Tin Pest in Sn-0.5wt% Cu Lead-free Solder," *Journal of Material Research Summary*, pp. 39-41, June 2001.
- [29]. JEDEC (May 2005). "Measuring Whisker Growth on Tin and Tin Alloy Surface Finishes," *JEDEC Standard 22A121*, released in May 2005.
- [30]. ASTM (2003). Standard Terminology Relating to Electroplating, *ASTM standard B374-96*, p.133-141, 2003.
- [31]. Department of Health, Education, and Welfare Public Health Service, "ITG Subject: Tin Whiskers-Problems, Causes, and Solutions," *Document number 42*, 14 March 1986.
- [32]. Koonce, S. E., and S. M. Arnold, "Metal Whiskers," *Journal of Applied Physics (letters to the editor)*, Vol. 25, No. 1, pp. 134-135, 1954.
- [33]. Koonce, S. E., and S. M. Arnold, "Growth of Metal Whiskers," *Journal of Applied Physics (letters to the editor)*, Vol. 24, No. 3, pp. 365-366, 1953.
- [34]. Key, P. L., "Surface Morphology of Whisker Crystals of Tin, Zinc, and Cadmium," *Proceedings of the IEEE Components Conference*, pp. 155-160, May 1970.
- [35]. Fisher, R. M., L. S. Darken and K. G. Carroll, "Accelerated Growth of Tin Whiskers," *Acta Metallurgica*, Vol. 2, No. 3, pp. 368-372, May 1954.
- [36]. Kehrer, H-P., H. G. Kadereit, "Tracer Experiments on the Growth of Tin Whiskers," *Applied Physics Letters*, Vol. 16, No. 11, pp. 411-412, 1970.
- [37]. Franks, J., "Growth of Whiskers in the Solid Phase," *Acta Metallurgica*, Vol. 6, pp. 103-109, February 1958.
- [38]. Tu, K. N., "Interdiffusion and Reaction in Bimetallic Cu-Sn Thin Films," *Acta Metallurgica*, Vol. 21, No. 4, pp. 347-354, April 1973.
- [39]. Cunningham, K. M., and M. P. Donahue, "Tin Whiskers: Mechanisms of Growth and Prevention," *Proceedings of 4th International SAMPE Electronics Conference*, CA, USA, Vol. 14, pp. 569-575, June 1990.
- [40]. Hada, Y., O. Morikawa, and H. Togami, "Study of Tin Whiskers on Electromagnetic Relay Parts," *Proceedings of the 26th Annual Relay Conference*, at Oklahoma State University, Stillwater, Oklahoma, pp. 9-1~9-15, April 25-26, 1978.
- [41]. Standard Specification for Electrodeposited Coatings of Tin, *ASTM standard B545-97*, pp. 252-259, 1998.
- [42]. Arnold, S. M., "The Growth and Properties of Metal Whiskers," *Proceedings of 43rd Annual Convention of the American Electroplater's Society*, pp. 26-31, 1956.
- [43]. Brusse, J. A., G. J. Ewell, and J. P. Siplon, "Tin Whiskers: Attributes and Mitigation," *Proceedings of 22nd Capacitor and Resistor Technology Symposium*, pp. 67-80, 25-29 March 2002.

- [44]. NASA, "Parts Advisory: Tin Whiskers," *Documentation of NASA Goddard Space Flight Center*, NA-044, pp. 1-5, 23 October 1998.
- [45]. Hasiguti, R.R., "A Tentative Explanation of the Accelerated Growth of Tin Whiskers," *Acta Metallurgica (letters to the editor)*, Vol. 3, No. 2, pp.200-201, March 1955.
- [46]. Kadesch, J. S., and J. A. Brusse, "The Continuing Dangers of Tin Whiskers and Attempts to Control Them with Conformal Coatings," *Proceedings of IMPAS Nordic 36th Annual Conference*, Helsingor, Denmark, 10-13 September 2000.
- [47]. Tu, K. N., "Irreversible Process of Spontaneous Whisker Growth in Bimetallic Cu-Sn Thin Film Reactions," *Physics Review B (Condensed Matter)*, Vol. 49, No. 3, pp. 2030-2034, January 1994.
- [48]. Cobb, H. L., "Cadmium Whiskers," *Monthly Review of American Electroplaters Society*, Vol. 33, No. 28, pp. 28-30, January 1946.
- [49]. NASA GSFC, (Jay Brusses), "Tin Whisker Growth Mechanics," MD
- [50]. Compton, K. G., A. Mendizza and S. M. Arnold, "Filamentary Growths on Metal Surfaces Whiskers," *Corrosion*, Vol. 7, No. 10, pp. 327-334, October 1951.
- [51]. Sears, G. W., "A Mechanism of Whisker Growth," *Acta Metallurgica*, Vol. 3, No. 4, pp. 367-369, July 1955.
- [52]. Livingston, H., "Reducing the Risk of Tin Whisker Induced Failures in Electronic Equipment," *Documentation of GEIA-G12 Solid State Devices Committee*, Document number GEB-0002, 1 December 2003.
- [53]. Dittes, M., P. Oberndorff, and L. Petit, "Tin Whisker Formation-Results, Test Methods, and Countermeasures," *Proceedings of 53rd Electronic Components and Technology Conference*, pp. 822-826, May 27-30, 2003.
- [54]. Lal, S., and T. D. Moyer, "The Role of Intrinsic Stresses in the Phenomena of Tin Whiskers in Electronic Connectors," *IEEE Transactions on Electronics Packaging Manufacturing*, Vol. 28, Issue 1, pp. 63-74, January 2005.
- [55]. Pitt, C. H., and R. G. Henning, "Pressure-Induced Growth of Metal Whiskers," *Journal of Applied Physics (communications)*, Vol. 35, Issue 2, pp. 459-460, 1964.
- [56]. Williams, M., C. Johnson, K-W. Moon, et. al, "NIST Sn Whisker Activities," Presented at *CALCE Lead-free Forum*, October 10, 2002, <<http://www.calce.umd.edu/lead-free/tin-whiskers/team/workshop021010/06NISTSnWhisker.pdf>> (reviewed on 3 July 2004).
- [57]. Nakadaira, Y., T. Matuura, M. Tsuruya, N. D. Vo, R. Kangas, J. Conrad, B. Sundram, K-H. Lee, and S. M. Arunasalam, "Pb-free Plating for Peripheral/Leadframe Packages," *Proceedings of Environmentally Conscious Design and Inverse Manufacturing Symposium*, pp. 213-218, 11-15, December 2001.
- [58]. Eshelby, J. D., "A Tentative Theory of Metallic Whisker Growth," *Physics Review*, Vol. 91, pp. 755-756, 1953.

- [59]. Frank, F. C., "On Tin Whiskers," *Philosophical Magazine*, Vol. 44, pp. 854-860, August 1953.
- [60]. Zhang, Y., C. Xu, C. Fan, J. A. Abys, and A. Vysotskaya, "Understanding Whisker Phenomenon, Whisker Index and Tin/Copper, Tin/Nickel Interface," *Proceedings of IPC SMEMA Council APEX 2002*, pp. S06-1-1~S06-1-8, January 2002.
- [61]. Boguslavsky, I., and P. Bush, "Recrystallization Principles Applied to Whisker Growth in Tin," *Proceedings of IPC/SMEMA Council APEX2003*, pp. S12-4-1~S12-4-10, March 2003.
- [62]. Ellis, W., D. Gibbons, and R. Treuting, "Growth of Metal Whiskers From the Solid," *Growth and Perfection of Crystals*, ed. Doremus, R. H., Roberts, B. W., Trunbull, D., NY, USA, John Wiley & Sons, pp. 102-120, 1958.
- [63]. Furuta, N., and K. Hamamura, "Growth Mechanisms of Proper Tin-Whisker," *Japanese Journal of Applied Physics*, Vol. 9, No. 12, pp. 1404-1410, December 1, 1969.
- [64]. Oberndorff, P., J. Klerk, M. Dittes, and P. Crema, "Whisker Formation on Sn-Plated Components," *Proceedings of the Conference on Electronics Goes Green 2004+*, pp. 347-352, Fraunhofer IZM, Berlin, Germany, 6-8 September 2004.
- [65]. Xu, C., Y. Zhang, C. Fan, J. Abys, L. Hopkins, and F. Stevie, "Understanding Whisker Phenomenon, Driving Force for the Whisker Formation," *Proceedings of IPC SMEMA Council APEX 2002*, pp. S06-2-1~S06-2-6, January 2002.
- [66]. Chang-Bing Lee, J., Y-L. Yao, F-Y. Chiang, P. J. Zheng, C. C. Liao, and Y. S. Chou, "Characterization Study of Lead-free Sn-Cu Plated Packages," *Proceedings of IEEE Electronic Components and Technology Conference*, pp. 1238-1245, 2002.
- [67]. Lee, B. Z., and D. N. Lee, "Spontaneous Growth Mechanism of Tin Whiskers," *Acta Materials*, Vol. 46, No. 10, pp.3701-3714, 1998.
- [68]. Sakamoto, I., "Status of Proposed IEC Whisker Test Methodologies," *JEITA Lead-free Project Report*, pp. 15-27, February 2005.
- [69]. Dunn, B. D., "A Laboratory Study on Tin Whisker Growth," *European Space Agency STR-223*, pp. 1-50, September 1987.
- [70]. Britton, S. C., "Spontaneous Growth of Whiskers on Tin Coatings: 20 Years of Observation," *Transactions of the Institute of Metal Finishing*, Vol. 52, pp. 95-102, April 1974.
- [71]. Schetty, R., Y. Zhang, and K. Hwang, "Whisker Growth: The Substrate Effect and Beyond," *Proceedings of International IEEE Conference on the Business of Electronic Product Reliability and Liability*, Shenzhen, China, pp. 1-5, January 15-17, 2003.
- [72]. Whitlaw, K., and J. Crosby, "An Investigation into Methods for Minimizing Tin Whisker Growth," *Proceedings of AFSF SUR/FIN*, Milwaukee, Wisconsin, pp. 289-298, June 23-26, 2003.

- [73]. Dittes, M., "The Effect of Temperature Cycling on Tin Whisker Formation," *Proceedings of IPC/JEDEC International Conference on Lead-free Electronic Components and Assemblies*, Frankfurt, Germany, October 2003.
- [74]. McDowell, M. E., "Tin Whiskers: A Case Study," *Proceedings of Aerospace Applications Conference*, pp. 207-215, January 31-February 5, 1993.
- [75]. Okada, S., S. Higuchi, and T. Ando, "Field Reliability Estimation of Tin Whiskers Generated by Thermal-Cycling Stress," *Proceedings of Capacitor and Resistor Technology Symposium*, pp. 1-10, October 2003.
- [76]. JIS (1998). "Environmental Test-Electric/Electronic Sine Wave Vibration Test Method," *Japanese Standard Association-JIS C0040*, pp. 197-198, 1998.
- [77]. JEDEC (March 2001). "Mechanical Shock" *JEDEC Standard 22B104B*, released in March 2001.
- [78]. Teverovsky, A., "Introducing a New Member to the Family: Gold Whiskers," *Internal Memorandum-NASA Goddard Space Flight Center*, pp. 1-6, April 2003.
- [79]. Long, M., "Processor Problem Continues to Dog Boeing Satellite," *Electronic News*, 14 May 2002.
- [80]. Dore, R., "Launches of Hughes HS 601 Satellites Ready to Resume," *Press Release of Hughes Electronics Corporation*, 11 August 1998.
- [81]. Brusse, J. A., "Metal Whisker Discussion-Tin and Zinc Whiskers," *Presentation at the ACI-NAVAIR-Pb-free Meeting*, 27 April 2004.
- [82]. Freescale (September 2004), "Environmentally Preferred Products-Development of Lead-free and Bromine-free Solution," <http://www.freescale.com/files/product/doc/ENV_PBFREEOV2.pdf> (reviewed on 31 March 2005).
- [83]. Pinsky, D., and E. Lambert, "Tin Whisker Risk Mitigation for High-Reliability Systems Integrators and Designers," *Technical Report of Raytheon*, March 2004, <http://www.reliabilityanalysislab.com/tl_dp_0403_TinWhiskerRiskMitigation.asp> (reviewed on 17 July 2004).
- [84]. JEDEC (April 2005). "Environmental Acceptance Requirements for Tin Whisker Susceptibility of Tin and Tin Alloy Surface Finishes," *Final Draft of JEDEC Standard No. 201 for Ballot*, released in 5 April 2005.
- [85]. Smetana, J., "NEMI Tin Whisker User Group-Tin Whisker Acceptance Test Requirements," Report of NEMI Tin Whisker Workshop, Las Vegas, NV, 1-2 June 2004.
- [86]. Galyon, G. T., and R. Gedney, "Avoiding Tin Whisker Reliability Problems," *Circuit Assembly*, pp. 26-31, August 2004.
- [87]. Osterman, M., "Mitigation Strategies for Tin Whiskers," *White Paper of CALCE EPSC*, Release 1.0, 28 August 2002, <<http://www.calce.umd.edu/lead-free/tinwhiskers/TINWHISKERMITIGATION.pdf>> (reviewed on 22 February 2005).

- [88]. Pinsky, D., M. Osterman, and S. Ganesan, "Tin Whiskering Risk Factors," *IEEE Transactions on Components and Packaging Technologies*, Vol. 27, No. 2, pp. 427-431, June 2004.
- [89]. Military Standard, "Capacitor, Fixed, Ceramic Multi-layer, High-voltage (general purpose)," *Military Standard-MIL-PRF-49467*, Revision C, 12 May 2005.
- [90]. Defense Logistics Agency, June 2004, "Use of Pure Tin in Hybrid Microcircuits, MIL-PRF-38534," *Letter released by Defense Logistics Agency*, DSCC-VQH-04-6430, 2 June 2004.
- [91]. Jeffers, B., "Capacitor Tin Whisker White Paper-Is it Tinned Yet?" *Proceedings of IPC/JEDEC International Conference on Lead-free Electronic Components and Assembly*, San Jose, CA, USA, April 2003.
- [92]. Raytheon, Engineering Fellow (Rollins, B.), "Tin Whisker Telecon-May 18 2005," MA, 18 May 2005.
- [93]. Leidecker, H., and J. S., Kadesch, "Effects of Uralane Conformal Coating on Tin Whisker Growth," *Proceedings of IMAPS Nordic, the 37th IMAPS Nordic Annual Conference*, pp. 108-116, 10-13 September 2000.
- [94]. Woodrow, T. A., and E. A. Ledbury, "Evaluation of Conformal Coatings as a Tin Whisker Mitigation Strategy," *Proceedings of IPC/JEDEC 8th International Conference on Lead-free Electronic Components and Assemblies*, pp. 1-25, San Jose, CA, 18-20 April 2005.
- [95]. Hom, B., "Lead-free Component Termination Finish Recommendation," *Presentation at the CALCE Lead-free Forum*, 1 July 2004.
- [96]. Whitlaw, K., and J. Crosby, "An Empirical Study into Whisker-Growth of Tin and Tin Alloy Electrodeposits," *Proceedings of the 2002 AESF SUR/FIN Conference*, pp. 19-30, June 2002.
- [97]. Schetty, R., "Tin Whisker Studies Experimentation and Mechanistic Understanding," *Proceedings of AESF SUR/FIN Conference*, Chicago, IL, pp. 7-17, June 2002.
- [98]. Schetty, R., "Tin Whisker Studies Experimentation and Mechanistic Understanding," *Proceedings of AESF SUR/FIN Conference*, Chicago, IL, pp. 7-17, June 2002.
- [99]. Zhang, Y, C. Fan, C. Xu, O. Khaselev, and J. A. Abys, "Tin Whisker Growth-Substrate Effect Understanding CTE Mismatch and IMC Formation," *Proceedings of IPC/APEX 2004*, Anaheim, CA, 23-26 February 2004.
- [100]. Glazunova, V. K., "A Study of the Influence of Certain Factors on the Growth of Filamentary Tin Crystals," *Kristallografiya*, Vol. 7, No. 5, pp. 761-768, September-October 1962.
- [101]. Rozen, M., "Practical Whisker Growth Control Methods," *Plating*, Vol. 55, No. 11, pp. 1155-1168, November 1968.
- [102]. Sabbagh, N. A. J., and H. J. McQueen, "Tin Whiskers: Causes and Remedies," *Metal Finishing*, pp. 27-31, March 1975.
- [103]. Toben, M., A. Egli, J. Heber, and A. Vinkier, "Tin Whiskers: An Overview of the Mechanisms that Drive their Growth," *Proceedings of 34th*

Annual IICIT Connector and Interconnection Symposium and Trade Show,
Waretown, NJ, USA, pp. 29-36, 2001.

- [104]. IBM (October 2004). "IBM Server and Storage System's Environmental Requirements for Purchased Electronic Components," *IBM Engineering Specification*, Document Number: 77P0594, EC: J33709, 28 October 2004.
- [105]. Kakeshita, T., R. Kawanaka, and T. Hasegawa, "Grain Size Effect of Electro-plated Tin Coatings on Whisker Growth," *Journal of Material Science*, Vol. 17, pp. 2560-2566, 1982.
- [106]. Su, P., M. Ding, and S. Chopin, "Effect of Reflow on the Microstructure and Whisker Growth Propensity of Sn Whisker," *Proceedings of the 2005 Electronic Components and Technology Conference*, pp. 434-440, June 2005.
- [107]. Shook, R., "The Effects of Board Assembly Reflow Processing on Sn Whisker Formation," *Proceedings of IPC/JEDEC Conference on Lead-free Electronic Components and Assemblies*, San Jose, 17-19 March 2004.
- [108]. Abbot, D., and D. Romm, "TI Tin Whisker and Pb-free Finish Evaluations," *Proceedings of MASS Toxic Use Reduction Institute, Pb-free Electronics Workshop*, Marlborough, 19 June 2003.
- [109]. Osenbach, J. W., R. L. Shook, B. T. Vaccaro, B. D. Potteiger, and A. Amin, "Lead-free Plating and Sn-Whiskers," *Proceedings of 2004 Electronic Components and Technology Conference*, pp. 1314-1324, 2004.
- [110]. Hilty, R. D, N. E. Corman, and H. Herrmann, "Electrostatic Fields and Current-Flow Impact on Whisker Growth," *IEEE Transactions on Electronics Packaging Manufacturing*, Vol. 28, No. 1, pp. 75-84, January 2005.
- [111]. Liu, S. H., C. Chen, P. C. Liu, and T. Chou, "Tin Whisker Growth Driven by Electrical Currents," *Journal of Applied Physics*, Vol. 95, No. 12, pp. 7742-7747, 15 June 2004.
- [112]. ASTM (1998). Standard Specifications for Electrodeposited Coatings of Tin, *ASTM standard B545-97*, p.252-259, 1998.
- [113]. Westwater, A., "Lead-free Experience-2: Components in Lead-free Environment," *Proceedings of the NEPCON Conference*, pp. 1-6, Brighton, 2004.
- [114]. IPC (2004). "Ionic Analysis of Circuit Board, Ion Chromatography Method-5/04," *IPC standard IPC-TM-650-2.3.28*, released in May 2004.
- [115]. Bradshaw, R., "Evaluation of BME Ceramic Capacitors after Sn-Pb Replate over 100% Matte Tin," *JDI-BME Test Report by Crane Aerospace Interpoint*, pp. 1-25, 26 July 2004.
- [116]. Glary Power Technology (2005), "Power Converters-CPH series (CPH48120ABCD-25R0105)," *Product Announcement from Glary Power Technology*, <www.glary.com/NEW.htm> (reviewed on 29 June 2005).
- [117]. Haimovich, J., "Hot Air Leveled Tin: Solderability and Some Related Properties," *Proceedings of 39th Electronic Components Conference*, pp. 107-112, May 1989.

- [118]. Kanji, G. K., 100 Statistical Tests, SAGE Publications, London, UK, 1993.
- [119]. Romeu, J. L., "Anderson-Darling: A Goodness of Fit Test for Small Samples Assumptions," *Publication of the Department of Defense Reliability Analysis Center*, Vol. 10, No. 5, pp. 1-6, 2003.
- [120]. Anderson, T. W., and D. A. Darling, "Asymptotic Theory of Certain Goodness of Fit Criteria Based on Stochastic Process," *Annals of Mathematical Statistics*, Vol. 23, pp. 193-212, June 1952.
- [121]. Izenman, A. J., "Recent Developments in Non-Parametric Density Estimation," *Journal of American Statistical Association*, Vol. 86, No. 413, pp. 205-213, March 1991.
- [122]. Montgomery, D. C., Design and Analysis of Experiments, John and Wiley and Sons, Inc., New York, NY, 1997.
- [123]. Kawanaka, R., K. Fujiwara, S. Nango, and T. Hasegawa, "Influence of Impurities on the Growth of Tin Whiskers," *Japanese Journal of Applied Physics*, Vol. 22, No. 6, pp. 917-922, June 1983.
- [124]. Herring, C., and J. K. Galt, *Physics Review*, Vol. 85, No. 6, pp. 1060-1061, March 1952.
- [125]. Peach, M. O., "Mechanism of Growth of Whiskers on Cadmium," *Journal of Applied Physics (letters to the editor)*, Vol. 23, No. 12, pp. 1401-1403, 1952.
- [126]. Amelinckx, S., W. Bontinck, W. Dekeyser, and F. Seitz, "On the Formation and Properties of Helical Dislocations," *Physics Magazine 8th* Vol. 2, No. 15, pp. 355-377, March 1957.
- [127]. Baker, G. S., "Angular Bends in Whiskers," *Acta Metallurgica*, Vol. 5, No. 7, pp. 353-357, July 1957.
- [128]. Glazunova, V. K., and N. T. Kudryavtsev, "An Investigation of the Conditions of Spontaneous Growth of Filiform Crystals on Electrodeposit Coatings," *Translated from Zhurnal Prikladnoi*, Vol. 36, No. 3, pp. 543-550, March 1963.
- [129]. Britton, S. C., and M. Clarke, "Effects of Diffusion from Brass Substrates into Electrodeposited Tin Coatings on Corrosion Resistance and Whisker Growth," *Proceedings of the 6th International Metal Finishing Conference*, pp. 205-211, May 1964.
- [130]. Ellis, W. C., "Morphology of Whisker Crystals of Sn, Zn, and Cd Grown Spontaneously from the Solid," *Transactions of the Metal Society of AIME*, Vol. 236, pp. 872-875, June 1966.
- [131]. Rozen, M., and M. Renaud, "Effects of Temperature on Bright Acid Tin-Plated Deposits," *Plating*, Vol. 54, No. 10, pp. 1019-1024, October 1970.
- [132]. Leidheiser H. Jr., *The Corrosion of Copper, Tin, and Their Alloys*, John Wiley & Sons, New York, NY, USA, pp. 334-339, 1971.
- [133]. Jafri, A., "Fighting Whisker Growth in the Communication Industry," *Plating*, Vol. 60, No. 4, pp. 358-359, April 1973.

- [134]. Lindborg, U., "Observations on the Growth of Whisker Crystals from Zinc Electroplate," *Metallurgical Transactions A*, Vol. 6A, pp. 1581-1586, August 1975.
- [135]. Dunn, B. D., "Metallurgy and Reliability in Spacecraft Electronics," *Metals and Materials*, Vol. 34, pp. 32-40, March 1975.
- [136]. Dunn, B., "Whisker Formation on Electronic Materials," *ESA Scientific and Technical Review*, Vol. 2, No. 1, 1976.
- [137]. Lindborg, U., "A Model for the Spontaneous Growth of Zn, Cadmium, and Tin Whiskers," *Acta Metallurgica*, Vol. 24, No. 2, pp. 181-186, February 1976.
- [138]. Zakraysek, L., "Whisker Growth from a Bright Acid Tin Electrodeposit," *Plating and Surface Finishing*, Vol. 64, No. 3, pp. 38-43, March 1977.
- [139]. Tu, K. N., and R. D. Thompson, "Kinetics of Interfacial Reaction in Bimetallic Cu-Sn Thin Films," *Acta Metallurgica*, Vol.30, No. 5, pp. 947 -952, May 1982.
- [140]. Nordwall, B. D., "Air Force Links Radar Problems to Growth of Tin Whiskers," *Aviation Week and Space Technology*, pp. 65-68, June 30, 1986.
- [141]. Corbid, L., "Constraints on the Use of Tin Plate in Miniature Electronic Packages," *Proceedings of the 3rd International SAMPE Electronics Conference*, pp. 773-778, June 1989.
- [142]. Selcuker, A., and M. Johnson, "Microstructural Characterization of Electrodeposited Tin Layer in Relation to Whisker Growth," *Proceedings of Capacitor and Resistor Technology Symposium (CARTS)*, pp. 19-22, October 1990.
- [143]. Harris, P., "The Growth of Tin Whiskers," *Report of International Tin Research (ITRI)*, No. 734, pp. 1-7, 1994.
- [144]. Tu., K. N., "Cu/Sn Interfacial Reactions: Thin Film Case versus Bulk Case," *Materials Chemistry and Physics*, Vol. 46, No. 2-3, pp. 217-223, November-December 1996.
- [145]. Ewell, G. J., and F. Moore, "Tin Whiskers and Passive Components: A Review of the Concerns," *Proceedings of the 18th Conference on Capacitor and Resistor Technology (CARTS)*, pp. 222-228, March 1998.
- [146]. Yanada, I., "Electroplating of Lead-Free Solder Alloys Composed of Sn-Bi and Sn-Ag," *Proceedings of the IPC Printed Circuits Expo*, Long Beach, USA, pp. S11-2~S11-2-7, April 1998.
- [147]. Schetty, R., "Minimization of Tin Whisker Formation for Lead-free Electronic Finishing," *Proceedings of the IPC Works Conference*, Miami, USA, pp. S02-R3-1~S02-3-6, 2000.
- [148]. Zhang, Y., C. Xu, C. Fan, and J. Abys, "Tin Whisker Growth and Prevention," *Journal of Surface Mount Technology*, Vol. 13, No. 4, pp. 1-9, October 2000.

- [149]. Schetty, R., "Minimization of Tin Whisker Formation for Lead-Free Electronics Packaging," *Circuit World*, Vol. 27, No. 2, pp. 17-20, 2001.
- [150]. Schetty, R., N. Brown, A. Egli, J. Heber, and A. Vinckler, "Lead-Free Finishes-Whisker Studies and Practical Methods for Minimizing the Risk of Whisker Growth," *Proceedings of the AESF SUR/FIN Conference*, pp. 1-5, June 2001.
- [151]. Zhang, Y., C. Xu, C. Fan, A. Vysotskaya, and J. Abys, "Understanding Whisker Phenomenon-Part I: Growth Rates," *Proceedings of the 2001 AESF SUR/FIN Conference*, June 2001.
- [152]. Xu, C., C. Fan, A. Vysotskova, J. Abys, Y. Zhang, L. Hopkins, and F. Stevie, "Understanding Whisker Phenomenon-Part II, Competitive Mechanisms," *Proceedings of the 2001 AESF SUR/FIN Conference*, June 2001.
- [153]. Baudry, I., and G. Kerros, "FIB in Microelectronics Packaging Applications-Lead-free Plating Analysis," *Soldering and Assembly Technology 3*, November 2001.
- [154]. Choi, W. J., T. Y. Lee, K. N. Tu, N. Tamura, R. S. Celestre, A. A. McDowell, Y. Y. Bong, L. Nguyen, and G. T. T. Sheng, "Structure and Kinetics of Sn Whisker Growth on Pb-free Solder Finish," *Proceedings of 52nd Electronic Components and Technology Conference*, pp. 628-633, May 28-31, 2002.
- [155]. Tu, K. N., and K. Zeng, "Reliability Issues of Pb-free Solder Joints in Electronic Packaging Technology," *Proceedings of 52nd Electronic Components and Technology Conference*, pp. 1194-1200, May 28-31, 2002.
- [156]. Sheng, G. T. T., C. F. Hu, W. J. Choi, K. N. Tu, Y. Y. Bong, and L. Nguyen, "Tin Whiskers Studied by Focused Ion Beam Imaging and Transmission Electron Microscopy," *Journal of Applied Physics*, Vol. 92, No. 1, pp. 64-69, July 2002.
- [157]. Egli, A., W. Zhang, J. Heber, F. Schwater, and M. Toben, "Where Crystal Planes Meet: Contribution to the Understanding of the Whisker Growth Process," *Proceedings of the IPC Annual Meeting*, pp. S08-3-1~S08-3-5, November 2002.
- [158]. Lau, J., and S. Pan, "3D Nonlinear Stress Analysis of Tin Whisker Initiation on Lead-Free Components," *Proceedings of NEPCON West and FIBEROPTIC Conference*, San Jose, CA, pp. 293-297, December 3-6, 2002.
- [159]. Elmgren, P., "Tin Whisker Formation on Lead-Free Coatings," *Molex Advanced Development Report*, pp. 1-8, October 2002.
- [160]. Vo, N., and M. Tsuruya, "Whisker Assessment of Tin-Based Finishes for Leadframe Packages," *Proceedings of the 2002 ECO Design Japan Symposium*, pp. 120-123, December 2002.
- [161]. LeBret, J. B., and M. G. Norton, "Electron Microscopy Study of Tin Whisker Growth," *Journal of Materials Research*, Vol. 18, No. 2, pp. 585-593, March 2003.
- [162]. Whitlaw, K., A. Egli, and M. Toben, "Preventing Whiskers in Electrodeposited Tin for Semiconductor Lead Frame Applications," *Proceedings*

of the IPC International Conference on Lead-free Electronics, Brussels, June 2003.

[163]. Romm, D. W., D. C. Abbot, S. Grenney, and M. Khan, "Whisker Evaluation of Tin-Plated Logic Component Leads," *Application Note of Texas Instrument*, SZZA037A, pp. 1-27, February 2003.

[164]. Xu, C., C. Fan, Y. Zhang, and J. Abys, "Whisker Prevention," *Proceedings of the 2003 APEX Conference*, Anaheim, CA, April 2003.

[165]. Tsuji, K., "Role of Grain-Boundary Free Energy and Surface Free Energy for Tin Whisker Growth," *Proceedings of AFSF SUR/FIN*, Milwaukee, Wisconsin, pp. 169-186, June 23-26, 2003.

[166]. Madra, S., "Thermo-Mechanical Characterization of Lead-Free Tin Plating: X-Ray Diffraction Measurements and Correlation with Analytical and Numerical Models," *Proceedings of the IPC/JEDEC Conference*, Frankfurt, Germany, June 2003.

[167]. Choi, W. J., T. Y. Lee, K. N. Tu, N. Tamura, R. S. Celestre, A. A. McDowell, Y. Y. Bong, and L. Nguyen, "Tin Whiskers Studied by Synchrotron Radiation Scanning X-ray Micro-Diffraction," *Acta Materialia*, Vol. 51, No. 20, pp. 6253-6262, November 2003.

[168]. Barsoum, M. W., E. N. Hoffman, R. D. Doherty, S. Gupta, and A. Zavaliangos, "Driving Force and Mechanism for Spontaneous Metal Whisker Formation," *Physical Review Letters*, Vol. 93, No. 20, pp. 206104-1 to 206103-4, 12 November 2004.

[169]. Vo, N., M. Kwaka, and P. Bush, "Tin Whisker Test Standardization," *IEEE Transactions on Electronics Packaging and Manufacturing*, Vol. 28, No. 1, pp. 3-9, January 2005.

[170]. Xu, C., Y. Zhang, C. Fan, and J. A. Abys, "Driving Force For the Formation of Sn Whiskers: Compressive Stress-Pathways for its Generation and Remedies for Its Elimination and Minimization," *IEEE Transactions on Electronics Packaging and Manufacturing*, Vol. 28, No. 1, pp. 31-35, January 2005.

[171]. Ding, M., P. Su, S. Chopin, "Effect of Trim and Form on the Microstructure and Whisker Propensity of Sn Finish," *Proceedings of Electronics Components and Packaging Technology*, pp. 137-144, Las Vegas, NV, 31 May-3 June 2005.