

ABSTRACT

Title of dissertation: HYPERCOORDINATE SILICON COMPOUNDS IN ORGANIC SYNTHESIS: IMPROVED METHODS FOR THE SYNTHESIS OF ARYL(TRIALKOXY)SILANE DERIVATIVES; AND TRIMETHYLSILYL CYANIDE AS A CYANIDE SOURCE FOR NUCLEOPHILIC SUBSTITUTION

Amy Slover Manoso, Doctor of Philosophy, 2004

Dissertation directed by: Professor Philip DeShong
Department of Chemistry and Biochemistry

Palladium-catalyzed cross-coupling reactions are versatile methods for the synthesis of carbon-carbon bonds. The Stille and Suzuki cross-coupling protocols have achieved prominence in the synthesis of pharmaceuticals and agrochemicals because of the high yields, tolerance for functional groups, and excellent stereoselectivities. However, there are features associated with each of these processes that limit the generality: the Stille tin reagents and byproducts are toxic; and the Suzuki boron reagents can be difficult to synthesize and purify. Environmentally benign arylsilane derivatives have emerged as powerful alternatives to conventional arylmetaloids for the Pd(0)-catalyzed aryl-aryl coupling reaction with organohalides and organo(pseudo)halides because they avoid the inherent limitations associated with traditional methodologies. It was previously reported that aryl(trialkoxy)silanes (also called siloxanes) are substrates for fluoride-promoted, Pd(0)-catalyzed coupling reactions with allylic ester and aryl

derivatives providing cross-coupling products in high yields under mild conditions. However, few detailed studies of the synthesis of these useful cross-coupling reagents have been reported in the literature.

In chapter one of this thesis, two methods for the synthesis of aryl siloxanes are studied and the optimal reaction conditions and the scope determined: (1) general reaction conditions for the synthesis of aryl(trialkoxy)silanes from aryl Grignard and lithium reagents and functional silanes have been developed; and (2) the scope of the palladium-catalyzed silylation of aryl halides with triethoxysilane to generate aryl(trialkoxy)silane derivatives has been expanded. In tandem, these two methods provide ready access to a wide range of aryl siloxane reagents for use in Pd(0)-mediated cross-coupling reactions, including highly functionalized siloxane intermediates in the synthesis of useful biologically active compounds.

In the first part of chapter one, the synthesis of aryl siloxanes from the corresponding aryl organometallic reagent and tetraalkoxysilanes is described. Although examples in the literature have reported the use of a range of silicon electrophiles (including SiCl_4 and Cl-Si(OR)_3), tetraalkyl orthosilicates (Si(OR)_4) allow for the most direct and convenient synthesis of arylsiloxanes, in that they are commercially available, inexpensive, and air and moisture stable. Using the reaction conditions developed herein, *o*-, *m*- and *p*-substituted bromoarenes underwent equally efficient metallation and silylation. Mixed results were obtained with heteroaromatic substrates: 3-bromothiophene, 3-bromo-4-methoxypyridine, 5-bromoindole, and *N*-methyl-5-bromoindole all underwent silylation in good yield, whereas a low yield of siloxane was obtained from 2-bromofuran, and 2-bromopyridine failed to be silylated.

The synthesis of siloxanes *via* organo lithium and magnesium reagents is limited by the formation of di- and triarylated silanes ($\text{Ar}_2\text{Si(OR)}_2$, and Ar_3SiOR , respectively), and dehalogenated (Ar-H) by-products. Lower temperatures allowed for the formation of predominantly monoaryl siloxanes, without requiring a large excess of the electrophile. Optimal reaction conditions for the synthesis of siloxanes from aryl Grignard reagents

entailed addition of aryl magnesium reagents to 3 equiv of tetraethoxy- or tetramethoxysilane at $-30\text{ }^{\circ}\text{C}$ in THF. Aryl lithium species were silylated using 1.5 equiv of tetraethoxy- or tetramethoxysilane at $-78\text{ }^{\circ}\text{C}$ in ether. The proposed mechanism of silylation involves formation of the anionic pentacoordinate monoaryl(tetraalkoxy)silicate ($\text{ArSi}(\text{OR})_4^-$), which unexpectedly is susceptible to nucleophilic attack by a second equivalent of the aryl metalloid to form diaryl(dialkoxy)siloxane by-products. The reductive dehalogenation of the aryl halide starting material presumably occurs during the metallation step, and is an inherent limitation of the use of organometallic reagents.

The second part of chapter one discusses an alternative to the preparation of arylsilanes from organomagnesium or lithium intermediates: the silylation of aryl halide derivatives by triethoxysilane ($\text{H-Si}(\text{OEt})_3$) in the presence of a Pd catalyst. As initially reported in the literature, the silylation reaction was limited to *p*-substituted, electron-rich aryl iodide substrates. As described in this thesis, a more general Pd(0)-catalyst/ligand system has been developed which activates bromides and iodides: palladium (0) dibenzylideneacetone ($\text{Pd}(\text{dba})_2$) is activated with 2-(di-*tert*-butylphosphino)biphenyl (Buchwald's ligand) (1: 2 mole ratio of Pd : phosphine). Electron-rich, *para*- and *meta*-substituted aryl halides (including unprotected anilines and phenols) underwent silylation to form the corresponding aryl(triethoxy)silane in fair to excellent yield; however, *ortho*-substituted aryl halides failed to be silylated. Aryl chlorides were inert under the reaction conditions, and triflates were poor substrates for silylation, instead undergoing highly efficient reductive deoxygenation. The optimum silylation reagent is triethoxysilane; hexamethoxydisilane failed to be activated under a range of conditions. The major by-product of this reaction is reductive dehalogenation of the aryl halide starting material. Probable mechanisms for the silylation reaction and the reduction side-reaction are presented and discussed.

The Pd-catalyzed silylation method is an excellent companion to the more traditional organometallic approach to the formation of the Ar-Si bond. Case in point, *ortho*-substituted aryl siloxanes are readily synthesized from the Grignard or lithium

reagent. Unlike the metallation approach, the Pd-catalyzed silylation technique can be performed in the presence of a wide range of functional groups, including carbonyl-containing electrophiles, and protic moieties such as phenols or primary amines.

In addition to the fluoride-promoted transfer of aryl moieties presented in chapter one, silanes have also been shown to transfer nucleophiles such as azide and cyanide anion. Chapter two presents the development of a high yielding silicon-based method for the preparation of alkyl nitriles, which serve as precursors to a variety of useful functional groups. Hypercoordinate cyanosilicate, prepared *in situ* by the reaction of cyanotrimethylsilane (Me_3SiCN) with tetrabutylammonium fluoride (TBAF), is an effective source of nucleophilic cyanide. Primary and secondary alkyl halides and sulfonates underwent rapid and efficient cyanide displacement in the absence of phase transfer catalysts with the silicate derivative; inversion of configuration was observed for optically active alkyl halide substrates. Tetrabutylammonium fluoride was the optimum activating agent, and a full equivalent of fluoride ion was required for reaction completion. A nearly 1 : 1 stoichiometry of substrate to cyanosilicate affected formation of alkyl nitriles in acetonitrile or dioxane; in contrast, traditional methodologies typically employ a large excess of reagents, toxic phase transfer catalysts or solvents such as DMSO, or heavy-metal cyanide salts. Relative to other cyanide sources, the hypercoordinate cyanosilicate was much less basic, thereby mitigating the formation of elimination (alkene) by-products. The Me_3SiCN /TBAF system is significantly less reactive and less basic than tetrabutylammonium cyanide (TBA-CN), therefore the mechanism of reaction most likely involves the *in situ* generation of a hypercoordinate cyanosilicate, rather than disproportionation of Me_3SiCN and TBAF to form TBA-CN *in situ*.

HYPERCOORDINATE SILICON COMPOUNDS IN ORGANIC SYNTHESIS:
IMPROVED METHODS FOR THE SYNTHESIS OF ARYL(TRIALKOXY)SILANE
DERIVATIVES; AND TRIMETHYLSILYL CYANIDE AS A
CYANIDE SOURCE FOR NUCLEOPHILIC SUBSTITUTION

by

Amy Slover Manoso

Dissertation submitted to the Faculty of the Graduate School of the
University of Maryland, College Park in partial fulfillment
of the requirements for the degree of
Doctor of Philosophy
2004

Advisory Committee:

Professor Philip DeShong, Chair/Advisor
Assistant Professor Lyle Isaacs
Professor Paul Mazzocchi
Professor Donald Nuss (Center for Biosystems Research)
Professor Lawrence R. Sita

©Copyright by
Amy Slover Manoso
2004

DEDICATION

To my parents, Tina and Bill,
husband, Mark
sister and her partner, Betsy and Tanya
and baby Spence

ACKNOWLEDGMENTS

I would like to express my sincerest thanks to my advisor, Professor Philip DeShong. Everything that I am today has in some way been influenced by Phil: I am a better bench chemist, scientific writer, teacher, thinker, chemical professional, public speaker and—oddly enough—daughter and spouse due to his example. Thanks for helping me keep my priorities in order, for insisting that I take myself seriously as a chemist, and for teaching me not to panic.

My husband, Mark, has provided constant encouragement; I can definitively say that he has put in double the effort of any other spouse in the history of the DeShong group, because it has taken me twice as long. Without him, I could not have made it to this point. Thanks for making me finish what I started.

I would also like to thank Dr. Jim Demas (University of Virginia) for encouraging me to do undergraduate research and to drop my Latin American Studies major. You were right: organic chemistry is a highly creative and artistic endeavor, and a liberal art in its own right; of course you are a physical chemist and I think at the time you meant it as a snub. I forgive you.

Dr. James Whitney (Washington and Lee University) taught me that, when in doubt, the answer is "steric hindrance." Thank you for introducing me to organic chemistry and for being the first on a short list of phenomenal science teachers to show me that excellent science teaching is possible in a large lecture setting. You are deeply missed.

I am grateful for the support of my colleagues in the DeShong group. You have been a valuable source of friendship, advice, and commiseration over the past years. I have seen some thirty-odd faces grace the DeShong laboratories, too many to name: "I don't know half of you half as well as I should like; and I like less than half of you half as well as you deserve." –J. R. R. Tolkien.

From the Department, I would like to thank the organic faculty for outstanding teaching and guidance on matters both chemical and personal. Dr. Yui-Fai Lam and Caroline Ladd have provided invaluable assistance in obtaining NMR and mass spectral data.

And finally, to my parents: this is the culmination of all of your love and effort, and without you I could not have made it this far. Thank you.

TABLE OF CONTENTS

List of Tables	v
List of Figures	vii
List of Schemes	viii
List of Abbreviations	xiii
Chapter 1: Improved Synthesis of Aryl(triethoxy)silanes for Use in Palladium-Mediated Cross-Coupling Reactions	
Introduction	1
Significance of Aryl(trialkoxy)silanes	1
Synthesis of Natural Products Using Aryl(trialkoxy)silane Derivatives	7
Research Goal: Synthesis of Aryl(trialkoxy)silane Derivatives	18
Overview of the Synthesis of Aryl Group Transfer Reagents	20
Preparation of Aryl Stille (Tin) Reagents	23
Preparation of Aryl Suzuki (Boron) Reagents	25
Preparation of Aryl Silicon Reagents	30
Results and Discussion	40
Improved Synthesis of Aryl(trialkoxy)silanes via Treatment of Aryl Grignard or Lithium Reagents with Tetraalkoxysilane	40
Improved Methods for the Synthesis of Aryl(triethoxy)silanes via Palladium(0)-Catalyzed Silylation of Aryl Iodides and Bromides with Triethoxysilane	59
Conclusions	77
Epilogue	79
Experimental	81
Chapter 2: Trimethylsilyl Cyanide As A Cyanide Source For Nucleophilic Substitution	
Introduction	118
Fluoride Ion Activation of Silicon Bonds	118
Atomic and Molecular Properties of Tetracoordinate and Hypercoordinate Organosilicates	122
Synthesis, Stability and Characterization of Hypercoordinate Organosilicates	127
Mechanisms of Nucleophilic Substitution Reactions at Silicon	130
Fluoride Ion Activation of Silicon Bonds in Organic Synthesis	135
Fluoride Activation of the Si-O Bond	137
Fluoride Activation of the Si-H Bond	140
Fluoride Activation of the Si-C Bond	141
Results and Discussion	145
Background	145
Cyanide Displacements Utilizing Hypercoordinate Cyanosilicate	153
Exploration of the Use of Catalytic Amounts of Fluoride	157
Investigation of Alternative Fluoride Sources	160
Proposed Mechanism	161
Conclusions	170
Epilogue	170
Experimental	175
References	191

LIST OF TABLES

Chapter 1

Table 1.	Synthesis of Aryl(trialkoxo)silanes <i>via</i> Treatment of Aryl Grignard or Lithium Reagents with Silicon Electrophiles: Review of the Literature to Date.	45
Table 2.	Optimization of the Synthesis of Arylsiloxanes Using 4-Bromomagnesium Anisole.	46
Table 3.	Synthesis of Aryl(trialkoxo)silanes Using Grignard Reagents.	48
Table 4.	Optimization of the Synthesis of Arylsiloxanes Using 4-Lithiotoluene.	51
Table 5.	Synthesis of Aryl(trialkoxo)silanes Using Lithium Reagents.	53
Table 6.	Optimization of the Silylation of 4-Bromoanisole.	61
Table 7.	Silylation of Aryl Bromides.	62
Table 8.	Silylation of Heteroaryl Bromides.	63
Table 9.	Silylation of Aryl Bromides: Effect of Substituent Position.	64
Table 10.	Palladium-Catalyzed Silylation of Aryl Iodides.	66
Table 11.	Silylation of Aryltriflate Derivatives.	69
Table 12.	Silylation of Arylhalides Using Hexamethoxydisilane.	74

Chapter 2

Table 1.	Comparison of Atomic Properties of Si and C.	123
Table 2.	Atomic and Group Allred-Rochow Electronegativities.	124
Table 3.	Approximate Average Bond Dissociation Energies and Bond Lengths for Tetracoordinate C and Si.	123
Table 4.	Comparison of NMR Data for Tetracoordinate and Pentacoordinate Silicates.	130
Table 5.	Reactivity of a Series of Fluorosilicate Complexes in the Fluorination of 1-Bromododecane at 85 °C.	147
Table 6.	Reaction of Hypercoordinate Silicate 5 with Alkyl Halides.	154
Table 7.	Reaction of Benzyl Bromide (64) with Trimethylsilyl Cyanide (3) and Varying Amounts of TBAF.	158

Table 8.	Reaction of Benzyl Bromide (64) and Trimethylsilyl Cyanide (3) with Tetrabutylammonium Nucleophiles.	159
Table 9.	Reaction of Benzyl Bromide (64) and Trimethylsilyl Cyanide (3) with Alternative Fluoride Sources.	160
Table 10.	Reaction of Secondary Alkyl Halides with Trimethylsilyl Cyanide (3) and TBAF or TBAT (1).	161
Table 11.	Comparison of Nitrile Synthesis Using Trimethylsilyl Cyanide (3)/TBAF or Tetrabutylammonium Cyanide (89).	163
Table 12.	²⁹ Si-NMR Spectral Data for Authentic Samples Used In Mechanistic Studies.	166

LIST OF FIGURES

Chapter 1

Figure 1.	Silicon-Based Aryl Group Transfer Reagents.	2
Figure 2.	Hypercoordinate Aryl Group Transfer Reagents.	3
Figure 3.	Biaryl Natural Product Targets.	7
Figure 4.	Model System For the Synthesis of Colchicine: Fitzgerald's Compound (23)	8
Figure 5.	Natural Product Targets Featuring the 2,4-Arylpyridine Moiety.	11
Figure 6.	Siloxane Derivatives for Application in Natural Product Syntheses.	17
Figure 7.	Biaryl Compounds Synthesized Using the Phenyl(trimethoxy)silane Cross-Coupling Methodology.	18
Figure 8.	Silicon-Based Aryl Group Transfer Reagents.	31
Figure 9.	Siloxanes Prepared <i>via</i> the Grignard Reaction for Use in Natural Product Syntheses.	50
Figure 10.	Complexes Formed in the Silylation of Pyridinyl Metal Reagents.	55
Figure 11.	5-Indole Siloxanes Prepared from Aryllithium Reagents for Use in Natural Product Syntheses.	56
Figure 12.	Proposed Effect of Substituent Position.	65
Figure 13.	Proposed Transition States for the Metathesis Reaction Mechanism.	72
Figure 14.	Yields of Siloxanes Using Arylmetaloid Reagents or Palladium-Mediated Silylation.	78
Figure 15.	Siloxane Intermediates for Use In Natural Product Syntheses..	79

Chapter 2

Figure 1.	Hybridization of Tetra-, Penta-, and Hexacoordinate Silicon.	125
Figure 2.	Comparison of Rates of Expansion of Coordination.	126
Figure 3.	Increase in Silicate Stability Due Chelating Ligands.	128
Figure 4.	Reaction Coordinates for Single-Step and Two-Step Substitution Processes.	133
Figure 5.	Angle of Attack by Nucleophiles on Silanes.	135
Figure 6.	Triphenylsilyl Cyanide (93) and TBAF (1 equiv), ²⁹ Si Spectrum.	167

LIST OF SCHEMES

Chapter 1

Scheme 1	1
Scheme 2	2
Scheme 3	3
Scheme 4	4
Scheme 5	5
Scheme 6	5
Scheme 7	5
Scheme 8	6
Scheme 9	7
Scheme 10	9
Scheme 11	9
Scheme 12	10
Scheme 13	10
Scheme 14	12
Scheme 15	12
Scheme 16	13
Scheme 17	14
Scheme 18	15
Scheme 19	15
Scheme 20	16
Scheme 21	19
Scheme 22	20
Scheme 23	20
Scheme 24	21
Scheme 25	22

Scheme 26	23
Scheme 27	23
Scheme 28	24
Scheme 29	24
Scheme 30	25
Scheme 31	25
Scheme 32	26
Scheme 33	27
Scheme 34	27
Scheme 35	28
Scheme 36	28
Scheme 37	29
Scheme 38	30
Scheme 39	32
Scheme 40	32
Scheme 41	33
Scheme 42	33
Scheme 43	34
Scheme 44	34
Scheme 45	35
Scheme 46	36
Scheme 47	36
Scheme 48	37
Scheme 49	37
Scheme 50	38
Scheme 51	39
Scheme 52	40
Scheme 53	41

Scheme 54	47
Scheme 55	49
Scheme 56	50
Scheme 57	54
Scheme 58	56
Scheme 59	57
Scheme 60	59
Scheme 61	67
Scheme 62	70
Scheme 63	70
Scheme 64	71
Scheme 65	72
Scheme 66	73
Scheme 67	73
Scheme 68	75
Scheme 69	75
Scheme 70	76
Scheme 71	77
Scheme 72	80

Chapter 2

Scheme 1	119
Scheme 2	119
Scheme 3	120
Scheme 4	120
Scheme 5	127
Scheme 6	131
Scheme 7	131

Scheme 8	132
Scheme 9	133
Scheme 10	134
Scheme 11	136
Scheme 12	137
Scheme 13	138
Scheme 14	138
Scheme 15	139
Scheme 16	139
Scheme 17	139
Scheme 18	140
Scheme 19	140
Scheme 20	141
Scheme 21	141
Scheme 22	142
Scheme 23	142
Scheme 24	143
Scheme 25	144
Scheme 26	146
Scheme 27	148
Scheme 28	148
Scheme 29	149
Scheme 30	150
Scheme 31	151
Scheme 32	152
Scheme 33	157
Scheme 34	158
Scheme 35	162

Scheme 36	164
Scheme 37	164
Scheme 38	165
Scheme 39	168
Scheme 40	168
Scheme 41	169
Scheme 42	171
Scheme 43	171
Scheme 44	172
Scheme 45	173

LIST OF ABBREVIATIONS

18-crown-6	1,4,7,10,13,16-Hexaoxacyclooctadecane
Ac	acetyl
ap	apical
aq.	aqueous
Ar	aryl
Bn	benzyl
BOC	<i>t</i> -butyloxycarbonyl
BTAF	benzyl(trimethyl)amino fluoride
Bu	butyl
Bz	benzoyl
cat	catecholate
cod	cyclooctadienyl
cy	cyclohexyl
dba	dibenzylideneacetone
DBU	1,8-diazabicyclo[5.4.0]undec-7-ene
DDQ	2,3-dichloro-5,6-dicyano-1,4-benzoquinone
DIEA	<i>N,N</i> -diisopropylethylamine
DMAP	4-dimethylaminopyridine
DMF	<i>N,N</i> -dimethylformamide
DMSO	dimethyl sulfoxide
DOM	directed ortho metallation
dppf	1,1'-bis(diphenylphosphino)ferrocene
dppp	1,3-bis(diphenylphosphino)propane
EDG	electron donating group
ee	enantiomeric excess
eq	equatorial
equiv	equivalent (s)

Et	ethyl
Et ₂ O	diethyl ether
EWG	electron withdrawing group
γ	gyromagnetic ratio
G. C.	gas chromatograph
h	hour(s)
HMPA	hexamethylphosphoramide
HOMO	highest-occupied molecular orbital
Hz	Hertz
<i>i</i> -Pr	isopropyl
IR	infrared
<i>J</i>	coupling constant
L _n	ligand
LUMO	lowest-unoccupied molecular orbital
<i>m</i>	<i>meta</i>
M ⁺	molecular ion
<i>m/z</i>	mass-to-charge ratio
Me	methyl
MeCN	acetonitrile
MEM	2-methoxyethoxymethyl
MHz	megahertz
min	minute(s)
MOM	methoxymethyl
mp	melting point
MS	mass spectrometry
Ms	methanesulfonyl
Naph	naphthyl
NMP	1-methyl-2-pyrrolidinone

NMR	nuclear magnetic resonance
<i>o</i>	<i>ortho</i>
OAc	acetate
<i>p</i>	<i>para</i>
Ph	phenyl
Pr	propyl
pyr	pyridinyl
PZ	phosphazanium
R_f	retardation factor
rt	room temperature
SET	Single-electron transfer
S_N1	substitution nucleophilic unimolecular
S_N2	substitution nucleophilic bimolecular
<i>t</i> -Bu	tertiary butyl
T_1	spin-lattice relaxation time
TAS-F	tris(dimethylamino)sulfur(trimethylsilyl)difluoride
TBAF	tetrabutylammonium fluoride
TBAT	tetrabutylammonium triphenyldifluorosilicate
TBP	trigonal bipyramidal
Tf	trifluoromethanesulfonyl
THF	tetrahydrofuran
TLC	thin layer chromatography
TMS	trimethylsilyl
tol	tolyl
UV	ultraviolet

Chapter 1. Improved Synthesis of Aryl(triethoxy)silanes for Use in Palladium-Mediated Cross-Coupling Reactions

Introduction

Significance of Aryl(trialkoxo)silanes

The metal-catalyzed cross-coupling reaction for the formation of carbon-carbon bonds between unsaturated centers is an indispensable synthetic tool for the preparation of useful industrial¹ and pharmaceutical²⁻⁹ materials. Of the many combinations of organometallic nucleophiles and organic electrophiles in the literature,¹⁰⁻¹² the Stille (organostannane) and Suzuki (organoborane) coupling methodologies are the most widely employed for the synthesis of unsymmetrical biaryl derivatives and substituted alkenes due to the generally excellent yields, high stereoselectivities, and superior functional group tolerance (Scheme 1).¹²⁻²⁰ Nonetheless, arylsilane derivatives have emerged as powerful alternatives to conventional arylmetaloids for the Pd(0)-catalyzed aryl-aryl coupling reaction with organohalides and organo(pseudo)halides because they avoid the inherent limitations associated with traditional methodologies: the Stille tin reagents and byproducts are toxic; and the Suzuki boron reagents can be difficult to synthesize and purify.^{8,21-59}

Scheme 1

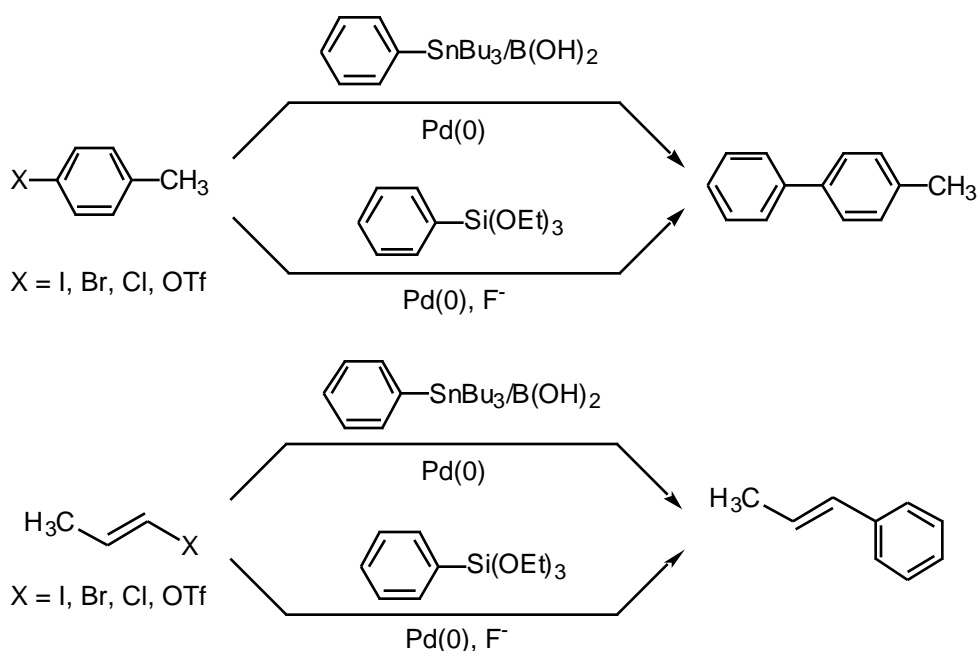

Previous studies from our group²¹⁻²⁵ as well as Hiyama,^{8,26-33} Ito,^{34,35} Denmark,³⁶⁻⁴⁴ and others⁴⁵⁻⁵⁶ have shown that a variety of silicon derivatives (i.e., compounds **1-4**, Figure 1) undergo fluoride-mediated, Pd(0)-catalyzed aryl group transfer reactions.⁵⁷⁻⁵⁹

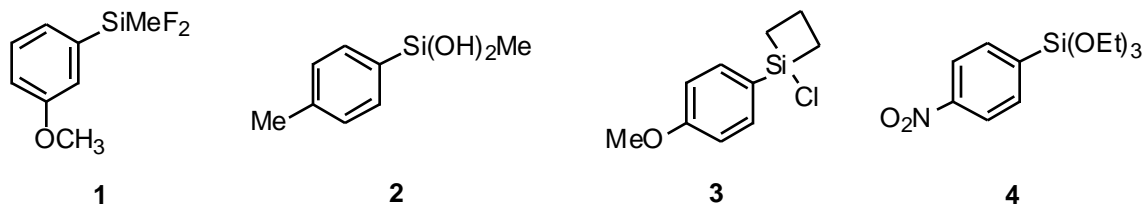
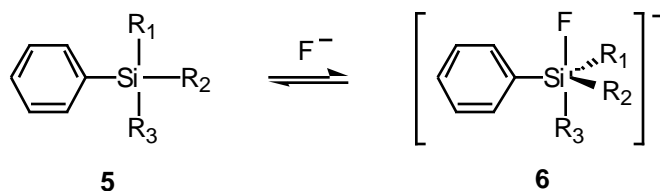

Figure 1. Silicon-Based Aryl Group Transfer Reagents.

Each of the above silicon compounds participates in the Pd-catalyzed cross-coupling reaction only upon activation by a nucleophile, typically fluoride ion. The mechanism of action of these silicon reagents is similar. As illustrated in Scheme 2, the process is proposed to involve the *in situ* formation of the reactive hypercoordinate intermediate **6** by attack of fluoride on the tetracoordinate aryl silicon reagent **5**.^{9,53,54} Conversion of the neutral tetracoordinate silane **5** to anionic hypercoordinate silicate **6** both lengthens and polarizes the silicon-ligand bonds, placing a large partial positive charge on silicon and a large partial negative charge on the arene and the other ligands.⁶⁰⁻⁶²

Scheme 2



The overall catalytic cycle for aryl-aryl coupling begins with formation of Pd(II) species **7** as a result of oxidative addition of Pd(0) into the aryl-X bond of the aryl halide substrate (Scheme 3). As described above, unlike the weakly polarized tetracoordinate precursor **5**, the anionic hypercoordinate fluorosilicate **6** undergoes transmetalation with palladium complex **7** to form the bis-aryl Pd(II) species **9**, with loss of R₃SiFX⁻ (**8**). Lastly, reductive elimination of Pd(0) regenerates the catalyst, and liberates the biaryl product.

Scheme 3

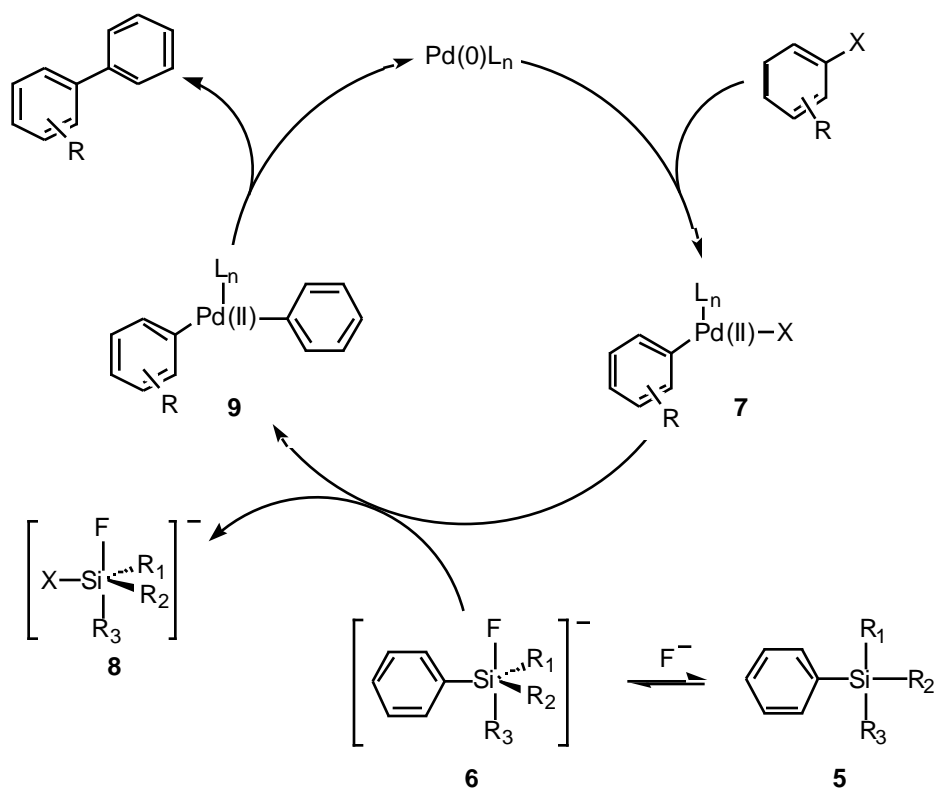

The most compelling evidence of the participation of a hypercoordinate silicate intermediate such as **6** is the ability of analogous *isolable* organosilicates to participate in the cross-coupling reaction in the absence of additional fluoride. Silicates **10** and **11** have been shown to be effective phenylating²² and vinylating⁶³⁻⁶⁵ reagents, respectively (Figure 2). In addition, catecholates derivatives such as **11** have been employed for the transfer of other groups, for example alkenyl and aryl moieties.⁶⁵⁻⁶⁸

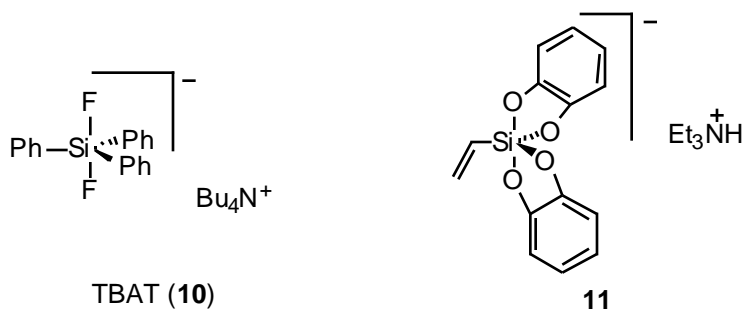
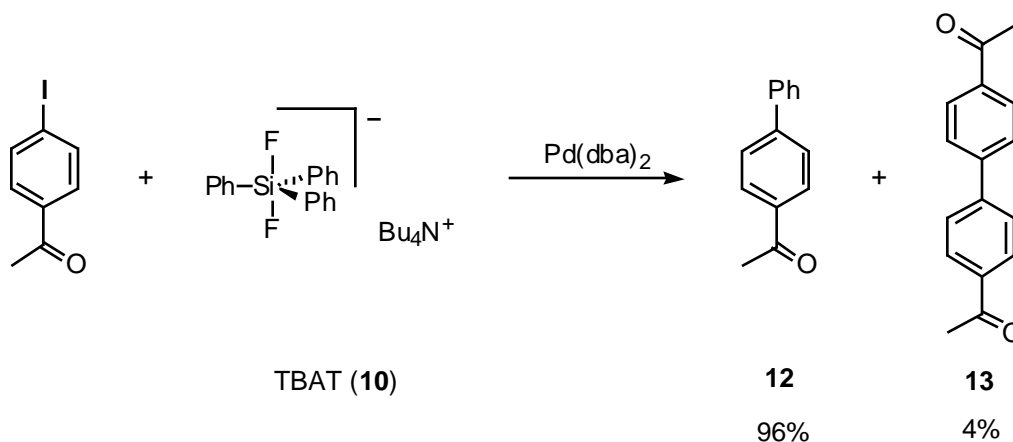

Figure 2. Hypercoordinate Aryl Group Transfer Reagents.

The initial studies in the DeShong laboratories concerning the cross-coupling reactions of silicon reagents employed compound **10**, tetrabutylammonium triphenyldifluorosilicate ($[\text{Ph}_3\text{SiF}_2][\text{Bu}_4\text{N}]^+$, TBAT).^{22,67} Under palladium catalysis, good yields of coupled products were obtained with aryl iodides, most aryl triflates, and electron-deficient aryl bromides (Scheme 4). In addition to forming the desired heterocoupled product **12**, small amounts of homocoupled product **13** were also isolated.²² The major limitations of the TBAT cross-coupling methodology are (1) poor atom economy (under standard reaction conditions only one phenyl group out of three is transferred); and (2) substituted difluorotriaryl analogs of **10** are not easily synthesized.⁶⁷

Scheme 4



In an effort to overcome the limitations associated with TBAT, phenyltrimethoxysilane (**15**, Scheme 5) was investigated as a less wasteful, and more easily derivatized arylating reagent.^{21,23-25} Siloxane derivatives such as **15** are non-toxic, hydrolytically stable compounds, whose synthesis and characterization have been reported most notably in the fields of polymer and materials chemistry.^{69,70} Recently, the DeShong research group described the synthesis of unsymmetrically substituted biaryls *via* phenylation of aryl iodides,^{21,24} bromides and chlorides^{23,24} with commercially available phenyltrimethoxysilane (**15**). For example, 2-bromopyridine (**14**) was cross-coupled with phenyltrimethoxysilane (**15**) to form biaryl **16** in 76% isolated yield (Scheme 5).²³

Scheme 5

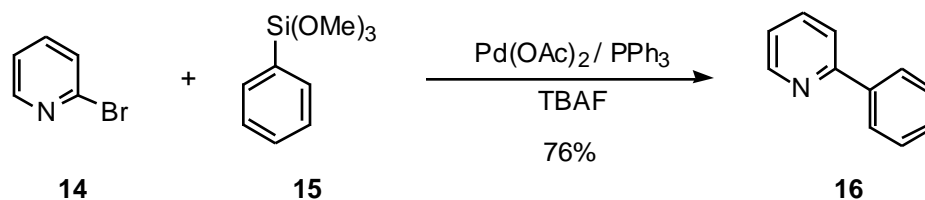

In congruence with the general mechanism depicted in Scheme 3, the assumed reactive silicon species is hypercoordinate fluorosilicate **17** (Scheme 6).^{21,67}

Scheme 6

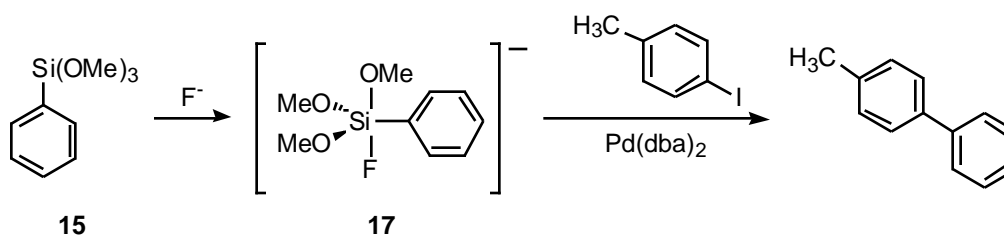

Recent efforts have focused on the cross-coupling reaction of arylsiloxane derivatives with aryltriflate substrates. Aryl triflates, readily derived from the phenol,⁷¹ are often more available than the corresponding aryl halides; however, siloxanes have failed to undergo efficient cross-coupling with aryl triflates (Scheme 7). Under standard cross-coupling conditions, the base TBAF induces triflate hydrolysis by liberating methoxide from the siloxane starting material. Preliminary studies indicate that hydrolysis can be mitigated by the addition of water, which presumably dilutes and solvates the offending alkoxide.⁷²

Scheme 7

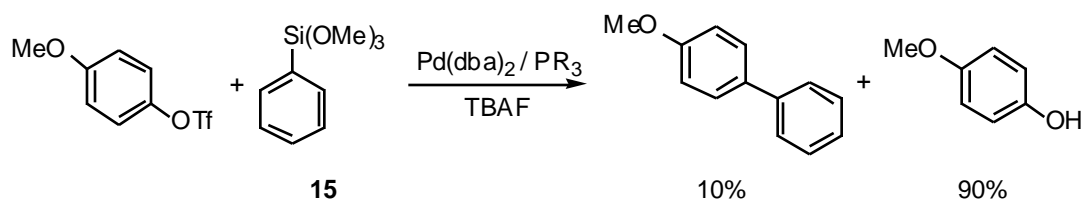

Very recently, siloxane derivatives bearing chelating alkoxy ligands were found to undergo Pd-catalyzed cross-coupling with aryl and heteroaryl triflates in the presence of a fluoride source in good to excellent yields.^{68,72} It is proposed that the alkoxide ligands are stabilized by the chelate effect, thereby attenuating triflate hydrolysis. Triethylammonium (bis)catechol phenyl silicate ($[\text{PhSi}(\text{cat})_2][\text{Et}_3\text{NH}]^+$, **18**) and phenyl silatrane (**19**) derivatives are synthesized in high yield from the corresponding trialkoxysilane *via* transesterification to form crystalline, air and moisture stable complexes (Scheme 8). The stability of compounds **18** and **19** to hydrolysis and alcoholysis is well established.⁷³⁻⁷⁹

Scheme 8

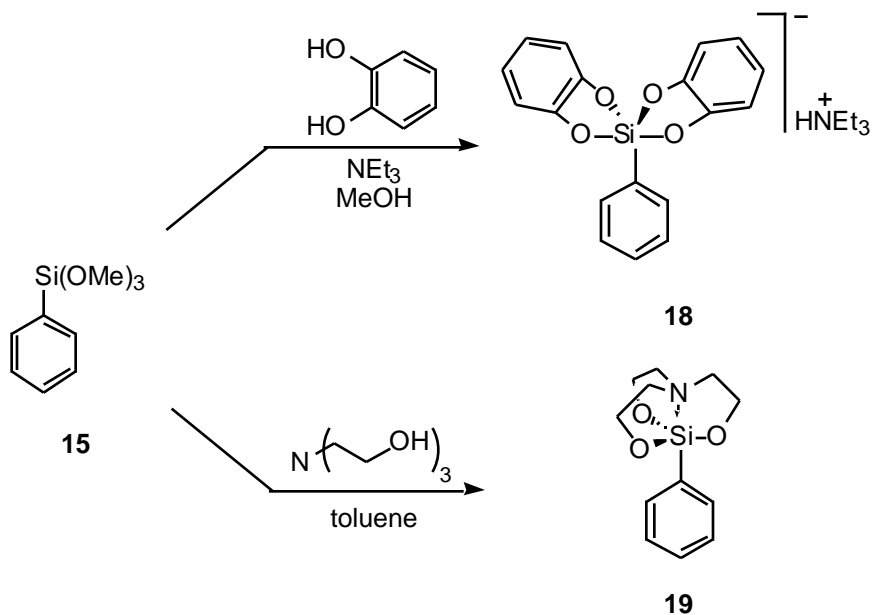

Silicates **18** and **19** were found to participate in the fluoride-activated, Pd-mediated cross-coupling reaction with aryl iodides, bromides and most notably triflates.^{68,72} The reaction tolerates a wide range of electron-withdrawing and electron-releasing substituents, as well as heteroaromatic systems. For example, aryl triflate **20** was cross-coupled with catecholate **18** to form biaryl **21** in 96% isolated yield (Scheme 9).

Scheme 9

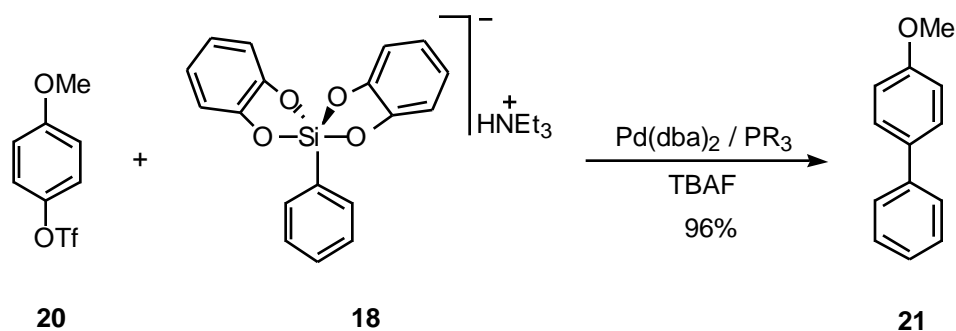

Synthesis of Natural Products Using Aryl(trialkoxy)silane Derivatives

To further demonstrate the generality of the hypercoordinate silicate cross-coupling reaction, preliminary studies are underway to apply this technique to the synthesis of complex biaryl natural products. Targets include the anti-inflammatory and anti-mitotic drugs colchicine (**22**),^{80,81} and Fitzgerald's compound (**23**)⁸² and the antitumor 2-quinoline-2-pyridyl derivatives streptonigrin (**24**),^{83,84} and lavendamycin (**25**) (Figure 3).^{85,86}

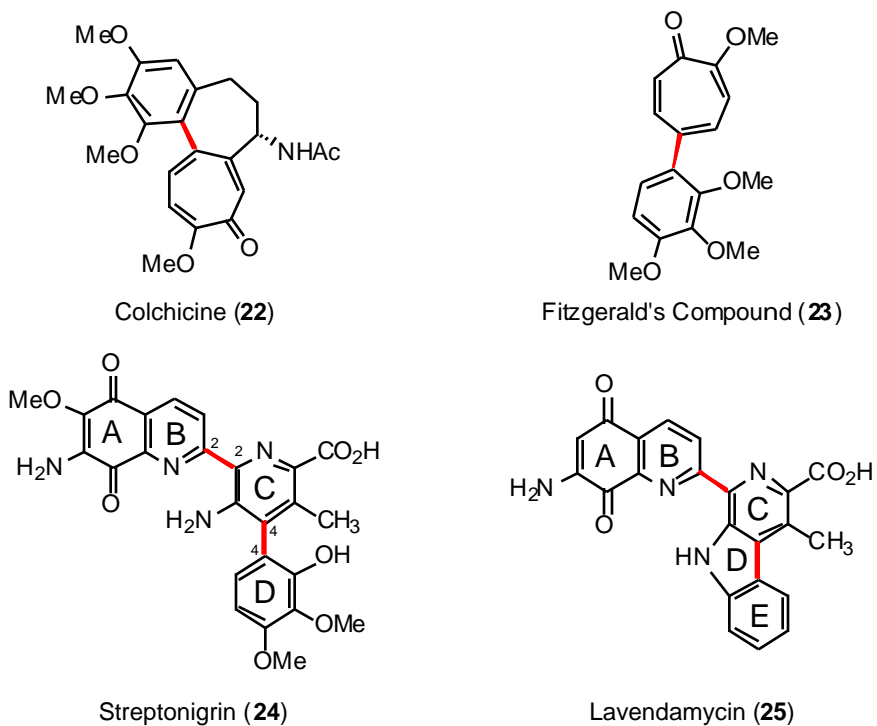
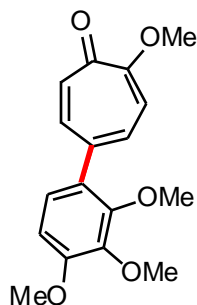

Figure 3. Biaryl Natural Product Targets.

Each of these natural product syntheses will have as the key biaryl carbon-carbon bond forming step a silicon-based cross-coupling reaction. This, in turn, will necessitate the synthesis of highly functionalized aryl(trialkoxy)silane and aryl halide coupling partners. The biaryl skeletons of colchicine,⁸⁷⁻⁹⁷ Fitzgerald's compound,⁹⁸ streptonigrin⁹⁹⁻¹⁰¹ and lavendamycin¹⁰²⁻¹⁰⁹ have been synthesized previously by classical Stille and Suzuki cross-coupling methodologies; for each target, the previously reported synthetic approach will serve as a standard for our synthetic plan.

Colchicine (**22**) is a commonly prescribed drug for the treatment of gout.⁸⁰ This alkaloid has more recently been found to have taxol-like antitumor properties, in that it binds to β -tubulin preventing cellular spindle formation and division.⁸¹ As a synthetic target, the colchicine skeleton was particularly intriguing to the DeShong group: the siloxane cross-coupling methodology had never before been used for the formation of carbon-carbon bonds between arenes and alternative aromatic systems, such as the tropolone moiety.

Approaches to the synthesis of colchicine (**22**) in our laboratories have focused on 5-(trimethoxyphenyl)tropolone methyl ether (Fitzgerald's compound, **23**, Figure 4) as a model system for the formation of the aryl-tropolone bond. The synthesis of **23** is a worthwhile endeavor in its own right because Fitzgerald's compound displays anti-mitotic properties comparable to those of colchicine.⁸²



Fitzgerald's Compound (**23**)

Figure 4. Model System For the Synthesis of Colchicine: Fitzgerald's Compound (**23**).

Compound **23** was prepared in excellent yield by Banwell through a Suzuki reaction employing 5-bromotropolone methyl ether (**26**) and the trisubstituted aryl boronic acid **27** (Scheme 10).⁹⁸ It is noteworthy that attempts to synthesize compound **23** and simpler analogs *via* the Stille method consistently gave lower yields than the corresponding Suzuki approach. Aryl boronic acids remain the reagent of choice for the formation of the aryl-tropolone bond.^{98,110} In most cases, failure of the Stille reaction to provide the cross-coupled adduct was attributed to steric hindrance by the methoxy substituent *ortho* to the desired aryl-tropolone bond.

Scheme 10

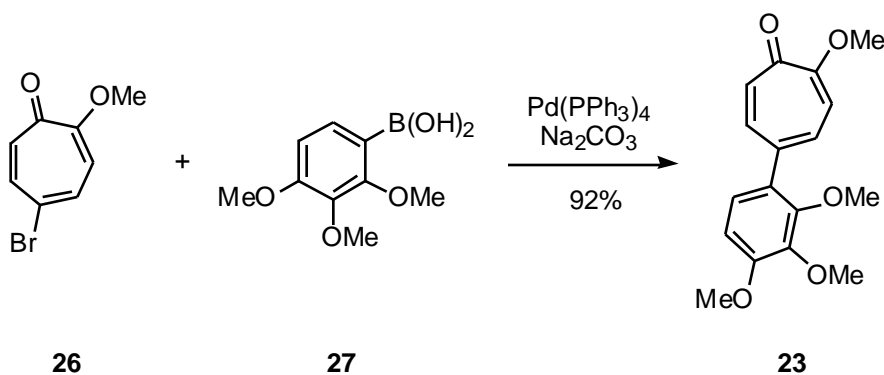

A similar tactic is proposed for the synthesis of **23** *via* the siloxane cross-coupling technology (Scheme 11). This approach requires the synthesis of complex aryl siloxane derivative **28**; bromotropolone **26** has been prepared previously.⁹⁸

Scheme 11

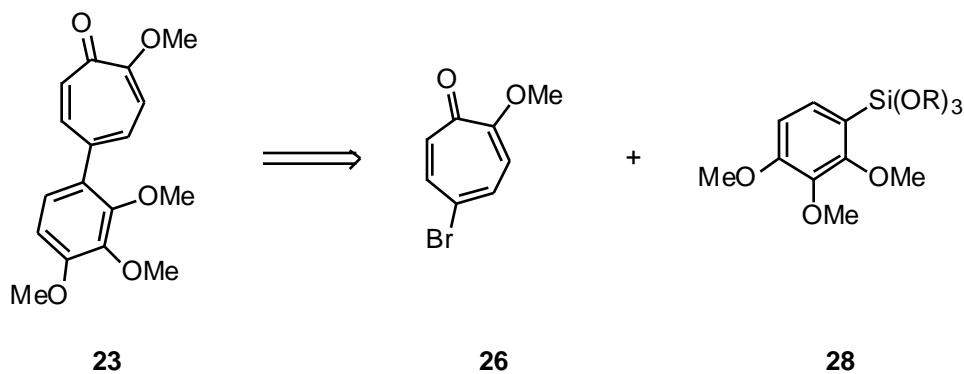

Handy¹¹¹ and Seganish⁶⁸ in the DeShong laboratories have probed the viability of using silicon-based reagents for the formation of the phenyl-tropolone bond *via* Pd(0)-catalyzed cross-coupling. To alleviate the steric demand on the cross-coupling of hindered siloxane **28** (Scheme 11), the simple phenylation of tropolone derivatives was investigated (Scheme 12). Handy demonstrated that MEM-protected bromotropolone **29** was unreactive to cross-coupling with phenyltrimethoxysilane (**15**) under standard and modified reaction conditions; in all cases, starting material was recovered.¹¹¹

Scheme 12

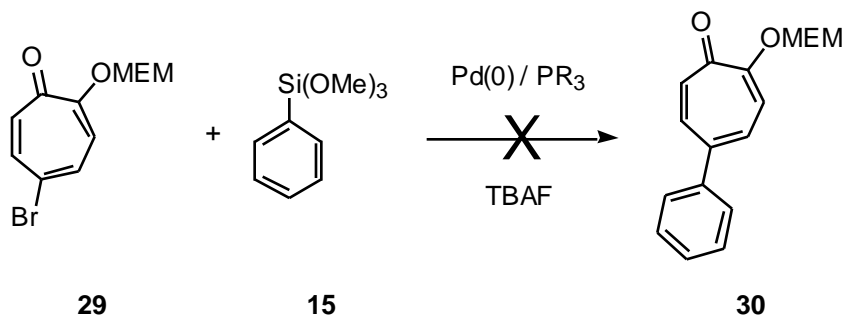

Seganish reported the high yielding phenylation of 2-tropolone trifluoromethanesulfonate (**31**) with triethylammonium (bis)catechol phenyl silicate (**18**).⁶⁸ Seganish continues to explore the use of silicon catecholates for the arylation of substituted tropolone derivatives, with the ultimate goal of completing the total synthesis of colchicine as outlined in Scheme 11.

Scheme 13

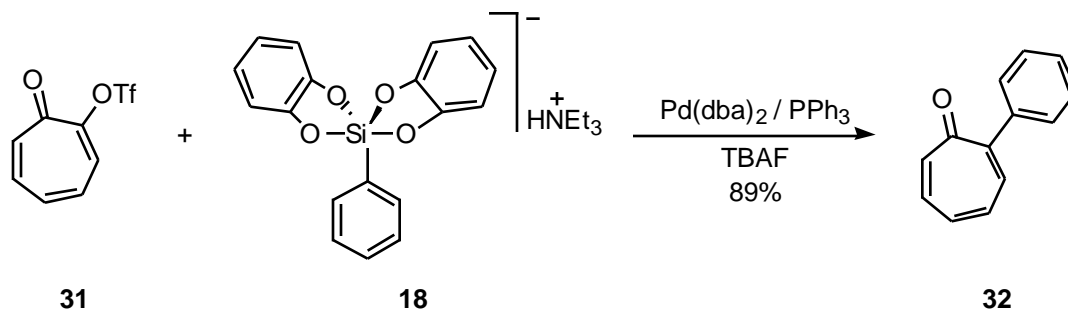

Streptonigrin (**24**)^{83,84} and lavendamycin (**25**)^{85,86} are structurally similar antitumor antibiotics: both have at their core a highly substituted pyridine moiety (ring C), bound at C–2 and C–4 to a functionalized quinone and a substituted arene, respectively (Figure 5). As a synthetic target, this skeleton was of particular interest to the DeShong group: the siloxane cross-coupling methodology had not yet been investigated for the formation of carbon-carbon bonds between two heteroaromatic systems, such as pyridines and quinones. More importantly, our goal was to address a major limitation of the Suzuki reaction, which has been demonstrated to be ineffectual for the cross-coupling of heteroaromatic derivatives.¹¹² Approaches to the synthesis of streptonigrin (**24**) and lavendamycin (**25**) in our laboratories have concentrated on nitramarine (**33**) as a model system for the construction of the 2-quinoline-2-pyridyl systems. In addition, nitramarine and lavendamycin have in common the β -carboline (C–D–E) ring system.

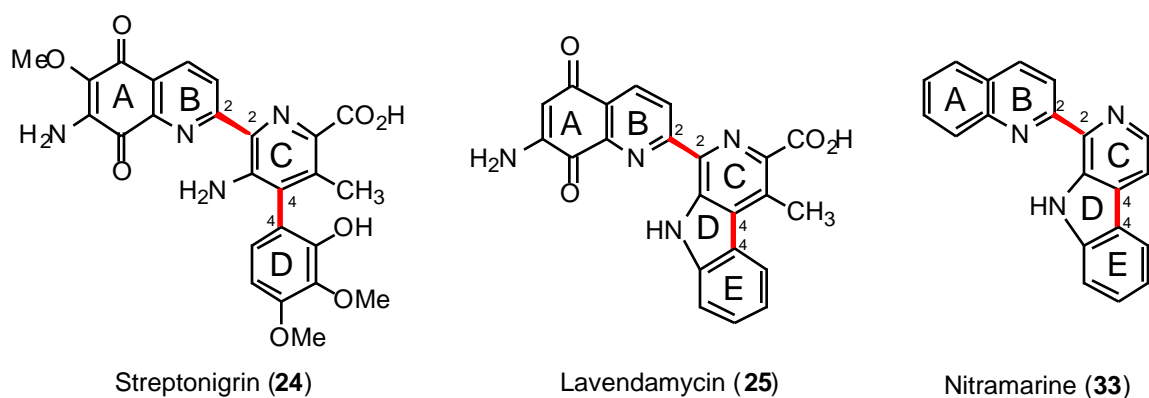
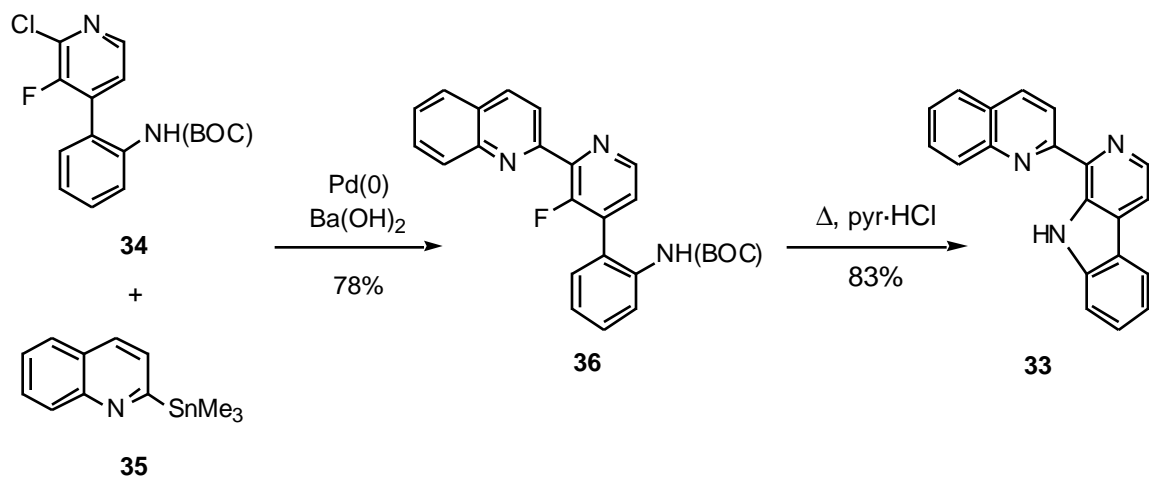

Figure 5. Natural Product Targets Featuring the 2,4-Arylpyridine Moiety.

Focusing on the formation of the quinolinyl-pyridyl (C–2/B–2) bond of nitramarine, compound **33** was prepared in good yield by Queguiner *via* Stille coupling of 2-chloropyridine derivative **34** with 2-(trimethylstannyl)quinoline **35** (Scheme 14); β -carboline ring (ring D) closure of adduct **36** completed the synthesis.¹¹³

Scheme 14



A similar tactic is proposed for the synthesis of **33** via the siloxane cross-coupling technology (Scheme 15). This approach requires the synthesis of the quinoline siloxane **38**; the β -carboline halides and sulfonates (**37**) have been prepared previously.¹¹³ Alternatively, the complex pyridyl siloxane **39** could be prepared and coupled with the quinoline halide or sulfonate (**40**).

Scheme 15

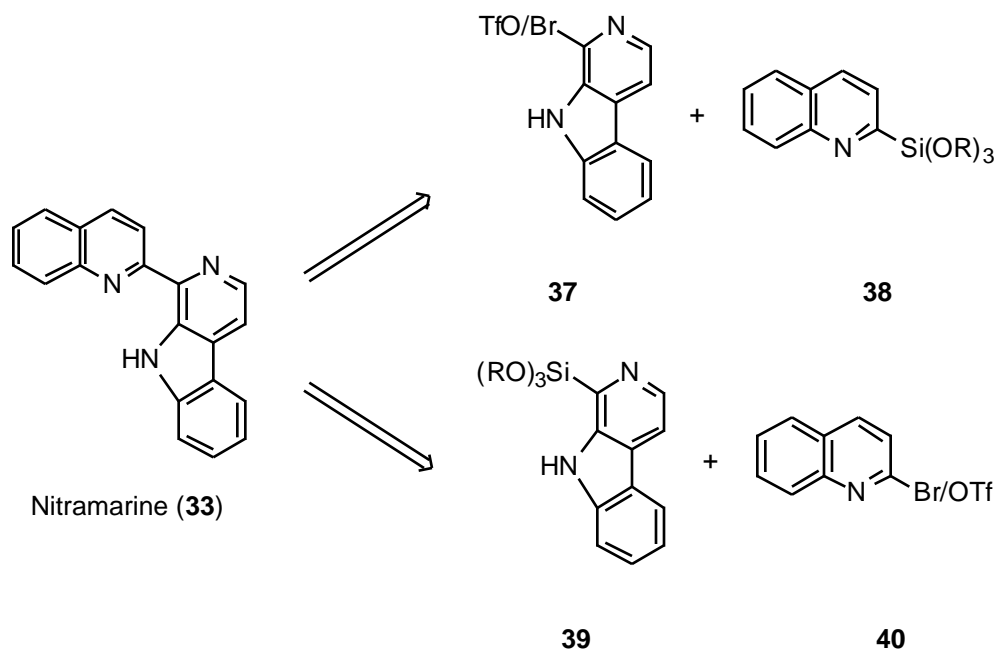

Handy,^{24,111} and Seganish⁶⁸ in the DeShong laboratories have probed the viability of using silicon-based reagents for the formation of the C–2/B–2 bond *via* Pd(0)-catalyzed cross-coupling. For these exploratory studies, the simple phenylation of pyridine and quinoline derivatives was investigated. Mowery had previously shown that 2-bromo and 3-bromopyridine (**41** and **43**) readily underwent phenylation using the fluoride-activated, Pd(0)-catalyzed siloxane methodology (Scheme 16, eqs. a and b).²³ In parallel, 2- and 3-pyridyl triflates were cross-coupled in good yield by Seganish using the catecholate reagent **18** (Scheme 16, eqs. c and d).⁶⁸

Scheme 16

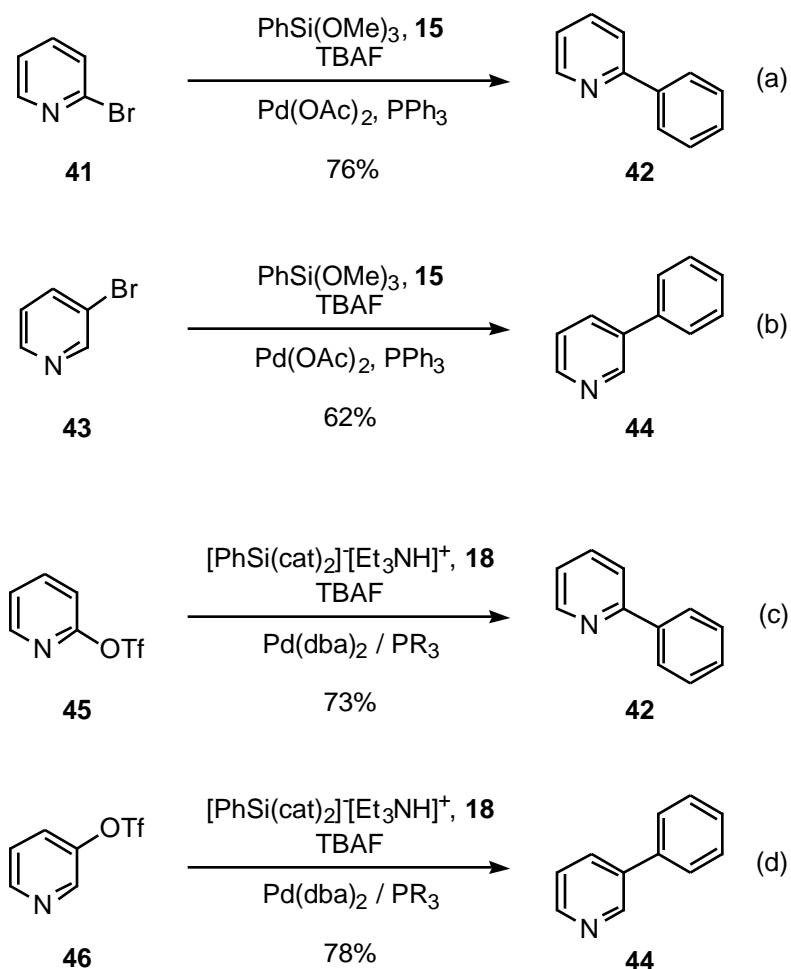

As illustrated in Scheme 17, Handy recently demonstrated the efficient cross-coupling of phenyltrimethoxysilane (**15**) and 2-bromoquinoline (**47**) to form 2-phenylquinoline (**48**, Scheme 17, eq. a).¹¹¹ In turn, 2-quinoline triflate **49** was cross-coupled in excellent yield with (bis)catechol phenyl silicate **21** by Seganish (Scheme 17, eq. b).⁶⁸

Scheme 17

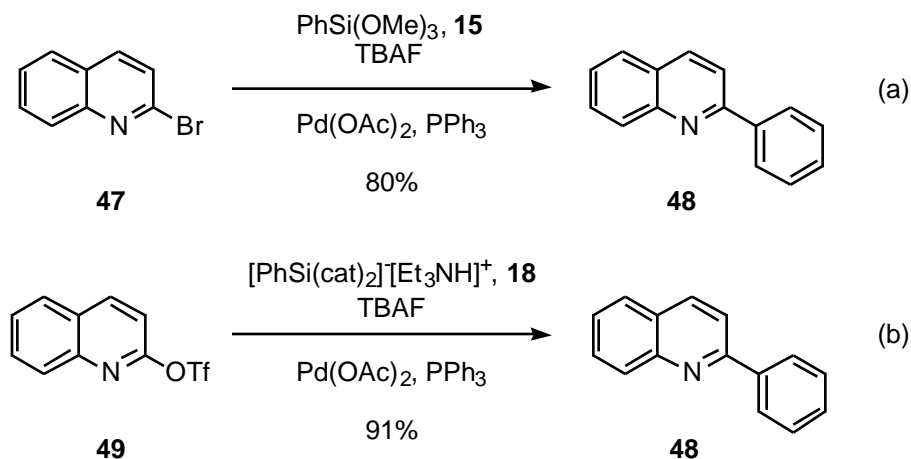

Encouraged by the initial results demonstrating the successful phenylation of simple pyridine and quinoline compounds, efforts are underway to develop the cross-coupling methodology for the formation of the C4–D4 and C2–B2 heteroaryl-heteroaryl bonds present in both streptonigrin (**24**) and lavendamycin (**25**). For streptonigrin, the proposed synthesis will have as its key steps (1) the silicon-based pyridyl-aryl cross-coupling of highly substituted 4-bromopyridine **52** with sterically encumbered arylsiloxane derivative **53**; and (2) the subsequent silicon-based cross-coupling of the complete C–D ring system (**51**) with 2-(trialkoxysilylpyridyl)-5,8-quinone **50** (Scheme 18).¹¹²

Scheme 18

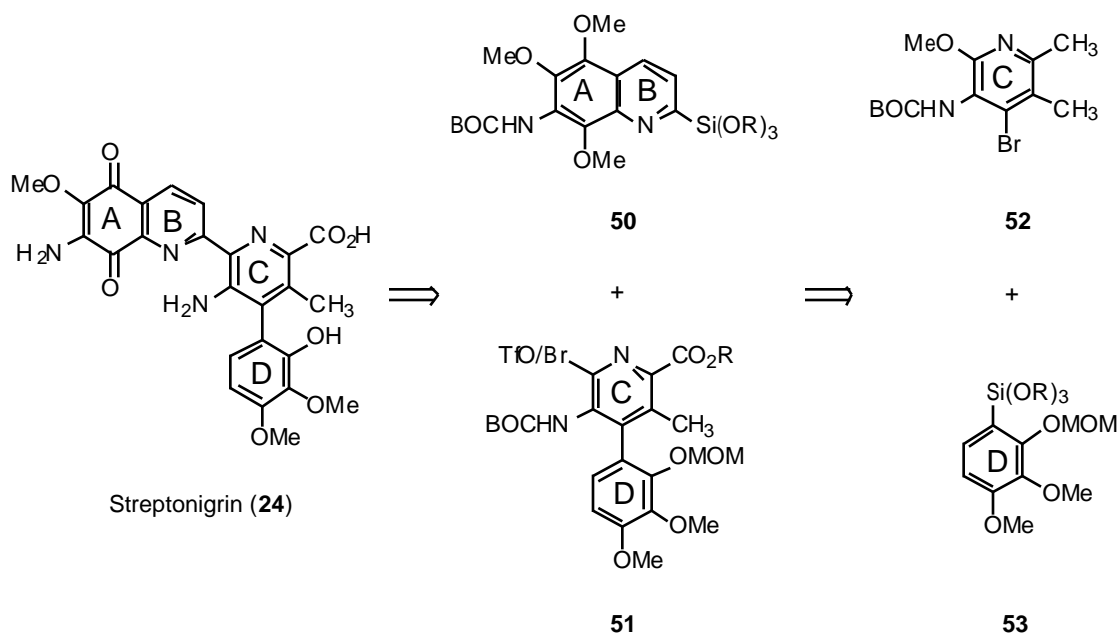

For lavendamycin (**25**), the proposed synthesis will have as its key steps (1) the silicon-based cross-coupling of highly substituted 4-bromopyridine **57** with *ortho*-substituted arylsiloxane derivative **58**; and (2) the subsequent silicon-based cross-coupling of the complete C–D–E ring system (**56**) with 2-(trialkoxysilylpyridyl)-5,8-quinone **55** (Scheme 19).¹¹²

Scheme 19

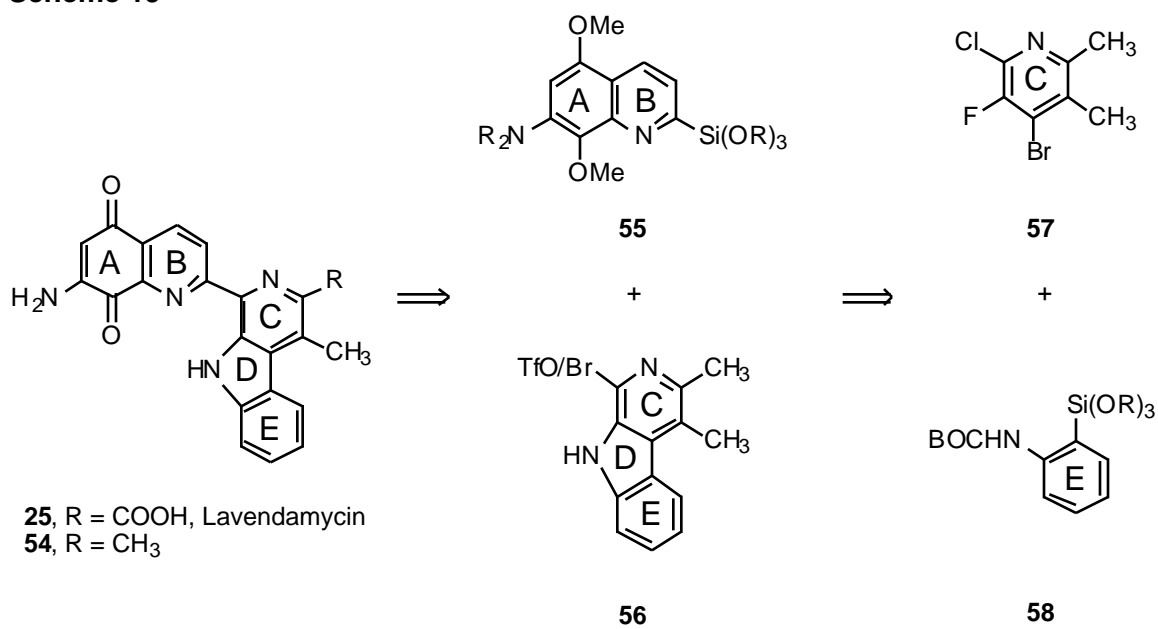

Toward the goal of constructing the C–D ring system (**51**) of streptonigrin, McElroy has extended the scope of Pd-catalyzed siloxane coupling to include the efficient phenylation of functionalized 4-bromopyridines.¹¹² Under palladium catalysis, hindered 4-bromopyridine derivative **59** was cross-coupled in good yield with TBAT (**10**) (Scheme 20, eq. a); however, when phenyltrimethoxysilane and TBAF were employed as the phenylating reagent with electron-deficient substrate **59**, low yields of adduct **60** were obtained. Gratifyingly, electron-rich substrate **61** underwent high yielding phenylation with phenyltriethoxysilane (Scheme 20, eq. b).

Scheme 20

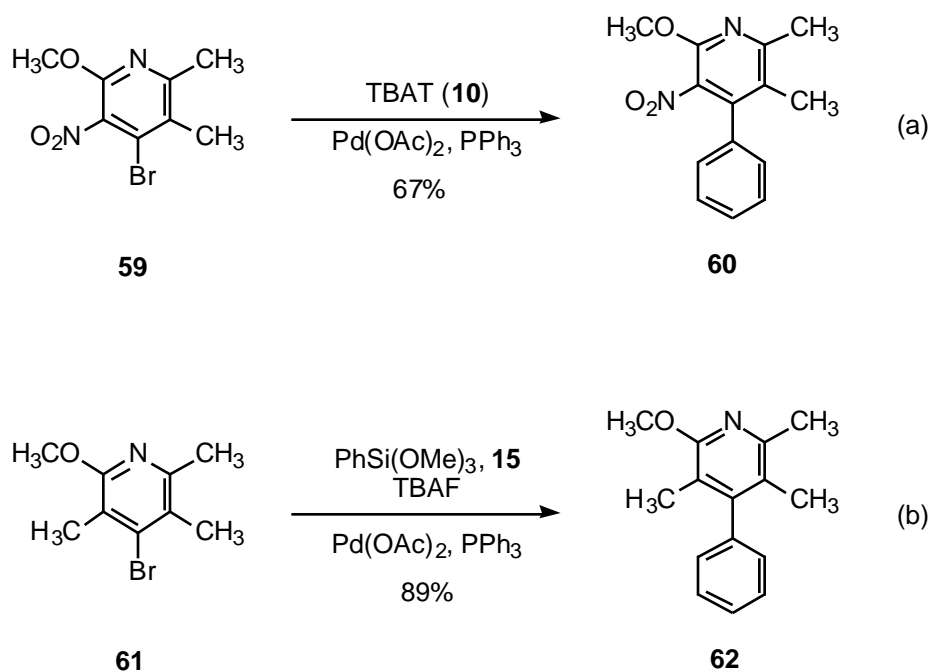

In conclusion, for these proposed natural product syntheses to be successful, a general, efficient synthesis of highly functionalized aryl siloxanes is required. The siloxanes needed for the synthesis of colchicine (**22**), Fitzgerald's compound (**23**), streptonigrin (**24**), lavendamycin (**25**), and nitramarine (**34**) are summarized, in Figure 6.

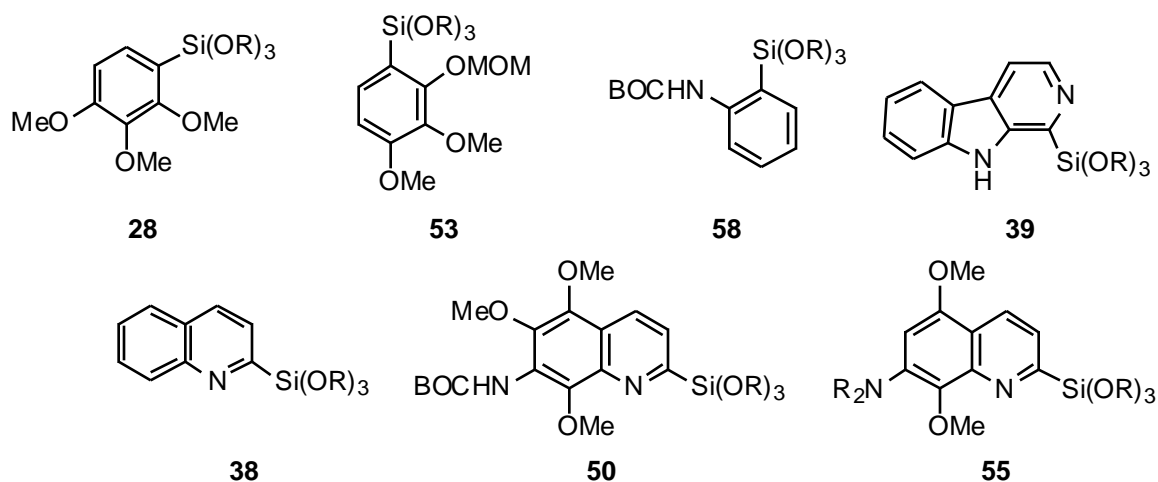

Figure 6. Siloxane Derivatives for Application in Natural Product Syntheses.

To date, the DeShong group has demonstrated the Pd-catalyzed fluoride-activated phenylation by phenyl(trialkoxy)silane derivatives of a range of electron-rich and electron-deficient aryl halides and triflates, including sterically hindered and heteroaromatic substrates.^{21,23-25} A sampling of the biaryl compounds that have been synthesized in our laboratories is shown in Figure 7. The syntheses of heteroatomic, aryloxy, and Lewis basic biaryl derivatives are particularly noteworthy because these types of compounds are difficult to access *via* the corresponding Suzuki reaction: the synthesis and reactions of arylborane reagents in the presence of Lewis basic moieties are often stymied by their interaction with the highly Lewis acidic boron center.

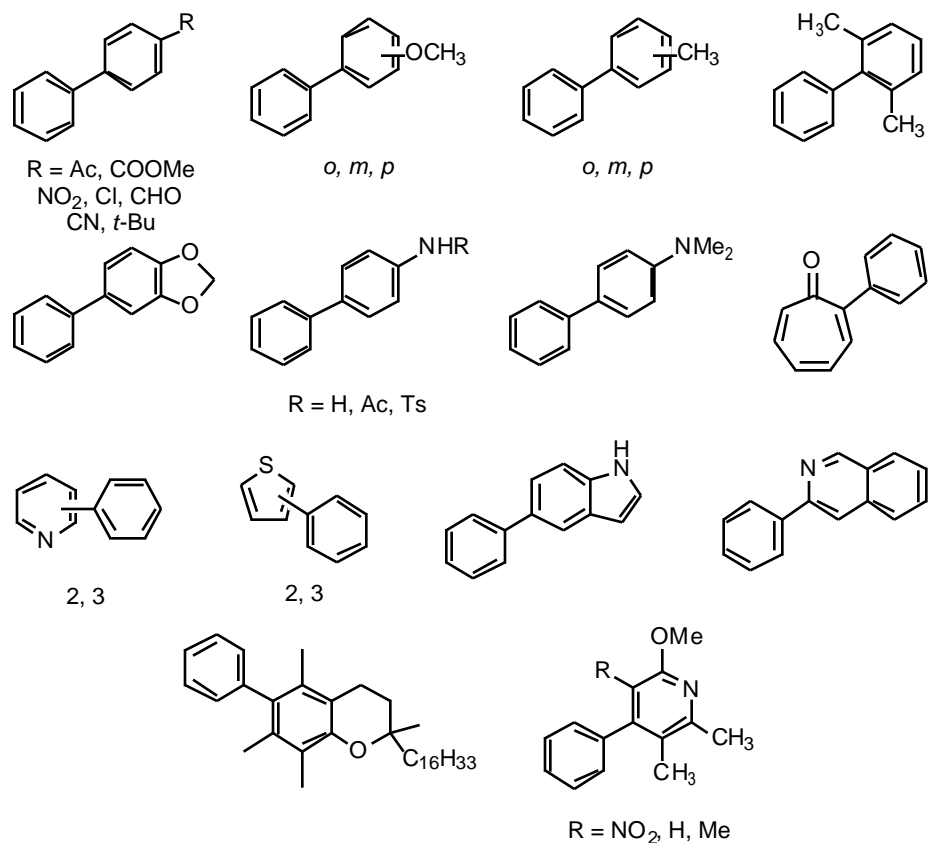

Figure 7. Biaryl Compounds Synthesized Using the Phenyl(trimethoxy)silane Cross-Coupling Methodology.

The research described above has already established the relative mildness, wide ranging functional group compatibility, and ease of work-up of the siloxane-based cross-coupling process for the transfer of phenyl.^{21,23-25} However, until the facility of synthesizing of aryl(trialkoxy)silane derivatives, and the ability of our siloxane methodology to transfer aryl groups other than phenyl has been established, the generality of the siloxane-based cross-coupling methodology remains unproven.⁴¹

Research Goal: Synthesis of Aryl(trialkoxy)silane Derivatives

The goal of the research described herein has been the development and optimization of methods for the synthesis of aryl(trialkoxy)silane reagents. This study necessitated the synthesis of *ortho*, *meta*, and *para*-substituted, electron-rich and electron-deficient aryl siloxanes. Additionally, aryl(trialkoxy)silanes are needed as

precursors to the corresponding aryl(biscatecholate) or arylsilatrane derivatives required for the cross-coupling with aryl triflates. The penultimate goal is the development of methods for the synthesis of complex aryl siloxane intermediates needed for the construction of biaryl natural products.

Scheme 21

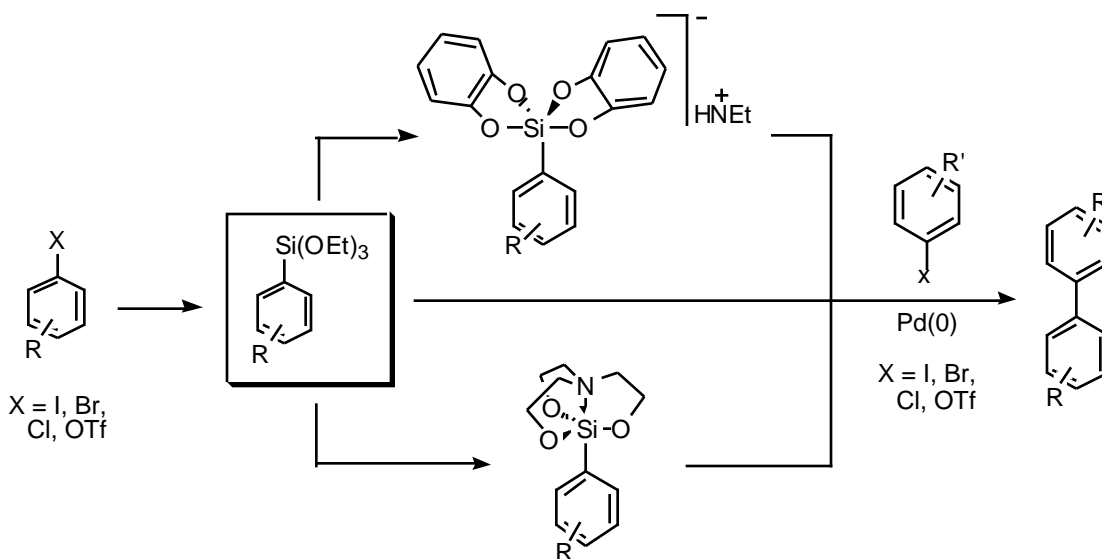

In their dissertations on the Pd-mediated reactions of hypercoordinate silicates, Mowery⁶⁷ and Handy¹¹¹ reviewed the mechanism and scope of the cross-coupling reactions of aryl silicon, boron, and tin reagents. The aim of this chapter is to review existing methods for the synthesis of aryl trialkoxysilane, boron, and tin reagents for use in the Pd-mediated cross-coupling reaction. Finally, the results of studies in the DeShong lab on improved methods for the synthesis of aryl(trialkoxy)silanes are presented and discussed.

Overview of the Synthesis of Aryl Group Transfer Reagents

Focusing on aryl silicon, boron, and tin reagents, two general approaches exist for the synthesis of these materials: (1) the most common and economical method is the treatment of an aryl Grignard or lithium reagent with a silicon, boron or tin electrophile (Scheme 22);

Scheme 22

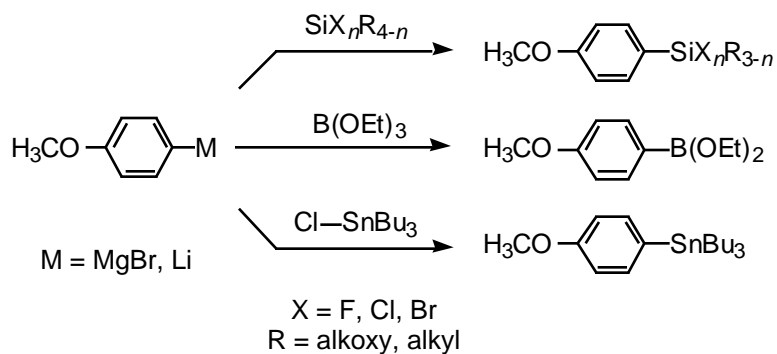

and (2) when an incompatibility with organic functional groups arises, the transition metal-mediated silylation, borylation or stannylation of an aryl halide (*vide infra*) (Scheme 23).¹¹⁴

Scheme 23

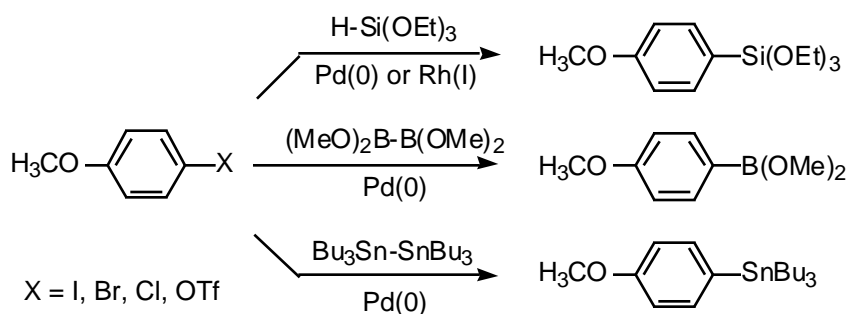

Other miscellaneous methods have been reported, however, the above methods remain the most widely employed pathways to the synthesis of aryl cross-coupling reagents.¹⁰ The availability of multiple methods for the synthesis of any given reagent adds to the versatility and overall strength of the corresponding cross-coupling methodology.

Both approaches (Schemes 22 and 23) have their inherent strengths and limitations.¹⁰ Most notably among their strengths, these methods are regioselective, allowing for the direct installment of the desired tin, boron, or silicon electrophile at the site of the halogen. Metallation—either *via* formation of the aryl Grignard or aryl lithium reagent—is a relatively inexpensive, scalable standard laboratory technique, and the desired arylmetaloid can be generated conveniently, in typically fair to excellent yields using previously reported procedures.¹¹⁵ Subsequent treatment of the aryl metalloid intermediate with a silicon, boron, or tin electrophile gives the desired product in fair to excellent yield, as described below.

That said, the metalloid reaction is limited by the problems associated with the synthesis of aryl metalloids having electrophilic functional groups (i.e. esters, ketones, etc.).¹¹⁶⁻¹²² Also, protic functional groups must be protected prior to metallation. Highly reactive aryllithium species must be generated at low temperature (between -78 and -110 °C), and often decompose before undergoing further transformation. The reaction of multifunctional silicon, boron, or tin electrophiles with highly reactive aryl metalloid derivatives is typically complicated by the formation of polyarylated products (Scheme 24, eq. a).¹²³ In addition, homocoupling of the arylmetaloid can occur, resulting in the formation of biaryl contaminants (eq. b), and lithium-halogen exchange can be complicated by competing alkylation (eq. c).¹¹⁵ This overview will focus on known methods for the preparation of tin, boron, and silicon cross-coupling reagents; methods for the generation of aryl Grignard^{124,125} and lithium¹²⁶⁻¹²⁹ intermediates are reviewed elsewhere.^{115,130}

Scheme 24

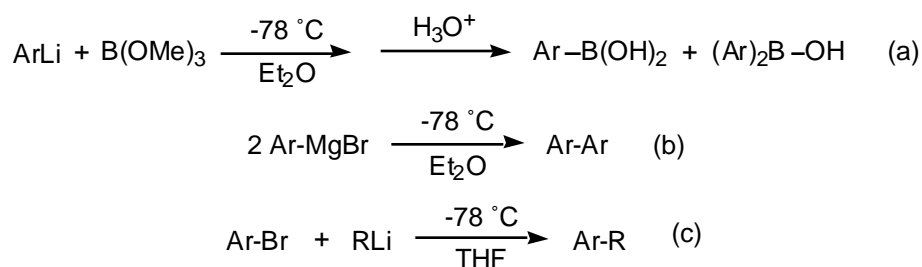

In turn, the Pd-mediated approach summarized in Scheme 23 (above) is relatively expensive and often limited by the lack of generality (*vide infra*); for example, different conditions (catalyst, solvent, base) are typically required for electron-deficient and electron-rich aryl halide substrates. In addition, chloroarenes are notoriously unreactive under typical cross-coupling conditions. Nevertheless, the Pd-mediated approach is an invaluable foil to the organometallic approach, given its relative mildness and functional group tolerance.

Lastly, both methods require an aryl halide starting material: generation of the aryllithium by metal-halogen exchange, the Grignard under standard or Barbier reaction conditions, or the reactive Ar–Pd(II)–X intermediate necessitates the synthesis of the required aryl iodide or bromide precursor (Scheme 25). The regiospecific halogenation of a functionalized aromatic system can be problematic, and often requires multiple steps. Lastly, it is difficult to achieve the regioselective monolithiation of polyhalogenated aromatics; consequently, multiple products—both regio- and polyfunctionalized isomers—are obtained upon the addition of the electrophile.¹²⁶⁻¹²⁹

Scheme 25

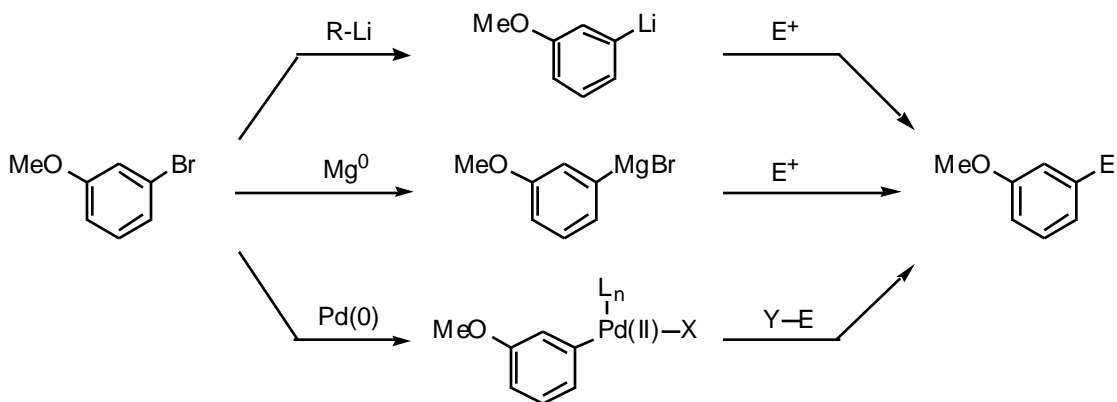

Aryllithium reagents can be generated in the absence of a halogen substituent on the arene substrate by directed *ortho* metallation (DOM).¹³¹⁻¹³⁷ The DOM reaction involves chelation of a lithium transfer reagent to a Lewis basic group; this chelation results in deprotonation and lithiation at a position *ortho* to the directing group (Scheme 26).

Scheme 26

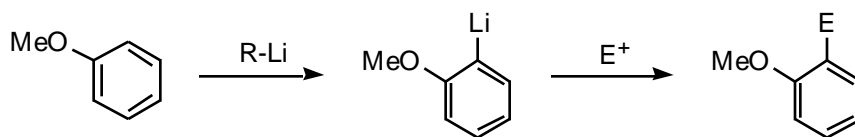

As with lithium-halogen exchange, DOM is a powerful method for the regioselective formation of aryllithium reagents; however, DOM is limited to substrates with a geometrically available heteroatom.¹³² Also, the presence of bulky substituents *meta* to the desired site of lithiation can compromise the regioselectivity of the reaction through steric interference;¹³³⁻¹³⁷ lastly, other substituents on the substrate which are capable of chelation can compete as metal-directing groups. Graduate student Michael Seganish is currently exploring the synthesis of *ortho*-substituted aryl(trialkoxo)silane derivatives utilizing directed *ortho* metallation.

Preparation of Aryl Stille (Tin) Reagents

Despite their toxicity, organotin reagents are prized for their ease of synthesis, handling and storage; they are stable to moisture and oxygen, and can be purified by distillation or C-18 flash column chromatography prior to use.^{138,139} In addition, aryl stannanes are compatible with a wide variety of organic functional groups, making the use of tedious protecting group strategies unnecessary. Aryltributyl- and -trimethyltin reagents are typically synthesized from the corresponding aryl halide by the *in situ* conversion to a reactive organolithium or organomagnesium species followed by treatment with trialkyltin chloride (Scheme 27).^{19,138,140} The synthesis of organotin compounds *via* lithium and Grignard reagents has been recently reviewed.^{138,141-143}

Scheme 27

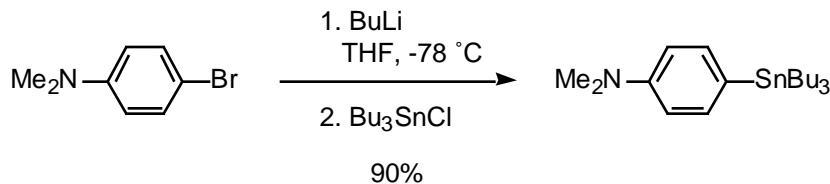

When electrophilic organic functional groups preclude the organometaloid method, the aryl halide substrate may be cross-coupled under Pd(0) catalysis with hexaalkyldistannanes (Scheme 28).^{19,138,144} The coupling approach is generally high-yielding, albeit limited to aryl iodides and bromides and intolerant of *p*-nitro and *p*-amino substituents on the aryl ring. The only detectable side reaction is homocoupling of the electrophile.¹⁹

Scheme 28

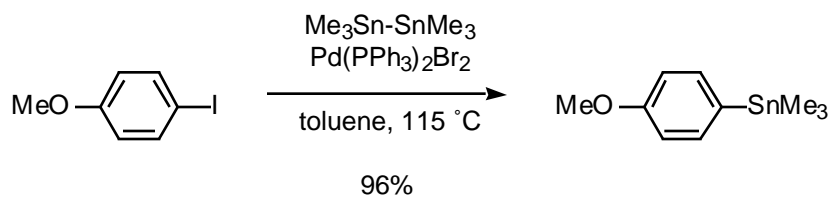

In place of a hexaalkyldistannane, tributyltin hydride was recently shown to couple with most aryl iodides under Pd(0) catalysis in the presence of a weak base (Scheme 29).¹⁴⁵ Two byproducts were observed: the homocoupled product (Ar–Ar), and the reduced (dehalogenated) arene (Ar–H). Aryl bromides were unreactive.

Scheme 29

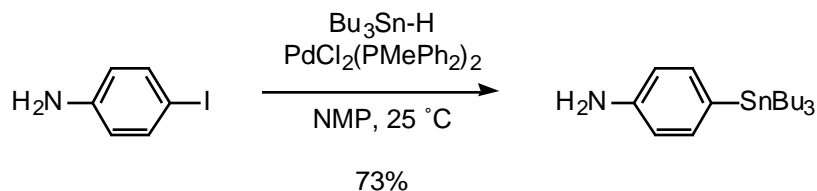

Less common methods for the synthesis of aryl tin derivatives include the photo-induced stannylation of mono and polychlorobenzenes using trimethylstannylsodium,¹⁴⁶⁻¹⁴⁹ and a Diels-Alder approach.^{143,150} A variety of *ortho*, *meta* and *para*-substituted aryl, pyridyl, and quinolinyl chlorides are substituted by Me_3Sn^- ions in liquid ammonia under irradiation to give the substitution product in high yields (Scheme 30).¹⁴⁶ The reaction is limited to aryl chlorides; aryl bromide and iodide derivatives undergo dehalogenation (reduction) under the reaction conditions.¹⁵¹ Despite its limited scope, the formation of the

tin reagent from the corresponding chloride is noteworthy in that aryl chlorides—which are more readily obtained than the corresponding bromide or iodide—cannot be readily converted to the stannane using either the metallation or the coupling approach.

Scheme 30

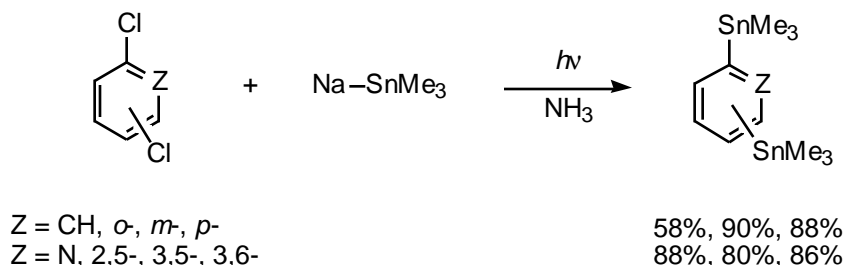

Lastly, the Diels-Alder reaction between methyl tributylstannylpropiolate (**64**) and alkyl substituted 1,3-butadienes (**63**) forms 1,4-cyclohexadienyl tin derivatives (**65**) in good yields; subsequent aromatization (elimination) gives the aryl tin reagent (**66**) (Scheme 31).^{143,150,152} The scope of this reaction is severely narrowed by a number of factors including (a) the often low regioselectivity of the cycloaddition reaction, and (b) only simple alkyl-substituted dienes and electron-deficient dienophiles undergo cyclization.

Scheme 31

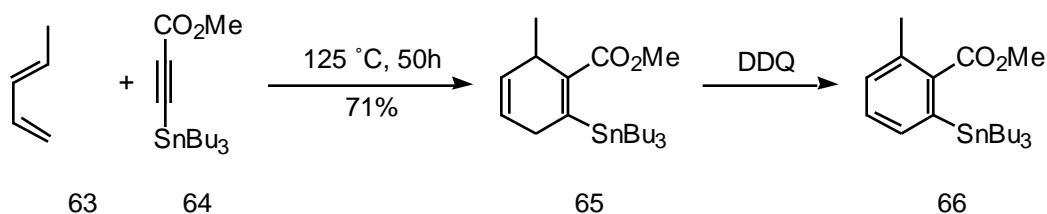

Preparation of Aryl Suzuki (Boron) Reagents

Organoboron reagents are a non-toxic alternative to organotin reagents, and have essentially superseded the use of tin compounds in the Pd-mediated cross-coupling reaction for the formation of biaryls.¹⁵³ As with tin reagents, Suzuki reagents are valued for their ease of handling and storage, due to their stability to moisture and oxygen.¹³⁹ Unlike

tin reagents, organoboranes are more difficult to synthesize and purify (they are often used as the crude isolate), however much work has been dedicated toward the development of efficient routes to the formation of these highly useful synthetic intermediates.^{10,20,153-155}

Methods for the synthesis of arylboronic acids and esters for use in Suzuki couplings are fundamentally the same as for Stille reagents. Aryl boron derivatives are classically synthesized from Grignard or lithium reagents and trialkyl borates; acid hydrolysis then gives the arylboronic acid (Scheme 32), or where feasible the ester may be coupled directly.¹⁵⁶ The organometalloid approach to the synthesis of organoboron compounds has been thoroughly reviewed.^{20,153,155} Unlike the tin electrophile R_3Sn-Cl , which bears only one leaving group, the typical methyl, ethyl or butyl borate electrophile $B(OR)_3$ can undergo bis- or tris-alkylation leading to the formation of borinic acid (i.e., $Ar_2B(OMe)$) or trialkylborane (Ar_3B) derivatives, respectively. Triisopropyl borate has been shown to sterically temper multialkylation of the borate, and it has become the electrophile of choice with highly reactive organometalloids.¹⁵⁷

Scheme 32

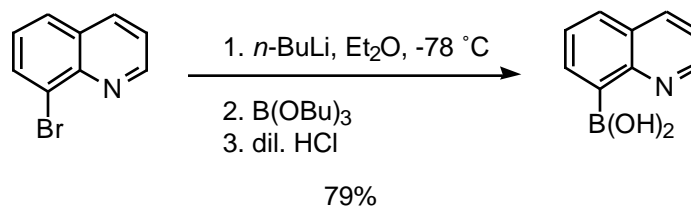

Unlike the traditional organometallic approach, Pd(0)-catalyzed borylation strategies enable access to boronic acid and ester derivatives in the presence of electrophilic functionalities such as nitro, ester, ketone and cyano groups. Aryl halides and pseudohalides undergo borylation under palladium catalysis using two different types of boron nucleophiles: alkyoxydiboron derivatives, $(RO)_2B-B(OR)_2$ or alkyoxy boranes, $H-B(OR)_2$ (Scheme 33). The Pd(0)-catalyzed cross-coupling approach to the synthesis of organoboron compounds has been reviewed.¹⁵⁸⁻¹⁶⁰

Scheme 33

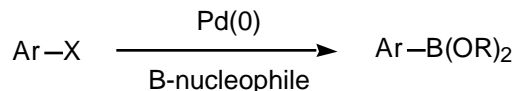

Miyaura has pioneered the use of bis(pinacolato)diborane for the borylation of aryl iodides,^{161,162} bromides,^{161,162} chlorides^{163,164} and triflates¹⁶⁵ (Scheme 34). The reaction tolerates various functional groups, however *ortho*-substituents or electron-donating substituents slow down the reaction significantly, necessitating the use of specialized catalysts and a higher catalyst loading to achieve reasonable reaction times.¹⁶³ The major reaction byproducts are the homocoupled starting material (believed to arise from the Suzuki reaction of the arylboronate product and unreacted aryl halide starting material), and reduced starting material (attributed to hydrolytic photodeboronation,¹⁶⁶ a particular problem with boronic acids and esters adjacent to a heteroatom).¹⁶³

Scheme 34

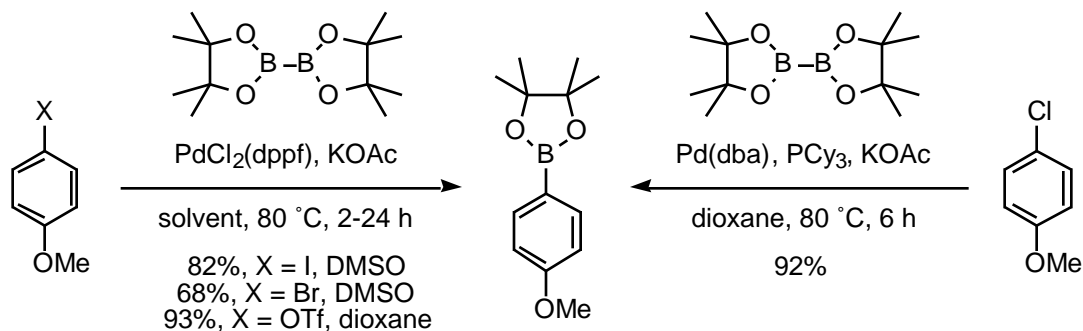

Strongin has extended the scope of the methodology to aryldiazonium salts: the Pd-catalyzed cross-coupling of bis(pinacolato)diborane and most *para*-substituted aryldiazonium salts proceeds efficiently in moderate to excellent yields (42–96%)(Scheme 35).¹⁶⁷ This reaction is notable in that the tetrafluoroborate salts are prepared from relatively inexpensive, readily available anilines. Also, this methodology features comparatively mild conditions, an environmentally-friendly alcohol solvent, and no added base; homocoupled contaminants were not observed (and no other byproducts were reported).¹⁶⁷

Scheme 35

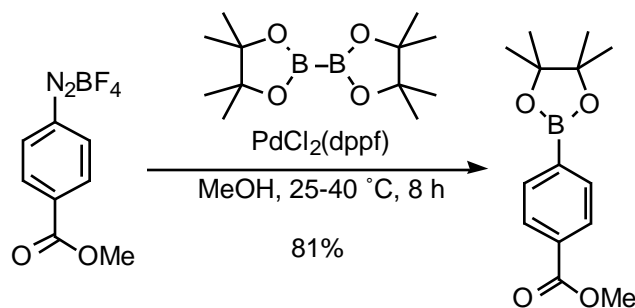

Masuda discovered that the coupling reaction of pinacolboron hydride with aryl iodides, bromides, or triflates in the presence of a catalytic amount of $\text{PdCl}_2(\text{dppf})$ or $\text{PdCl}_2(\text{PPh}_3)$, together with triethylamine afforded aryl boronates in good to excellent yields (Scheme 36).^{168,169} Since the initial report by Masuda, the reaction has not been greatly improved upon, although several variations of the reaction have appeared in the literature:¹⁷⁰⁻¹⁷³ Baudoin demonstrated that the reaction is catalyzed by $\text{Pd}(\text{OAc})_2$ and Buchwald's phosphine ($\text{PCy}_2(o\text{-biphenyl})$);¹⁷⁰ and LeFloch employed a novel phosphinine-Pd complex as an alternative catalyst.¹⁷¹

Scheme 36

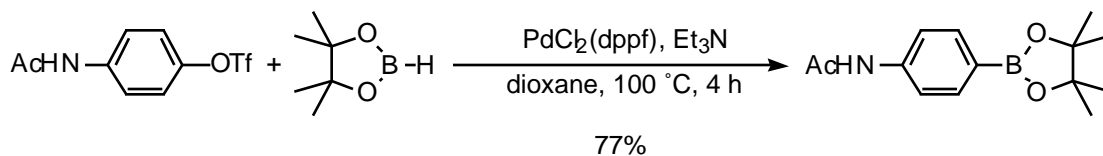

The cross-coupling reaction employing pinacolboron hydride tolerates a variety of electron-rich and -deficient functional groups and is relatively insensitive to solvent (dioxane, toluene, dichloroethane, and acetonitrile were all equally accommodated).¹⁶⁸⁻¹⁷¹ *Ortho*, *meta*, and *para* substituted substrates undergo equally efficient conversion to the boronate. As with the cross-coupling reactions using alkyl diboranes, aryl iodides are much more reactive than bromides or triflates, which require extended reaction times and elevated temperatures to reach completion. The major byproduct is the reduced substrate

Ar–H; when triethylamine is substituted by Hünig's base, pyridine, KOAc, or DBU, the reduced species predominates.

Less common methods for the synthesis of aryl boron derivatives include the rhodium or iridium-catalyzed borylation of arenes *via* C–H bond activation¹⁷⁴ and the regioselective Dötz annulation of Fischer carbene complexes with alkynyl boronates.¹⁷⁵ Both of these techniques are noteworthy in that each provides arylboronic acids without relying on the availability of the appropriate aryl halide. The former technique employs either pinacolboron hydride or bis(pinacolato)diborane, and was reviewed by Ishiyama in 2003.¹⁷⁴ An example of this method is shown in Scheme 37.¹⁷⁶ C–H bond activation suffers from the requirement for harsh reaction conditions, polyborylation, and often poor regioselectivity with mono or unsubstituted substrates; only disubstituted arenes and substituted heteroaromatics exhibit regiocontrol.

Scheme 37

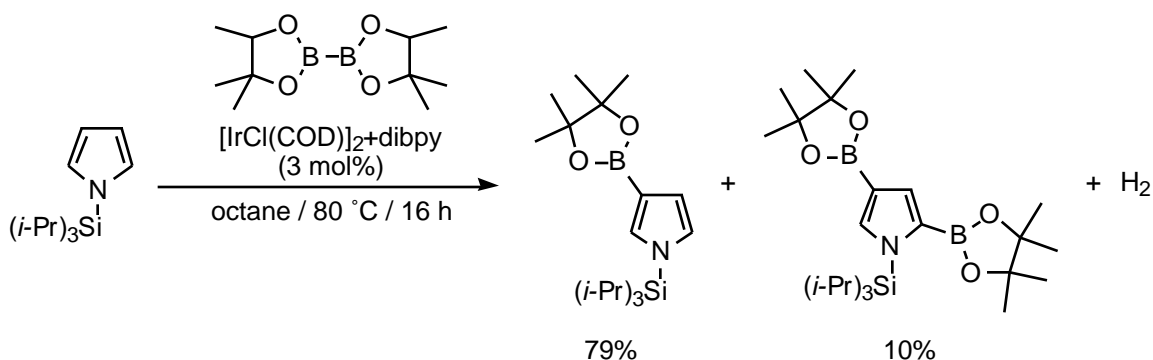

The benzannulation technique has some unexpected strengths: both the Fischer complexes and alkynyl boronates are readily accessible; and alkynyl boronates exhibit high regiospecificity in the Dötz annulation reaction, in stark contrast to the corresponding alkynylsilanes and -stannanes.¹⁷⁵ The reaction tolerates alkyl and phenyl substituents on the alkynyl boronate substrate; however the presence of bulky alkynyl substituents leads to the exclusive formation of cyclobutenone products. Harrity developed and applied this technique to the synthesis of a novel class of quinone and hydroquinone boronic acids (Scheme 38).¹⁷⁵ Aryl complex **67** and alkyne **68** underwent smooth

cycloaddition to provide arylboronate **69**; regioisomer **71** was not detected. The remaining yield was of quinone **70**, formed by the photodeborylation of the arylboronate product **69**.

Scheme 38

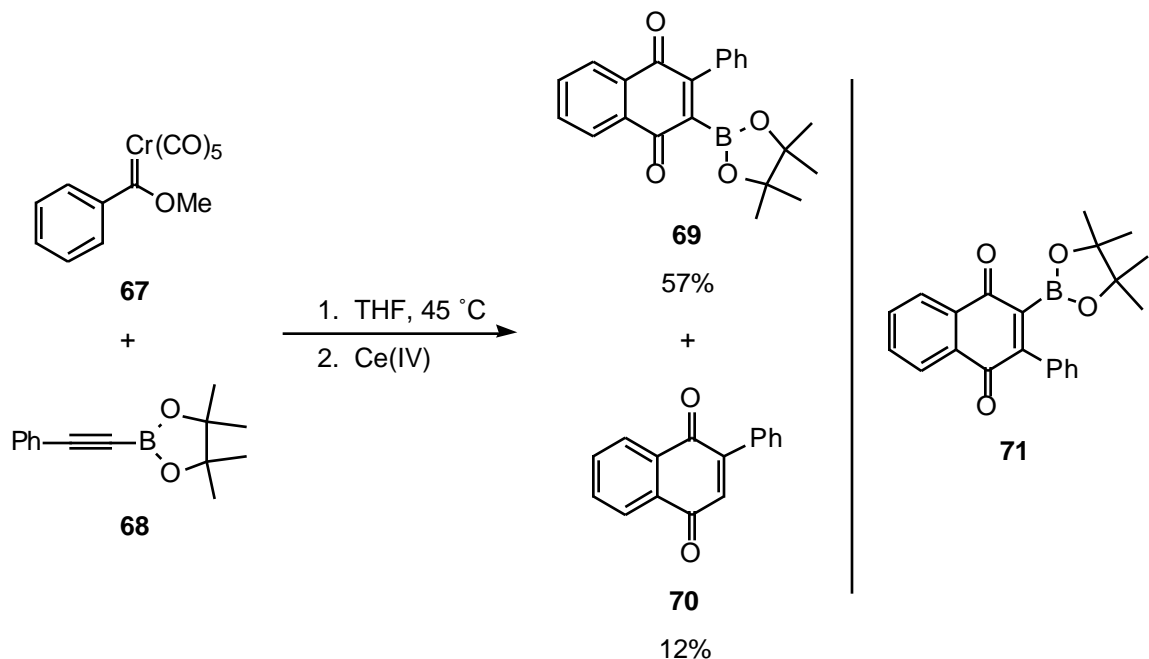

Preparation of Aryl Silicon Reagents

Previous studies from our group²¹⁻²⁵ as well as Hiyama,^{8,26-33} Ito,^{34,35} Denmark,³⁶⁻⁴⁴ and others⁴⁵⁻⁵⁶ have shown that a variety of silicon derivatives (i.e., compounds **72-78**, Figure 7) undergo fluoride-mediated, Pd(0)-catalyzed aryl group transfer reactions.⁵⁷⁻⁵⁹ The Pd-catalyzed cross-coupling reaction of organosilicon compounds has largely been studied by Hiyama and Hatanaka (aryl(alkyl)dihalosilanes **72-73**),^{8,26-33} and Shibata¹¹⁶ and DeShong²¹⁻²⁵ (aryl(trialkoxy)silanes **74**): all results to date indicate that these organosilicon derivatives participate in the cross-coupling reaction with similar efficiency and functional group tolerance as aryl stannanes and boranes.¹³⁹ While initial reports demonstrate that Denmark's³⁶⁻⁴⁴ arylsilacyclobutanes (**75**), and Mori's^{28,31,52,56} arylsilanols (**76-78**) will participate in the aryl-aryl cross-coupling process, the scope and utility of these reactions have yet to be demonstrated. In addition, the potential application of the silanol

methodology is limited by the need for stoichiometric amounts of silver(I) oxide as an activator.¹³⁹ Silacyclobutanes and silanols will not be discussed further.

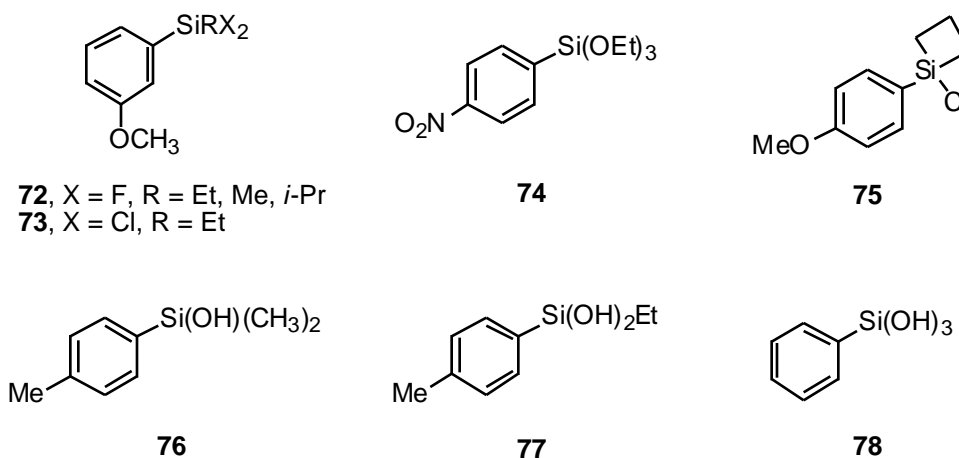

Figure 8. Silicon-Based Aryl Group Transfer Reagents.

Aryl(trialkoxy) and aryl(alkyl)dihalo silicon reagents (Ar-Si(OR)_3 and $\text{Ar-Si(R)}_2\text{X}_2$, respectively) possess many of the strengths, but few of the limitations associated with their tin and boron counterparts (*vide infra*).^{8,21-59} Cross-coupling prowess aside, it is the ease of working with these silicon reagents that has led to the flurry of interest in silicon-based aryl-group transfer reagents. Organosilicon derivatives—like boronic acids—are non-toxic relative to the tin compounds.²⁶ Organosilanes are readily available, stable to air and moisture, and—unlike many boronic acids and esters—can undergo purification by distillation or column chromatography, and are stable to most reaction conditions employed in synthetic chemistry.²⁶ Lastly, organosilicon compounds hold the promise of being more easily prepared than the notoriously problematic organoboron derivatives.

Hiyama and Hatanaka have pioneered the use of aryl(alkyl)dihalosilanes in the Pd-catalyzed cross-coupling reaction with aryl halides (Scheme 39).^{26,177,178} A range of silanes ($\text{Ar-SiR}_{3-n}\text{X}_n$) has been shown to participate in the cross-coupling, among which the optimal reagents are the aryl(alkyl)difluoro-^{1,8,177,179,180} and aryl(alkyl)dichlorosilanes.^{29,30} The non-transferable “dummy” alkyl ligand on silicon is typically methyl, ethyl or propyl,

although under certain conditions the methyl group is also capable of being transferred in the cross-coupling reaction, in competition with the aryl group.^{26,177,178}

Scheme 39

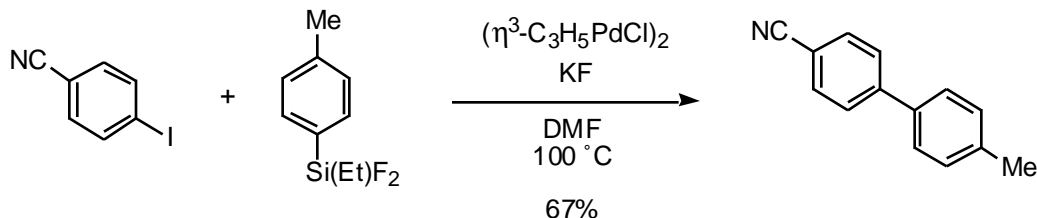

The organofluorosilane derivatives are synthesized from the corresponding organochlorosilanes in moderate yield (50-60%), using antimony trifluoride (SbF_3) (Swarts reaction)^{1,181-185} or CuF_2 (Scheme 40).^{1,9} This conversion has also been reported to occur in moderate yield with HF, although few applications of this technique to the synthesis of aryl(alkyl)difluorosilanes have appeared in the literature.^{181,186-188} Miscellaneous other methods for the formation of organofluorosilane derivatives *via* the cleavage of Si–X bonds other than chloride have been reported (i.e., X = OH, OR, H), but are of limited scope.^{119,185,188-190} Hiyama and Hatanaka have since developed a cross-coupling protocol employing aryl(alkyl)dichlorosilanes directly, thus avoiding an additional synthetic step, and the handling of the toxic and moisture-sensitive SbF_3 and CuF_2 .^{29,30}

Scheme 40

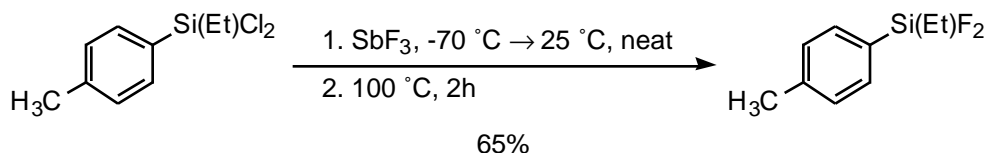

In parallel to the preparation of aryl tin and boron reagents, aryl(alkyl)dichlorosilane derivatives are traditionally synthesized from the corresponding aryl Grignard or lithium reagent and trichloro(alkyl)silane electrophiles (Scheme 41).^{1,29,33,181,183,187,190-195} No systematic study of the synthesis of aryl(alkyl)dichlorosilanes *via* the organometallic method has been reported, and little data exists in the literature: of the few reports stating

yields of purified product,^{33,193} a range of 33-88% (average yield of 50-60%) is given, and in no cases are the byproducts of the metallation reaction discussed or characterized. Hiyama and Hatanaka have demonstrated that crude aryl(alkyl)dichlorosilane derivatives prepared *via* metallation may be used without further purification for Pd-catalyzed cross-coupling, and report quantitative yields of crude silane *via* the metallation reaction.^{1,181}

Scheme 41

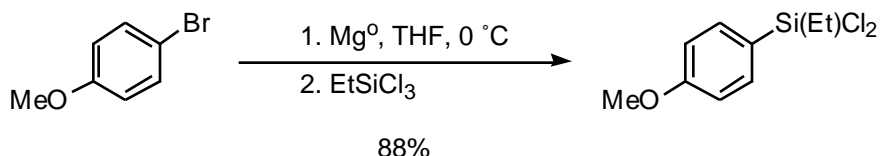

Ortho substitution of the aryl Grignard or lithium species strongly impacts the yield of the metallation reaction (Scheme 42).^{33,193} Hiyama demonstrated that silylation of *p*- and *m*-bromotoluene with Et-SiCl₃ occurred in good yield relative to *o*-bromotoluene.³³ The more sterically compact alkyltrifluorosilane electrophiles (R-SiF₃) have been shown to react with very hindered organometallic reagents where R-SiCl₃ failed to react,¹⁹¹ however this approach has never been applied to the systematic synthesis of *ortho*-substituted aryl(alkyl)difluorosilanes.

Scheme 42

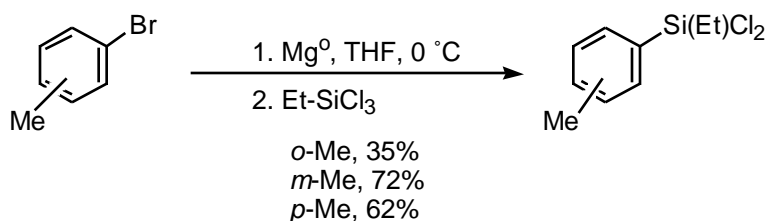

A second, less common method for the synthesis of aryl(alkyl)dichlorosilanes is silylative decarbonylation of aryl acid chlorides, as reported by Rich.¹⁹⁶ Again, this Pd-catalyzed cross-coupling technique is a good foil to the metallation reaction where electrophilic organic functional groups prohibit the organometaloid method. The palladium-catalyzed reaction of *sym*-tetrachlorodimethyldisilane(Cl₂(Me)Si-Si(Me)Cl₂) with benzoyl chloride derivatives was shown to form aromatic chlorosilanes in generally good yield (Scheme 43). The best yields were obtained with electron-deficient, *p*- and *m*-substituted

aromatic acid chlorides. The reaction failed for 2,6-pyridine dicarboxylic acid chloride (no reaction was observed), apparently due to complexation of the pyridine to the palladium catalyst. With few exceptions, the corresponding cross-coupling reaction of aryl halide substrates and $\text{Cl}_2(\text{Me})\text{Si}-\text{Si}(\text{Me})\text{Cl}_2$ fails.^{45,196-198}

Scheme 43

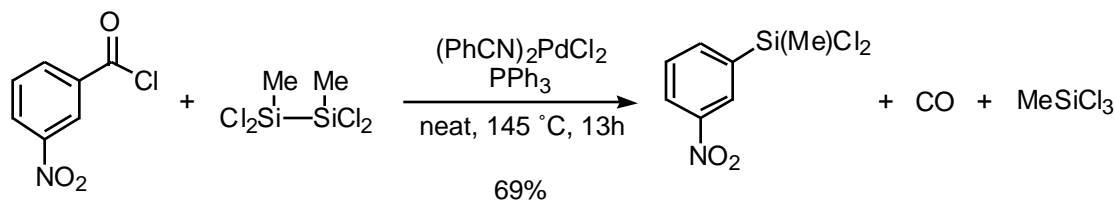

Miscellaneous other preparations of aryl(alkyl)dihalo silane derivatives have been reported, but are of limited scope or are only practical in the industrial laboratory.^{184,199-203} An efficient synthesis of *ortho*-substituted aryl(alkyl)dihalo silane derivatives has not been described.

In addition to functioning as aryl group transfer reagents, aryl(trialkoxy)silane derivatives ($\text{Ar}-\text{Si}(\text{OR})_3$) are important synthetic intermediates for the formation of hybrid organic-inorganic materials, such as synthetic glasses, ceramics, coatings or fibers prepared by sol-gel chemistry.^{118,204} These compounds are often called alkoxy silane “monomers,” in reference to the polymerization of organosilanes into water-soluble oligomers.²⁰⁴ Despite the multidisciplinary utility of arylsiloxanes, few practical methods for the preparation of trialkoxysilyl or trihalogenosilyl derivatives have been reported.

In analogy to the corresponding preparations of Stille and Suzuki reagents, the traditional method for the synthesis of aryl siloxanes is the treatment of an aryl Grignard or lithium reagent with a silicon electrophile (SiCl_4 , $\text{Cl}-\text{Si}(\text{OR})_3$, or $\text{Si}(\text{OR})_4$) (Scheme 44).

Scheme 44

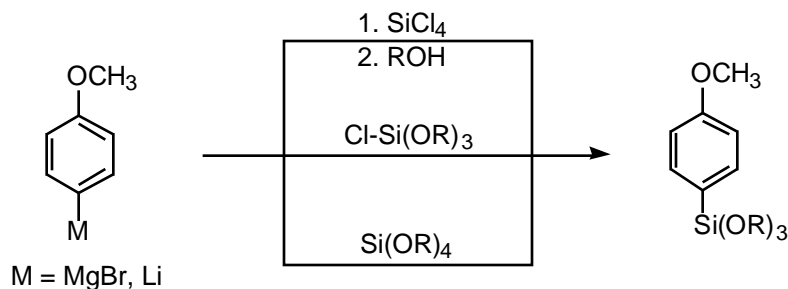

Aryl metals will react with silicon atoms bearing leaving groups other than chloride and alkoxy, including $-\text{CN}$, $-\text{H}$, $-\text{OSiR}_3$, $-\text{NR}_2$, and $-\text{OAc}$, however these reactions are of limited practicality: not only are the electrophiles tedious to prepare and purify, but in the case of $\text{H}-\text{Si}(\text{OR})_3$, the pyrophoric byproduct silane (SiH_4) is produced upon reaction with strong bases such as organometallic reagents.^{204,205} Other organometallic reagents generated by metal-halogen exchange have been employed in this transformation, as well, however they are of limited scope.^{121,204}

The first organometalloid method for the synthesis of arylsiloxane derivatives involves a two-step process: (1) the silylation of an arylmetaloid with commercially-available, inexpensive silicon tetrachloride (SiCl_4) to form the aryl(trichloro)silane intermediate; and then (2) alcoholysis (Scheme 45).^{116,206-214} Shibata synthesized a series of aryl(triethoxy)silanes in “acceptable” yields using Grignard or lithium reagents (the choice of metal was dictated by the ease of forming the carbanion).¹¹⁶

Scheme 45

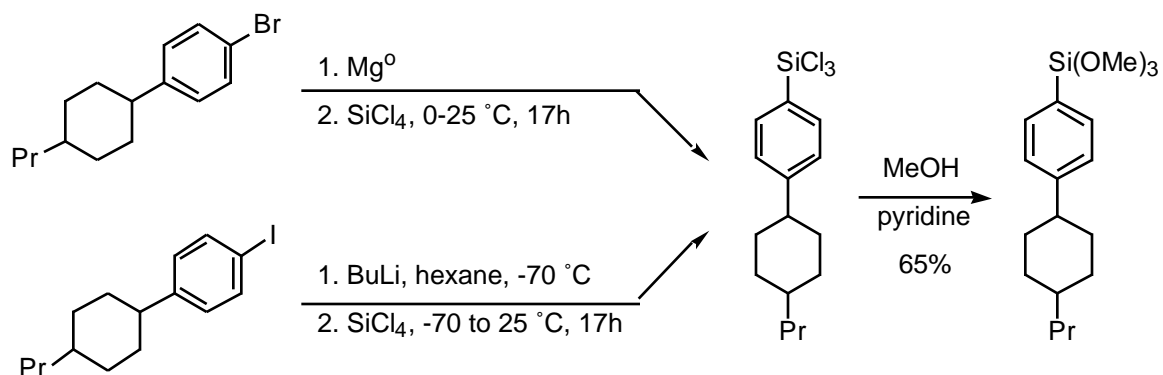

The use of SiCl_4 as the silicon electrophile is of limited practicality for a number of reasons which include (a) moderate to poor product yield for the overall, two step conversion, (b) the difficult transfer and handling of moisture-sensitive reagents and intermediates, and (c) multiple substitution results in the formation of difficult to separate byproducts (Scheme 46).^{206,210} Large quantities of electrophile (20+-fold excess) have been employed to mitigate polyarylation, however this leads to difficulties in product isolation and HCl contamination.²¹⁰

Scheme 46

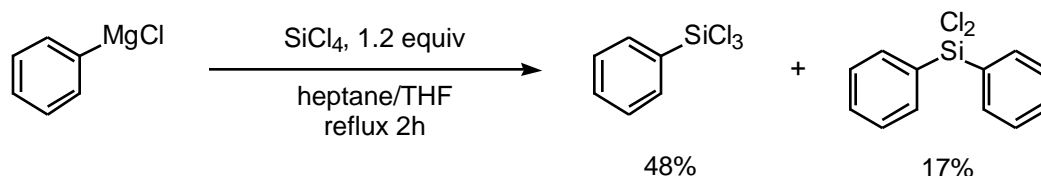

Treatment of the arylmetaloid with Cl-Si(OR)_3 should favor the formation of monoaryl siloxanes by preferential displacement of chloride from silicon.^{118,210,215,216} Not only are the yields somewhat better than the SiCl_4 /alcoholysis technique, but the reaction involves a single step from the formation of the organometaloid (i.e., Scheme 47).²¹⁶ However, use of Cl-Si(OR)_3 as the silicon electrophile still has several significant drawbacks: (1) unlike SiCl_4 , Cl-Si(OR)_3 compounds are not commercially available, and are tedious to prepare;^{121,217,218} (2) while less reactive than the tetrachloride, chloro(trialkyl)silane reagents still require careful handling to avoid hydrolysis of the reactive Si-Cl bond; and (3) surprisingly, even when excess electrophile is used, or low temperatures are employed, over-arylation of silicon occurs, resulting in inseparable di- and tri-arylated byproducts.^{204,210}

Scheme 47

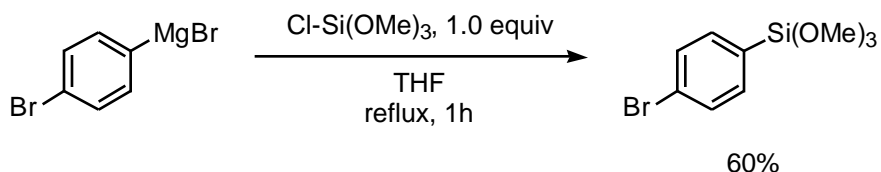

Treatment of the arylmetaloid with the less reactive electrophile Si(OEt)_4 should favor the formation of monoaryl siloxanes because alkoxide is more difficult to displace from silicon than chloride; typically, the reaction of organometallic reagents with alkoxy silanes is more selective than the reaction with chlorosilanes.²⁰⁴ As with the arylation of Cl-Si(OR)_3 , the typical yields of the silylation of organometallic reagents with Si(OEt)_4 are superior than the SiCl_4 /alcoholysis method, and this technique is more efficient because it involves only a single step from the formation of the organometaloid.^{116-120,209,214,219,220}

For example in Scheme 48, conversion of the series of bromotoluene regioisomers to the Grignard reagent, followed by treatment with 2 equiv of tetraethoxysilane afforded acceptable yields of the corresponding *ortho*- and *para*-(triethoxysilyl)toluene isomers; the low yield of *m*-(triethoxysilyl)toluene was attributed to the lowered nucleophilicity of the carbanion (electronic effect).¹²⁰

Scheme 48

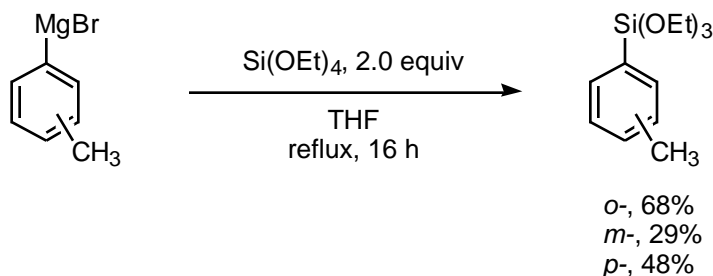

The use of Si(OR)₄ for the one-step preparation of arylsiloxanes *via* the organometallic approach has several advantages including the commercial availability, low cost, and ease of handling and storage of tetraalkoxysilanes.²⁰⁴ Polyarylation still occurs, however, lowering the yield of monoarylated silane, and necessitating careful fractional distillation or chromatography to isolate the desired product. For example, Frohn was able to make perfluorinated siloxane **80** in 55% yield from the Grignard reagent and Si(OEt)₄, where the modest yield was due to the formation of di- and triarylated products **81** and **82**, respectively (Scheme 49).²²⁰

Scheme 49

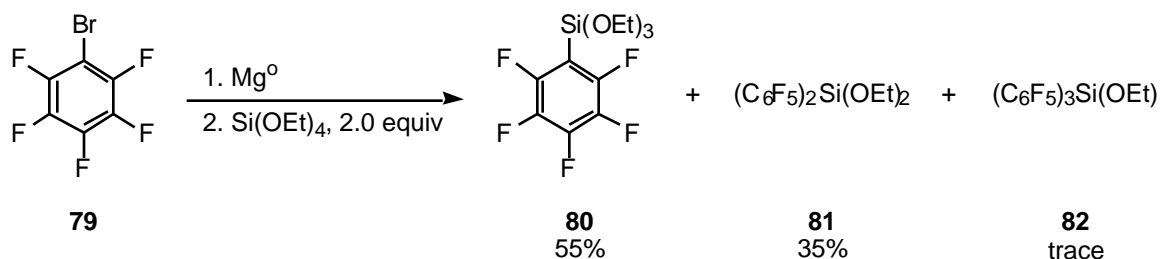

Masuda has reported the Pd(0)-catalyzed silylation of aryl iodides using triethoxysilane (H-Si(OEt)₃) (Scheme 50).^{58,221} The reaction was achieved with

triethoxysilane and $\text{Pd}_2(\text{dba})_3 \cdot \text{CHCl}_3$ with the addition of 2 equiv of tris(*o*-tolyl)phosphine and a base such as *i*-Pr₂NEt. Excellent yields of aryl siloxane were obtained with electron-rich, *para*-substituted aryl iodides. In contrast to aryl iodides, aryl bromides were reported to provide low yields of aryl siloxane under identical conditions. In addition, the silylation of *ortho*- or *meta*-substituted aryl iodides/bromides was not reported.

Scheme 50

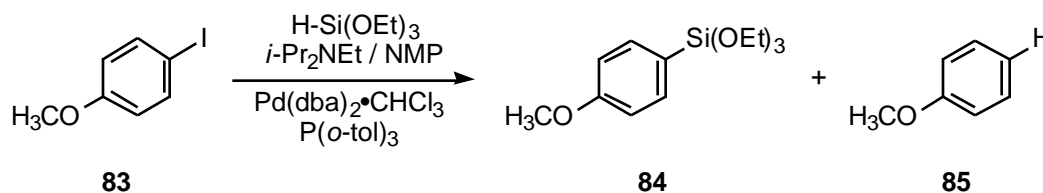

The major byproduct was the reduced substrate Ar-H (**85**); in contrast to the polyarylated silane byproducts formed using the organometallic technique, the reduced byproduct is readily separated by distillation or column chromatography. When Hünig's base was substituted by triethylamine, pyridine, KOAc, or left out of the reaction completely, the reduced species predominated.¹⁹ Electron-withdrawing groups not only slowed the reaction significantly, necessitating higher reaction temperatures and longer reaction times, but facilitated the transfer of hydride from the silane to give the reduced arene as the major product.^{19,159} With few exceptions, the corresponding cross-coupling reaction of aryl halide substrates and $\text{Cl}_3\text{Si-SiCl}_3$ fails,^{45,196,197} and silylation employing hexaalkoxydisilanes ((RO)₃Si-Si(OR)₃) has not been reported.¹⁹⁸

The Masuda method is an interesting alternative to the organometalloid approach in that the yields of the cross-coupling reaction are far superior than the metallation reaction with *para*-substituted electron-rich aryl halide substrates.²²¹ In addition, where the cross-coupling technique fails with *ortho*-substituted arenes, the metallation method works optimally. The Masuda technique is limited to aryl iodides, unlike the metallation method, which typically employs the more available aryl bromides (and sometimes chlorides). Unfortunately, neither the organometallic approach nor the silylation technique is effective for the silylation of arenes bearing electron-withdrawing, electrophilic moieties.

In conclusion, existing methods for the synthesis of aryl siloxanes fall into two categories (Scheme 51): (1) treatment of an aryl Grignard or lithium reagent with a silicon electrophile ; and (2) silylation of an aryl iodide by triethoxysilane (H-Si(OEt)_3) in the presence of a palladium catalyst as reported by Masuda.²²¹

Scheme 51

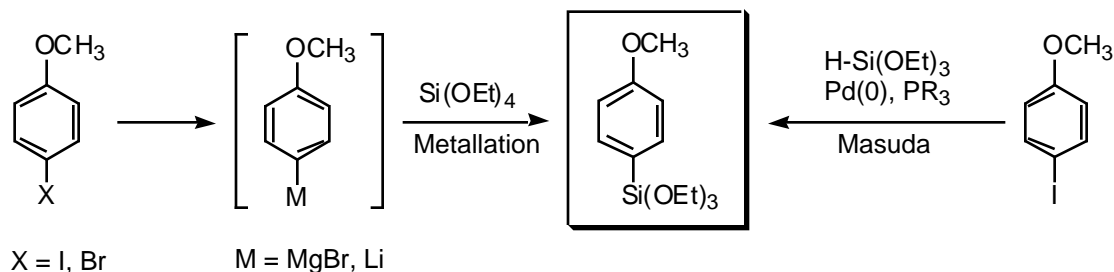

Both methods, as presently constituted, have their limitations. The metalloid reaction is limited by the generally inferior yields of monoarylsiloxane, as well as the problems associated with the synthesis of aryl metalloids having electrophilic functional groups (i.e. esters, ketones, etc.).¹¹⁶⁻¹²² A general method for the synthesis of arylsiloxanes from aryl lithium or magnesium reagents has not been reported, nor has a systematic study of this reaction been performed. Our first goal was to evaluate the metallation method, and to develop a practical, general synthetic technique utilizing standard organometallic reagents for the synthesis of aryl(trialkoxy)silanes. Ideally our method would employ the inexpensive, commercially available tetraethoxysilane, or its methoxy analog.

The Pd-mediated silylation protocol of Masuda is limited to electron-rich iodo arenes.²²¹ Masuda reported that electron-rich, *para*-substituted aryl iodides gave excellent yields of aryl siloxane. In contrast to aryl iodides, aryl bromides were reported to provide low yields of aryl siloxane under identical conditions. In addition, the silylation of *ortho*- or *meta*-substituted aryl iodides/bromides was not reported. Accordingly, the goals of this study were to extend the Masuda silylation reaction to aryl bromides and chlorides, and to evaluate the Masuda methodology for the synthesis of *ortho*- and *meta*-substituted aryl siloxanes.

Results and Discussion

Improved Synthesis of Aryl(trialkoxy)silanes via Treatment of Aryl Grignard or Lithium Reagents with Tetraalkoxysilane

Numerous methods for the formation of the aryl C–Si bond appear in the literature, the vast majority of which describe the trimethylsilylation of organic molecules.^{204,222,223} In contrast, few systematic studies of the synthesis of aryl(trialkoxy)silanes have been described, partly because the synthetic usefulness and interesting material properties of aryl(trialkoxy)silanes have only recently been discovered (*vide supra*).²⁰⁴ Our laboratory has focused specifically on aryl(trialkoxy)silanes as surrogates for Stille or Suzuki reagents (Scheme 52). Although initially described in a single paper by Shibata in 1997,¹¹⁶ the Pd-catalyzed fluoride-activated phenylation by phenyl(trialkoxy)silane derivatives has been independently cultivated into a practical synthetic technique by the DeShong group.^{21,23-25} The scope of the cross-coupling reaction now encompasses phenylation of a range of electron-rich and electron-deficient aryl halides and triflates, including sterically hindered arenes and heteroaromatic substrates.^{21,23-25} Having demonstrated the efficient phenylation, we wished to study the transfer of substituted aryl groups to ascertain the scope and limitations of the methodology. This study necessitated the synthesis of *ortho*-, *meta*-, and *para*-substituted, electron-rich and electron-deficient aryl siloxanes.

Scheme 52

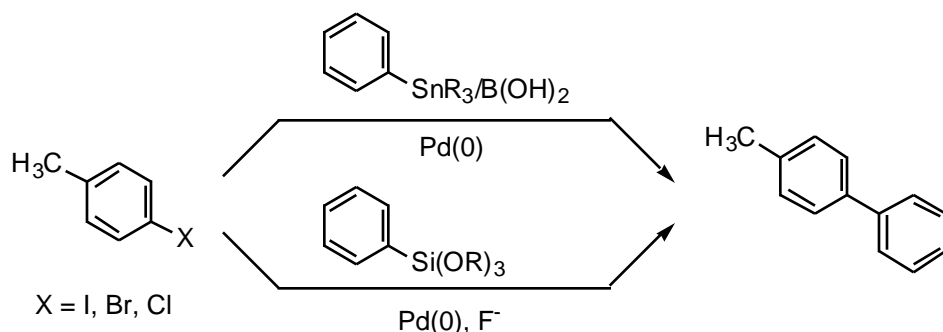

The most common approach to the formation of siloxanes is silylation of an aryl lithium or magnesium (Grignard) reagent (Scheme 53); Table 1 summarizes the literature to date. Although definitive conclusions cannot be drawn from this data, some generalizations can be made including (a) the yields are typically poor to modest, most likely due to competing formation of di- and tri- arylated products (over-arylation) (entries 1 and 26); (b) the choice of metal (Li or Mg) is dictated by the ease of forming the carbanion, although aryllithium reagents are much more reactive than the corresponding arylmagnesium reagents, requiring lower temperatures and shorter reaction times; (c) although SiCl_4 , Cl-Si(OR)_3 and Si(OR)_4 all perform similarly in the silylation reaction, the modest yield of the alcoholysis reaction of aryl(trichloro)silane derivatives limits the utility of SiCl_4 (entry 30); (d) heteroaromatic systems are particularly problematic (entries 10-12 and 31) and (e) the reaction tolerates a variety of aryl halides (*o*-, *m*-, and *p*-substituted, electron-rich as well as deficient arenes undergo silylation).

Scheme 53

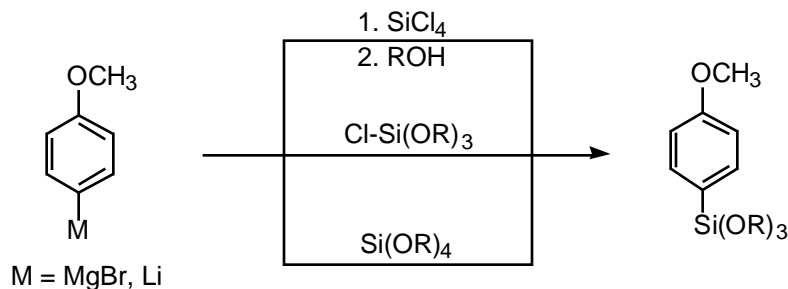

Toward our goal of synthesizing a variety of highly functionalized siloxane derivatives for use in aryl coupling reactions, it was necessary to determine the scope and limitations of the synthesis of aryl siloxanes from standard organometallic reagents. For our studies, 4-bromomagnesiumanisole **87**, Table 2) was selected as the initial nucleophile to be investigated in the metallation methodology. The inexpensive, commercially available electrophiles tetramethoxysilane (Si(OMe)_4), tetraethoxysilane (Si(OEt)_4) and tetrachlorosilane (SiCl_4) were each evaluated for their efficacy in the formation of the Si–Ar bond. The results are summarized in Table 2.

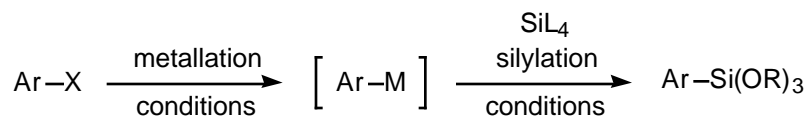

Entry	Conditions					
	Product Ar-Si(OR) ₃	Substrate Ar-X Ar-M		Metallation Ar-M	Silylation SiL ₄ (equiv)	Yield ^a %
1 ²²⁴		Br	Ar-MgBr ^b	Mg ⁰ /I ₂ Et ₂ O/THF reflux	Si(OMe) ₄ (1.5) Et ₂ O/THF 25 °C	35 ^c
2 ²²⁵		Br	Ar-MgBr ^b	Mg ⁰ /I ₂ THF 65 °C/2 h	Si(OEt) ₄ (4.0) THF 65 °C/12 h	74
3 ²²⁵		I	Ar-MgI ^b	Mg ⁰ /I ₂ THF 65 °C/2 h	Si(OEt) ₄ (4.0) THF 65 °C/12 h	68
4 ¹¹⁸		1-Br 4-Br	(1,4)-bis MgBr ^b	Mg ⁰ /I ₂ THF 65 °C/2 h	Si(OEt) ₄ (5.0) THF 65 °C/1 h	55
5 ¹¹⁸		1-Br 4-Br	(1,4)-bis Ar-Li	<i>t</i> -BuLi Et ₂ O -78 °C/4 h	Cl-Si(OEt) ₃ (2.5) Et ₂ O -78 to 25 °C	32
6 ¹¹⁸		4-Br 4'-Br	(4,4')-bis MgBr ^b	Mg ⁰ THF 65 °C/2 h	Si(OEt) ₄ (5.0) THF 65 °C/5 d	34
7 ¹¹⁸		4-Br 4''-Br	(4,4'')-bis Ar-Li	<i>t</i> -BuLi Et ₂ O -78 °C/4 h	Cl-Si(OEt) ₃ (2.5) Et ₂ O -78 to 25 °C	24
8 ¹¹⁸		4-Br 4''-Br	(4,4'')-bis Ar-Li	<i>t</i> -BuLi Et ₂ O -78 °C/4 h	Cl-Si(OEt) ₃ (2.5) Et ₂ O -78 to 25 °C	24
9 ²²⁶		I	Ar-Li	BuLi THF -105 °C	Cl-Si(OEt) ₃ (1.2) THF 0 °C/12 h	75
10 ²²⁷		Br	ArLi	BuLi Et ₂ O -78 °C/45min	Si(OEt) ₄ (2.0) Et ₂ O -78 to 0 °C	10

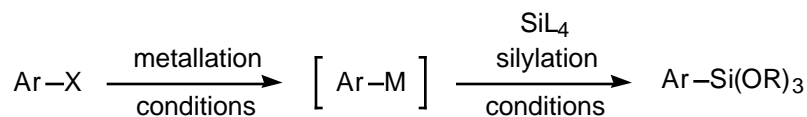

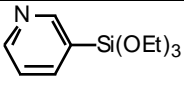
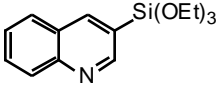
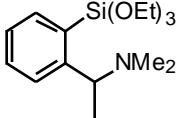
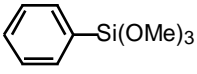
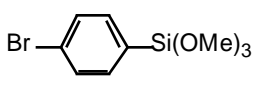
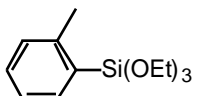
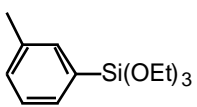
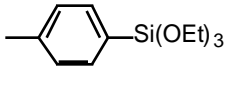
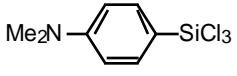
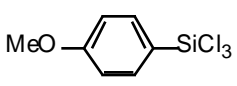

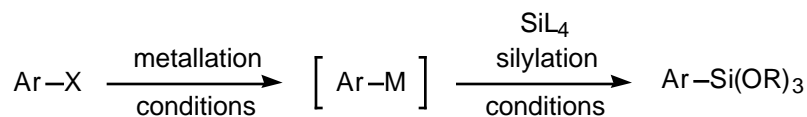
Entry	Conditions					
	Product Ar-Si(OR) ₃	Substrate Ar-X Ar-M		Metallation Ar-M	Silylation SiL ₄ (equiv)	Yield ^a %
11 ²²⁷		Br	ArLi	BuLi Et ₂ O -78°C/1h	Si(OEt) ₄ (2.0) Et ₂ O -78 to 0°C	16
12 ²²⁷		Br	ArLi	BuLi Et ₂ O -78°C/15min	Si(OEt) ₄ (2.0) Et ₂ O -78 to 0°C	21
13 ¹¹⁹		H ^d	ArLi	BuLi Et ₂ O 25°C/60 h	Si(OEt) ₄ (1.3) Et ₂ O 25°C/12h	56
14 ²¹⁹		Br	ArMgBr	Mg ^o Et ₂ O 25°C/4h	Si(OMe) ₄ (1.0) Et ₂ O 25°C/3 h	43
15 ²¹⁶		Br	ArMgBr	Mg ^o THF	Cl-Si(OMe) ₃ (1.0) THF 25°C/12h 65°C/1h	50
16 ¹²⁰		Br	ArMgBr	Mg ^o Et ₂ O/THF reflux	Si(OEt) ₄ (2.0) Et ₂ O/THF reflux/16 h	69
17 ¹²⁰		Br	ArMgBr	Mg ^o Et ₂ O/THF reflux	Si(OEt) ₄ (2.0) Et ₂ O/THF reflux/36 h	29
18 ¹²⁰		Br	ArMgBr	Mg ^o Et ₂ O/THF reflux	Si(OEt) ₄ (2.0) Et ₂ O/THF reflux/36 h	48
19 ²⁰⁸		Br	ArMgBr	Mg ^o THF 40°C	SiCl ₄ (2.0) THF/ heptane 40°C	40
20 ²⁰⁸		Br	ArMgBr	Mg ^o THF 40°C	SiCl ₄ (2.0) THF/ heptane 40°C	32

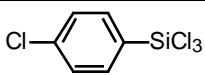
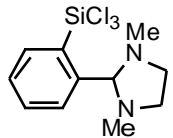
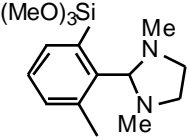
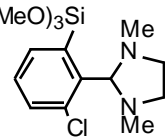
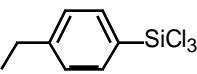
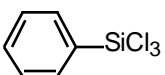
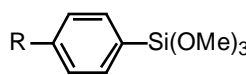
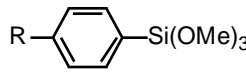

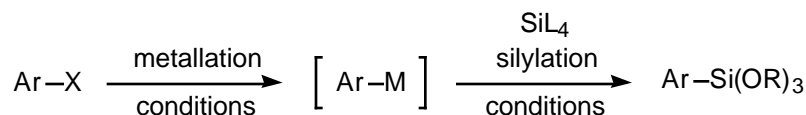
Entry	Conditions					Yield ^a
	Product	Substrate		Metallation	Silylation	
	Ar-Si(OR) ₃	Ar-X	Ar-M	Ar-M	SiL ₄ (equiv)	%
21 ²⁰⁸		Br	ArMgBr	Mg ^o THF 40°C	SiCl ₄ (2.0) THF/ heptane 40°C	39
22 ²¹⁴		H ^d	ArLi	BuLi Et ₂ O -30 to 0°C	SiCl ₄ (1.3) Et ₂ O 25°C/12h	91
23 ²¹⁴		H ^d	ArLi	BuLi Et ₂ O 25°C/60 h	Si(OMe) ₄ (1.3) Et ₂ O 25°C/12h	17
24 ²¹⁴		H ^d	ArLi	BuLi Et ₂ O 25°C/6 d	Si(OMe) ₄ (1.3) Et ₂ O 25°C/12h	17
25 ²⁰⁷		Br	MgBr	Mg ^o Et ₂ O	SiCl ₄ (1.5) Et ₂ O/ benzene 25°C/12h	59
26 ²⁰⁶		Cl	MgCl	Mg ^o THF	SiCl ₄ (1.1) THF/ heptane reflux/2h	47 ^e
27 ¹¹⁶	 R = 4-(Pr)-cyh-	Br	Ar-MgBr	Mg ^o THF 50°C/2h	1. SiCl ₄ (1.5) THF 25°C/17h 2. MeOH pyr/0°C	64 ^f
28 ¹¹⁶	 R = 4-(Pr)-cyh-	Br	Ar-MgBr	Mg ^o THF 50°C/2h	Si(OMe) ₄ (1.5) THF 25°C/17h	35

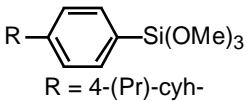

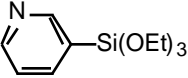
Entry	Conditions					
	Product Ar-Si(OR) ₃	Substrate		Metallation	Silylation	Yield ^a
	Ar-Si(OR) ₃	Ar-X	Ar-M	Ar-M	SiL ₄ (equiv)	%
29 ¹¹⁶		I	Ar-Li	BuLi THF -70°C/2h	1. SiCl ₄ (2.0) THF 25°C/17h 2. MeOH pyr/0°C	66 ^f
30 ²¹³		H ^d	Ar-Li	BuLi/TMEDA Hexane 25°C/2d	1. SiCl ₄ (1.1) hexane 25°C/12h 2. NaOEt THF/2d	6 ^f (22) ^h
31 ²¹⁰		Br	Ar-Li	BuLi Et ₂ O -78°C/30min	1. SiCl ₄ (2.0) Et ₂ O 25°C/3h 2. EtOH/TEA	15 ^f

^a Yields are after distillation. Byproducts were not reported. Unless otherwise indicated, the organometalloid (Ar-MgBr or Ar-Li) was first generated, and then combined with the indicated silicon electrophile SiL₄ (Si(OR)₄, Cl-Si(OEt)₃, or SiCl₄). ^b Grignard generated under Barbier conditions: Mg⁰, I₂ (if used), the silicon electrophile SiL₄ (Si(OR)₄, Cl-Si(OEt)₃, or SiCl₄) and solvent were combined and brought to the indicated temperature with stirring; the arylbromide was added at such a rate as to maintain reflux, and then the reaction was stirred at the given temperature until the reaction was complete. ^c A 41% yield of the diaryl(dialkoxy)silane and trace amounts of the triaryl(alkoxy) silane were isolated. ^d Aryl lithium generated by directed *ortho* metallation. ^e A 17% yield of the diaryl(dialkoxy)silane and a 10% yield of biphenyl were isolated. ^f The overall yield of Ar-Si(OR)₃ after alcoholysis of Ar-SiCl₃, based on the amount of substrate (Ar-X or Ar-H). ^g The major product was the diaryl(dialkoxy)silane. ^h The yield in parentheses indicates the yield of Ar-SiCl₃.

Table 1. Synthesis of Aryl(trialkoxy)silanes via Treatment of Aryl Grignard or Lithium Reagents with Silicon Electrophiles SiL₄: Review of the Literature to Date.

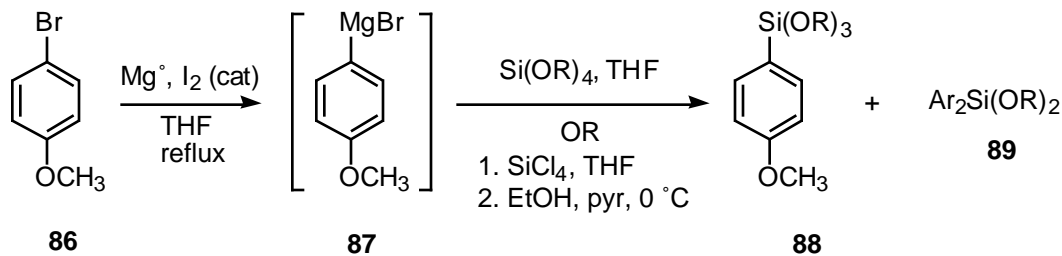

Entry	Conditions ^a		Yield (%) ^{b,c}	
	Silane / Equiv	T (°C)	88	89
1	Si(OMe) ₄ / 3.0	25	47	47
2	Si(OMe) ₄ / 3.0	-30	76	3
3	Si(OMe) ₄ / 1.5	-30	65	4
4	Si(OEt) ₄ / 3.0	0	72	23
5	Si(OEt) ₄ / 3.0	-10	70	23
6	Si(OEt) ₄ / 3.0	-30	83	3
7	Si(OEt) ₄ / 1.5	-30	76	2
8	Si(Cl) ₄ / 3.0 ^d	-30	70 ^d	3

^a Reactions of *p*-methoxy magnesium bromide **87** (1.0 equiv) with Si(OR)₄ or SiCl₄ (1.5 to 3.0 equiv) were allowed to stir at the given temperature in THF. The reaction mixture was stirred at the indicated temperature for 1 h, and then at room temperature for 12 h. ^b GC yields are based on amount of 4-bromoanisole (**86**). ^c The remainder of the product was of anisole. ^d Yield of 4-(triethoxysilyl)anisole (**88**). The crude, concentrated 4-(trichlorosilyl)anisole was converted to the siloxane **88** by dropwise addition of the chlorosilane to EtOH/pyridine at 0 °C.

Table 2. Optimization of the Synthesis of Arylsiloxanes Using 4-Bromomagnesium Anisole.

The temperature at which the Grignard reagent was added to the electrophile had a marked effect on the reaction. As seen in entries 1, 4 and 5, at temperatures above -30 °C a significant amount of the diaryl(dialkoxy)silane impurity **89** was formed, although no triaryl(alkoxy)silane was observed over the tested temperature range. The remainder of the reaction mixture was anisole, which can result from the aqueous quench of unreacted arylmagnesium bromide. However, longer reaction time or elevated temperature did not improve the yield. Also, the amount of anisole remained constant irrespective of the electrophile. It is likely that reduction occurs at least in part during the *in situ* formation

of the Grignard reagent, and is an inherent limitation of the metallation approach to the synthesis of siloxanes.

The best result was obtained when the Grignard reagent was treated at $-30\text{ }^{\circ}\text{C}$ with 3.0 equiv of the electrophile $\text{Si}(\text{OEt})_4$ (83% yield, entry 6); under identical reaction conditions, $\text{Si}(\text{OMe})_4$ (76% yield, entry 2) and SiCl_4 (followed by alcoholysis) (70%, entry 8) also performed well (the yields were determined by G.C. analysis). In contrast, Shibata observed a 60% yield of siloxane using the two-step SiCl_4 /alcoholysis method for the silylation of *p*-(4-propylcyclohexyl)phenylmagnesium bromide (Scheme 54, also above in Table 2, entries 27 and 28), but only a 35% yield of siloxane *via* direct silylation with $\text{Si}(\text{OMe})_4$. The reaction conditions employed by Shibata were addition of the Grignard reagent to 1.5 equiv of silane at $0\text{ }^{\circ}\text{C}$.¹¹⁶ In our study, a two-fold decrease in the concentration of the electrophile slightly decreased the yield of the desired monoarylated silane, but surprisingly did not stimulate the formation of diarylated byproduct (Table 3, entries 3 and 7).

Scheme 54

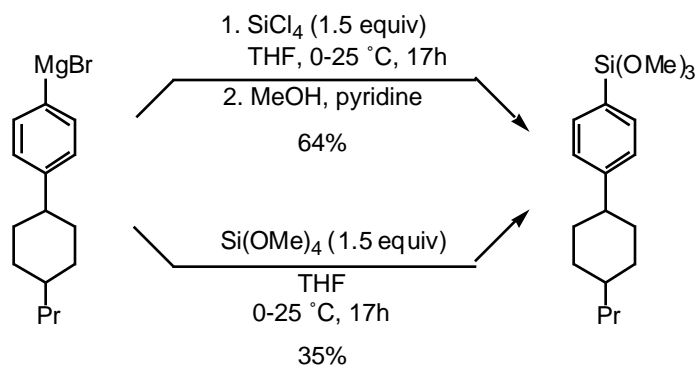

Preliminary studies performed by Arash Soheili (an undergraduate) using commercial phenylmagnesium bromide indicated that increasing the concentration of the electrophile from 3 to 5 to 30 equiv did not improve the reaction outcome, and only served to complicate product isolation. Soheili also observed little reaction improvement with alternative ether solvents, and poorer results with toluene or hexane. Ultimately, THF

Surprisingly, the results were comparable with *o*-, *m*-, and *p*-substituted anisyl and tolyl Grignard reagents (entries 2-4, and 7-9, respectively); all yields were approximately 80%. This result contradicts the findings of Selin and co-workers (Scheme 55, also above in Table 2, entries 15-17), who observed acceptable yields of *o*- and *p*-, but not *m*-(triethoxysilyl)toluene; the reaction conditions employed by Selin entailed addition of the Grignard reagent to 2.0 equiv of tetraethoxysilane at reflux.¹²⁰

Scheme 55

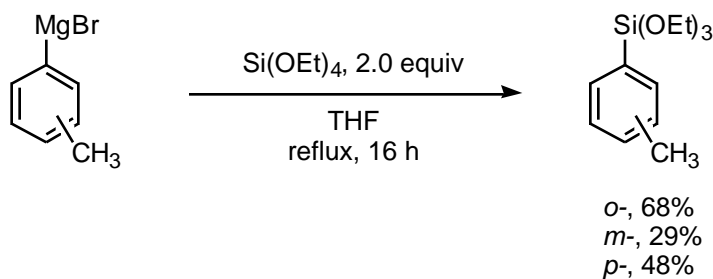

Several researchers have reported acceptable yields of arylsiloxane using Barbier reaction conditions—the *in situ* formation of the reactive Grignard intermediate in the presence of the silicon electrophile (Scheme 56, and Table 2, entries 1-4, and 6).^{118,130,224,225} Ideally, Barbier conditions are a method of controlling multiple substitution at silicon, because the Grignard reagent is immediately consumed, and never present in excess. For example, Shea and co-workers combined magnesium metal, a crystal of iodine, 4 equiv of tetraethoxysilane and THF, and brought the mixture to reflux (Scheme 56). A solution of *p*-bromoanisole (**86**) in THF was then added slowly, and the mixture was allowed to reflux for 12 h; a 74% isolated yield of 4-(triethoxysilyl)anisole (**88**) was obtained without mention of byproducts.²²⁵ This result was not reproducible in our laboratories: under identical Barbier reaction conditions, only 50% yield at 80% conversion was achieved; although no diarylated silane was observed, the remaining yield was of reduced arene.

Scheme 56

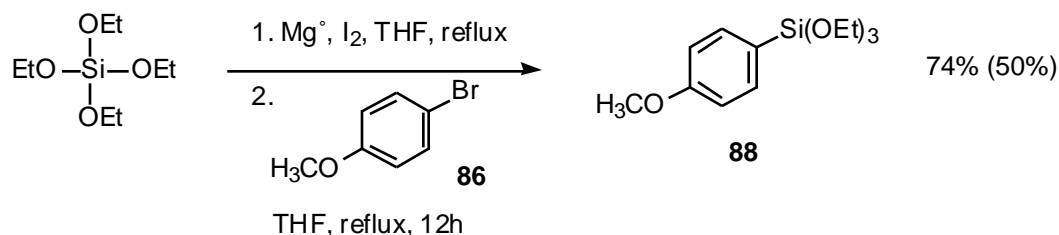

As shown in Table 3 (entry 5), 3,4-(methylenedioxy)bromobenzene underwent smooth conversion to the siloxane (**93**, 74% yield). Siloxane **93** was chosen as a model for siloxane **28**, which is a synthetic intermediate in the synthesis of Fitzgerald's compound **23** (Figure 4). Since the completion of this study, Correia in the DeShong laboratories has applied the Grignard methodology described herein toward the preparation of siloxane **94** in 50% yield from the corresponding bromide.²²⁹

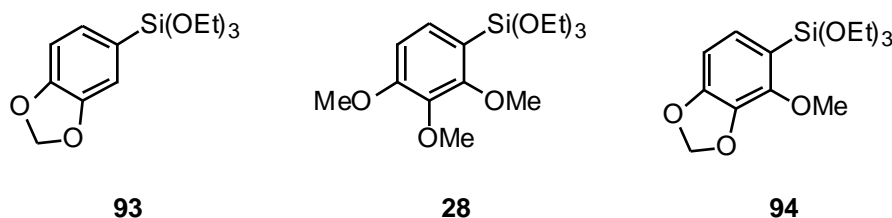
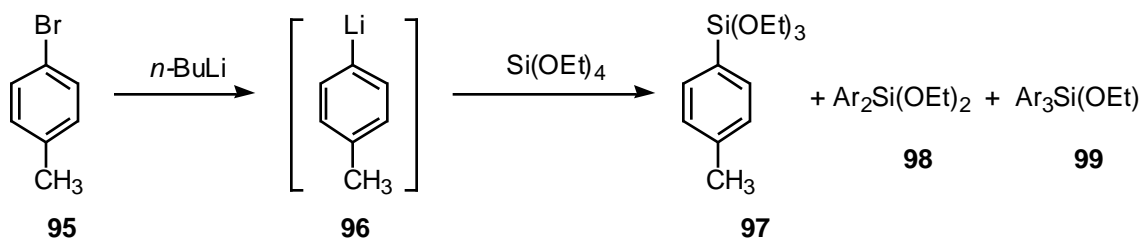

Figure 9. Siloxanes Prepared *via* the Grignard Reaction for Use in Natural Product Syntheses.

In continuing pursuit of our goal of synthesizing a variety of highly functionalized siloxane derivatives for use in aryl coupling reactions, we turned our efforts to determining the scope and limitations of the synthesis of aryl siloxanes from lithium reagents. For our studies, 4-lithiotoluene (**96**, Table 4) was selected as the initial nucleophile for investigation of the formation of the Si–Ar bond. The electrophile tetraethoxysilane (Si(OEt)₄) was chosen for initial study, in lieu of tetramethoxysilane (Si(OMe)₄), which freezes at the low temperatures required for the formation of aryllithium reagents, or tetrachlorosilane (SiCl₄), because the subsequent alcoholysis step had proven to be problematic (low yielding and complicated by polymerization). Both ether and THF were

evaluated for their suitability in the silylation of aryl lithium intermediates, although ether was the solvent of choice for practical reasons. The higher-boiling ethereal solvent was preferred for the Grignard protocol because it allowed for heating the reaction to initiate formation of the Grignard, or to drive silylation. The more reactive lithium reagents decompose above low temperatures and do not require higher-boiling solvents. The results of the silylation reactions are shown in Table 4.



Entry	Conditions ^a			Yield (%) ^{b,c}		
	Equiv Si(OEt) ₄	Solvent	T (°C)	97	98	99
1	1.5	THF	0	7	25	54
2	1.5	THF	-30	74	12	1
3	1.5	Et ₂ O	-30	77	6	0
4	1.5	THF	-78	81	9	0
5	1.5	Et ₂ O	-78	82	5	1
6	3.0	Et ₂ O	-78	86	3	1

^a Reactions of *p*-tolyl lithium **96** (1.0 equiv) with Si(OEt)₄ (1.5 to 3.0 equiv) were allowed to stir at the given temperature; the reaction was complete in 1 h. ^b GC yields are based on amount of 4-bromotoluene (**95**). ^c The remainder of the product was toluene.

Table 4. Optimization of the Synthesis of Arylsiloxanes Using 4-Lithiotoluene.

Like the Grignard approach, the temperature at which the lithium reagent was added to the electrophile dramatically effected the reaction outcome. As seen in entries 1-3, at temperatures above -78 °C a significant amount of the diaryl(dialkoxy)silane impurity **98** was formed. In addition, trialkylated product **99** was observed. Note that the analogous transformation employing Grignard reagents did not lead to the formation of

trialkylated products, because of the significantly lower reactivity of Grignard reagents. At 0 °C (entry 1), the major product was tris-*p*-tolyl(ethoxy)silane (**99**). In contrast, at –30 °C (entries 2 and 3) and –78 °C (entries 4-6) formation of the trialkylated silane **99** was effectively suppressed, although diarylated silane **98** was formed. As in the Grignard reaction, reduction (dehalogenation) of the starting material also was observed. At low temperature, the reaction was essentially insensitive to the solvent (Et₂O and THF were tolerated, entries 4 and 5) and only a small excess of the electrophile was needed (1.5-3.0 equiv were equally effective, entries 5 and 6).

The best result was obtained when the lithium reagent in ether was treated at –78 °C with 3.0 equiv of the electrophile Si(OEt)₄ (86% yield, entry 6). Experience garnered applying these reaction conditions to other substrates would show that more than 1.5 equiv were unnecessary to achieve the optimum yield of siloxane. The electrophile and the lithium reagent were allowed to stir at –78 °C until the reaction ceased to progress. Visiting Scientist Dr. Chuljin Ahn made the discovery that quenching the reaction at –78 °C before allowing the mixture to slowly warm to room temperature mitigated formation of di- and tri- arylated byproducts.

In order to demonstrate the scope of the optimized silylation reaction, a variety of substituted aryl bromides was examined (Table 5). The isolated yields obtained were generally better than those reported in the literature. Only trace amounts of diaryl(dialkoxy)silane contaminants were observed for most entries; again, the remaining yield was of reduced (dehalogenated) aryl halide. The best results were obtained with less reactive (less electron-rich) aryl lithium derivatives: the less electron-rich tolyl series (entries 1-3) and electron-neutral phenyl (entry 4) outperformed the more electron-rich anisyl/thioanisyl series (entries 5-8). Bearing two electron-donating substituents, the 3,4-(methylenedioxy)phenyllithium intermediate (entry 9) proved to be highly reactive: the major product was the diarylated silane. Reducing the temperature to –110 °C, or increasing the concentration of Si(OEt)₄ failed to improve the yield. Note that the analogous Grignard reagent underwent clean silylation (Table 3, entry 5), forming 74% of

triethoxy(3,4-methylenedioxyphenyl)silane. Again as with magnesium reagents, the reaction using aryllithium intermediates was insensitive to the position of substituents: *o*-, *m*-, and *p*-substituted arenes underwent silylation with equal efficiency (Table 5, entries 1-3, and 5-8).

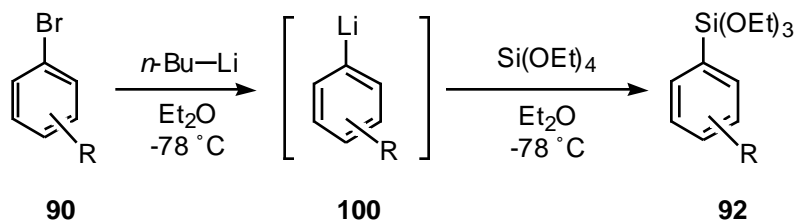

Entry	Aryl Siloxane (92)	% Yield ^{a,b}	Entry	Aryl Siloxane (92)	% Yield ^{a,b}
1		79	7		67
2		71	8		50
3		85	9		30 ^c
4		74	10		50
5		60	11		22 ^d
6		66	12		0

^a Reactions of aryl lithium **100** (1.0 equiv) with Si(OEt)₄ (1.5 equiv) were allowed to stir at -78 °C for 1 h in Et₂O. ^b Yields of **92** are after distillation or chromatography (purity >95%). ^c The major product was Ar₂Si(OEt)₂. ^d G.C. analysis indicated a 2:1:1 ratio of mono:di:tri arylalkoxysilanes.

Table 5. Synthesis of Aryl(trialkoxy)silanes Using Lithium Reagents.

Mixed results were obtained for silylation of heteroaromatic systems (entries 10-12). For example, an acceptable yield of 3-(triethoxysilyl)thiophene was obtained from the corresponding bromide (entry 10), whereas silylation of 2-bromofuran was inefficient and 2-bromopyridine failed to give any of the desired siloxane (entries 11 and 12). The yield of 2-(triethoxysilyl)furan was compromised by the formation of di- and triarylated products, indicating that 2-lithiofuran was successfully formed *in situ*, but was highly reactive. In contrast, attempted silylation of 2-bromopyridine led to exclusive formation of pyridine, indicating successful formation of the organolithium intermediate, but unsuccessful silylation. Dr. Chuljin Ahn confirmed the nearly quantitative formation of 2-lithiopyridine under our reaction conditions by capture with the more reactive electrophiles TMS-Cl and benzaldehyde.²²⁸ In an effort to increase the nucleophilicity of the pyridine metalloid, silylation of 3-bromo-4-methoxypyridine (**101**) was attempted with dramatic results. Handy isolated 25% of the desired monopyridinyl siloxane **102**, in addition to significant quantities of dipyridinyl- and tripyridinyl siloxanes **103** and **104**.¹¹¹

Scheme 57

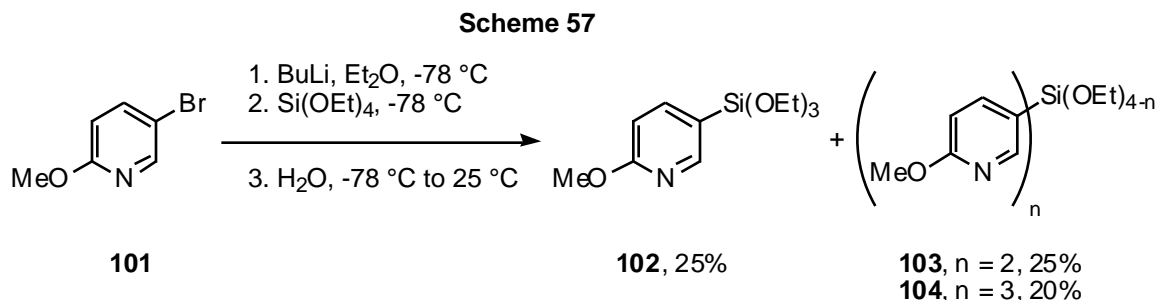

The results with pyridine derivatives were not surprising given the literature precedence. Using analogous reaction conditions, Schmidbaur and co-workers synthesized 2- and 3-(triethoxysilyl)pyridine in 10% and 16% yield, respectively (Table 2, entries 10 and 11).²²⁷ Zeldin carefully examined the synthesis of 3-pyridinyl substituted ethoxysilane monomers, focusing on the preparation of diethoxy(methyl)(3-pyridinyl)silane (PyrSiMe₂(OEt)).²¹⁰ A variety of silicon electrophiles were evaluated, most notably MeSiCl₃ (followed by alcoholysis), MeSi(OEt)₂Cl, and

MeSi(OEt)₃, under different metallation conditions. Three significant conclusions were drawn: (1) MeSi(OEt)₃ (3 equiv) was ideal for the methyl(diethoxy)silylation of 3-pyridinyl magnesium bromide, yielding 45% of the desired mono substitution product, and no diarylated adduct; (2) in contrast, a 20-fold excess of MeSiCl₃ was required to mitigate multiple substitution by 3-lithiopyridine, and as with MeSi(OEt)₂Cl, still yielded a significant amount of the diarylated silane and led to the formation of mixed silanes and silicates, for example **105** and **106** (Figure 10); and (3) the use of pyridinyl lithium reagents led to the formation of a pentacoordinate anionic species between the silane product and LiOEt formed in the displacement reaction (**107**). The decomposition of complexes **105-107** during distillation was blamed for the very low product yields.²¹⁰

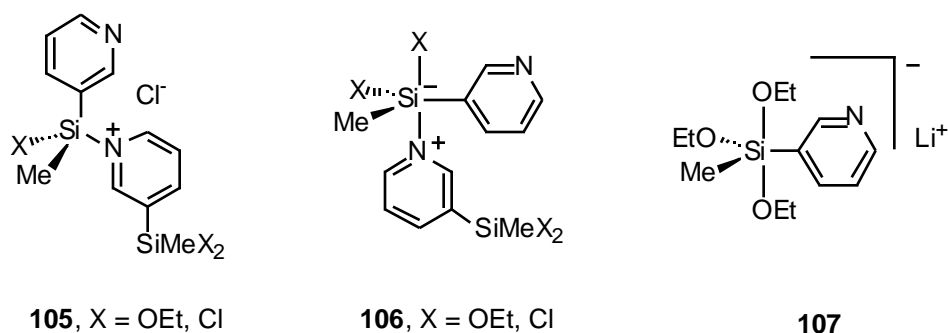
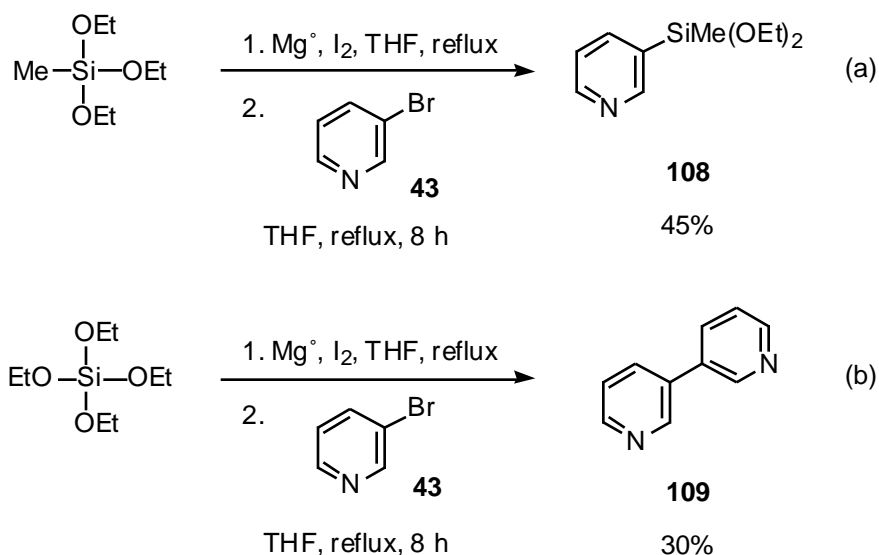

Figure 10. Complexes Formed in the Silylation of Pyridinyl Metal Reagents.

Zeldin obtained the best results when the pyridinyl Grignard reagent was generated under Barbier conditions (Scheme 58, eq. a); in fact, when the *performed* 3-pyridinyl magnesium bromide was treated with MeSi(OEt)₃, no reaction was observed.²¹⁰ Given that pyridinyl Grignard reagents are reputed to be unreactive toward most electrophiles,^{230,231} Zeldin's result is striking. Unfortunately in our laboratories, using the Barbier reaction conditions reported by Zeldin, but substituting Si(OEt)₄ as the electrophile, preparation of 3-(triethoxy)pyridine failed. The only products obtained were the homocoupled product 3,3'-dipyridyl (**109**) and pyridine (Scheme 58, eq. b). Homocoupling (Wurtz-type coupling) is a common side-reaction of organomagnesium reagents.¹¹⁵

Scheme 58



Since the completion of this study, Handy and Correia applied the general method for the synthesis of arylsiloxanes from aryllithium reagents outlined in Table 5 to prepare indole derivatives **110** and **111** in 70% and 60% yield, respectively.^{24,229} These 5-indole siloxanes are synthetic intermediates in the preparation of biologically-interesting tryptamines and tetrahydropyridylindoles.^{111,232} For the synthesis of siloxane **110**, Handy first converted 5-bromoindole to the potassium salt using KH; subsequent lithiation and treatment with Si(OEt)₄ afforded the siloxane.^{24,111}

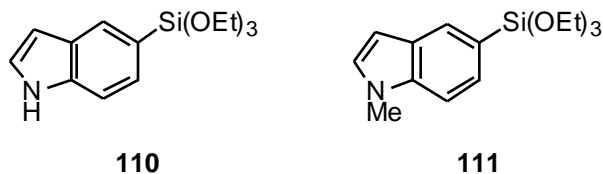

Figure 11. 5-Indole Siloxanes Prepared from Aryllithium Reagents for Use in Natural Product Syntheses.

With both Grignard and lithium reagents, the formation of di- and triarylated silanes was best controlled by employing reduced reaction temperatures. In contrast, change of solvent or the use of large excesses of the electrophile had relatively little impact on the reaction outcome. It is unlikely that the temperature effect observed in the arylation is due solely to the attenuation of organometalloid reactivity at reduced temperature. Contrary to

expectation, lower temperatures have been shown to increase the reactivity of the organometallic species toward electrophiles by causing deaggregation of the organometalloid.¹¹⁵ This phenomenon would clearly favor multiple arylation of the silane. Instead, a reduction in diarylation was observed when the temperature was reduced; therefore, the reactivity of the nucleophile must not be greatly altered within the temperature range studied. In fact, it has been observed that phenyllithium does not change its aggregation state until temperatures as low as $-100\text{ }^{\circ}\text{C}$ are reached.¹¹⁵

The relative rates of reaction of alkoxy silanes with organometallic reagents follows the order of silane electrophilicity: $\text{Si}(\text{OEt})_4 > \text{RSi}(\text{OEt})_3 > \text{R}_2\text{Si}(\text{OEt})_2 > \text{R}_3\text{Si}(\text{OEt})$; the same order is observed with chlorosilanes.²⁰⁴ Given the relative reactivities, polyarylation should be stoichiometrically controllable, or mitigated by slow addition of the organometallic reagent to the electrophile. On the contrary, even at low temperature, with less than 1 equiv of organometallic reagent, diarylated and even triarylated byproducts are observed, suggesting that other factors are at play than organometalloid reactivity or electrophile electronics.¹²²

The expected mechanism of alkylation comprises formation of pentacoordinate adduct **113** as shown in Scheme 59.^{122,204,233} Diarylation is the result of either direct attack of a second aryl nucleophile on the pentacoordinate silicate **113** to form hexacoordinate intermediate **115**, or attack on the tetracoordinate monoaryl silane **114**.

Scheme 59

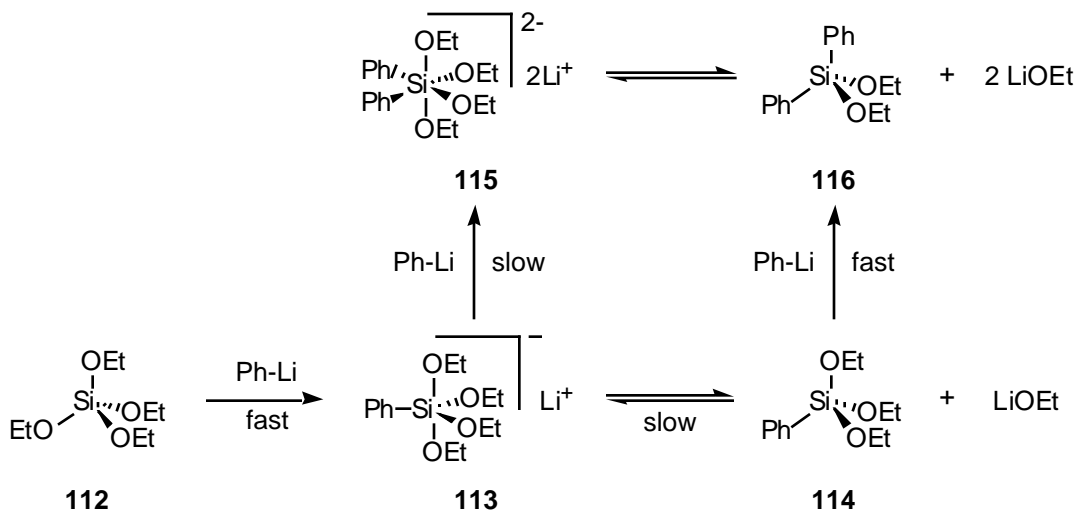

Again, it was observed that at lower temperatures the formation of diaryl products was minimal. We propose that at reduced temperature, the pentacoordinate silicate **113** formed by initial attack of the metalloid reagent does not decompose (with loss of alkoxide) to give the neutral monoaddition product **114**. The stable, anionic monoaryl silicate **113** is less reactive than its neutral monoaryl silane counterpart **114**; in effect, the monoaryl silane **114** is “protected” as the pentacoordinate silane against multiple arylation. This result is quite different than what has been observed for chlorosilanes, where the analogous pentacoordinate tetrachloroaryl silicate (Ar-SiCl_4) has been found to be more reactive than the neutral tetracoordinate monoaryl silane (Ar-SiCl_3).^{122,204,233}

In conclusion, general reaction conditions for the synthesis of aryl(trialkoxy)silanes from aryl Grignard and lithium reagents and functional silanes have been developed. Although examples in the literature have described the use of a range of silicon electrophiles (including SiCl_4 and Cl-Si(OR)_3), tetraalkyl orthosilicates (Si(OR)_4) allow for the most direct and convenient synthesis of arylsiloxanes, in that they are commercially available, inexpensive, and air and moisture stable. Using the reaction conditions developed herein, *o*-, *m*- and *p*-substituted bromoarenes underwent equally efficient metallation and silylation. Mixed results were obtained with heteroaromatic substrates: 3-bromothiophene, 3-bromo-4-methoxypyridine, 5-bromoindole, *N*-methyl-5-bromoindole all underwent silylation in good yield, whereas low yields of siloxanes were obtained from 2-bromofuran, and 2-bromopyridine failed to be silylated. Lower temperatures allowed for the formation of predominantly mono arylated siloxanes, without requiring more than 1.5-3.0 equiv of the electrophile.

Several important issues remain unresolved. Irrespective of the electrophile, the synthesis of aryl(trialkoxy)silane derivatives using Grignard or lithium reagents is plagued by modest yields caused by the formation of reduced (dehalogenated) substrate, and multiply arylated byproducts. These limitations are most likely inherent to the methodology: reduction of the organometalloid presumably occurs during the metallation step (and thus occurs in all reactions employing Grignard or lithium species); and multiple

alkylation stems from the high susceptibility toward nucleophilic attack of the hypercoordinate monoaryl(tetraethoxy)silicate intermediate.

Improved Methods for the Synthesis of Aryl(triethoxy)silanes via Palladium(0)-Catalyzed Silylation of Aryl Iodides and Bromides with Triethoxysilane

An alternative to the preparation of arylsilanes from organomagnesium or lithium intermediates was reported by Masuda and co-workers in 1997: the silylation of aryl iodide derivatives by triethoxysilane ($\text{H-Si}(\text{OEt})_3$) in the presence of a Pd catalyst (Scheme 60).²²¹ Masuda reported that electron-rich, *para*-substituted aryl iodides gave excellent yields of aryl siloxane. The major byproduct of the reaction was the reduced arene (**119**). In contrast to aryl iodides, aryl bromides were reported to provide low yields of aryl siloxane under identical conditions. In addition, the silylation of *ortho*- or *meta*-substituted aryl iodides/bromides was not reported. Accordingly, the goals of this study were to extend the Masuda silylation reaction to aryl bromides and chlorides, and to evaluate the Masuda methodology for the synthesis of *ortho*- and *meta*-substituted aryl siloxanes.

Scheme 60

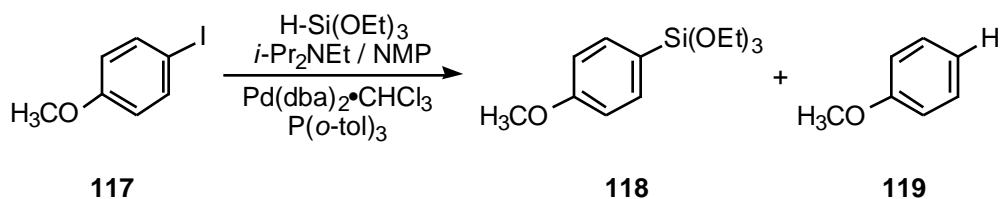

Toward our goal of synthesizing a variety of highly functionalized siloxane derivatives for use in aryl coupling reactions, it was necessary to determine whether Masuda conditions could be modified, and the scope extended to encompass silylation of aryl bromide derivatives. Standard optimization approaches involving change of solvent, reaction temperature, catalyst, base, and catalyst:ligand ratio failed to provide improved yields of siloxane. As reported by Masuda, the silylation reaction of phenyl bromide

under these conditions afforded the reduced arene rather than the desired siloxane derivative (see Scheme 60).²²¹

Previous studies in our laboratory²³ had shown that incorporation of Buchwald's phosphine **120** into Pd-catalyzed reactions resulted in dramatically improved yields of adducts.²³⁴⁻²³⁸ The use of Buchwald's and related phosphine derivatives in the silylation reaction was investigated and the results are summarized in Table 6. Entries 1 and 2 are the results obtained employing the standard conditions reported by Masuda and show that the silylation provided a low yield of the desired aryl siloxane.

The major product was the reduced arene. Substitution of Buchwald's ligand (**120**) as the phosphine resulted in a marked improvement in the yield of siloxane obtained (entry 10). Similarly, inclusion of

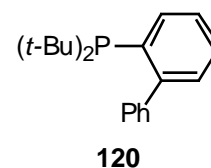

tributylphosphine (entries 6 and 7), as reported by Fu,²³⁹ had a less significant effect, and showed an appreciable difference in yield depending on the solvent. Subsequent studies were performed with the Buchwald ligand because of its inherent ease of handling, thus avoiding the air-sensitive nature of tributylphosphine. A variety of other ligands was investigated including mono- and bidentate phosphines (dppp, dppf, etc.), Buchwald's 2-(dicyclohexylphosphino)biphenyl, and triphenylarsine; however, these ligands failed to provide siloxane in acceptable yields. Similarly, additives such as tetraalkylammonium iodides, copper iodide, silver(I) salts, thallium acetate, or the inclusion of molecular sieves failed to improve the reaction outcome.

Solvents that are either less polar than NMP, or that can coordinate with the catalyst resulted in dramatically reduced yields of the siloxane (Table 6, entries 12-14). An amine base was required for silylation. In the absence of base, slow reduction of the starting material was observed (entry 15). Triethylamine (entry 16) gave more reduced material when compared to diisopropylethylamine, possibly due to its ability to coordinate as a ligand. Pyridine (entry 17) and 2,6-lutidine (entry 18) slowed the reaction dramatically and resulted in reduction preferentially. Replacement of the amine base by weak alkali bases such as KOAc (entry 20) and CsCO₃ (entry 21) was ineffective.

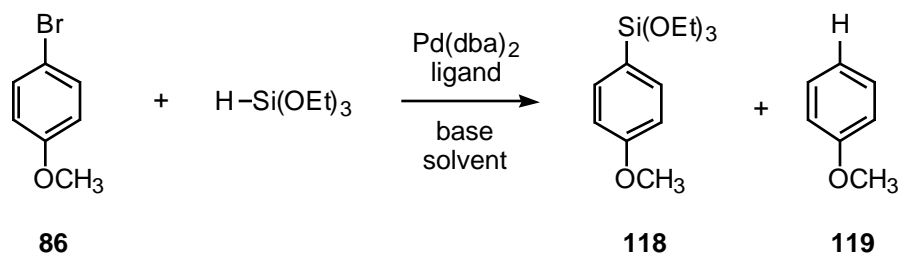

Entry	Conditions ^a			Yield (%) ^{b,c}	
	Ligand (10 mol %)	Base (3 mmol)	Solvent (4 mL)	118	119
1	P(<i>o</i> -tol) ₃	<i>i</i> -Pr ₂ NEt	NMP	21	79
2	P(<i>o</i> -tol) ₃	<i>i</i> -Pr ₂ NEt	DMF	15	70
3	none	<i>i</i> -Pr ₂ NEt	DMF	14	86
4	PPh ₃	<i>i</i> -Pr ₂ NEt	DMF	0	5
5	dppf	<i>i</i> -Pr ₂ NEt	NMP	0	8
6	P(<i>t</i> -Bu) ₃	<i>i</i> -Pr ₂ NEt	NMP	59	41
7	P(<i>t</i> -Bu) ₃	<i>i</i> -Pr ₂ NEt	DMF	45	55
8	P[(2,4,6-OMe)Ph] ₃	<i>i</i> -Pr ₂ NEt	NMP	8	92
9	P(cy) ₂ (<i>o</i> -biphenyl)	<i>i</i> -Pr ₂ NEt	NMP	17	83
10	P(<i>t</i> -Bu) ₂ (<i>o</i> -biphenyl)	<i>i</i> -Pr ₂ NEt	NMP	75	25
11	P(<i>t</i> -Bu) ₂ (<i>o</i> -biphenyl)	<i>i</i> -Pr ₂ NEt	DMF	36	64
12	P(<i>t</i> -Bu) ₂ (<i>o</i> -biphenyl)	<i>i</i> -Pr ₂ NEt	THF	6	54
13	P(<i>t</i> -Bu) ₂ (<i>o</i> -biphenyl)	<i>i</i> -Pr ₂ NEt	CH ₃ CN	6	93
14	P(<i>t</i> -Bu) ₂ (<i>o</i> -biphenyl)	<i>i</i> -Pr ₂ NEt	toluene	3	19
15	P(<i>t</i> -Bu) ₂ (<i>o</i> -biphenyl)	none	NMP	0	4
16	P(<i>t</i> -Bu) ₂ (<i>o</i> -biphenyl)	Et ₃ N	NMP	55	45
17	P(<i>t</i> -Bu) ₂ (<i>o</i> -biphenyl)	pyridine	NMP	0	5
18	P(<i>t</i> -Bu) ₂ (<i>o</i> -biphenyl)	2,6-lutidine	NMP	32	26
19	P(<i>t</i> -Bu) ₂ (<i>o</i> -biphenyl)	DBU	NMP	0	57
20	P(<i>t</i> -Bu) ₂ (<i>o</i> -biphenyl)	KOAc	NMP	22	78
21	P(<i>t</i> -Bu) ₂ (<i>o</i> -biphenyl)	Cs ₂ CO ₃	NMP	3	97

^a Reactions of 4-bromoanisole (**86**) (1.0 equiv) with H-Si(OEt)₃ (1.5 equiv) were allowed to stir at room temperature for 12 h in 4 mL of solvent by using Pd(dba)₂ (5 mol %), phosphine (10 mol %), and base (3.0 equiv). ^b GC yields are based on amount of 4-bromoanisole. ^c Remaining percentage was unreacted starting material.

Table 6. Optimization of the Silylation of 4-Bromoanisole.

In order to demonstrate the scope of the modified silylation reaction, a variety of substituted aryl bromides was examined (Table 7). The best yields of siloxane were obtained for electron-rich aryl bromides (entries 1-7) although the yields obtained are generally modest. This trend was not unexpected based on the report from Masuda with

iodides.²²¹ Silylation of bromobenzene or electron-poor aryl bromides was unsuccessful (entries 8-10), exclusively resulting in dehalogenation of the starting material.

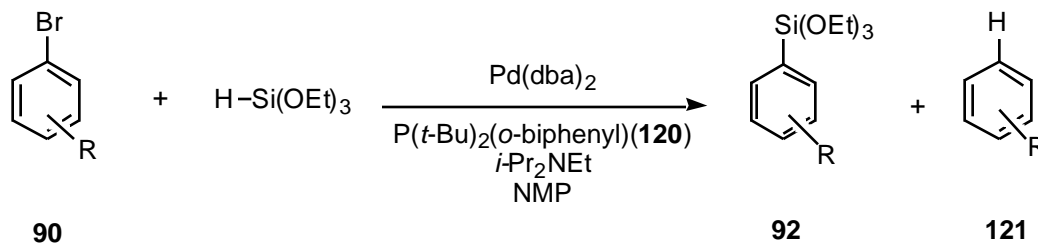

Entry	Aryl Bromide (90)	% Yield ^{a-c} (92)	Entry	Aryl Bromide (90)	% Yield ^{a-c} (92)
1		68	6		30
2		43	7		28 ^{d,e}
3		44	8		5
4		33	9		0
5		38 ^{d,e}	10		0

^a Reactions of arylbromide (**90**) (1.0 equiv) with H-Si(OEt)₃ (1.5 equiv) were allowed to stir at 60 °C for 12 h in NMP by using 3 mol % Pd(dba)₂, (t-Bu)₂P(o-biphenyl)(**120**) (6 mol %), and i-Pr₂NEt (3 equiv). ^b Isolated yield of purified (>95%) product. ^c Unless otherwise indicated, remaining percentage was reduced starting material (**121**). ^d Reaction allowed to stir at room temperature. ^e Reaction stopped at 2 h.

Table 7. Silylation of Aryl Bromides.

Mixed results were obtained for heteroaromatic systems (Table 8). For example, a satisfactory yield of 2-(triethoxysilyl)thiophene was obtained from the corresponding bromide (entry 1), whereas, silylation of 2- and 3-bromopyridine and 2- and 3-bromoquinoline failed (entries 2-5), probably due in part to nitrogen functioning as a ligand for the metal (*vide infra*). Support for this hypothesis is that use of Pd(0)/pyridine as a catalyst system for the silylation of 4-bromoanisole (Table 1, entry 17) resulted in a

dramatic reduction in the rate of silylation. Not surprisingly, the more electron-rich substituted pyridine derivative 3-bromo-4-methoxypyridine was converted to the siloxane in fair yield (Table 8, entry 6).

Ar-Br	+	H-Si(OEt) ₃	$\xrightarrow[\substack{\text{P}(t\text{-Bu})_2(\text{o-biphenyl})(\mathbf{120}) \\ i\text{-Pr}_2\text{NEt} \\ \text{NMP}}]{\text{Pd}(\text{dba})_2}$	Ar-Si(OEt) ₃	+	Ar-H
122				123		124

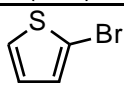
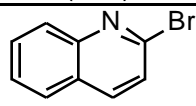
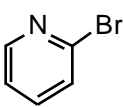
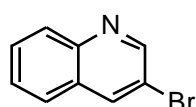
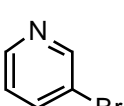
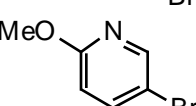
Entry	Heteroaryl Bromide (122)	% Yield ^{a-c} (123)	Entry	Heteroaryl Bromide (122)	% Yield ^{a-c} (123)
1		43	4		0
2		0 ^d	5		0
3		0	6		57

^a Reactions of heteroaryl bromide (**122**) (1.0 equiv) with H-Si(OEt)₃ (1.5 equiv) were allowed to stir at 60 °C for 12 h in NMP by using 3 mol % Pd(dba)₂, (t-Bu)₂P(o-biphenyl)(**120**) (6 mol %), and *i*-Pr₂NEt (3 equiv). ^b Isolated yield of purified (>95%) product. ^c Unless otherwise noted, the remaining percentage was reduced starting material (**124**). ^d Trace amounts of 2,2'-dipyridyl were observed by G.C. analysis.

Table 8. Silylation of Heteroaryl Bromides.

Given that the yield of silylated arene was dependent upon the electron-rich character of the arene system, it was expected that 4-bromo-1,2-(methylenedioxy) benzene (Table 7, entry 3) would give a comparable (or greater) yield of siloxane than 4-bromoanisole (entry 1). Surprisingly, the opposite was observed. It was proposed that the presence of a substituent at the *meta* position resulted in the lower yield. Further exploration of the effect of substituent placement on the silylation of bromoanisoles was undertaken and the results are summarized in Table 9. The yield of siloxane rapidly declined as the methoxy substituent shifted from the *para* (68%) to *meta* (25%) to *ortho*

(0%) position. Attempts to improve the yield of *meta*- or *ortho*-aryl siloxanes by altering the phosphine ligand were unsuccessful.

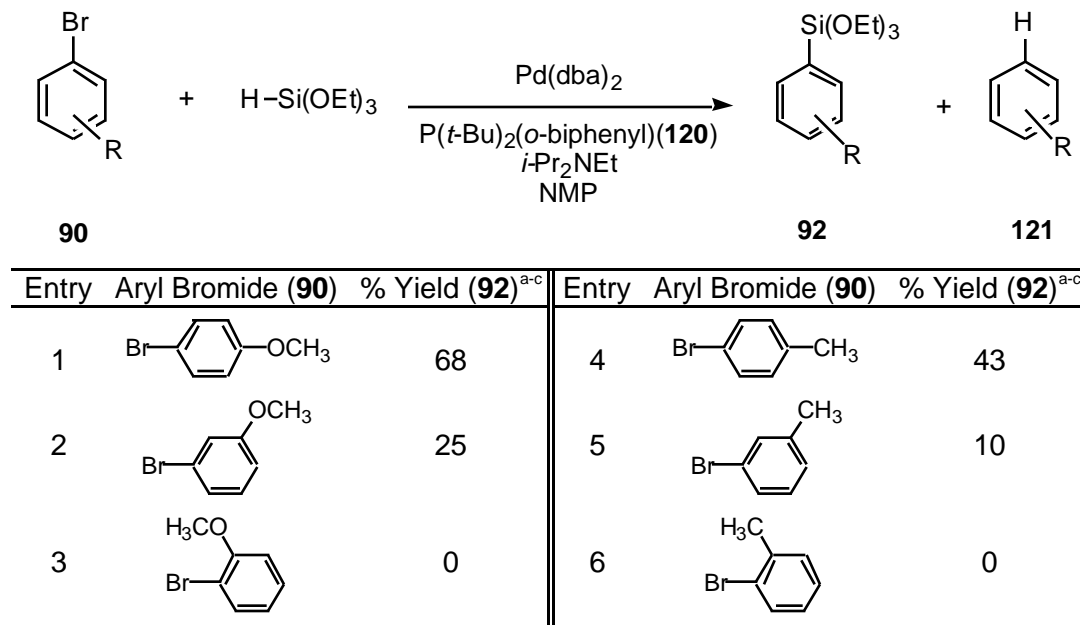

^a Reactions of arylbromide (**90**) (1.0 equiv) with H-Si(OEt)₃ (1.5 equiv) were allowed to stir at 60 °C for 12 h in NMP using 3 mol % Pd(dba)₂, (t-Bu)₂P(o-biphenyl) (**120**) (6 mol %), and *i*-Pr₂NEt (3 equiv). ^b Yields are isolated yields of purified (>95%) product. ^c Remaining yield was of reduced starting material (**121**).

Table 9. Silylation of Aryl Bromides: Effect of Substituent Position.

There are several possible explanations for the effect of *ortho* and *meta* substitution on the silylation reaction. It was initially thought that coordination of the Lewis basic oxygen lone pair of the methoxy substituent to palladium or silicon was responsible for this outcome (Figure 12). However, a non-coordinating *ortho*-methyl substituent also prevented silylation (Table 9, entry 6) indicating that steric interference also had a significant role. Additionally, coordination of the *ortho*-methoxy oxygen to silicon was not observed by either ²⁹Si or ¹⁹F-NMR,¹¹¹ although this result does not rule out the possibility that the dative bond in the hypercoordinate system **127** forms under the reaction conditions. Sterically hindered *ortho*- and *meta*-substituted aryl silanes have been shown to be more susceptible to acid²⁴⁰⁻²⁴⁴ and base^{229,245-248}-catalyzed protodesilylation than the

less hindered *para*-substituted analogs, regardless of the nature of the *ortho* substituent. Truthfully, it is proposed that both steric and electronic factors are responsible for the decreased yields in this reaction. The potential effects of substituent position on the mechanism of the silylation reaction are discussed in detail below.

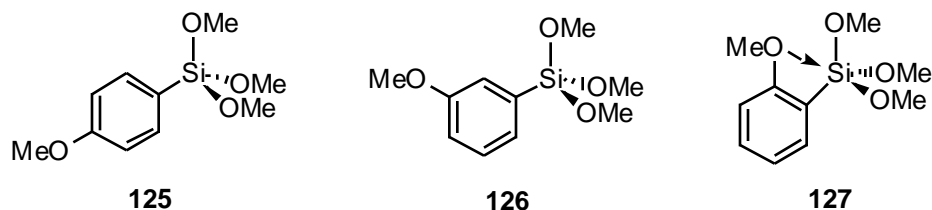
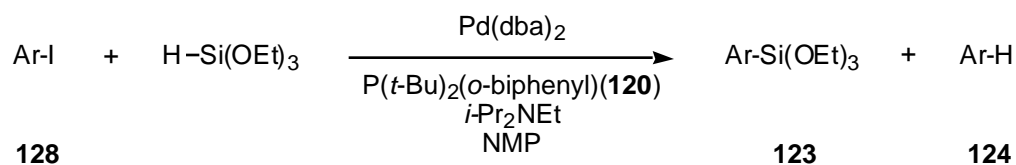
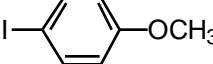
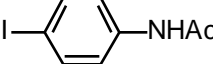
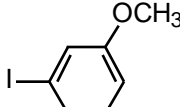
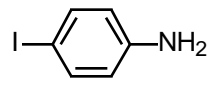
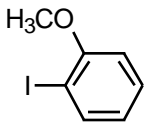
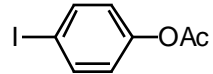
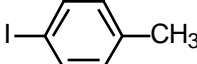
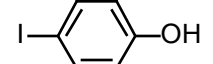
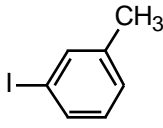
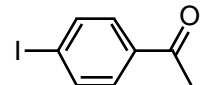
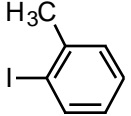
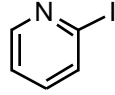
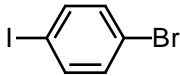
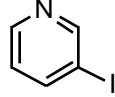
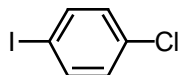
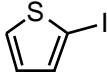

Figure 12. Proposed Effect of Substituent Position.

The modified reaction conditions were also applied to a variety of substituted aryl iodides in order to demonstrate the generality of the new ligand system and to determine the impact of arene substituent location on the silylation of iodides (Table 10). In agreement with the report of Masuda, electron-rich *para*-substituted aryl iodides underwent silylation more efficiently than the corresponding aryl bromides.²²¹ Similar yields of siloxanes were achieved with aryl iodides when either the $\text{Pd}(\text{dba})_2/\text{P}(t\text{-Bu})_2(o\text{-biphenyl})(\mathbf{120})$ system or Masuda's $\text{Pd}_2(\text{dba})_3\cdot\text{CHCl}_3/\text{P}(o\text{-tol})_3$ system was employed.

Aryl iodides were less sensitive to the electronic nature of the activating group than the corresponding bromides. For example, both 4-bromo (Table 10, entry 8) and 4-chloriodobenzene (entry 9) gave comparable yields of siloxane to electron-rich aryl iodides (i.e., *O*-, *N*-, and alkyl-substituted). In contrast, only electron-rich aryl bromide analogs underwent silylation under these conditions. In the case of 4-bromo-iodobenzene (entry 8), the reaction required close monitoring for consumption of starting material because dehalogenation of the desired product, 4-(triethoxysilyl)-bromobenzene, occurred under these conditions. Protection of other functionalities was unnecessary as shown by the excellent yields obtained with 4-iodoaniline (entry 11) and 4-iodophenol (entry 13). Prolonged reaction of iodoaniline not only lowered the yield of siloxane, but also affected silylation of the unprotected amine nitrogen.



Entry	Aryl Iodide (128)	% Yield (123) ^{a-c}	Entry	Aryl Iodide (128)	% Yield (123) ^{a-c}
1		86	10		68 ^e
2		52	11		77 ^e
3		10	12		75 ^e
4		80	13		70 ^d
6		65	14		24
7		0 ^d	15		0 ^{d,g}
8		68 ^{e,f}	16		10
9		75 ^e	17		92

^a Reactions of aryl iodide (**128**) (1.0 equiv) with H-Si(OEt)₃ (1.5 equiv) were allowed to stir at 60 °C for 12 h in NMP using Pd(dba)₂ (3 mol %), (t-Bu)₂P(o-biphenyl) (**120**) (6 mol %), and *i*-Pr₂NEt (3 equiv). ^b Yields shown in parentheses are GC yields; all other yields are isolated yields of purified (>95%) product. ^c Unless noted otherwise, the remaining percentage was of reduced starting material (**124**). ^d Yield confirmed by GCMS.

^e Reaction allowed to stir at room temperature. ^f Reaction stopped at 2 h. ^g Dipyrindyl was isolated in 15% yield.

Table 10. Palladium-Catalyzed Silylation of Aryl Iodides.

In contrast to the electron-rich aryl iodide systems, 4-iodoacetophenone was silylated in only 24% yield (entry 14) (see other examples in Masuda²²¹). Recall that the bromo analog failed to be silylated under these conditions (Table 7, entry 9). It is noteworthy that even the low yield was a triumph since this acetophenone analog cannot be synthesized by the organometallic approach (*vide supra*) due to the presence of the reactive carbonyl group. Once again, the position of the substituent greatly impacted the reaction outcome: *ortho*-iodoanisole (Table 9, entry 3) or toluene (entry 7) gave poor yields of product (10%, and 0%, respectively); whereas their *meta*- and *para*-iodo arene counterparts gave acceptable yields.

The results from silylation of 2- and 3-iodopyridine are notable. While in all previous examples the Pd-mediated silylation reaction yielded either aryl siloxane or reduced starting material (Scheme 60), homocoupling of 2-iodopyridine was observed. The homocoupled product [2,2']Bipyridinyl (**130**, Scheme 61) was isolated in 15% yield from the attempted silylation of 2-iodopyridine (the reaction went to completion, with pyridine as the only other product). The homocoupling of 2-halopyridines in the presence of a palladium catalyst is a known reaction.²⁴⁹⁻²⁵¹ As a control, 2-iodopyridine was exposed to the standard silylation conditions *in the absence of triethoxysilane*, and [2, 2']dipyridyl (**130**) was isolated in quantitative yield (Scheme 61). In contrast, when 2-bromopyridine was used in the control experiment, only a trace amount of the homocoupled product **130** was formed. The remainder of the reaction mixture was starting material. The results of the control experiments explain why no homocoupled product was observed in the attempted silylation of 2-bromopyridine, whereas homocoupling was a significant side-reaction in the silylation of 2-iodopyridine.

Scheme 61

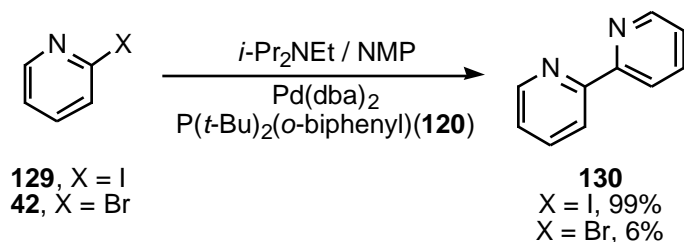

Attempts to silylate 3-iodopyridine were problematic also, although no homocoupled adduct was observed. We obtained only 10% of the desired product using either Masuda's conditions or our modified reaction conditions (Table 10, entry 16). These results were surprising because Masuda reported a 56% yield of 3-(triethoxysilyl)pyridine using $\text{Pd}_2(\text{dba})_3\cdot\text{CHCl}_3/\text{P}(o\text{-tol})_3$ in NMP (1h, 80 °C).²²¹ Again it appears that the metal coordinating ability of the pyridine nucleus is the culprit since 2-iodothiophene was readily silylated (92% yield, Table 9, entry 17).

Aryl triflates are appealing substrates for silylation since they are readily derived from the phenol,⁷¹ and are often more available than the corresponding aryl halides. However, aryl triflates failed to undergo efficient silylation under the standard conditions used for aryl iodides and bromides (Table 11). As seen in entries 1 and 9, electron-rich and deficient aryl triflates underwent reduction upon treatment with excess Hunig's base and triethoxysilane with catalytic $\text{Pd}(\text{dba})_2/\text{P}(t\text{-Bu})_2(o\text{-biphenyl})(\mathbf{120})$. A base was required for complete reaction turnover (entries 2,4,10, and 12), and the reaction tolerated both polar and non-polar solvents. The electron-rich substrate 4-methoxyphenyl triflate underwent reduction most efficiently using the alternative Buchwald ligand, $\text{P}(\text{cy})_2(o\text{-biphenyl})$ (entry 8), whereas the electron-deficient substrate 4-nitrophenyl triflate tolerated a range of phosphine ligands: $\text{P}(t\text{-Bu})_2(o\text{-biphenyl})$ (**120**), $\text{P}(\text{cy})_2(o\text{-biphenyl})$, and PPh_3 all affected efficient reduction.

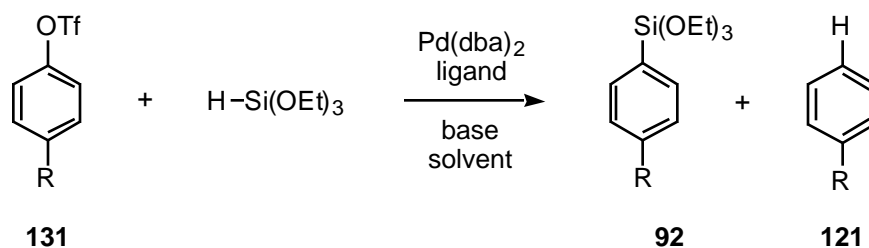

Entry	Conditions ^a				Yield (%) ^{b,c}	
	R	Ligand	Base	Solvent	92	121
1	OMe	P(<i>t</i> -Bu) ₂ (<i>o</i> -biphenyl)	<i>i</i> -Pr ₂ NEt	NMP	3	90
2	OMe	P(<i>t</i> -Bu) ₂ (<i>o</i> -biphenyl)	none	NMP	0	5
3	OMe	P(<i>t</i> -Bu) ₂ (<i>o</i> -biphenyl)	<i>i</i> -Pr ₂ NEt	dioxane	2	96
4	OMe	P(<i>t</i> -Bu) ₂ (<i>o</i> -biphenyl)	none	dioxane	0	7
5	OMe	PPh ₃	<i>i</i> -Pr ₂ NEt	NMP	0	5
6	OMe	PPh ₃	<i>i</i> -Pr ₂ NEt	dioxane	0	24
7	OMe	P(cy) ₂ (<i>o</i> -biphenyl)	<i>i</i> -Pr ₂ NEt	NMP	1	32
8	OMe	P(cy) ₂ (<i>o</i> -biphenyl)	<i>i</i> -Pr ₂ NEt	dioxane	1	99
9	NO ₂	P(<i>t</i> -Bu) ₂ (<i>o</i> -biphenyl)	<i>i</i> -Pr ₂ NEt	NMP	0	100
10	NO ₂	P(<i>t</i> -Bu) ₂ (<i>o</i> -biphenyl)	none	NMP	0	22
11	NO ₂	P(<i>t</i> -Bu) ₂ (<i>o</i> -biphenyl)	<i>i</i> -Pr ₂ NEt	dioxane	0	100
12	NO ₂	P(<i>t</i> -Bu) ₂ (<i>o</i> -biphenyl)	none	dioxane	0	15
13	NO ₂	PPh ₃	<i>i</i> -Pr ₂ NEt	NMP	0	100
14	NO ₂	PPh ₃	<i>i</i> -Pr ₂ NEt	dioxane	0	100
15	NO ₂	P(cy) ₂ (<i>o</i> -biphenyl)	<i>i</i> -Pr ₂ NEt	NMP	0	100
16	NO ₂	P(cy) ₂ (<i>o</i> -biphenyl)	<i>i</i> -Pr ₂ NEt	dioxane	0	100

^a Reactions of aryltriflate (**131**) (1.0 mmol) with H-Si(OEt)₃ (1.5 mmol) were performed at room temperature for 12h in 4 mL of solvent by using Pd(dba)₂ (5 mol %), phosphine (10 mol %), and base (3 mmol). ^b GC yields are based on amount of aryltriflate (**131**).

^c Remaining percentage was unreacted starting material.

Table 11. Silylation of Aryltriflate Derivatives.

The Pd-catalyzed reduction of aryl triflates using triethylsilane (Et₃Si-H) was reported by Kotsuki in 1995 (Scheme 62).²⁵² Under mild conditions, a variety of aryl triflates underwent deoxygenation in excellent yield. It was observed that triethylamine increased the reaction rate. With further optimization, triflate deoxygenation using H-Si(OEt)₃ in dioxane (or other volatile, low-polarity solvents such as THF or toluene) under our conditions could prove to be synthetically useful, and more attractive than existing methods, which require DMF.²⁵²

Scheme 62

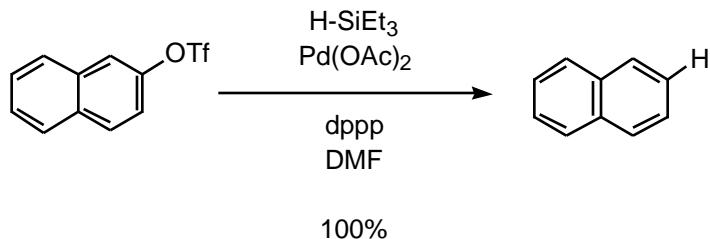

Two mechanisms have been proposed for the palladium-catalyzed silylation reaction, both of which account for the formation of reduced arene byproducts.²²¹ Both the C-X bond of aryl halides and the Si-H bond of silanes are known to undergo oxidative addition to Pd(0) complexes.^{45,253-258} Thus, two logical mechanisms have been proposed, one with Ar-Pd(II)-X, and the other with R₃Si-Pd(II)-H as the key intermediate, respectively.

Scheme 63 illustrates a reasonable mechanism for the oxidative addition of the aryl halide to Pd(0), to form Ar-Pd(II)-X complex **132**. Transmetalation with the silane forms four-centered palladium intermediate **133**, which in turn undergoes reductive elimination to liberate aryl silane and regenerate the Pd(0) catalyst. Support for this mechanism was provided by Chatgililoglu, who demonstrated that organic halides underwent oxidative addition to Pd(0) catalysts more readily than hydrosilanes.²⁵⁵ Additionally, it was shown that the mechanism did not involve the intermediacy of carbenium ions or free-radical species.

Scheme 63

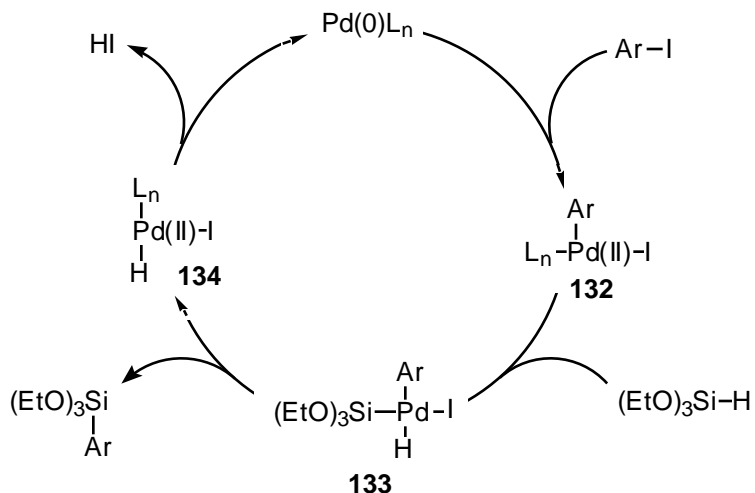

A mechanism involving oxidative addition of the hydrosilane followed by σ -bond metathesis has been proposed by Kunai and Ishikawa for the exchange of the Si-H and C-I bonds of alkyl and aryl iodides and hydrosilanes in the presence of a Pd(0) catalyst (Scheme 64).²⁵⁸ The mechanism for silylation begins with formation of a Si-Pd bond by oxidative addition of Pd(0) to the silane. Silylation of the aryl halide results from σ -bond metathesis, for overall Si-H/C-I bond exchange and regeneration of the Pd(0) catalyst.

Scheme 64

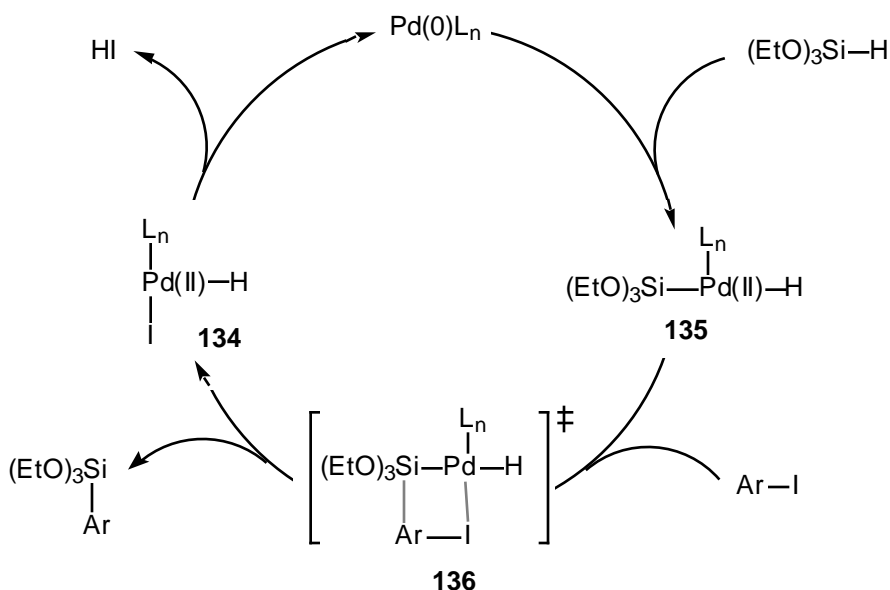

Both mechanisms account for the formation of dehalogenated aryl halide substrate when *ortho* substituents are present on the arene. Reductive elimination of silylated arene (Ar-Si(OEt)_3) from 4-coordinate Pd intermediate **133** requires that the $-\text{Si(OEt)}_3$ and the $-\text{Ar}$ ligands adopt a *cis* geometry, as shown above in Scheme 64. Steric bulk on the arene will disfavor the *cis* conformation, and isomerization of the complex reorients the two largest substituents to the *trans* geometry on the palladium complex (**137**, Scheme 65). As a consequence, the Ar- and H- ligands are placed preferentially *cis*, and Ar-H is formed upon reductive elimination from palladium.

Scheme 65

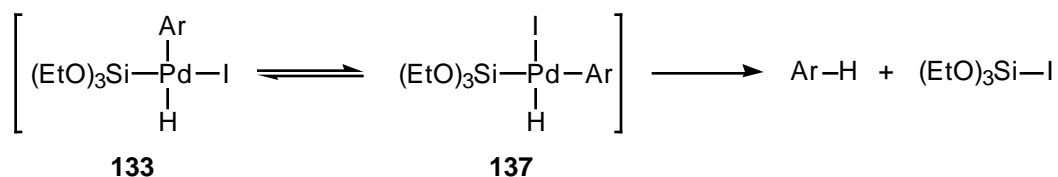

Similarly, for the proposed mechanism entailing σ -bond metathesis, steric bulk on the arene will disfavor the approach of Ar-X on the $\text{R}_3\text{Si-Pd(II)-H}$ intermediate which places the large arene adjacent to the bulky $-\text{SiR}_3$ ligand, as shown in transition state **136** in Figure 13. Instead, the less sterically demanding approach **139** should be favored, and formation of Ar-H in lieu of the desired Ar-SiR₃ results.

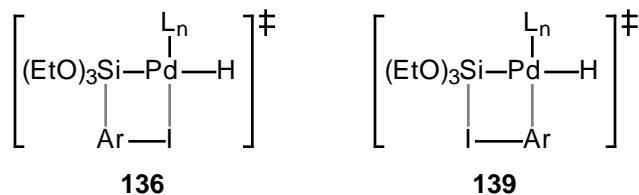

Figure 13. Proposed Transition States for the Metathesis Reaction Mechanism.

In order to determine which of the above two mechanisms most likely is at play in this process, Masuda demonstrated that neither silylation nor reduction occurred when a preformed Ar-Pd(II)-I complex was treated with $(\text{EtO})_3\text{SiH}$ and triethylamine, indicating that the mechanism of reaction likely does not involve initial oxidative addition to the aryl halide.²²¹ Instead, the latter mechanism entailing initial oxidative addition into the silane, followed by σ -bond metathesis seems the most likely pathway for the formation of aryl siloxane product.

In an effort to circumvent formation of reduced arene byproducts, the silylation reaction was attempted using hexamethoxydisilane $((\text{MeO})_3\text{Si-Si}(\text{OMe})_3)$ (Scheme 66). Alkylchloro- and alkylalkoxydisilanes had been shown previously to participate in the Pd-mediated silylation of aryl halides (*vide supra*).^{45,197,198,257,259-267} It is notable that the

analogous Pd-mediated process using hexachlorodisilane did not yield trichlorosilyl arenes (which could be converted to the siloxane upon alcoholysis).²⁶⁵

Scheme 66

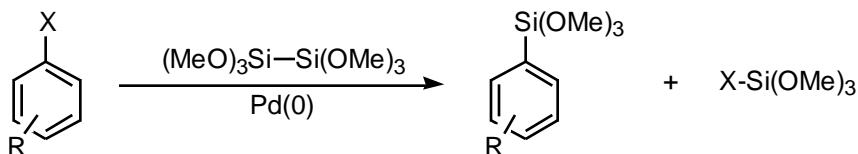

Unfortunately, aryl halides failed to undergo silylation using hexamethoxydisilane under the conditions used for the silylation of aryl iodides and bromides with hydrosilane (Table 12). Under standard silylation conditions, no reaction was observed with electron-rich *p*-haloanisole derivatives (entries 1-4). In contrast, the electron-deficient system of 4-bromoacetophenone underwent complete reduction using standard as well as modified silylation conditions (entries 5 to 9).

Hatanaka reported the palladium-mediated, fluoride-induced trimethylsilylation of electron-rich and electron-neutral aryl iodides with hexamethyldisilane (Scheme 67). Under the same conditions reported by Hatanaka using hexamethoxysilane, no reaction was observed (Table 12, entries 10-12). Finally, the best results were obtained under forced reaction conditions (entry 13): treatment of bromobenzene with hexamethoxydisilane for 72 hours in a sealed tube at 140 °C in the presence of catalytic $\text{Pd}(0)$ yielded 27% of the desired silane, as well as reduced arene and biphenyl contaminants.

Scheme 67

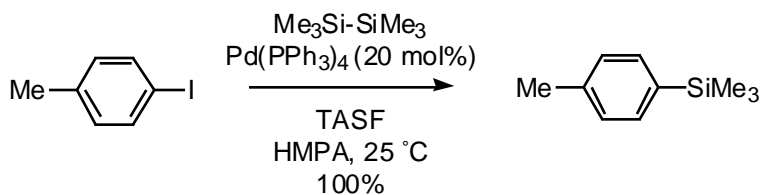

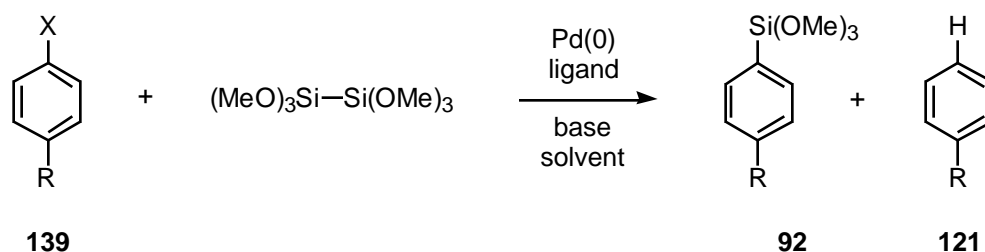

Entry	Substrate		Conditions ^a				Yield (%) ^{b,c}	
	X	R	Ligand	Pd catalyst / base	solvent	T (°C)	92	121
1	I	OMe	P(<i>t</i> -Bu) ₂ (<i>o</i> -biphenyl)	Pd(dba) ₂ / <i>i</i> -Pr ₂ NEt	NMP	25	0	0
2	I	OMe	P(<i>o</i> -tol) ₃	Pd(dba) ₂ ·CHCl ₃ / <i>i</i> -Pr ₂ NEt	NMP	25	0	2
3	Br	OMe	P(<i>t</i> -Bu) ₂ (<i>o</i> -biphenyl)	Pd(dba) ₂ / <i>i</i> -Pr ₂ NEt	NMP	25	0	0
4	Cl	OMe	P(<i>t</i> -Bu) ₂ (<i>o</i> -biphenyl)	Pd(dba) ₂ / <i>i</i> -Pr ₂ NEt	NMP	25	0	0
5	Br	Ac	P(<i>t</i> -Bu) ₂ (<i>o</i> -biphenyl)	Pd(dba) ₂ / <i>i</i> -Pr ₂ NEt	NMP	100	0	100
6	Br	Ac	P(<i>t</i> -Bu) ₂ (<i>o</i> -biphenyl)	Pd(dba) ₂ / <i>i</i> -Pr ₂ NEt	DMPU	100	0	100
7	I	Ac	P(<i>t</i> -Bu) ₂ (<i>o</i> -biphenyl)	Pd(dba) ₂ / KF (aq)	DMPU	75	0	100
8	Br	Ac	P(<i>t</i> -Bu) ₂ (<i>o</i> -biphenyl)	Pd(dba) ₂ / KF (aq)	DMPU	75	0	100
9	Br	OMe	P(<i>t</i> -Bu) ₂ (<i>o</i> -biphenyl)	Pd(dba) ₂ / K ₂ CO ₃ (aq)	DMPU	75	0	0
10	I	OMe		Pd(PPh ₃) ₄ / TBAF	NMP	25	0	0
11	I	Me		Pd(PPh ₃) ₄ / TBAF	DMF	25	0	3
12	I	Me		Pd(PPh ₃) ₄ / TBAF	HMPA	25	0	3
13 ^{d,e}	Br	H		Pd(PPh ₃) ₄	toluene	140	27	10

^a Reactions of aryl halide **139** (1.0 equiv) with (MeO)₃Si-Si(OMe)₃ (2.0 equiv) were performed using the indicated temperature and solvent for 12h-48h by using the given palladium catalyst (5 mol %), phosphine (10 mol %), and base (3 equiv). ^b GC yields are based on amount of aryl halide **139**. ^c Unless otherwise noted, remaining percentage was unreacted starting material (**139**). ^d Reaction was performed in a sealed tube for 72h. ^e Biphenyl was observed in 7% yield.

Table 12. Silylation of Arylhalides Using Hexamethoxydisilane.

The results of the silylation reaction employing hexamethoxydisilane are surprising. In the absence of a hydride source, it was anticipated that reduction of the aryl halide would be suppressed. One possible hydrogen atom source is methoxide, which can be generated upon decomposition of the disilane under the harsh reaction conditions.¹⁹⁸ Previous researchers have demonstrated the catalytic dehalogenation of a large variety of aryl chlorides and bromides with sodium or potassium methoxide mediated by Pd(0) (Scheme 68).²⁶⁸

Scheme 68

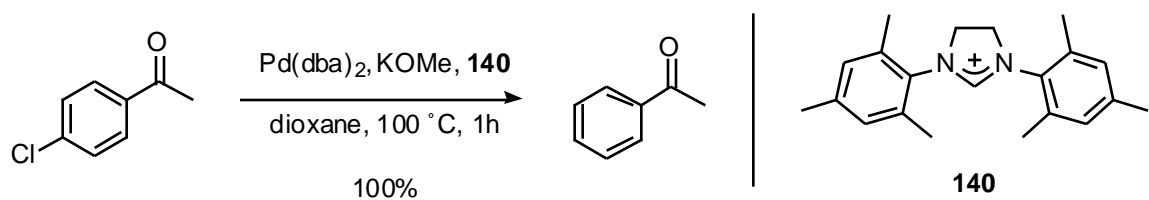

The proposed mechanism of dehalogenation by methoxide under palladium catalysis is depicted in Scheme 69.²⁶⁸ The mechanism begins with oxidative addition of the aryl halide to Pd(0) to form the Ar-Pd(II)-X intermediate **132**, followed by methoxide attack with displacement of the halide to give key intermediate **141**. Then, β -hydride elimination and liberation of formaldehyde gives the palladium-hydride complex **134**, which can reductively eliminate reduced arene and regenerate the catalyst.

Scheme 69

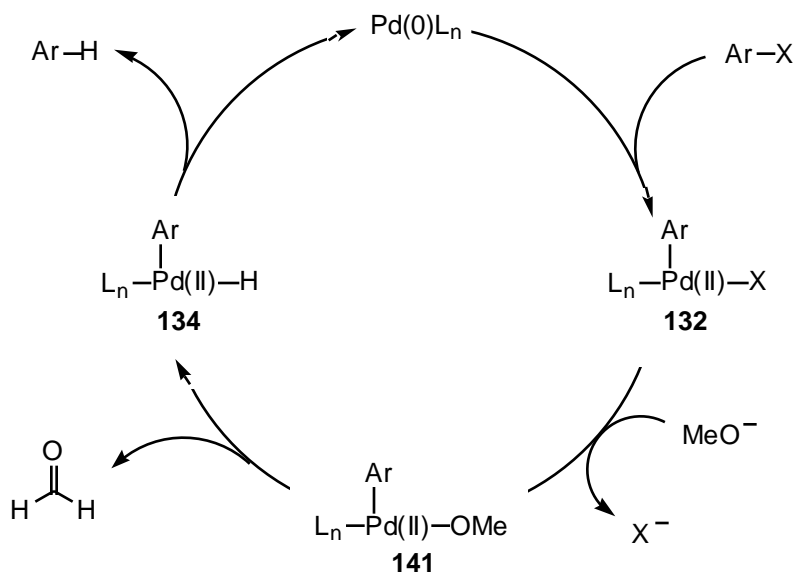

Rich pioneered the use of aryl acyl chloride derivatives as substrates for silylation (Scheme 70).^{196,269,270} For example, treatment of *m*-nitrobenzoyl chloride (**142**) with 1,1,2,2-dichlorodimethyldisilane under palladium catalysis resulted in decarbonylative silylation to form aryl silane **143**.¹⁹⁶

Scheme 70

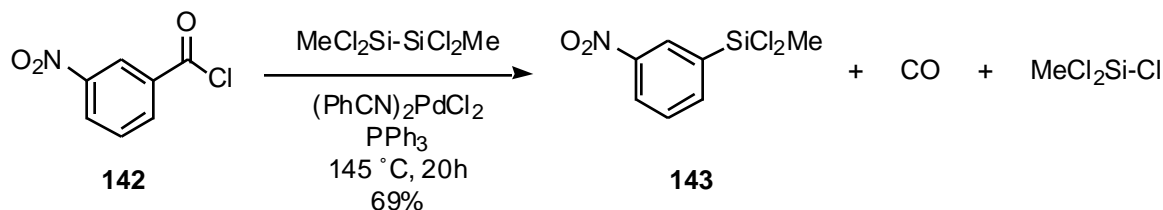

Rich demonstrated the efficient silylation of *para* and *meta*-substituted electron rich and deficient aromatic acid chlorides utilizing methylchlorosilanes; *ortho*-substituted acid chlorides failed to undergo carbonylative silylation.¹⁹⁶ It is notable that the analogous method using hexachlorodisilane did not successfully form trichlorosilyl arenes (which could be converted to the siloxane upon alcoholysis). Rich reported that hexachlorodisilane underwent decomposition under the conditions of the reaction. Lastly, a number of byproducts were observed, including benzil and diarylketone derivatives, especially when electron-deficient substrates were employed.

The decarbonylative silylation reaction as reported by Rich was attempted in our laboratories, using hexamethoxydisilane (Scheme 71, eqn. a). Benzoyl chloride was heated without solvent in a sealed tube with hexamethoxydisilane and (PhCN)₂PdCl₂ in the presence of triphenylphosphine. However, none of the desired product was formed; instead, quantitative formation of methylbenzoate was observed. Clearly, the harsh reaction conditions elicited formation of methoxide *via* decomposition of the disilane, resulting in the methanolysis of the acyl chloride moiety. The thermal decomposition of chloro¹⁹⁶ and alkoxy¹⁹⁸ disilanes was reported, previously. Formation of arylsilane was observed when a different catalyst was employed (Scheme 71, eqn. b), however formation of the methyl ester was still a significant side-reaction. Less harsh reaction

conditions resulted in no reaction. Efforts to employ the disilane for the synthesis of aryl siloxanes from aryl halides and acyl chlorides were abandoned in light of the poor results of these preliminary studies, the expense of the disilane reagent, and the harsh reaction conditions.

Scheme 71

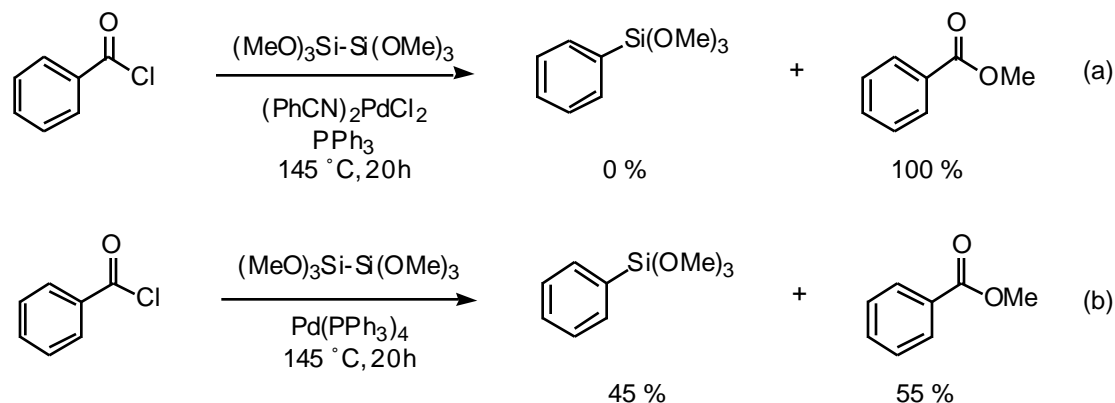

In summary, the Pd-mediated silylation of electron-rich aryl halides has been extended to include both iodides and bromides. For bromo arenes, the inclusion of Buchwald's phosphine ligand (**120**) is crucial. Although aryl iodides remain the substrates of choice for silylation, an acceptable yield of arylsiloxane may be obtained from the corresponding bromide. This is an advantage since aryl bromides are generally less expensive and more widely available than the analogous aryl iodides.

Conclusions

The scope of the silylation protocol has been fully defined: the synthesis of aryl and heteroaryl siloxanes using $\text{H-Si}(\text{OEt})_3$ and a Pd catalyst is limited generally to electron-rich, *para*- and *meta*-substituted aryl bromides and iodides. Aryl chlorides were inert under the reaction conditions, and triflates were poor substrates for silylation, instead undergoing highly efficient reductive deoxygenation. The optimum silylation reagent is triethoxysilane. This silylation method is an excellent companion to the more traditional organometallic approach to the formation of the Ar-Si bond. Case in point, *ortho*-substituted aryl siloxanes are readily synthesized from the Grignard or lithium reagent.

Unlike the metallation approach, the Pd-catalyzed silylation technique can be performed in the presence of a wide range of functional groups, including carbonyl-containing electrophiles, and protic moieties such as phenols or primary amines.

To date, a large variety of simple aryl and heteroaryl halides has been shown to undergo silylation by one or both of the above protocols (Figure 14).^{24,25,68,111,229}

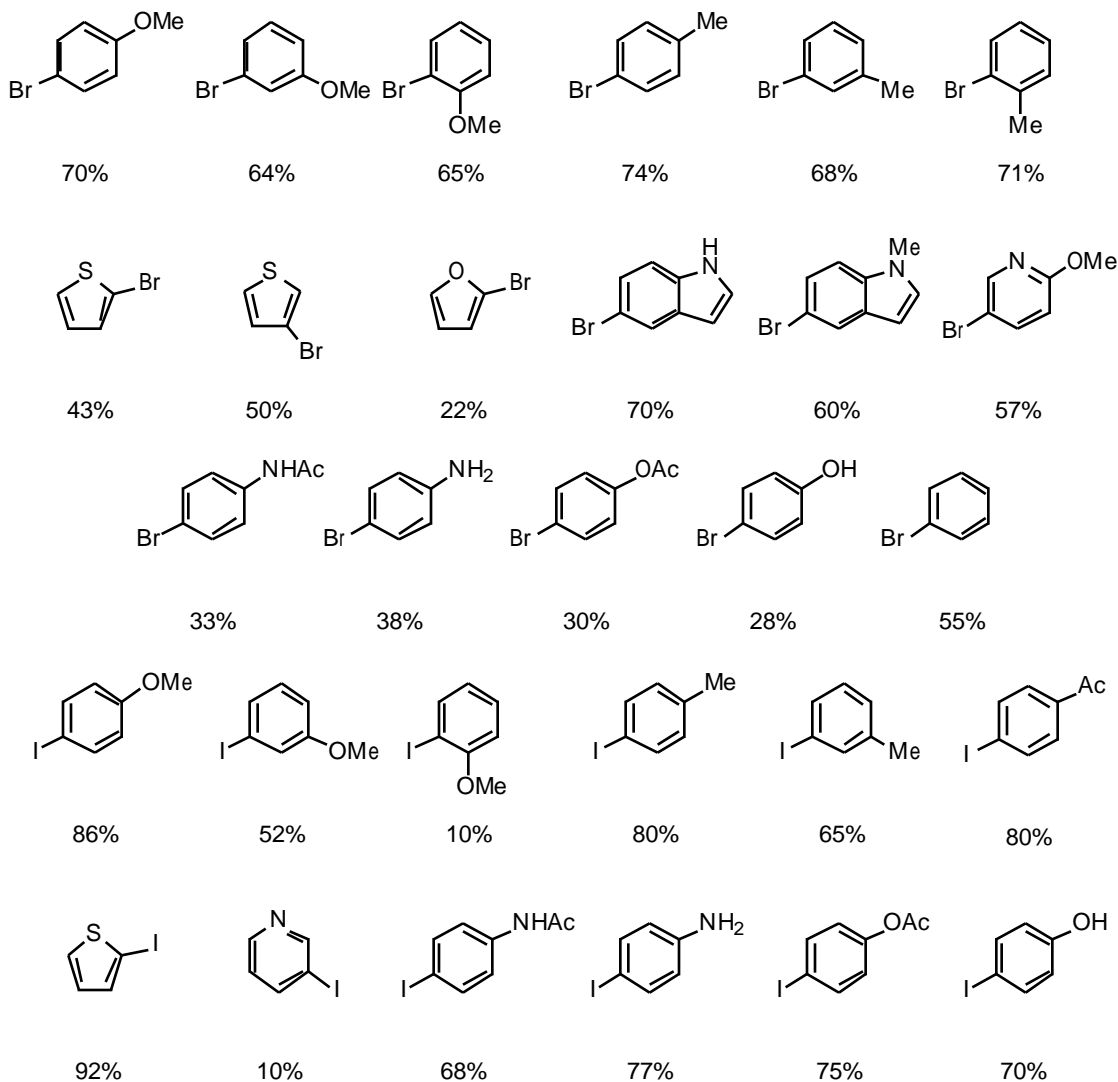

Figure 14. Yields of Siloxanes Using Arylmetaloid Reagents or Palladium-Mediated Silylation.

The siloxane derivatives synthesized by the methods described herein have been utilized in palladium-catalyzed cross-coupling. The synthesis of aryl siloxanes has been shown to be comparable in yield to the synthesis of aryl boron reagents. In

contrast to the Suzuki reagents, siloxanes are easily purified by chromatography, distillation, or even recrystallization (in the case of aryl catecholates and silatranes). Although aryl tin reagents remain the easiest to synthesize, the silicon-based cross-coupling technique is an attractive alternative to Stille coupling, due to the low toxicity of the siloxane cross-coupling reagents.

Application of these methodologies to the synthesis of complex, biologically active materials has been investigated in our laboratory. For example, the synthesis of a variety of highly functionalized siloxane derivatives has been accomplished. Coupling of these siloxanes to provide intermediates in the total synthesis of pancratistatin, streptonigrin, lavendamycin, and colchicine are being investigated by other members of the group and these results will be reported in due course. A sample of highly functionalized siloxanes prepared by these methods includes **93**, **94**, **142** and **143** (Figure 15).

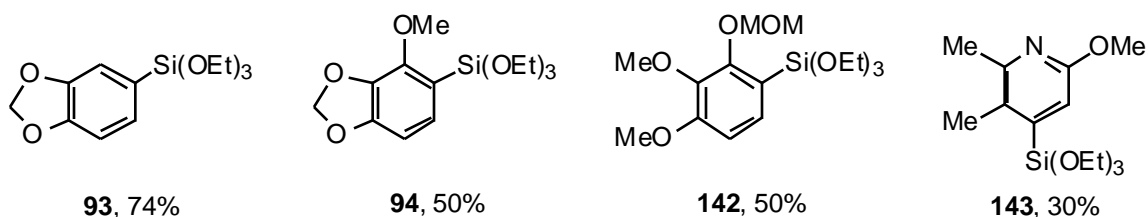

Figure 15. Siloxane Intermediates for Use In Natural Product Syntheses.

Epilogue

Since the publication of the above method for aryl siloxane synthesis *via* Pd(0)-catalyzed silylation of aryl bromides and iodides in 2001,²⁷¹ Masuda reported the Rh(I)-catalyzed silylation of aryl iodides and bromides (Scheme 72).²⁷² The silylation is analogous to the Pd(0) silylation, in that the reaction requires a tertiary amine and polar amide solvent. Again, dehalogenation of the aryl halide starting material was the major side-reaction. Significantly, the substitution of Rh(I) for Pd(0) as the catalyst allowed for the silylation of electron-deficient aryl halides, as well as hindered, *ortho*-substituted silanes. The Rh(I)-catalyzed process is limited by expense of, and the need to

synthesize the $[\text{Rh}(\text{cod})(\text{MeCN})_2]\text{BF}_4$ catalyst, but nonetheless presents a general method of silylation, encompassing electron-rich as well as electron-deficient aryl halides, including *ortho*-substituted arenes. The silylation of chloro arenes remains elusive.

Scheme 72

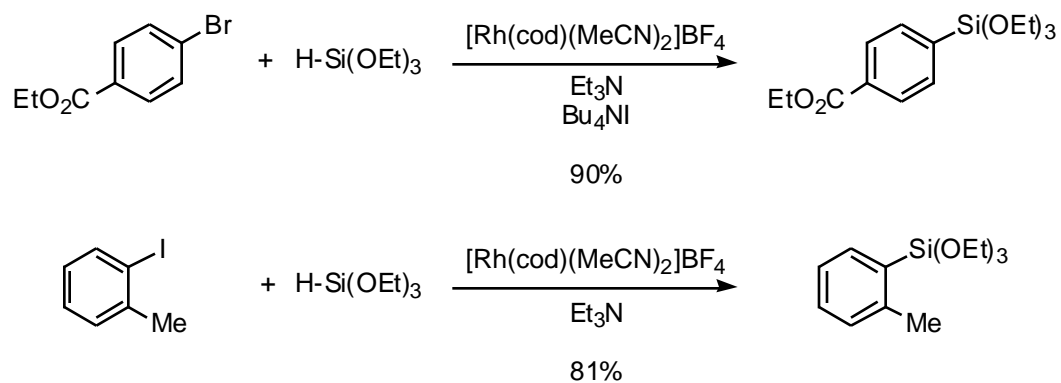

Experimental

General. Thin layer chromatography (TLC) was performed on 0.25 mm Merck silica-coated glass plates treated with a UV-active binder, with the compounds being visualized in one or more of the following manners: UV (254 nm), iodine, or vanillin/sulfuric acid charring. Flash chromatography was performed using thick-walled glass columns and medium-pressure silica gel (Davisil® 200-425 mesh) as described by Still.²⁷³ Flash chromatography data is reported as: (column diameter in mm, column height in cm, solvent).

Infrared spectra were recorded on a Nicolet 5DXC FT-IR spectrophotometer with the samples prepared as stated. Band positions are given in reciprocal centimeters (cm^{-1}) and relative intensities are listed as br (broad), vs (very strong), s (strong), m (medium), or w (weak).

Melting points were taken in Kimax soft glass capillary tubes using a Thomas-Hoover Uni-Melt capillary melting point apparatus (Model 6406K) equipped with a calibrated thermometer. Melting points are corrected.

Nuclear magnetic resonance (^1H , ^{13}C) spectra were recorded on a Bruker DRX-400 spectrometer. Chemical shifts are reported in parts per million (δ) downfield from tetramethylsilane (TMS). Coupling constants (J values) are reported in Hertz (Hz), and spin multiplicities are indicated by the following symbols: s (singlet), d (doublet), t (triplet), q (quartet), m (multiplet), br s (broad singlet).

Low resolution (MS) and high resolution mass spectra (HRMS) were obtained on a VG-7070E magnetic sector instrument equipped with a 486 PC-based data system. GCMS was performed on a Shimadzu QP5000MS coupled with a GC17A gas chromatograph.

Gas chromatography was performed on a Hewlett Packard 5890 GC equipped with a flame ionization detector using a 25 m methyl silicon column.

Methylene chloride (CH_2Cl_2), tetraethyl orthosilicate ($\text{Si}(\text{OEt})_4$), tetramethyl orthosilicate ($\text{Si}(\text{OMe})_4$), methyl sulfoxide (DMSO), dimethyl formamide (DMF), 1-methyl-2-pyrrolidinone (NMP), toluene, pyridine, and acetonitrile (MeCN) were each distilled from calcium hydride. Tetrahydrofuran (THF), dioxane and diethyl ether (Et_2O) were each distilled from sodium-benzophenone ketyl. Methanol (MeOH) and ethanol (EtOH) were stored over molecular sieves.

Palladium(II) acetate ($\text{Pd}(\text{OAc})_2$), bis(dibenzylideneacetone)palladium ($\text{Pd}(\text{dba})_2$), dichlorobis(triphenylphosphine)palladium(II) ($\text{PdCl}_2(\text{PPh}_3)_2$), and tetrakis(triphenylphosphine)palladium(0) ($\text{Pd}(\text{PPh}_3)_4$) were purchased from Acros and used as received.

Tri-*o*-tolylphosphine ($\text{P}(\text{o-tol})_3$) was purchased from Acros and used as received. Triphenylphosphine (PPh_3) was purchased from Aldrich and recrystallized from hexanes prior to use. 2-(Di-*t*-butylphosphino)biphenyl (**120**) ($\text{P}(\textit{t-Bu})_2(\text{o-biphenyl})$) was purchased from Strem and recrystallized from methanol (MeOH) prior to use. The ligand 2-(Dicyclohexylphosphino)biphenyl ($\text{P}(\text{cy})_2(\text{o-biphenyl})$) was purchased from Strem and recrystallized from absolute ethanol (EtOH) prior to use. Tri-*t*-butylphosphino ($\text{P}(\textit{t-Bu})_3$) was purchased from Strem as a 10 wt% solution in hexane and stored under argon. All other phosphines and triphenylarsine were purchased from Aldrich, stored under argon, and used as received.

Aryl halides, heteroaryl halides and alkyl halides were prepared by literature procedure as noted, or purchased from Acros or Aldrich and purified using the method of Perrin²⁷⁴ prior to use. *N*-(4-Bromophenyl) acetamide²⁷⁵, 4-acetoxybromobenzene²⁷⁶, 4-acetoxyiodobenzene²⁷⁶, 2-iodopyridine²⁷⁷, 3-iodopyridine²⁷⁸, 2-bromoquinoline²⁷⁹, 3-bromoquinoline²⁸⁰, and 5-bromo-2-methoxypyridine²⁸¹ were each prepared according to the literature procedure. In the case aryl sulfonates, the appropriate sulfonate was synthesized from the phenol immediately before use using the literature method^{283,284} and the crude isolated sulfonate was used without further purification. Triethoxysilane

(H-Si(OEt)₃), and diisopropylethylamine (*i*-Pr₂NEt), were purchased from Aldrich, stored in a dessicator, and used as received. Triisopropoxysilane (H-Si(O-*i*Pr)₃) and hexamethoxydisiloxane ((MeO)₃Si-Si(OMe)₃) were purchased from Gelest, stored in a dessicator, and used as received. Tetrabutylammonium fluoride (TBAF) was purchased from Acros as a 1.0 M solution in THF and used as received. Tetrabutylammonium triphenyldifluorosilicate (TBAT) was prepared according to the literature procedure.²⁸⁵

n-Butyllithium (1.6 M solution in hexane), and *t*-butyllithium (1.5 M solution in pentane) were purchased from Acros and used as received. The alkyllithium concentration was confirmed by titration with diphenylacetic acid using the method of Kofron.²⁸⁶ Magnesium turnings were cleaned as follows: enough turnings were placed in a beaker to form a thin layer. Dilute HCl solution (0.1 M) was added to just cover the magnesium turnings. The turnings were stirred until bubbling ceased and then the solution was decanted off and the process repeated three times or until the metal had a shiny mirror appearance. The turnings were then washed in the beaker three times each with water, ethanol, and diethyl ether. Finally, the turnings were dried in an oven at 120 °C for five minutes.

Glassware used in the reactions described below was dried for a minimum of 12 h in an oven at 120 °C. All reactions were run under an atmosphere of nitrogen or argon at room temperature unless otherwise noted.

All compounds were determined to be >95% pure by ¹H NMR unless otherwise noted.

General Procedure for the Optimization of the Synthesis of 4-

(Triethoxysilyl)anisole (88) Using 4-Bromomagnesium anisole (87) (Table 2). A 10 mL, 3-neck pear-shaped flask was fitted with an addition funnel, a reflux condenser, a rubber septum, and a stirbar. The flask was then charged with freshly washed magnesium turnings (134 mg, 5.50 mmol), flame-dried under vacuum, and back-filled with argon. THF (1.0 mL) was added to the magnesium turnings *via* syringe. The addition funnel was charged with 4-bromoanisole (**86**) (935 mg, 628 μ L, 5.00 mmol) in 2.0 mL THF. The reaction was initiated by addition of 5-10 drops of the bromoanisole solution to the magnesium turnings with stirring, followed by gentle heating. The rest of the bromoanisole solution was then added at such a rate that the THF maintained a moderate reflux. Upon final addition, the solution was allowed to stir at room temperature for 1 h, at which point GC analysis of a quenched aliquot of the reaction mixture indicated complete consumption of 4-bromoanisole. The 4-(bromomagnesium)anisole solution was then transferred *via* cannula to a second flame-dried addition funnel, to which was fitted a 50 mL round-bottom flask containing the indicated silane (1.5-3.0 equiv) and the internal standard naphthalene (64 mg, 0.50 mmol) in 10.0 ml of THF. The silane solution was cooled to the indicated temperature, and then the 4-(bromomagnesium)anisole solution was added dropwise (1 drop per second). The solution was allowed to stir at the indicated temperature for 1 h, and then at room temperature for 12 h. Progress was monitored by GC analysis of aliquots of the quenched reaction mixture. GC response factors relative to the internal naphthalene standard were determined, and the observed percentages of products were normalized accordingly. The reduced product anisole was identified by comparison of the GC retention time to that of an authentic sample. Diarylated products were identified by GCMS; triarylated products were not observed. Aliquots of the crude, concentrated 4-(trichlorosilyl)anisole were converted to the siloxane by dropwise addition (1 drop per second) of the chlorosilane to EtOH/pyridine at 0 °C.

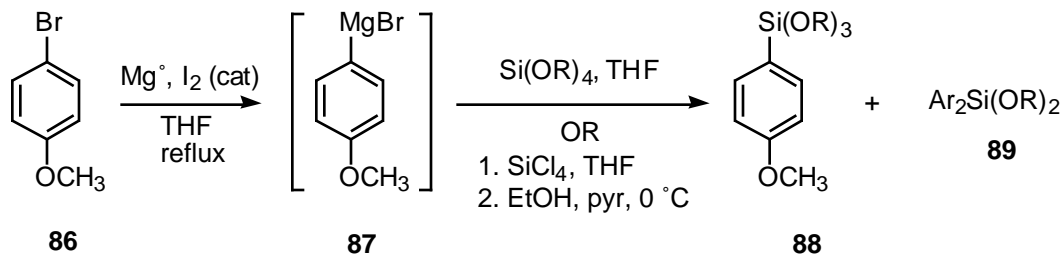

Entry	Conditions ^a		Yield (%) ^{b,c}	
	Silane / Equiv	T (°C)	88	89
1	Si(OMe) ₄ / 3.0	25	47	47
2	Si(OMe) ₄ / 3.0	-30	76	3
3	Si(OMe) ₄ / 1.5	-30	65	4
4	Si(OEt) ₄ / 3.0	0	72	23
5	Si(OEt) ₄ / 3.0	-10	70	23
6	Si(OEt) ₄ / 3.0	-30	83	3
7	Si(OEt) ₄ / 1.5	-30	76	2
8	Si(Cl) ₄ / 3.0 ^d	-30	70 ^d	3

^a Reactions of *p*-methoxy magnesium bromide **87** (1.0 equiv) with Si(OR)₄ or SiCl₄ (1.5 to 3.0 equiv) were allowed to stir at the given temperature in THF. The reaction mixture was stirred at the indicated temperature for 1 h, and then at room temperature for 12 h. ^b GC yields are based on amount of 4-bromoanisole (**86**). ^c The remainder of the product was of anisole. ^d Yield of 4-(triethoxysilyl)anisole (**88**). The crude, concentrated 4-(trichlorosilyl)anisole was converted to the siloxane **88** by dropwise addition of the chlorosilane to EtOH/pyridine at 0 °C.

Table 2. Optimization of the Synthesis of Arylsiloxanes Using 4-Bromomagnesium Anisole.

General Procedure for Synthesis of Siloxanes from Grignard Reagents (Table 3).

Unless otherwise indicated, all reactions were performed on a 5 mmol scale. A 10 mL, 3-neck pear-shaped flask was fitted with an addition funnel, a reflux condenser, a rubber septum, and a stirbar. The flask was then charged with freshly washed magnesium turnings (134 mg, 5.50 mmol), flame-dried under vacuum, and back-filled with argon. THF (1.0 mL) was added to the magnesium turnings via syringe. The addition funnel was charged with the aryl halide (5.00 mmol) in 2.0 mL THF. The reaction was initiated by addition of 5-10 drops of the aryl halide solution to the magnesium turnings with stirring,

followed by gentle heating. The rest of the aryl halide solution was then added at such a rate that the THF maintained a moderate reflux. Upon final addition, the solution was allowed to stir at room temperature until GC analysis of a quenched aliquot of the reaction mixture indicated complete consumption of aryl halide. The aryl magnesiumhalide solution was then transferred via cannula to a second flame-dried addition funnel, to which was fitted a 50 mL round-bottom flask containing tetraethyl orthosilicate or tetramethyl orthosilicate (15.00 mmol) in 10.0 ml of THF. The silane solution was cooled to $-30\text{ }^{\circ}\text{C}$, and then the 4-arylmagnesiumhalide solution was added dropwise (1 drop per second). The solution was allowed to stir at the indicated temperature for 1 h, and then at room temperature for 12 h. The crude reaction mixture was then poured into 50 mL of pentane in a 200 mL separatory funnel. The amber solution was washed with 3 x 25 mL water to remove the excess tetraalkoxysilane, dried over MgSO_4 , filtered, and concentrated in vacuo. Purification of the residue by bulb-to-bulb distillation yielded the siloxane.

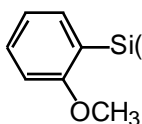

2-(Triethoxysilyl)anisole (Table 3, entry 1). The general

procedure for synthesis of siloxanes from Grignard reagents was followed using 2-bromoanisole (935 mg, 623 μL , 5.00 mmol), magnesium turnings (134 mg, 5.50 mmol), and tetraethyl orthosilicate (3.13 g, 3.35 mL, 15.0 mmol) in THF. Bulb-to-bulb distillation ($125\text{ }^{\circ}\text{C}$, 0.5 torr) afforded 1.19 g (88%) of 2-(triethoxysilyl)anisole as a colorless oil. IR (neat) 3067 (m), 2967 (s), 2922 (s), 2891 (s), 2829 (m), 2780 (w), 2762 (w), 1590 (s), 1569 (s), 1459 (s), 1241 (s) cm^{-1} ; ^1H (NMR) (CDCl_3) δ 1.21 (t, $J = 7.2$, 9H), 3.79 (s, 3H), 3.84 (q, $J = 7.2$, 6H), 6.83 (d, $J = 8.2$, 1H), 6.95 (t, $J = 7.2$, 1H), 7.38 (m, 1H), 7.63 (dd, $J = 1.6, 7.2$, 1H); ^{13}C (NMR) (CDCl_3) δ 18.2, 55.1, 58.7, 109.6, 119.2, 120.5, 132.2, 137.5, 164.3; MS (m/z) 271 ($\text{M}^+ + 1$, 42), 225 (100), 195 (21), 181 (36), 139 (25), 119 (21), 91 (24), 77 (14); HRMS for $\text{C}_{13}\text{H}_{23}\text{O}_4\text{Si}$ calcd 271.1366 ($\text{M}^+ + 1$), found 271.1354.

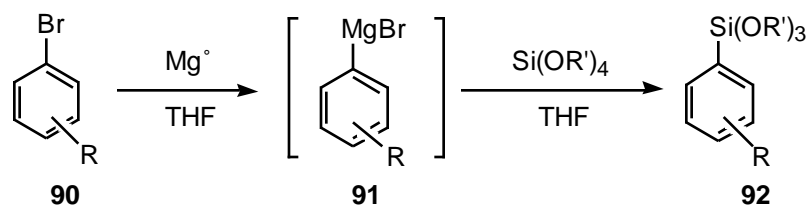

Entry	Aryl Siloxane	Yield (%) ^{a,b}	Entry	Aryl Siloxane	Yield (%) ^{a,b}
1		88	6		81
2		83	7		71
3		84	8		75
4		82	9		86
5		74	10		55

^a Reactions of arylmagnesium bromide **91** (1.0 equiv) with Si(OEt)₄ or Si(OMe)₄ (3.0 equiv) were allowed to stir at -30 °C in THF. The reaction mixture was stirred at -30 °C for 1 h, and then at room temperature for 12 h. ^b Yields of **92** are after distillation (purity >95%). The remainder of the product was of the reduced (dehalogenated) arene.

Table 3. Synthesis of Aryl(trialkoxy)silanes Using Grignard Reagents.

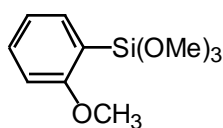

2-(Trimethoxysilyl)anisole (Table 3, entry 2). The general procedure for synthesis of siloxanes from Grignard reagents was followed using 2-bromoanisole (935 mg, 623 μ L, 5.00 mmol),

magnesium turnings (134 mg, 5.50 mmol), and tetramethyl orthosilicate (2.28 g, 2.21 mL, 15.0 mmol) in THF. Bulb-to-bulb distillation (125 °C, 0.5 torr) afforded 948 mg (83%) of 2-(trimethoxysilyl)anisole as a colorless oil. IR (¹H NMR) (CDCl₃) δ 3.61 (s, 9H), 3.80 (s, 3H), 6.87 (d, *J*=8.3, 1H), 6.97 (t, *J*=7.2, 1H), 7.42 (m, 1H), 7.59 (dd, *J*=1.7, 7.2, 1H); ¹³C NMR (CDCl₃) δ 50.4, 54.9, 109.4, 117.7, 120.3, 132.2, 137.0, 164.1; MS (*m/z*) 228 (100), 196 (61) 167 (55), 137 (18), 121 (44), 91 (45), 58 (29); HRMS for C₁₀H₁₆O₄Si calcd 228.0818, found 228.0809.

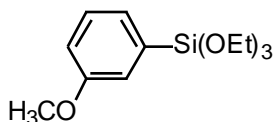

3-(Triethoxysilyl)anisole (Table 3, entry 3). The general procedure for synthesis of siloxanes from Grignard reagents was followed using 3-bromoanisole (935 mg, 633 μ L, 5.00 mmol), magnesium turnings (134 mg, 5.50 mmol), and tetraethyl orthosilicate (3.13 g, 3.35 mL, 15.0 mmol) in THF. Bulb-to-bulb distillation (125 $^{\circ}$ C, 0.5 torr) afforded 1.14 g (84%) of 3-(triethoxysilyl)anisole as a colorless oil. IR (neat) 2975 (s), 2927 (m), 2887 (m), 1572 (m), 1482 (w), 1410 (w), 1391 (w), 1284 (w), 1249 (m), 1234 (m), 1167 (m), 1078 (vs) cm^{-1} ; ^1H (NMR) (CDCl_3) δ 1.25 (t, $J = 7.0$, 9H), 3.81 (s, 3H), 3.87 (q, $J = 7.0$, 6H), 6.96-6.98 (m, 1H), 7.21-7.33 (m, 3H); ^{13}C (NMR) (CDCl_3) δ 18.3, 55.1, 58.8, 116.1, 119.8, 127.1, 129.2, 132.4, 159.0; MS (m/z) 270 (100), 256 (12), 255 (70), 226 (28), 225 (64), 211 (23), 197 (13), 182 (11), 181 (41), 169 (37), 168 (13), 167 (29), 163 (10), 154 (16), 153 (27), 149 (22), 147 (61), 139 (20), 137 (14), 136 (55), 135 (95); HRMS for $\text{C}_{13}\text{H}_{22}\text{O}_4\text{Si}$ calcd 270.1287, found 270.1282.

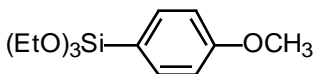

4-(Triethoxysilyl)anisole (Table 3, entry 4). The general procedure for synthesis of siloxanes from Grignard reagents was followed using 4-bromoanisole (935 mg, 626 μ L, 5.00 mmol), magnesium turnings (134 mg, 5.50 mmol), and tetraethyl orthosilicate (3.13 g, 3.35 mL, 15.0 mmol) in THF. Bulb-to-bulb distillation (125 $^{\circ}$ C, 0.5 torr) afforded 1.11g (82%) of 4-(triethoxysilyl)anisole as a colorless oil. IR (neat) 2975 (s), 2926 (m), 2894 (m), 1597 (s), 1505 (m), 1282 (m), 1249 (m), 1167 (s), 1127 (vs), 1104 (vs), 1080 (vs) cm^{-1} ; ^1H (NMR) (CDCl_3) δ 1.24 (t, $J = 7.0$, 9 H), 2.34 (s, 3H), 3.86 (q, $J = 7.0$, 6 H), 6.92 (d, $J = 8.6$, 2 H), 7.61 (d, $J = 8.6$, 2 H); ^{13}C (NMR) (CDCl_3) δ 18.1, 54.9, 58.6, 113.6, 122.0, 136.4, 161.4; MS (m/z) 270 (52), 255 (53), 225 (38), 211 (25), 181 (28), 169 (27), 149 (22), 147 (100), 135 (32); HRMS for $\text{C}_{13}\text{H}_{22}\text{O}_4\text{Si}$ calcd 270.1287, found 270.1261. The IR, ^1H and ^{13}C NMR data were identical to published spectral data.²²¹

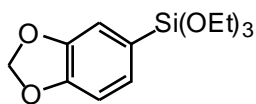

4-(Triethoxysilyl)-1,2-(methylenedioxy)benzene (Table 3, entry 5). The general procedure for synthesis of siloxanes from

Grignard reagents was followed using 4-bromo-1,2-(methylenedioxy)benzene (1.01 g, 602 μ L, 5.00 mmol), magnesium turnings (134 mg, 5.50 mmol), and tetraethyl orthosilicate (3.13 g, 3.35 mL, 15.0 mmol) in THF. Bulb-to-bulb distillation (125 $^{\circ}$ C, 0.5 torr) afforded 1.00 g (74%) of 4-(triethoxysilyl)-1,2-(methylenedioxy)benzene as a colorless oil. IR (CCl_4) 2976 (s), 2926 (m), 2886 (s), 1613 (w), 1503 (w), 1487 (m), 1422 (m), 1237 (m), 1168 (m), 1080 (s), 1045 (m) cm^{-1} ; ^1H (NMR) (CDCl_3) δ 1.24 (t, $J = 6.8$, 9H), 3.85 (q, $J = 6.8$, 6H), 5.95 (s, 2H), 6.86 (d, $J = 7.6$, 1H), 7.12 (s, 1H), 7.19 (d, $J = 7.6$, 1H); ^{13}C (NMR) (CDCl_3) δ 18.1, 59.9, 100.8, 108.8, 114.2, 123.9, 129.6, 147.6, 149.7; MS (m/z) 284 (100), 239 (39), 226 (28), 211 (10), 195 (14), 183 (25), 167 (18), 153 (13), 149 (24), 148 (14), 147 (75), 135 (12); HRMS for $\text{C}_{13}\text{H}_{20}\text{O}_5\text{Si}$ calcd 284.1080, found 284.1083.

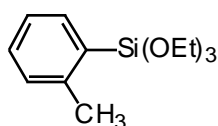

2-(Triethoxysilyl)toluene (Table 3, entry 6). The general procedure for synthesis of siloxanes from Grignard reagents was followed using 2-bromotoluene (855 mg, 601 μ L, 5.00 mmol),

magnesium turnings (134 mg, 5.50 mmol), and tetraethyl orthosilicate (3.13 g, 3.35 mL, 15.0 mmol) in THF. Bulb-to-bulb distillation (125 $^{\circ}$ C, 0.5 torr) afforded 1.03 g (81%) of 2-(triethoxysilyl)toluene as a colorless oil. IR (CCl_4) 3054, 2971, 2922, 2881, 1442, 1393, 1283, 1162, 1079 cm^{-1} ; ^1H NMR (CDCl_3) δ 1.26 (t, $J=7.0$, 9H), 2.26 (s, 3H), 3.87 (q, $J=7.0$, 6H), 7.17 (m, 2H), 7.32 (m, 1H), 7.74 (m, 1H); ^{13}C NMR (CDCl_3) δ 18.2, 22.4, 58.5, 124.7, 129.7, 129.9, 130.5, 136.5, 144.5, MS (m/z) 254 (48), 209 (44), 208 (19), 162 (55), 147 (100), 119 (51), 91 (50), 79 (15); HRMS for $\text{C}_{13}\text{H}_{22}\text{O}_3\text{Si}$ calcd 254.1349, found 254.1338. The IR, ^1H and ^{13}C NMR data were identical to published spectral data.¹²⁰

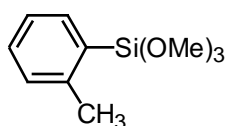

2-(Trimethoxysilyl)toluene (Table 3, entry 7). The general procedure for synthesis of siloxanes from Grignard reagents was

followed using 2-bromotoluene (855 mg, 601 μL , 5.00 mmol), magnesium turnings (134 mg, 5.50 mmol), and tetramethyl orthosilicate (2.28 g, 2.21 mL, 15.0 mmol) in THF. Bulb-to-bulb distillation (125 $^{\circ}\text{C}$, 0.5 torr) afforded 754 mg (71%) of 2-(trimethoxysilyl)toluene as a colorless oil. IR (neat) 3052 (w), 3008 (w), 2942 (s), 2840 (s), 1592 (m), 1471 (m), 1456 (m) cm^{-1} ; ^1H NMR (CDCl_3) δ 2.48 (s, 3H), 3.61 (s, 9H), 7.17 (m, 2H), 7.31 (m, 1H), 7.67 (d, $J=7.5$, 1H); ^{13}C NMR (CDCl_3) δ 22.2, 50.4, 124.7, 128.4, 129.7, 130.6, 136.3, 144.4; MS (m/z) 212 (61), 151 (16), 121 (100), 60 (73); HRMS for $\text{C}_{10}\text{H}_{16}\text{O}_3\text{Si}$ 212.0869, found 212.0859.

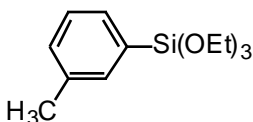

3-(Triethoxysilyl)toluene (Table 3, entry 8). The general procedure for synthesis of siloxanes from Grignard reagents was followed using 3-bromotoluene (855 mg, 607 μL , 5.00 mmol),

magnesium turnings (134 mg, 5.50 mmol), and tetraethyl orthosilicate (3.13 g, 3.35 mL, 15.0 mmol) in THF. Bulb-to-bulb distillation (125 $^{\circ}\text{C}$, 0.5 torr) afforded 954 mg (75%) of 3-(triethoxysilyl)toluene as a colorless oil. IR (neat) 2975 (s), 2926 (s), 2885 (s), 1577 (w), 1480 (w), 1442 (m), 1390 (m), 1295 (w), 1225 (w), 1167 (s), 1104 (vs), 1079 (vs) cm^{-1} ; ^1H (NMR) (CDCl_3) δ 1.25 (t, $J = 7.2$, 9H), 2.36 (s, 3H), 3.87 (q, $J = 7.2$, 6H), 7.23-7.29 (m, 2H), 7.46-7.48 (m, 2H); ^{13}C (NMR) (CDCl_3) δ 18.4, 21.7, 58.9, 128.0, 130.8, 131.4, 132.0, 135.6, 137.4; MS (m/z) 254 (41), 239 (6), 209 (52), 195 (6), 162 (44), 147 (100), 119 (53), 91 (42), 66 (6); HRMS for $\text{C}_{13}\text{H}_{22}\text{O}_3\text{Si}$ calcd 254.1338, found 254.1331.

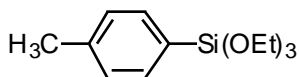

4-(Triethoxysilyl)toluene (Table 3, entry 9). The general procedure for synthesis of siloxanes from Grignard reagents was followed using 4-bromotoluene (855 mg, 638 μL , 5.00

mmol), magnesium turnings (134 mg, 5.50 mmol), and tetraethyl orthosilicate (3.13 g, 3.35 mL, 15.0 mmol) in THF. Bulb-to-bulb distillation (125 $^{\circ}\text{C}$, 0.5 torr) afforded 1.09 g (86%) of 4-(triethoxysilyl)toluene as a colorless oil. IR (CCl_4) 2975 (s), 2926 (m), 2885 (m), 1167(s), 1124 (vs), 1103 (vs), 1080 (vs) cm^{-1} ; ^1H (NMR) (CDCl_3) δ 1.24 (t, $J = 7.0$, 9

H), 2.36 (s, 3 H), 3.86 (q, $J = 7.0, 6$ H), 7.19 (d, $J = 7.9, 2$ H), 7.57 (d, $J = 7.9, 2$ H); ^{13}C (NMR) (CDCl_3) δ 18.2, 21.5, 58.6, 127.4, 128.6, 134.8, 140.2; MS (m/z) 254 (23), 209 (38), 181 (5), 165 (16), 162 (30), 153 (19), 147 (100), 135 (17); HRMS for $\text{C}_{13}\text{H}_{22}\text{O}_3\text{Si}$ calcd 254.1363, found 254.1338. The IR, ^1H and ^{13}C NMR data were identical to published spectral data.²²¹

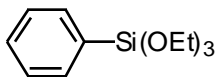

Triethoxyphenylsilane (Table 3, entry 10). The general procedure for synthesis of siloxanes from Grignard reagents was followed using bromobenzene (785 mg, 527 μL , 5.00 mmol), magnesium turnings (134 mg, 5.50 mmol), and tetraethyl orthosilicate (3.13 g, 3.35 mL, 15.0 mmol) in THF. Bulb-to-bulb distillation (125 $^\circ\text{C}$, 0.5 torr) afforded 661 mg (55%) of triethoxyphenylsilane as a colorless oil. Spectral data is reported above. IR (CCl_4) 3140 (w), 2976 (s), 2928 (m), 2941 (m), 1431 (m), 1391 (m), 1129 (s), 1102 (s), 1094 (s), 1080 (s) cm^{-1} ; ^1H (NMR) (CDCl_3) δ 1.25 (t, $J = 7.0, 9$ H), 3.88 (q, $J = 7.0, 6$ H), 7.3-7.5 (m, 3 H), 7.6-7.8 (m, 2 H); ^{13}C (NMR) (CDCl_3) δ 18.1, 58.7, 127.8, 130.2, 131.1, 134.7; MS (m/z) 240 (16), 195 (38), 181 (13), 162 (28), 147 (100), 139 (33), 135 (33); HRMS for $\text{C}_{12}\text{H}_{20}\text{O}_3\text{Si}$ calcd 240.1182, found 240.1141. The IR, ^1H and ^{13}C NMR data were identical to published spectral data.²²¹

General Procedure for the Optimization of the Synthesis of 4-

(Triethoxysilyl)toluene (97) Using 4-Lithioanisole (96) (Table 4) A solution of $n\text{-BuLi}$ (1.5 M in pentane, 3.33 mL, 5.00 mmol) was added dropwise (1 drop per second) to a stirring solution of 4-bromotoluene (**97**) (855 mg, 615 μL , 5.00 mmol) in Et_2O (15.0 mL) at room temperature. After 1 h, the solution was cooled to -78 $^\circ\text{C}$ and added via cannula to a stirring solution of tetraethyl orthosilicate (1.5-3.0 equiv) and the internal standard biphenyl (77 mg, 0.50 mmol) in Et_2O (15.0 mL) at -78 $^\circ\text{C}$. Progress was monitored by GC analysis of aliquots of the quenched reaction mixture. GC response factors relative to the internal naphthalene standard were determined, and the observed percentages of products were normalized accordingly. The reduced product toluene was identified by

comparison of the GC retention time to that of an authentic sample. Polyarylated products were identified by GCMS.

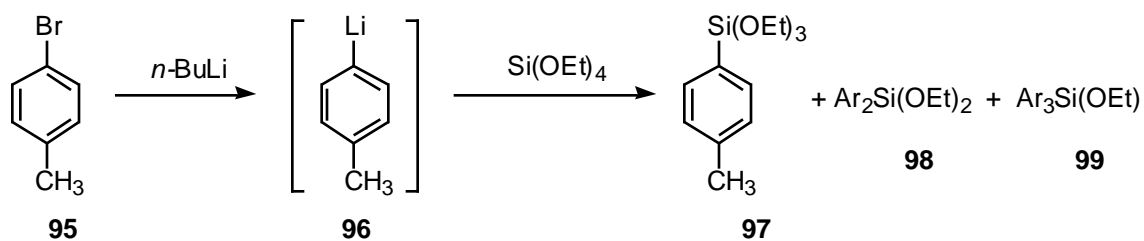

Entry	Conditions ^a			Yield (%) ^{b,c}		
	Equiv Si(OEt) ₄	Solvent	T (°C)	97	98	99
1	1.5	THF	0	7	25	54
2	1.5	THF	-30	74	12	1
3	1.5	Et ₂ O	-30	77	6	0
4	1.5	THF	-78	81	9	0
5	1.5	Et ₂ O	-78	82	5	1
6	3.0	Et ₂ O	-78	86	3	1

^a Reactions of *p*-tolyl lithium **96** (1.0 equiv) with Si(OEt)₄ (1.5 to 3.0 equiv) were allowed to stir at the given temperature; the reaction was complete in 1 h. ^b GC yields are based on amount of 4-bromotoluene (**95**). ^c The remainder of the product was toluene.

Table 4. Optimization of the Synthesis of Arylsiloxanes Using 4-Lithiotoluene.

General Procedure for Synthesis of Siloxanes from Lithium Reagents Using

***n*-BuLi (Table 5).** Unless otherwise indicated, all reactions were performed on a 5 mmol scale. A solution of *n*-BuLi (1.6 M in pentane, 3.1 mL, 5.0 mmol) was added dropwise (1 drop per second) to a stirring solution of the aryl halide (5.00 mmol) in Et₂O or THF (7.0 mL) at room temperature. After 1 h, the solution was cooled to -78 °C and added via cannula to a stirring solution of tetraethyl orthosilicate (1.56 g, 1.68 mL, 7.50 mmol) in Et₂O or THF (7.0 mL) at -78 °C. After 1 h, the reaction was quenched with H₂O (5 drops) at -78 °C and allowed to slowly warm to room temperature. The crude reaction mixture was then extracted with 3 x 50 mL Et₂O. The combined organic extracts were dried over MgSO₄, filtered, and concentrated *in vacuo*. The residue was purified by either column chromatography or by bulb-to-bulb distillation.

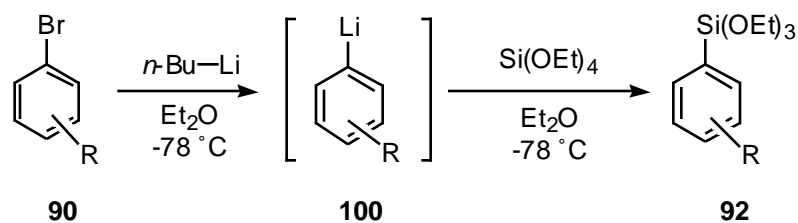

Entry	Aryl Siloxane (92)	% Yield ^{a,b}	Entry	Aryl Siloxane (92)	% Yield ^{a,b}
1		79	7		67
2		71	8		50
3		85	9		30 ^c
4		74	10		50
5		60	11		22 ^d
6		66	12		0

^a Reactions of aryl lithium **100** (1.0 equiv) with Si(OEt)₄ (1.5 equiv) were allowed to stir at -78 °C for 1 h in Et₂O. ^b Yields of **92** are after distillation or chromatography (purity >95%). ^c The major product was Ar₂Si(OEt)₂. ^d G.C. analysis indicated a 2:1:1 ratio of mono:di:tri arylalkoxysilanes.

Table 5. Synthesis of Aryl(trialkoxy)silanes Using Lithium Reagents.

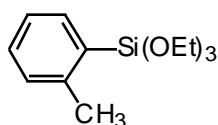

2-(Triethoxysilyl)toluene (Table 5, entry 1). The general procedure for synthesis of siloxanes from lithium reagents was followed using *n*-BuLi (1.6 M in pentane, 3.1 mL, 5.0 mmol),

2-bromotoluene (855 mg, 601 μL , 5.00 mmol), and tetraethyl orthosilicate (1.56 g, 1.68 mL, 7.50 mmol) in Et_2O . Bulb-to-bulb distillation (125 $^\circ\text{C}$, 0.5 torr) afforded 1.00 g (79%) of 2-(triethoxysilyl)toluene as a colorless oil. Spectral data is reported above.

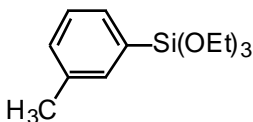

3-(Triethoxysilyl)toluene (Table 5, entry 2). The general procedure for synthesis of siloxanes from lithium reagents was followed using *n*-BuLi (1.6 M in pentane, 3.1 mL, 5.0 mmol),

3-bromotoluene (855 mg, 607 μL , 5.00 mmol), and tetraethyl orthosilicate (1.56 g, 1.68 mL, 7.50 mmol) in Et_2O . Bulb-to-bulb distillation (125 $^\circ\text{C}$, 0.5 torr) afforded 903 mg (71%) of 3-(triethoxysilyl)toluene as a colorless oil. Spectral data is reported above.

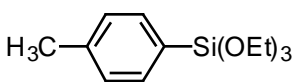

4-(Triethoxysilyl)toluene (Table 5, entry 3). The general procedure for synthesis of siloxanes from lithium reagents was

followed using *n*-BuLi (1.6 M in pentane, 3.1 mL, 5.0 mmol), 4-bromotoluene (855 mg, 638 μL , 5.00 mmol), and tetraethyl orthosilicate (1.56 g, 1.68 mL, 7.50 mmol) in Et_2O . Bulb-to-bulb distillation (125 $^\circ\text{C}$, 0.5 torr) afforded 1.08 g (81%) of 4-(triethoxysilyl)toluene as a colorless oil. Spectral data is reported above.

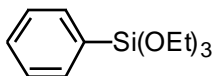

Triethoxyphenylsilane (Table 5, entry 4). The general procedure for synthesis of siloxanes from lithium reagents was followed using

n-BuLi (1.6 M in pentane, 3.1 mL, 5.0 mmol), bromobenzene (785 mg, 527 μL , 5.00 mmol), and tetraethyl orthosilicate (1.56 g, 1.68 mL, 7.50 mmol) in Et_2O . Bulb-to-bulb distillation (125 $^\circ\text{C}$, 0.5 torr) afforded 889 mg (74%) of triethoxyphenylsilane as a colorless oil. Spectral data is reported above.

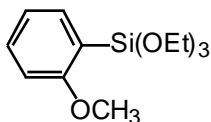

2-(Triethoxysilyl)anisole (Table 5, entry 5). The general procedure for synthesis of siloxanes from lithium reagents was followed using *n*-BuLi (1.6 M in pentane, 3.1 mL, 5.0 mmol),

2-bromoanisole (935 mg, 623 μL , 5.00 mmol), and tetraethyl orthosilicate (1.56 g, 1.68 mL, 7.50 mmol) in Et_2O . Bulb-to-bulb distillation (125 $^\circ\text{C}$, 0.5 torr) afforded 811 mg (60%) of 2-(triethoxysilyl)anisole as a colorless oil. Spectral data is reported above.

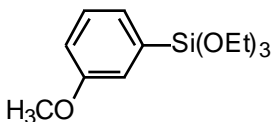

3-(Triethoxysilyl)anisole (Table 5, entry 6). The general procedure for synthesis of siloxanes from lithium reagents was followed using *n*-BuLi (1.6 M in pentane, 3.1 mL, 5.0 mmol),

3-bromoanisole (935 mg, 633 μL , 5.00 mmol), and tetraethyl orthosilicate (1.56 g, 1.68 mL, 7.50 mmol) in Et_2O . Bulb-to-bulb distillation (125 $^\circ\text{C}$, 0.5 torr) afforded 892 mg (66%) of 3-(triethoxysilyl)anisole as a colorless oil. Spectral data is reported above.

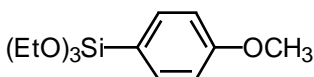

4-(Triethoxysilyl)anisole (Table 5, entry 7). The general procedure for synthesis of siloxanes from lithium reagents was followed using *n*-BuLi (1.6 M in pentane, 3.1 mL, 5.0 mmol),

4-bromoanisole (935 mg, 626 μL , 5.00 mmol), and tetraethyl orthosilicate (1.56 g, 1.68 mL, 7.50 mmol) in Et_2O . Bulb-to-bulb distillation (125 $^\circ\text{C}$, 0.5 torr) afforded 906 mg (67%) of 4-(triethoxysilyl)anisole as a colorless oil. Spectral data is reported above.

4-(Triethoxysilyl)thioanisole (Table 5, entry 8). The following experiment was performed by Correia.²²⁸ The general procedure for synthesis of siloxanes from lithium reagents was

followed using *n*-BuLi (1.6 M in pentane, 6.1 mL, 9.8 mmol), 4-bromothioanisole (1.99 g, 9.80 mmol), and tetraethyl orthosilicate (6.13 g, 6.56 mL, 29.4 mmol) in Et_2O (20 mL). Extraction and flash chromatography (30 mm, 15 cm, 33% CH_2Cl_2 /hexanes) afforded 1.40 g (50%) of 4-(triethoxysilyl)thioanisole as a colorless oil. TLC R_f = 0.25 (33% CH_2Cl_2 /hexanes); IR (CCl_4) 2976 (m), 2925 (m), 1585 (m), 1487 (m), 1440 (m), 1103 (s), 1080 (s) cm^{-1} ; ^1H NMR (CDCl_3) δ 1.24 (t, J = 6.8, 9H), 2.48 (s, 3H), 3.86 (q, J = 6.8, 6H), 7.25 (d, J = 7.9, 2H), 7.58 (d, J = 7.9, 2H); ^{13}C NMR (CDCl_3) δ 15.0, 18.2, 58.7, 125.3,

126.7, 135.1, 141.4; MS (m/z) 287 ($M^+ + 1$, 22), 286 (100), 241 (19), 227 (17), 195 (19), 147 (49), 124 (17), 119 (17); HRMS for $C_{13}H_{22}O_3SSi$ calcd 286.1059, found 286.1063.

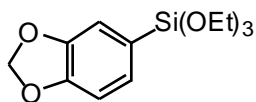

4-(Triethoxysilyl)-1,2-(methylenedioxy)benzene (Table 5, entry 9).

The general procedure for synthesis of siloxanes from lithium reagents was followed using *n*-BuLi (1.6 M in pentane, 3.1 mL, 5.0 mmol), 4-bromo-1,2-(methylenedioxy)benzene (1.01 g, 602 μ L, 5.00 mmol), and tetraethyl orthosilicate (1.56 g, 1.68 mL, 7.50 mmol) in Et₂O. Bulb-to-bulb distillation (125 °C, 0.5 torr) afforded 427 mg (30%) of 4-(triethoxysilyl)-1,2-(methylenedioxy)benzene as a colorless oil. Spectral data is reported above.

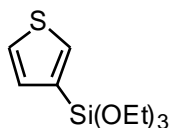

3-(Triethoxysilyl)thiophene (Table 5, entry 10).

The following experiment was performed by Correia.²²⁸ The general procedure for synthesis of siloxanes from lithium reagents was followed using *n*-BuLi (1.6 M in pentane, 7.50 mL, 12.0 mmol), 3-bromothiophene (1.96 g, 1.12 mL, 12.0 mmol), and tetraethyl orthosilicate (7.50 g, 8.05 mL, 36.0 mmol) in Et₂O (20 mL). Extraction and flash chromatography (30 mm, 15 cm, 17% CH₂Cl₂/hexanes) gave 1.48 g (50%) of 3-(triethoxysilyl)thiophene as a colorless oil. TLC R_f = 0.25 (17% CH₂Cl₂/hexanes); IR (CCl₄) 2975 (m), 2926 (m), 1553 (m), 1542 (m), 1103 (s), 1081 (s) cm⁻¹; ¹H NMR (CDCl₃) δ 1.24 (t, J = 7.2, 9H), 3.87 (q, J = 7.2, 6H), 7.29 (d, J = 4.8, 1H), 7.40 (dd, J = 4.8, 2.0, 1H), 7.74 (d, J = 2.0, 1H); ¹³C NMR (CDCl₃) δ 18.2, 58.7, 125.7, 131.7, 131.8, 135.5; MS (m/z) 247 ($M^+ + 1$, 17), 246 (100), 202 (30), 201 (46), 158 (51), 145 (30), 135 (73); HRMS for $C_{10}H_{18}O_3SSi$ calcd 246.0746, found 246.0743.

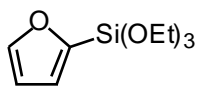

2-furyltriethoxysilane (Table 5, entry 11).

The following experiment was performed by Ahn.²²⁸ A solution of *t*-BuLi (1.50 M in pentane, 16.00 mL, 24.00 mmol) was added dropwise (1 drop per second) to a

stirring solution of the furan (1.36 g, 1.46 mL, 20.0 mmol) and TMEDA (2.32 g, 3.02 mL, 20.0 mmol) in Et₂O (40.0 mL) at 0 °C. After 2 h, the solution was cooled to –78 °C and tetraethyl orthosilicate (6.25 g, 6.69 mL, 30.0 mmol) was added dropwise (1 drop per second). After 1 h, the reaction was quenched with H₂O (1 mL) at –78 °C and allowed to slowly warm to room temperature. The crude reaction mixture was then extracted with 2 x 200 mL Et₂O. The combined organic extracts were dried over MgSO₄, filtered, and concentrated *in vacuo*. Purification of the residue by flash chromatography (30 mm, 15 cm, 10% EtOAc/hexanes) gave 1.01 g (22%) of 2-furyltriethoxysilane as a colorless oil. TLC R_f = 0.71 (10% EtOAc/hexane); IR (CCl₄) 2974 (s), 2926 (s), 2891 (s), 1455 (m), 1390 (m), 1169 (s), 1100 (s), 1079 (s), 965 (m); ¹H (NMR) (CDCl₃) δ 1.23 (t, *J* = 7.0, 9H), 3.87 (q, *J* = 7.0, 6H), 6.39 (dd, *J* = 1.3, 3.3, 1H), 6.87 (d, *J* = 3.3, 1H), 7.65 (d, *J* = 1.3, 1H); ¹³C (NMR) (CDCl₃) δ 18.1, 59.0, 109.3, 123.2, 147.4, 151.3; MS (*m/z*) 231 (M⁺+1, 5), 230 (M⁺, 28), 215 (100), 203 (14), 185 (28), 147 (80), 119 (52), 113 (55), 79 (47), 63 (27); HRMS for C₁₀H₁₈O₄Si calcd 230.0979, found 230.0974.

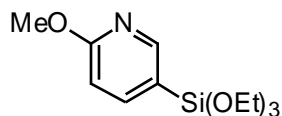

5-Triethoxysilyl-2-methoxypyridine (102). The following experiment was performed by Handy.¹¹¹ The general procedure for synthesis of siloxanes from lithium reagents was followed using *n*-BuLi (1.4 M in pentane, 6.5 mL, 8.8 mmol), 5-bromo-2-methoxypyridine (**101**) (1.66 g, 1.14 mL, 8.83 mmol), and tetraethyl orthosilicate (2.76 g, 2.95 mL, 13.3 mmol) in Et₂O (20 mL). Extraction and flash chromatography (9:1 hexanes/EtOAc) afforded 527 mg (22%) of **102** as a colorless oil. TLC R_f = 0.28 (9:1 hexanes/EtOAc); IR (CCl₄) 2976 (s), 2927 (m), 2887 (m), 1589 (s), 1491 (w), 1442 (m), 1390 (w), 1356 (m), 1286 (s), 1082 (vs) cm⁻¹; ¹H (NMR) (CD₃CN) δ 1.20 (t, *J* = 7.0, 9H), 3.83 (q, *J* = 7.0, 6H), 3.87 (s, 3H), 6.73-6.75 (m, 1H), 7.76-7.78 (m, 1H), 8.32-8.35 (m, 1H); ¹³C (NMR) (CD₃CN) δ 18.6, 53.9, 59.5, 111.5, 130.8, 118.2, 145.5, 154.3, 166.5; MS (*m/z*) 272 (100), 240 (13), 226 (31), 170 (11), 163 (11), 136 (15), 119 (6), 91 (5), 79 (14); HRMS for C₁₂H₂₂ONSi calcd 272.1318, found 272.1311.

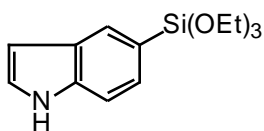

5-(Triethoxysilyl)indole (110). The following experiment was performed by Handy.¹¹¹ To a solution of KH (35% dispersion in mineral oil, 292 mg, 2.55 mmol) in THF (5.0 mL) was added dropwise (1 drop per second) a solution of 5-bromoindole (498 mg, 2.54 mmol) in THF (5.0 mL). The reaction mixture was stirred for 15 min then cooled to $-78\text{ }^{\circ}\text{C}$. A solution of *t*-BuLi (1.7 M in pentane, 3.0 mL, 5.0 mmol) was then added *via* cannula. A white precipitate immediately formed. The mixture was stirred for 10 min, followed by dropwise (1 drop per second) addition of a solution of tetraethyl orthosilicate (1.06 g, 1.13 mL, 5.08 mmol) in THF (2 mL). The reaction mixture was stirred for 30 min at $-78\text{ }^{\circ}\text{C}$, and then allowed to slowly warm to room temperature. The reaction mixture was poured into 10 mL ice water, then extracted with ether ($3 \times 15\text{ mL}$). The combined organic extracts were dried over MgSO_4 , then concentrated *in vacuo*. Column chromatography (4:1 hexanes/EtOAc) afforded 497 mg (70%) of **110** as a pale yellow oil; TLC $R_f = 0.32$ (4:1 hexanes/EtOAc); IR (CCl_4) 3489 (s), 2976 (s), 2926 (m), 1885 (m) cm^{-1} ; ^1H NMR (CDCl_3) δ 8.38 (br s, 1H), 8.03 (s, 1H), 7.48 (d, $J=8.1\text{ Hz}$, 1H), 7.39 (d, $J=8.1\text{ Hz}$, 1H), 7.16 (t, $J=2.6\text{ Hz}$, 1H), 6.56 (s, 1H), 3.89 (q, $J=7.0$, 6H), 1.26 (t, $J=7.0$, 9H); ^{13}C NMR (CDCl_3) δ 137.2, 128.5, 127.7, 127.6, 124.2, 120.0, 110.9, 102.7, 58.6, 18.2; MS (m/z) 280 (70), 234 (42), 206 (14), 190 (21), 163 (100), 144 (78), 117 (58); HRMS for $\text{C}_{14}\text{H}_{21}\text{NO}_3\text{Si}$ calcd 280.1369, found 280.1381.

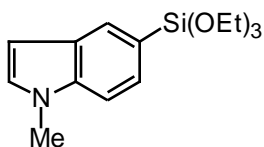

5-(Triethoxysilyl)-1-methylindole (111). The following experiment was performed by Correia.²²⁸ A solution of *t*-BuLi (1.50 M in pentane, 3.76 mL, 5.64 mmol) was added dropwise (1 drop per second) to a stirring solution of 5-bromo-1-methylindole (987 mg, 4.70 mmol) in Et_2O (10.0 mL) at $-78\text{ }^{\circ}\text{C}$. After 15 min, the solution was added dropwise (1 drop per second) *via* cannula to a solution of tetraethyl orthosilicate (6.25 g, 6.69 mL, 30.0 mmol) in 5 mL of Et_2O cooled to $-78\text{ }^{\circ}\text{C}$. After 1 h, the reaction was allowed to slowly warm to room temperature. The reaction mixture was quenched by the addition of 50 mL of water. The

crude reaction mixture was then extracted with 4 x 50 mL Et₂O. The combined organic extracts were dried over Na₂SO₄, filtered, and concentrated *in vacuo*. Purification of the residue by flash chromatography (30 mm, 15 cm, 33% CH₂Cl₂/hexane) gave 840 mg (60%) of **111** as a yellow oil. TLC R_f = 0.37 (33% CH₂Cl₂/hexane); IR (CCl₄) 2975 (s), 2923 (m), 2882 (m), 1611 (m), 1556 (s), 1518 (m), 1480 (m), 1104 (s), 1080 (s) cm⁻¹; ¹H NMR (CDCl₃) δ 1.25 (t, *J* = 7.2, 9H), 3.79 (s, 3H), 3.88 (q, *J* = 7.2, 6H), 6.52 (d, *J* = 2.8, 1H), 7.05 (d, *J* = 2.8, 1H), 7.36 (d, *J* = 7.9, 1H), 7.52 (d, *J* = 7.9, 1H), 8.00 (s, 1H); ¹³C NMR (CDCl₃) δ 18.2, 32.6, 58.5, 101.3, 108.9, 119.4, 127.3, 128.2, 128.6, 128.8, 137.9; MS (*m/z*) 294 (M⁺+1, 29), 293 (M⁺, 100), 278 (10), 131 (23). HRMS for C₁₅H₂₃NO₃Si calcd 293.1447, found 293.1439.

General Procedure for the Optimization of the Silylation of 4-Bromoanisole (86)

(Table 6). All siloxanes were synthesized using modifications of the procedure reported by Masuda.²²¹ 4-Bromoanisole (**86**)(187 mg, 125 μL, 1.00 mmol, 1.0 equiv), and base (3.00 mmol, 3.0 equiv) were added to a stirring solution of Pd(dba)₂ (29 mg, 0.05 mmol, 5 mol %), the phosphine (0.10 mmol, 10 mol%), and the internal standard naphthalene (128 mg, 1.0 mmol, 1.0 equiv) in 4 mL of solvent under an atmosphere of argon.

Triethoxysilane (246 mg, 277 μL, 1.50 mmol, 1.5 equiv) was added, causing bubbling, formation of yellow foam, and darkening of the reaction mixture. The reaction mixture was allowed to stir at room temperature for 12 h. Progress was monitored by GC analysis of aliquots of the quenched reaction mixture. GC response factors relative to the internal naphthalene standard were determined, and the observed percentages of products were normalized accordingly. The reduced product anisole **119** was identified by comparison of the GC retention time to that of an authentic sample.

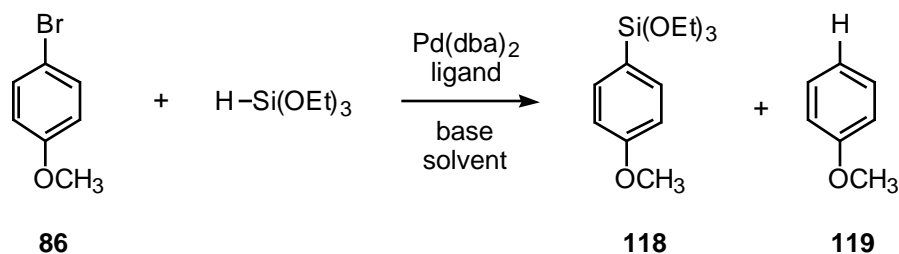

Entry	Conditions ^a			Yield (%) ^{b,c}	
	Ligand (10 mol %)	Base (3 mmol)	Solvent (4 mL)	118	119
1	P(<i>o</i> -tol) ₃	<i>i</i> -Pr ₂ NEt	NMP	21	79
2	P(<i>o</i> -tol) ₃	<i>i</i> -Pr ₂ NEt	DMF	15	70
3	none	<i>i</i> -Pr ₂ NEt	DMF	14	86
4	PPh ₃	<i>i</i> -Pr ₂ NEt	DMF	0	5
5	dppf	<i>i</i> -Pr ₂ NEt	NMP	0	8
6	P(<i>t</i> -Bu) ₃	<i>i</i> -Pr ₂ NEt	NMP	59	41
7	P(<i>t</i> -Bu) ₃	<i>i</i> -Pr ₂ NEt	DMF	45	55
8	P[(2,4,6-OMe)Ph] ₃	<i>i</i> -Pr ₂ NEt	NMP	8	92
9	P(cy) ₂ (<i>o</i> -biphenyl)	<i>i</i> -Pr ₂ NEt	NMP	17	83
10	P(<i>t</i> -Bu) ₂ (<i>o</i> -biphenyl)	<i>i</i> -Pr ₂ NEt	NMP	75	25
11	P(<i>t</i> -Bu) ₂ (<i>o</i> -biphenyl)	<i>i</i> -Pr ₂ NEt	DMF	36	64
12	P(<i>t</i> -Bu) ₂ (<i>o</i> -biphenyl)	<i>i</i> -Pr ₂ NEt	THF	6	54
13	P(<i>t</i> -Bu) ₂ (<i>o</i> -biphenyl)	<i>i</i> -Pr ₂ NEt	CH ₃ CN	6	93
14	P(<i>t</i> -Bu) ₂ (<i>o</i> -biphenyl)	<i>i</i> -Pr ₂ NEt	toluene	3	19
15	P(<i>t</i> -Bu) ₂ (<i>o</i> -biphenyl)	none	NMP	0	4
16	P(<i>t</i> -Bu) ₂ (<i>o</i> -biphenyl)	Et ₃ N	NMP	55	45
17	P(<i>t</i> -Bu) ₂ (<i>o</i> -biphenyl)	pyridine	NMP	0	5
18	P(<i>t</i> -Bu) ₂ (<i>o</i> -biphenyl)	2,6-lutidine	NMP	32	26
19	P(<i>t</i> -Bu) ₂ (<i>o</i> -biphenyl)	DBU	NMP	0	57
20	P(<i>t</i> -Bu) ₂ (<i>o</i> -biphenyl)	KOAc	NMP	22	78
21	P(<i>t</i> -Bu) ₂ (<i>o</i> -biphenyl)	Cs ₂ CO ₃	NMP	3	97

^a Reactions of 4-bromoanisole (**86**) (1.0 equiv) with H-Si(OEt)₃ (1.5 equiv) were allowed to stir at room temperature for 12 h in 4 mL of solvent by using Pd(dba)₂ (5 mol %), phosphine (10 mol %), and base (3.0 equiv). ^b GC yields are based on amount of 4-bromoanisole. ^c Remaining percentage was unreacted starting material.

Table 6. Optimization of the Silylation of 4-Bromoanisole.

General Procedure for the Silylation of Aryl Halides (Tables 7-10) All siloxanes were synthesized using a modification of the procedure reported by Masuda.²²¹ The indicated aryl halide (5.00 mmol, 1.0 equiv), and *i*-Pr₂NEt (1.94 g, 2.61 mL, 15.0 mmol, 3.0 equiv) were added to a stirring solution of Pd(dba)₂ (86 mg, 0.15 mmol, 3 mol %), and

P(*t*-Bu)₂(*o*-biphenyl) (**120**) (90 mg, 0.30 mmol, 6 mol%) in 20 mL of NMP under an atmosphere of argon. Triethoxysilane (1.23 g, 1.38 mL, 7.50 mmol, 1.5 equiv) was added, causing bubbling, formation of yellow foam, and darkening of the reaction mixture. Unless otherwise noted, the reaction was performed at the given temperature until GC analysis indicated that the starting material had been consumed. The reaction mixture was extracted with 5 x 100 mL pentane, without the addition of water or aqueous solutions, which led to intractable emulsions and potential polymerization; note that NMP and pentane are immiscible. The combined pentane extracts were washed with 3 x 100 mL water to remove NMP, dried over MgSO₄, filtered, and concentrated *in vacuo*. Purification of the residue by bulb-to-bulb distillation yielded the siloxane.

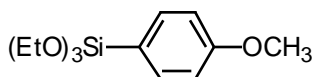

4-(Triethoxysilyl)anisole (Table 7, entry 1). The general procedure for silylation was followed using 4-bromoanisole (935 mg, 626 μ L, 5.00 mmol), *i*-Pr₂NEt (1.94 g, 2.61 mL, 15.0 mmol), Pd(dba)₂ (86 mg, 0.15 mmol), P(*t*-Bu)₂(*o*-biphenyl) (**120**) (90 mg, 0.30 mmol), and triethoxysilane (1.23 g, 1.38 mL, 7.50 mmol) in 20 mL of NMP. The reaction was heated at 60 °C for 12h. Bulb-to-bulb distillation (125 °C, 0.5 torr) afforded 919 mg (68 %) of 4-(triethoxysilyl)anisole as a colorless oil. Spectral data is reported above.

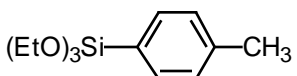

4-(Triethoxysilyl)toluene (Table 7, entry 2). The general procedure for silylation was followed using 4-bromotoluene (855 mg, 638 μ L, 5.00 mmol), *i*-Pr₂NEt (1.94 g, 2.61 mL, 15.0 mmol), Pd(dba)₂ (86 mg, 0.15 mmol), P(*t*-Bu)₂(*o*-biphenyl) (**120**) (90 mg, 0.30 mmol), and triethoxysilane (1.23 g, 1.38 mL, 7.50 mmol) in 20 mL of NMP. The reaction was heated at 60 °C for 12 h. Bulb-to-bulb distillation (125 °C, 0.5 torr) afforded 547 mg (43%) of 4-(triethoxysilyl)toluene as a colorless oil. Spectral data is reported above.

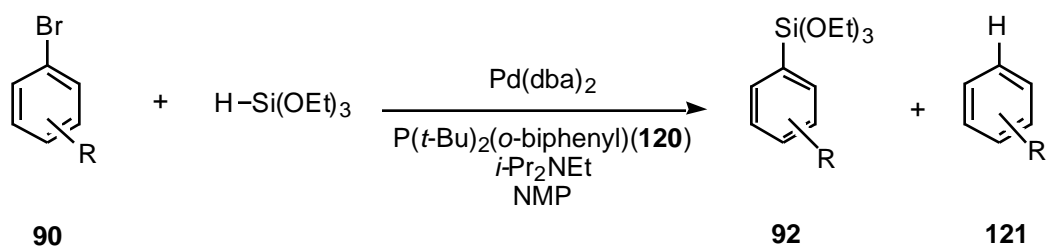

Entry	Aryl Bromide (90)	% Yield ^{a-c} (92)	Entry	Aryl Bromide (90)	% Yield ^{a-c} (92)
1		68	6		30
2		43	7		28 ^{d,e}
3		44	8		5
4		33	9		0
5		38 ^{d,e}	10		0

^a Reactions of arylbromide (**90**) (1.0 equiv) with H-Si(OEt)₃ (1.5 equiv) were allowed to stir at 60 °C for 12 h in NMP by using 3 mol % Pd(dba)₂, (t-Bu)₂P(o-biphenyl)(**120**) (6 mol %), and i-Pr₂NEt (3 equiv). ^b Isolated yield of purified (>95%) product. ^c Unless otherwise indicated, remaining percentage was reduced starting material (**121**). ^d Reaction allowed to stir at room temperature. ^e Reaction stopped at 2 h.

Table 7. Silylation of Aryl Bromides.

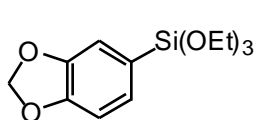

4-(Triethoxysilyl)-1,2-(methylenedioxy)benzene (Table 7, entry 3). The general procedure for silylation was followed using

4-(triethoxysilyl)-1,2-(methylenedioxy)benzene (1.01 g, 602 μL,

5.00 mmol), i-Pr₂NEt (1.94 g, 2.61 mL, 15.0 mmol), Pd(dba)₂ (86 mg, 0.15 mmol),

P(t-Bu)₂(o-biphenyl) (**120**) (90 mg, 0.30 mmol), and triethoxysilane (1.23 g, 1.38 mL, 7.50

mmol) in 20 mL of NMP. The reaction was heated at 60 °C for 12 h. Bulb-to-bulb

distillation (125 °C, 0.5 torr) afforded 626 mg (44%) of

4-(triethoxysilyl)-1,2-(methylenedioxy)benzene as a colorless oil. Spectral data is reported above.

4-(Triethoxysilyl)acetanilide (Table 7, entry 4). The general procedure for silylation was followed using 4-bromoacetanilide (1.07 g, 5.00 mmol), *i*-Pr₂NEt (1.94 g, 2.61 mL, 15.0 mmol), Pd(dba)₂ (86 mg, 0.15 mmol), P(*t*-Bu)₂(*o*-biphenyl) (**120**) (90 mg, 0.30 mmol), and triethoxysilane (1.23 g, 1.38 mL, 7.50 mmol) in 20 mL of NMP. The reaction was heated at 60 °C for 12 h. Bulb-to-bulb distillation (125 °C, 0.5 torr) afforded 491 mg (33%) 4-(triethoxysilyl)acetanilide as a colorless oil. IR (neat) 3307 (br), 2975 (s), 1670 (s), 1593 (s), 1524 (s), 1392 (s), 1318 (s), 1291 (s), 1166 (s), 1072 (vs) cm⁻¹; ¹H (NMR) (CDCl₃) δ 1.24 (t, *J* = 6.8, 9 H), 2.18 (s, 3 H), 3.85 (q, *J* = 6.8, 6 H), 7.52 (d, *J* = 8.3, 2 H), 7.64 (d, *J* = 8.3, 2 H); ¹³C (NMR) (CDCl₃) δ 18.2, 24.5, 58.7, 119.1, 128.6, 135.7, 140.1, 169.0; MS (*m/z*) 297 (10), 252 (68), 205 (100), 176 (31), 162 (15), 147 (48); HRMS for C₁₄H₂₃O₄NSi calcd 297.1396, found 297.1399. The IR, ¹H and ¹³C NMR data were identical to published spectral data.²²¹

4-(Triethoxysilyl)aniline (Table 7, entry 5). The general procedure for silylation was followed using 4-bromoaniline (860 mg, 573 μL, 5.00 mmol), *i*-Pr₂NEt (1.94 g, 2.61 mL, 15.0 mmol), Pd(dba)₂ (86 mg, 0.15 mmol), P(*t*-Bu)₂(*o*-biphenyl) (**120**) (90 mg, 0.30 mmol), and triethoxysilane (1.23 g, 1.38 mL, 7.50 mmol) in 20 mL of NMP. The reaction was stirred at 25 °C for 2 h. Bulb-to-bulb distillation (125 °C, 0.5 torr) afforded 485 mg (38%) of 4-(triethoxysilyl)aniline as a colorless oil. IR (neat) 3469 (m), 3372 (s), 3223 (w), 2974 (s), 2926 (s), 2885 (s), 1624 (s), 1601 (s), 1509 (m), 1390 (m), 1295 (m), 1166 (s), 1074 (vs) cm⁻¹; ¹H (NMR) (CDCl₃) δ 1.23 (t, *J* = 7.0, 9H), 3.79 (s, 2H), 3.84 (q, *J* = 7.0, 6H), 6.67 (d, *J* = 8.3, 2H), 7.46 (d, *J* = 8.3, 2H); ¹³C (NMR) (CDCl₃) δ 18.3, 28.6, 114.4, 118.4,

136.3, 148.6; MS (m/z) 255 (100), 210 (48), 153 (11), 147 (34), 136 (9), 135 (3); HRMS for $C_{12}H_{21}O_3NSi$ calcd 255.1291, found 255.1292.

4-Acetoxy(triethoxysilyl)benzene (Table 7, entry 6). The general procedure for silylation was followed using 4-acetoxybromobenzene (1.01 g, 5.00 mmol), iPr_2NEt (1.94 g, 2.61 mL, 15.0 mmol), $Pd(dba)_2$ (86 mg, 0.15 mmol), $P(t-Bu)_2(o-biphenyl)$ (**120**) (90 mg, 0.30 mmol), and triethoxysilane (1.23 g, 1.38 mL, 7.50 mmol) in 20 mL of NMP. The reaction was heated at 60 °C for 12 h. Bulb-to-bulb distillation (125 °C, 0.5 torr) afforded 448 mg (30%) of 4-acetoxy(triethoxysilyl)benzene as a colorless oil following purification. IR (neat) 2976 (s), 2887 (s), 1767 (s), 1593 (m), 1499 (w), 1392 (m) cm^{-1} ; 1H (NMR) ($CDCl_3$) δ 1.22 (t, $J = 6.8$, 9 H), 2.28 (s, 3 H), 3.84 (q, $J = 6.8$, 6 H), 7.09 (d, $J = 8.3$, 2 H), 7.67 (d, $J = 8.3$, 2 H); ^{13}C (NMR) ($CDCl_3$) δ 18.1, 21.0, 58.7, 121.0, 128.6, 136.1, 152.5, 169.0; MS (m/z) 298 (3), 256 (100), 210 (51), 183 (17), 155 (27), 147 (62); HRMS for $C_{14}H_{22}O_5Si$ calcd 298.1237, found 298.1238. The IR, 1H and ^{13}C NMR data were identical to published spectral data.²²¹

4-(Triethoxysilyl)phenol (Table 7, entry 7). The general procedure for silylation was followed using 4-bromophenol (865 mg, 5.00 mmol), iPr_2NEt (1.94 g, 2.61 mL, 15.0 mmol), $Pd(dba)_2$ (86 mg, 0.15 mmol), $P(t-Bu)_2(o-biphenyl)$ (**120**) (90 mg, 0.30 mmol), and triethoxysilane (1.23 g, 1.38 mL, 7.50 mmol) in 20 mL of NMP. The reaction was stirred at 25 °C for 2 h. Bulb-to-bulb distillation (125 °C, 0.5 torr) afforded 359 mg (28%) of 4-(triethoxysilyl)phenol as a colorless oil following purification. IR (CCl_4) 3606 (s), 3356 (vs), 2976 (s), 2926 (s), 2885 (s), 1602 (m), 1582 (w), 1506 (m), 1390 (w), 1261 (w), 1167 (m), 1125 (s), 1107 (s), 1080 (s) cm^{-1} ; 1H (NMR) ($CDCl_3$) δ 1.24 (t, $J = 7.2$, 9H), 3.87 (q, $J = 7.2$, 6H), 6.23 (s, 1H), 6.85 (d, $J = 8.3$, 2H), 7.55 (d, $J = 8.3$, 2H); ^{13}C (NMR) ($CDCl_3$) δ 18.3, 59.0, 115.4, 121.2, 137.0, 158.1; MS (m/z) 256 (100), 241 (13), 220 (12),

211 (43), 210 (40), 183 (13), 167 (11), 163 (17), 155 (14), 147 (55), 119 (18); HRMS for $C_{12}H_{20}O_4Si$ calcd 256.1131, found 256.1135.

Triethoxyphenylsilane (Table 7, entry 8). The general procedure for silylation was followed using bromobenzene (785 mg, 527 μ L, 5.00 mmol), *i*-Pr₂NEt (1.94 g, 2.61 mL, 15.0 mmol), Pd(dba)₂ (86 mg, 0.15 mmol), P(*t*-Bu)₂(*o*-biphenyl) (**120**) (90 mg, 0.30 mmol), and triethoxysilane (1.23 g, 1.38 mL, 7.50 mmol) in 20 mL of NMP. The reaction was heated at 60 °C for 12 h. Bulb-to-bulb distillation (125 °C, 0.5 torr) afforded 60 mg (5%) of triethoxyphenylsilane as a colorless oil following purification. Spectral data is reported above.

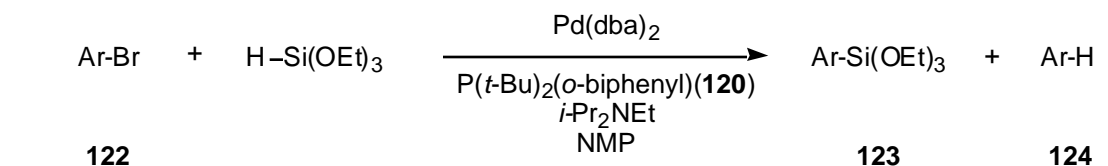

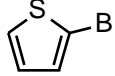
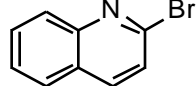
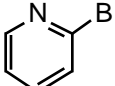
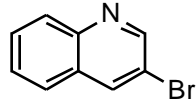
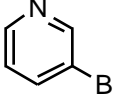
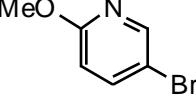
Entry	Heteroaryl Bromide (122)	% Yield ^{a-c} (123)	Entry	Heteroaryl Bromide (122)	% Yield ^{a-c} (123)
1		43	4		0
2		0 ^d	5		0
3		0	6		57

^a Reactions of heteroaryl bromide (**122**) (1.0 equiv) with H-Si(OEt)₃ (1.5 equiv) were allowed to stir at 60 °C for 12 h in NMP by using 3 mol % Pd(dba)₂, (*t*-Bu)₂P(*o*-biphenyl)(**120**) (6 mol %), and *i*-Pr₂NEt (3 equiv). ^b Isolated yield of purified (>95%) product. ^c Unless otherwise noted, the remaining percentage was reduced starting material (**124**). ^d Trace amounts of 2,2'-dipyridyl were observed by G.C. analysis.

Table 8. Silylation of Heteroaryl Bromides.

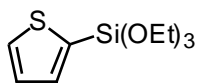

2-(Triethoxysilyl)thiophene (Table 8, entry 1). The general

procedure for silylation was followed using 2-bromothiophene (815 mg, 484 μ L, 5.00 mmol), *i*-Pr₂NEt (1.94 g, 2.61 mL, 15.0 mmol), Pd(dba)₂ (86 mg, 0.15 mmol), P(*t*-Bu)₂(*o*-biphenyl) (**120**) (90 mg, 0.30 mmol), and triethoxysilane (1.23 g, 1.38 mL, 7.50 mmol) in 20 mL of NMP. The reaction was heated at 60 °C for 12 h. Bulb-to-bulb distillation (125 °C, 0.5 torr) afforded 530 mg (43%) of 2-(triethoxysilyl)thiophene as a colorless oil. IR (neat) 2976 (s), 2888 (s), 1695 (w), 1501 (w), 1442 (s), 1407 (s), 1391(m), 1296 (m), 1216 (m), 1167 (s) cm⁻¹; ¹H (NMR) (CDCl₃) δ 1.25 (t, *J* = 7.0, 9 H), 3.90 (q, *J* = 7.0, 6 H), 7.22 (dd, *J* = 3.3, 4.5, 1 H), 7.48 (d, *J* = 3.3, 1 H), 7.66 (d, *J* = 4.5, 1 H); ¹³C (NMR) (CDCl₃) δ 19.4, 60.3, 129.4, 130.6, 133.2, 138.1; MS (*m/z*) 246 (52), 213 (6), 201 (34), 187 (7), 167 (7), 158 (13), 147 (100), 135 (34); HRMS for C₁₀H₁₈O₃SiS calcd 246.0765, found 246.0746. The IR, ¹H and ¹³C NMR data were identical to published spectral data.²²¹

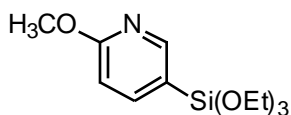

5-(Triethoxysilyl)-2-methoxypyridine (102) (Table 8, entry

6). The general procedure for silylation was followed using 5-bromo-2-methoxypyridine (940 mg, 647 μ L, 5.00 mmol), *i*-Pr₂NEt (1.94 g, 2.61 mL, 15.0 mmol), Pd(dba)₂ (86 mg, 0.15 mmol), P(*t*-Bu)₂(*o*-biphenyl) (**120**) (90 mg, 0.30 mmol), and triethoxysilane (1.23 g, 1.38 mL, 7.50 mmol) in 20 mL of NMP. The reaction was heated at 60 °C for 12 h. Bulb-to-bulb distillation (125 °C, 0.5 torr) afforded 773 mg (57%) of 5-(triethoxysilyl)-2-methoxypyridine as a colorless oil following purification. Spectral data is reported above.

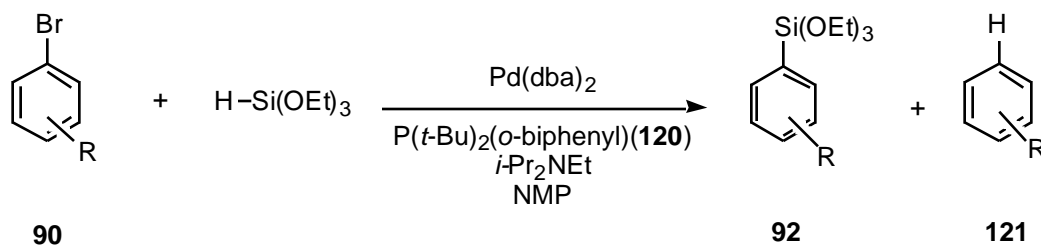

Entry	Aryl Bromide (90)	% Yield (92) ^{a-c}	Entry	Aryl Bromide (90)	% Yield (92) ^{a-c}
1		68	4		43
2		25	5		10
3		0	6		0

^a Reactions of arylbromide (**90**) (1.0 equiv) with H-Si(OEt)₃ (1.5 equiv) were allowed to stir at 60 °C for 12 h in NMP using 3 mol % Pd(dba)₂, P(*t*-Bu)₂(*o*-biphenyl) (**120**) (6 mol %), and *i*-Pr₂NEt (3 equiv). ^b Yields are isolated yields of purified (>95%) product. ^c Remaining yield was of reduced starting material (**121**).

Table 9. Silylation of Aryl Bromides: Effect of Substituent Position.

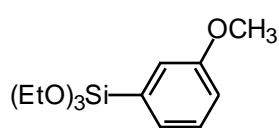

3-(Triethoxysilyl)anisole (Table 9, entry 2). The general procedure for silylation was followed using 3-bromoanisole (935 mg, 633 μL , 5.00 mmol), *i*-Pr₂NEt (1.94 g, 2.61 mL, 15.0 mmol), Pd(dba)₂ (86 mg, 0.15 mmol), P(*t*-Bu)₂(*o*-biphenyl) (**120**) (90 mg, 0.30 mmol), and triethoxysilane (1.23 g, 1.38 mL, 7.50 mmol) in 20 mL of NMP. The reaction was heated at 60 °C for 12 h. Bulb-to-bulb distillation (125 °C, 0.5 torr) afforded 338 mg (25%) of 3-(triethoxysilyl)anisole as a colorless oil. Spectral data is reported above.

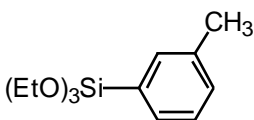

3-(Triethoxysilyl)toluene (Table 3, entry 5). The general procedure for silylation was followed using 3-bromotoluene (855 mg, 607 μL , 5.00 mmol), *i*-Pr₂NEt (1.94 g, 2.61 mL, 15.0 mmol), Pd(dba)₂ (86 mg, 0.15 mmol), P(*t*-Bu)₂(*o*-biphenyl) (**120**) (90 mg, 0.30 mmol), and triethoxysilane

(1.23 g, 1.38 mL, 7.50 mmol) in 20 mL of NMP. The reaction was heated at 60 °C for 12 h. Bulb-to-bulb distillation (125 °C, 0.5 torr) afforded 127 mg (10%) of 3-(triethoxysilyl)toluene as a colorless oil. Spectral data is reported above.

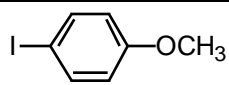
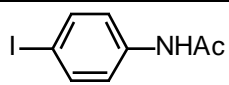
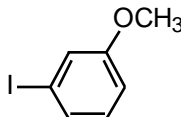
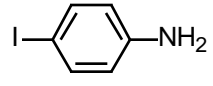
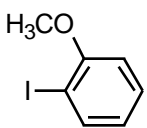
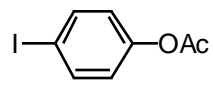
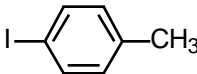
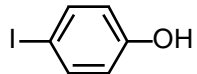
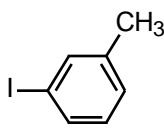
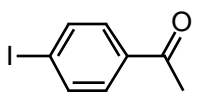
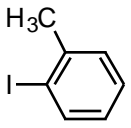
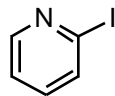
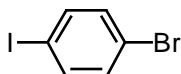
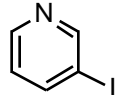
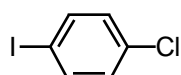
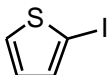
$\text{Ar-I} + \text{H-Si(OEt)}_3 \xrightarrow[\text{NMP}]{\text{Pd(dba)}_2, \text{P}(t\text{-Bu})_2(\text{o-biphenyl})(\mathbf{120}), i\text{-Pr}_2\text{NEt}}$			$\text{Ar-Si(OEt)}_3 + \text{Ar-H}$		
Entry	Aryl Iodide (128)	% Yield (123) ^{a-c}	Entry	Aryl Iodide (128)	% Yield (123) ^{a-c}
1		86	10		68 ^e
2		52	11		77 ^e
3		10	12		75 ^e
4		80	13		70 ^d
6		65	14		24
7		0 ^d	15		0 ^{d,9}
8		68 ^{e,f}	16		10
9		75 ^e	17		92

^a Reactions of aryl iodide (**128**) (1.0 equiv) with H-Si(OEt)₃ (1.5 equiv) were allowed to stir at 60 °C for 12 h in NMP using Pd(dba)₂ (3 mol %), (t-Bu)₂P(o-biphenyl) (**120**) (6 mol %), and *i*-Pr₂NEt (3 equiv). ^b Yields shown in parentheses are GC yields; all other yields are isolated yields of purified (>95%) product. ^c Unless noted otherwise, the remaining percentage was of reduced starting material (**124**). ^d Yield confirmed by GCMS. ^e Reaction allowed to stir at room temperature. ^f Reaction stopped at 2 h. ⁹ Dipyrindyl was isolated in 15% yield.

Table 10. Palladium-Catalyzed Silylation of Aryl Iodides.

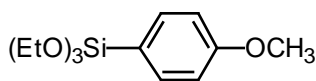

4-(Triethoxysilyl)anisole (Table 10, entry 1). The general procedure for silylation was followed using 4-iodoanisole (1.17 g, 5.00 mmol), *i*-Pr₂NEt (1.94 g, 2.61 mL, 15.0 mmol), Pd(dba)₂ (86 mg, 0.15 mmol), P(*t*-Bu)₂(*o*-biphenyl) (**120**) (90 mg, 0.30 mmol), and triethoxysilane (1.23 g, 1.38 mL, 7.50 mmol) in 20 mL of NMP. The reaction was heated at 60 °C for 12 h. Bulb-to-bulb distillation (125 °C, 0.5 torr) afforded 1.16 g (86%) of 4-(triethoxysilyl)anisole as a colorless oil. Spectral data is reported above.

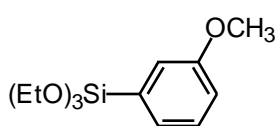

3-(Triethoxysilyl)anisole (Table 10, entry 2). The general procedure for silylation was followed using 3-iodoanisole (1.17 g, 596 μL, 5.00 mmol), *i*-Pr₂NEt (1.94 g, 2.61 mL, 15.0 mmol), Pd(dba)₂ (86 mg, 0.15 mmol), P(*t*-Bu)₂(*o*-biphenyl) (**120**) (90 mg, 0.30 mmol), and triethoxysilane (1.23 g, 1.38 mL, 7.50 mmol) in 20 mL of NMP. The reaction was heated at 60 °C for 12 h. Bulb-to-bulb distillation (125 °C, 0.5 torr) afforded 703 mg (52%) of 3-(triethoxysilyl)anisole as a colorless oil. Spectral data is reported above.

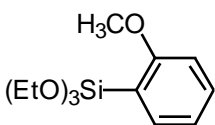

2-(Triethoxysilyl)anisole (Table 10, entry 3). The general procedure for silylation was followed using 2-iodoanisole (1.17 g, 650 μL, 5.00 mmol), *i*-Pr₂NEt (1.94 g, 2.61 mL, 15.0 mmol), Pd(dba)₂ (86 mg, 0.15 mmol), P(*t*-Bu)₂(*o*-biphenyl) (**120**) (90 mg, 0.30 mmol), and triethoxysilane (1.23 g, 1.38 mL, 7.50 mmol) in 20 mL of NMP. The reaction was heated at 60 °C for 12 h. Bulb-to-bulb distillation (125 °C, 0.5 torr) afforded 135 mg (10%) of 2-(triethoxysilyl)anisole as a colorless oil. Spectral data is reported above.

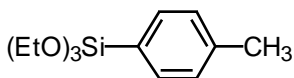

4-(Triethoxysilyl)toluene (Table 10, entry 4). The general procedure for silylation was followed using 4-iodotoluene (1.09 g, 5.00 mmol), *i*-Pr₂NEt (1.94 g, 2.61 mL, 15.0 mmol), Pd(dba)₂ (86 mg, 0.15 mmol), P(*t*-Bu)₂(*o*-biphenyl) (**120**) (90 mg, 0.30 mmol), and triethoxysilane (1.23 g, 1.38 mL, 7.50 mmol) in 20 mL of NMP. The reaction was heated at 60 °C for 12 h.

Bulb-to-bulb distillation (125 °C, 0.5 torr) afforded 1.02 g (80%) of 4-(triethoxysilyl)toluene as a colorless oil. Spectral data is reported above.

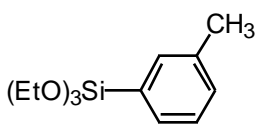

3-(Triethoxysilyl)toluene (Table 10, entry 6). The general procedure for silylation was followed using 3-iodotoluene (1.09 g, 642 μ L, 5.00 mmol), *i*-Pr₂NEt (1.94 g, 2.61 mL, 15.0 mmol), Pd(dba)₂ (86 mg, 0.15 mmol), P(*t*-Bu)₂(*o*-biphenyl) (**120**) (90 mg, 0.30 mmol), and triethoxysilane (1.23 g, 1.38 mL, 7.50 mmol) in 20 mL of NMP. The reaction was heated at 60 °C for 12 h. Bulb-to-bulb distillation (125 °C, 0.5 torr) afforded 827 mg (65%) of 3-(triethoxysilyl)toluene as a colorless oil. Spectral data is reported above.

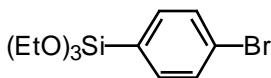

4-Bromo(triethoxysilyl)benzene (Table 10, entry 8). The general procedure for silylation was followed using 1-bromo-4-iodobenzene (1.42 g, 5.00 mmol), *i*-Pr₂NEt (1.94 g, 2.61 mL, 15.0 mmol), Pd(dba)₂ (86 mg, 0.15 mmol), P(*t*-Bu)₂(*o*-biphenyl) (**120**) (90 mg, 0.30 mmol), and triethoxysilane (1.23 g, 1.38 mL, 7.50 mmol) in 20 mL of NMP. The reaction was stirred at 25 °C for 2 h. Bulb-to-bulb distillation (125 °C, 0.5 torr) afforded 1.09 g (68%) of 4-bromo(triethoxysilyl)benzene as a colorless oil. IR (neat) 2975 (s), 2926 (s), 2887 (s), 1575 (m), 1481 (m), 1442 (m), 1390 (m), 1379 (m), 1295 (w), 1165 (s), 1073 (vs) cm⁻¹; ¹H (NMR) (CDCl₃) δ 1.24 (t, *J* = 7.2, 9H), 3.86 (q, *J* = 7.2, 6H), 7.50-7.55 (m, 4H); ¹³C (NMR) (CDCl₃) δ 18.4, 59.0, 125.5, 130.1, 132.3, 136.6; MS (*m/z*) 320 (5), 318 (5), 275 (26), 273 (22), 239 (16), 231 (11), 219 (11), 217 (12), 201 (10), 195 (33), 163 (12), 162 (18), 149 (11), 148 (21), 147 (100), 137 (10), 135 (32); HRMS for C₁₂H₁₉O₃⁷⁹BrSi calcd 318.0287, found 318.0295.

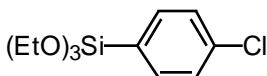

4-Chloro(triethoxysilyl)benzene (Table 10, entry 9). The general procedure for silylation was followed using 1-chloro-4-iodobenzene (1.19 g, 5.00 mmol), *i*-Pr₂NEt (1.94 g, 2.61 mL, 15.0 mmol), Pd(dba)₂ (86 mg, 0.15 mmol), P(*t*-Bu)₂(*o*-biphenyl) (**120**) (90 mg, 0.30

mmol), and triethoxysilane (1.23 g, 1.38 mL, 7.50 mmol) in 20 mL of NMP. The reaction was stirred at 25 °C for 12 h. Bulb-to-bulb distillation (125 °C, 0.5 torr) afforded 1.03 g (75%) of 4-chloro(triethoxysilyl)benzene as a colorless oil. IR (neat) 2975, 2888, 2360, 1699, 1583, 1557, 1485, 1443, 1389, 1296, 1261 cm⁻¹; ¹H (NMR) (CDCl₃) δ 1.17 (t, *J* = 7.0, 9 H), 3.79 (q, *J* = 7.0, 6 H), 7.28 (d, *J* = 8.5, 2 H), 7.54 (d, *J* = 8.5, 2 H); ¹³C (NMR) (CDCl₃) δ 18.1, 58.8, 128.1, 129.5, 136.1, 136.7; MS (*m/z*) 274 (3), 239 (27), 229 (44), 185 (15), 173 (25), 162 (31), 147 (100), 135 (9); HRMS for C₁₂H₁₉O₃ClSi calcd 274.0792, found 274.0792. The IR, ¹H and ¹³C NMR data were identical to published spectral data.²²¹

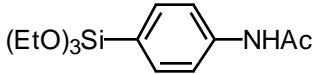
4-(Triethoxysilyl)acetanilide (Table 10, entry 10). The general procedure for silylation was followed using  4-iodoacetanilide (1.31 g, 5.00 mmol), *i*-Pr₂NEt (1.94 g, 2.61 mL, 15.0 mmol), Pd(dba)₂ (86 mg, 0.15 mmol), P(*t*-Bu)₂(*o*-biphenyl) (**120**) (90 mg, 0.30 mmol), and triethoxysilane (1.23 g, 1.38 mL, 7.50 mmol) in 20 mL of NMP. The reaction was stirred at 25 °C for 12h. Bulb-to-bulb distillation (125 °C, 0.5 torr) afforded 1.01 g (68%) of 4-(triethoxysilyl)acetanilide as a colorless oil. Spectral data is reported above.

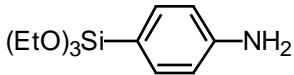
4-(Triethoxysilyl)aniline (Table 10, entry 11). The general procedure for silylation was followed using  4-iodoaniline (1.10 g, 5.00 mmol), *i*-Pr₂NEt (1.94 g, 2.61 mL, 15.0 mmol), Pd(dba)₂ (86 mg, 0.15 mmol), P(*t*-Bu)₂(*o*-biphenyl) (**120**) (90 mg, 0.30 mmol), and triethoxysilane (1.23 g, 1.38 mL, 7.50 mmol) in 20 mL of NMP. The reaction was stirred at 25 °C for 12 h. Bulb-to-bulb distillation (125 °C, 0.5 torr) afforded 983 mg (77%) of 4-(triethoxysilyl)aniline as a colorless oil. Spectral data is reported above.

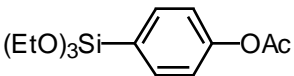
4-Acetoxy(triethoxysilyl)benzene (Table 10, entry 12). The general procedure for silylation was followed using 

4-acetoxyiodobenzene (1.31 g, 5.00 mmol), *i*-Pr₂NEt (1.94 g, 2.61 mL, 15.0 mmol), Pd(dba)₂ (86 mg, 0.15 mmol), P(*t*-Bu)₂(*o*-biphenyl) (**120**) (90 mg, 0.30 mmol), and triethoxysilane (1.23 g, 1.38 mL, 7.50 mmol) in 20 mL of NMP. The reaction was stirred at 25 °C for 12 h. Bulb-to-bulb distillation (125 °C, 0.5 torr) afforded 1.12 g (75%) of 4-acetoxy(triethoxysilyl) benzene as a colorless oil. Spectral data is reported above.

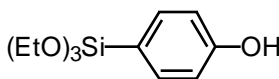

4-(Triethoxysilyl)phenol (Table 10, entry 13). The general procedure for silylation was followed using 4-iodophenol (1.10 g, 5.00 mmol), *i*-Pr₂NEt (1.94 g, 2.61 mL, 15.0 mmol), Pd(dba)₂ (86 mg, 0.15 mmol), P(*t*-Bu)₂(*o*-biphenyl) (**120**) (90 mg, 0.30 mmol), and triethoxysilane (1.23 g, 1.38 mL, 7.50 mmol) in 20 mL of NMP. The reaction was stirred at 25 °C for 12 h. Bulb-to-bulb distillation (125 °C, 0.5 torr) afforded 897 mg (70%) of 4-(triethoxysilyl)phenol as a colorless oil. Spectral data is reported above.

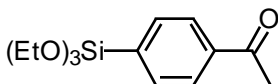

4-(Triethoxysilyl)acetophenone (Table 10, entry 14). The general procedure for silylation was followed using 4-iodoacetophenone (1.23 g, 5.00 mmol), *i*-Pr₂NEt (1.94 g, 2.61 mL, 15.0 mmol), Pd(dba)₂ (86 mg, 0.15 mmol), P(*t*-Bu)₂(*o*-biphenyl) (**120**) (90 mg, 0.30 mmol), and triethoxysilane (1.23 g, 1.38 mL, 7.50 mmol) in 20 mL of NMP. The reaction was heated at 60 °C for 12 h. Bulb-to-bulb distillation (125 °C, 0.5 torr) afforded 339 mg (24%) of 4-(triethoxysilyl)phenol as a colorless oil. IR (neat) 2975 (s), 2927 (s), 2890 (s), 1728 (m), 1689 (s), 1497 (w), 1443 (m), 1390 (m), 1360 (m), 1263 (s), 1167 (s), 1079 (vs) cm⁻¹; ¹H (NMR) (CDCl₃) δ 1.26 (t, *J* = 7.0, 9H), 2.61 (s, 3H), 3.89 (q, *J* = 7.0, 6H), 7.79 (d, *J* = 8.0, 2H), 7.95 (d, *J* = 8.0, 2H); ¹³C (NMR) (CDCl₃) δ 18.3, 26.8, 59.0, 127.4, 135.2, 137.4, 138.4, 198.5; MS (*m/z*) 282 (8), 268 (22), 267 (100), 239 (15), 238 (67), 237 (57), 223 (16), 209 (18), 193 (13), 181 (20), 165 (19), 163 (24), 147 (16), 138 (12), 135 (9); HRMS for C₁₄H₂₂O₄Si calcd 282.1287, found 282.1288.

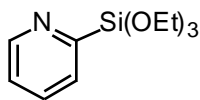

2-(Triethoxysilyl)pyridine (Table 10, entry 15). The general procedure for silylation was followed using 2-iodopyridine (532 μL , 5.00 mmol), *i*-Pr₂NEt (1.94 g, 2.61 mL, 15.0 mmol), Pd(dba)₂ (86 mg, 0.15 mmol), P(*t*-Bu)₂(*o*-biphenyl) (**120**) (90 mg, 0.30 mmol), and triethoxysilane (1.23 g, 1.38 mL, 7.50 mmol) in 20 mL of NMP. The reaction was heated at 60 °C for 12 h. By GCMS of the crude reaction mixture, the reaction yielded pyridine as the major product, and none of the desired silylated product. Bulb-to-bulb distillation (125 °C, 0.5 torr) afforded 50 mg (15%) of 2,2'-dipyridyl (**130**) following purification. For 2,2'-dipyridyl: IR (neat) 3069 (m), 3053 (m), 3011 (w), 1584 (s), 1562 (s), 1467 (s), 1421 (s), 1255 (m), 1147 (m) cm⁻¹; ¹H (NMR) (CDCl₃) δ 7.12 (t, *J* = 7.8, 2 H), 7.66 (t, *J* = 7.8, 2 H), 8.50 (d, *J* = 7.8, 2 H), 8.59 (d, *J* = 7.8, 2 H); ¹³C (NMR) (CDCl₃) δ 121.0, 123.7, 136.8, 149.0, 156.0. The IR, ¹H and ¹³C NMR data were identical to an authentic sample.

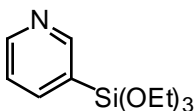

3-(Triethoxysilyl)pyridine (Table 10, entry 16). The general procedure for silylation was followed using 3-iodopyridine (1.03 g, 5.00 mmol), *i*-Pr₂NEt (1.94 g, 2.61 mL, 15.0 mmol), Pd(dba)₂ (86 mg, 0.15 mmol), P(*t*-Bu)₂(*o*-biphenyl) (**120**) (90 mg, 0.30 mmol), and triethoxysilane (1.23 g, 1.38 mL, 7.50 mmol) in 20 mL of NMP. The reaction was heated at 60 °C for 12 h. Bulb-to-bulb distillation (125 °C, 0.5 torr) afforded 121 mg (10%) of 3-(triethoxysilyl)pyridine as a colorless oil. ¹H (NMR) (CDCl₃) δ 1.26 (t, *J* = 6.8, 9H), 3.90 (q, *J* = 6.8, 6H), 7.2-7.3 (m, 1H), 7.95 (d, *J* = 5.9, 1H), 8.65 (d, *J* = 4.9, 1H), 8.83 (s, 1H); ¹³C (NMR) (CDCl₃) δ 18.0, 58.8, 123.1, 126.6, 142.4, 151.1, 155.0; MS (*m/z*) 241 (54), 240 (100), 226 (18), 212 (27), 196 (88), 147 (29), 182 (25); HRMS for C₁₁H₁₉O₃NSi calcd 241.1134, found 241.1112. The IR, ¹H and ¹³C NMR data were identical to published spectral data.²²¹ In our laboratories, using the conditions given by Masuda,²²¹ we obtained a maximum isolated yield of 10% (Masuda reported a 56% yield).

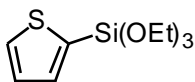

2-(Triethoxysilyl)thiophene (Table 10, entry 17). The general procedure for silylation was followed using 2-iodothiophene (552 μL , 5.00 mmol), *i*-Pr₂NEt (1.94 g, 2.61 mL, 15.0 mmol), Pd(dba)₂ (86 mg, 0.15 mmol), P(*t*-Bu)₂(*o*-biphenyl) (**120**) (90 mg, 0.30 mmol), and triethoxysilane (1.23 g, 1.38 mL, 7.50 mmol) in 20 mL of NMP. The reaction was heated at 60 °C for 12 h. Bulb-to-bulb distillation (125 °C, 0.5 torr) afforded 1.13 g (92%) of 2-(triethoxysilyl)thiophene as a colorless oil. Spectral data is reported above.

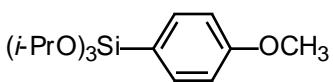

4-(Triisopropoxysilyl)anisole. The general procedure for silylation was followed using 4-iodoanisole (1.17 g, 5.00 mmol), *i*-Pr₂NEt (1.94 g, 2.61 mL, 15.0 mmol), Pd(dba)₂ (86 mg, 0.15 mmol), P(*t*-Bu)₂(*o*-biphenyl) (**120**) (90 mg, 0.30 mmol), and triisopropoxysilane (1.55 g, 1.50 mL, 7.50 mmol) in 20 mL of NMP. The reaction was heated at 80 °C for 12 h. Bulb-to-bulb distillation (125 °C, 0.5 torr) afforded 1.17 g (75%) of 4-(triisopropoxysilyl)anisole as a colorless oil. IR (neat) 2972 (s), 2934 (m), 2896 (m), 1597 (s), 1505 (m), 1381 (m), 1369 (m), 1281 (m), 1252 (m), 1174 (s), 1124 (vs) cm⁻¹; ¹H (NMR) (CDCl₃) 1.20 (d, *J* = 6.1, 18 H), 3.81 (s, 3 H), 4.25 (septet, *J* = 6.1, 3 H), 6.90 (d, *J* = 8.7, 2 H), 7.61 (d, *J* = 8.7, 2 H) δ ; ¹³C (NMR) (CDCl₃) 25.5, 54.9, 65.3, 113.4, 123.8, 136.6, 161.1 δ ; MS (*m/z*) 314 (17), 299 (9), 253 (72), 211 (15), 205 (38), 187 (15), 167 (100), 147 (15), 121 (20); HRMS for C₁₆H₂₈O₄Si calcd 312.1757, found 312.1772.

General Procedure for the Homocoupling of 2-Halopyridines under Palladium

Catalysis. The indicated 2-halopyridine (1.00 mmol, 1.0 equiv), and *i*-Pr₂NEt (388 mg, 523 μL , 3.00 mmol) were added to a stirring solution of Pd(dba)₂ (29 mg, 0.05 mmol), P(*t*-Bu)₂(*o*-biphenyl) (**120**) (30 mg, 0.1 mmol), and the internal standard naphthalene (128 mg, 1.0 mmol, 1.0 equiv) in 4 mL of NMP under an atmosphere of argon. The reaction was heated at 60 °C for 12 h. Progress was monitored by GC analysis of aliquots of the quenched reaction mixture. GC response factors relative to the internal naphthalene

standard were determined, and the observed percentages of products were normalized accordingly. The homocoupled product 2,2'-dipyridyl was identified by comparison of the GC retention time to that of an authentic sample.

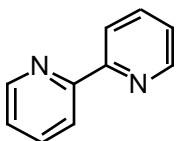

2,2'-Dipyridyl (130). The general procedure for homocoupling was followed using 2-iodopyridine (**129**) (205 mg, 106 μ L, 1.00 mmol), *i*-Pr₂NEt (388 mg, 523 μ L, 3.00 mmol), Pd(dba)₂ (29 mg, 0.05 mmol), and P(*t*-Bu)₂(*o*-biphenyl) (**120**) (30 mg, 0.1 mmol), in 4 mL of NMP at 60 °C for 12 h gave 99% **130** by G.C. analysis.

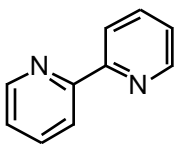

2,2'-Dipyridyl (130). The general procedure for homocoupling was followed using 2-bromopyridine (**42**) (158 mg, 95 μ L, 1.00 mmol), *i*-Pr₂NEt (388 mg, 523 μ L, 3.00 mmol), Pd(dba)₂ (29 mg, 0.05 mmol), and P(*t*-Bu)₂(*o*-biphenyl) (**120**) (30 mg, 0.1 mmol), in 4 mL of NMP at 60 °C for 12 h gave 2% **130** and 25% pyridine by G.C. analysis. The remaining percentage was unreacted starting material.

General Procedure for the Optimization of the Silylation of Aryl Triflates (131) (Table 11). The indicated aryl triflate (1.00 mmol, 1.0 equiv), and base (3.00 mmol, 3.0 equiv) were added to a stirring solution of Pd(dba)₂ (29 mg, 0.05 mmol, 5 mol %), the phosphine (0.10 mmol, 10 mol%), and the internal standard naphthalene (128 mg, 1.0 mmol, 1.0 equiv) in 4 mL of solvent under an atmosphere of argon. Triethoxysilane (246 mg, 277 μ L, 1.50 mmol, 1.5 equiv) was added, causing bubbling, formation of yellow foam, and darkening of the reaction mixture. The reaction mixture was allowed to stir at room temperature for 12 h. Progress was monitored by GC analysis of aliquots of the quenched reaction mixture. GC response factors relative to the internal naphthalene standard were determined, and the observed percentages of products were normalized

accordingly. The reduced product **121** was identified by comparison of the GC retention time to that of an authentic sample.

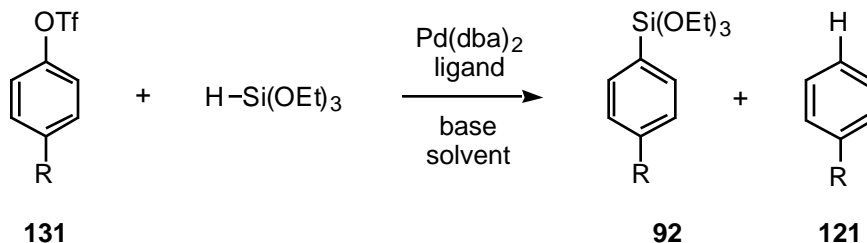

Entry	Conditions ^a				Yield (%) ^{b,c}	
	R	Ligand	Base	Solvent	92	121
1	OMe	P(<i>t</i> -Bu) ₂ (<i>o</i> -biphenyl)	<i>i</i> -Pr ₂ NEt	NMP	3	90
2	OMe	P(<i>t</i> -Bu) ₂ (<i>o</i> -biphenyl)	none	NMP	0	5
3	OMe	P(<i>t</i> -Bu) ₂ (<i>o</i> -biphenyl)	<i>i</i> -Pr ₂ NEt	dioxane	2	96
4	OMe	P(<i>t</i> -Bu) ₂ (<i>o</i> -biphenyl)	none	dioxane	0	7
5	OMe	PPh ₃	<i>i</i> -Pr ₂ NEt	NMP	0	5
6	OMe	PPh ₃	<i>i</i> -Pr ₂ NEt	dioxane	0	24
7	OMe	P(cy) ₂ (<i>o</i> -biphenyl)	<i>i</i> -Pr ₂ NEt	NMP	1	32
8	OMe	P(cy) ₂ (<i>o</i> -biphenyl)	<i>i</i> -Pr ₂ NEt	dioxane	1	99
9	NO ₂	P(<i>t</i> -Bu) ₂ (<i>o</i> -biphenyl)	<i>i</i> -Pr ₂ NEt	NMP	0	100
10	NO ₂	P(<i>t</i> -Bu) ₂ (<i>o</i> -biphenyl)	none	NMP	0	22
11	NO ₂	P(<i>t</i> -Bu) ₂ (<i>o</i> -biphenyl)	<i>i</i> -Pr ₂ NEt	dioxane	0	100
12	NO ₂	P(<i>t</i> -Bu) ₂ (<i>o</i> -biphenyl)	none	dioxane	0	15
13	NO ₂	PPh ₃	<i>i</i> -Pr ₂ NEt	NMP	0	100
14	NO ₂	PPh ₃	<i>i</i> -Pr ₂ NEt	dioxane	0	100
15	NO ₂	P(cy) ₂ (<i>o</i> -biphenyl)	<i>i</i> -Pr ₂ NEt	NMP	0	100
16	NO ₂	P(cy) ₂ (<i>o</i> -biphenyl)	<i>i</i> -Pr ₂ NEt	dioxane	0	100

^a Reactions of aryltriflate (**131**) (1.0 mmol) with H-Si(OEt)₃ (1.5 mmol) were performed at room temperature for 12h in 4 mL of solvent by using Pd(dba)₂ (5 mol %), phosphine (10 mol %), and base (3 mmol). ^b GC yields are based on amount of aryltriflate (**131**).

^c Remaining percentage was unreacted starting material.

Table 11. Silylation of Aryltriflate Derivatives.

General Procedure for the Optimization of the Silylation of Aryl Halides or Acyl Chlorides Using Hexamethoxydisilane (Table 12 and Scheme 71). The indicated aryl halide or acyl chloride (1.00 mmol, 1.0 equiv), and base (3.00 mmol, 3.0 equiv) were added to a stirring solution of palladium catalyst (0.05 mmol, 5 mol %), the phosphine

(0.10 mmol, 10 mol%), and the internal standard naphthalene (128 mg, 1.0 mmol, 1.0 equiv) in 4 mL of solvent under an atmosphere of argon. Hexamethoxydisilane (364 mg, 332 μ L, 1.50 mmol, 1.5 equiv) was added, causing darkening of the reaction mixture. The reaction mixture was allowed to stir at the given temperature for 12 to 48 h. Progress was monitored by GC analysis of aliquots of the quenched reaction mixture. GC response factors relative to the internal naphthalene standard were determined, and the observed percentages of products were normalized accordingly. The reduced product **121** and methylbenzoate were identified by comparison of the GC retention time to that of an authentic sample.

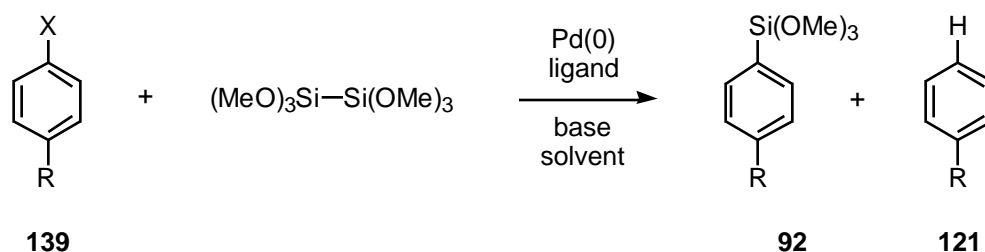

Entry	Substrate		Conditions ^a				Yield (%) ^{b,c}	
	X	R	Ligand	Pd catalyst / base	solvent	T (°C)	92	121
1	I	OMe	P(<i>t</i> -Bu) ₂ (<i>o</i> -biphenyl)	Pd(dba) ₂ / <i>i</i> -Pr ₂ NEt	NMP	25	0	0
2	I	OMe	P(<i>o</i> -tol) ₃	Pd(dba) ₂ ·CHCl ₃ / <i>i</i> -Pr ₂ NEt	NMP	25	0	2
3	Br	OMe	P(<i>t</i> -Bu) ₂ (<i>o</i> -biphenyl)	Pd(dba) ₂ / <i>i</i> -Pr ₂ NEt	NMP	25	0	0
4	Cl	OMe	P(<i>t</i> -Bu) ₂ (<i>o</i> -biphenyl)	Pd(dba) ₂ / <i>i</i> -Pr ₂ NEt	NMP	25	0	0
5	Br	Ac	P(<i>t</i> -Bu) ₂ (<i>o</i> -biphenyl)	Pd(dba) ₂ / <i>i</i> -Pr ₂ NEt	NMP	100	0	100
6	Br	Ac	P(<i>t</i> -Bu) ₂ (<i>o</i> -biphenyl)	Pd(dba) ₂ / <i>i</i> -Pr ₂ NEt	DMPU	100	0	100
7	I	Ac	P(<i>t</i> -Bu) ₂ (<i>o</i> -biphenyl)	Pd(dba) ₂ / KF (aq)	DMPU	75	0	100
8	Br	Ac	P(<i>t</i> -Bu) ₂ (<i>o</i> -biphenyl)	Pd(dba) ₂ / KF (aq)	DMPU	75	0	100
9	Br	OMe	P(<i>t</i> -Bu) ₂ (<i>o</i> -biphenyl)	Pd(dba) ₂ / K ₂ CO ₃ (aq)	DMPU	75	0	0
10	I	OMe		Pd(PPh ₃) ₄ / TBAF	NMP	25	0	0
11	I	Me		Pd(PPh ₃) ₄ / TBAF	DMF	25	0	3
12	I	Me		Pd(PPh ₃) ₄ / TBAF	HMPA	25	0	3
13 ^{d,e}	Br	H		Pd(PPh ₃) ₄	toluene	140	27	10

^a Reactions of aryl halide **139** (1.0 equiv) with (MeO)₃Si-Si(OMe)₃ (2.0 equiv) were performed using the indicated temperature and solvent for 12h-48h by using the given palladium catalyst (5 mol %), phosphine (10 mol %), and base (3 equiv). ^b GC yields are based on amount of aryl halide **139**. ^c Unless otherwise noted, remaining percentage was unreacted starting material (**139**). ^d Reaction was performed in a sealed tube for 72h. ^e Biphenyl was observed in 7% yield.

Table 12. Silylation of Arylhalides Using Hexamethoxydisilane.

Chapter 2. Trimethylsilyl Cyanide As A Cyanide Source For Nucleophilic Substitution

Introduction

Fluoride Ion Activation of Silicon Bonds

The study of pentacoordinate and hexacoordinate organosilicon derivatives is approximately a century old. Hypercoordinate organosilicon compounds have been studied since the early 19th century when Dilthey reported the first known hypercoordinate organosilicates, six-coordinate silicon diketonates.¹⁻⁴ To date, a wide variety of penta- and hexacoordinate organosilicon compounds have been synthesized and characterized; surprisingly, despite the nonexistence of naturally-occurring organosilicates,^{5,6} a handful of silicates which have no carbon analogs are biologically active.⁷⁻¹³ The synthesis and structure of hypercoordinate silicates most notably have been studied and reviewed by Voronkov,^{1,14-19} Frye^{12,20-33} and Lukevics.³⁴⁻⁴¹ In turn, Corriu⁴²⁻⁴⁶ has investigated and extensively reviewed silicate reactivity and reaction mechanisms.

Hypercoordinate silicates first became an area of active research in the DeShong laboratories with the synthesis of tetrabutylammonium triphenyldifluorosilicate (TBAT, **1**, Scheme 1).⁴⁷⁻⁵¹ TBAT was initially developed as a source of nucleophilic fluoride ion for S_N2-type displacements⁴⁸ and for Si-C bond cleavage.⁴⁷ Stable, crystalline, non-basic, and non-hygroscopic, pentacoordinate silicate **1** is an excellent fluoride surrogate when compared to alkali metal fluorides or tetraalkylammonium fluorides (Scheme 1, eq. a). More recently, TBAT has been developed as a highly effective phenylation reagent in palladium-catalyzed cross coupling reactions, offering a silicon-based alternative to Suzuki (boron) and Stille (tin) reagents (Scheme 1, eq. b).⁵⁰

Scheme 1

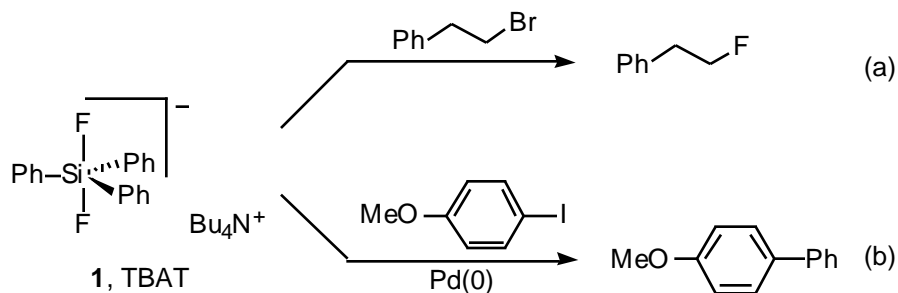

Relative to other fluoride sources, TBAT was shown to yield less alkene elimination by-products in standard nucleophilic displacements of primary and secondary alkyl halides and sulfonates. Most notably, when compared to the popular organic-soluble reagent tetrabutylammonium fluoride ($\text{Bu}_4\text{N}^+ \text{F}^-$, TBAF), TBAT is far less basic. For example in Scheme 2, whereas TBAT achieved nearly quantitative fluoride displacement of a secondary alkyl tosylate, TBAF provoked elimination leading to alkene by-products.

Scheme 2

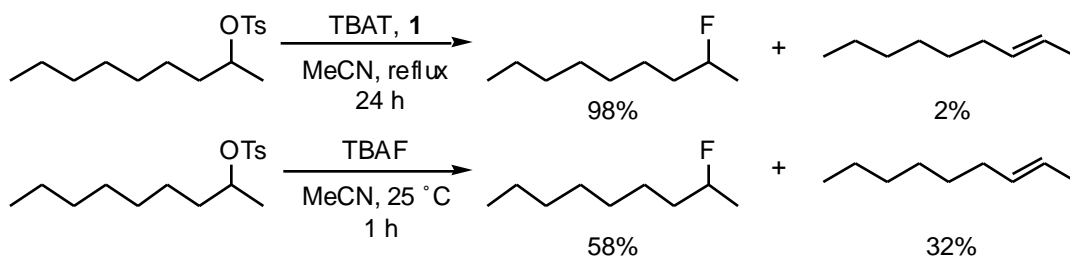

It is also noteworthy that reactions with TBAT proceeded much more slowly than the corresponding reaction with anhydrous TBAF. Based on the observed rate difference as well as NMR spectroscopic studies, it was concluded that TBAT does not operate by a simple *in situ* disproportionation to TBAF (Scheme 3) and fluorotriphenylsilane (**2**). Instead, the hypercoordinate silicate itself must directly transfer a softer, less basic fluoride nucleophile to the substrate.

Scheme 3

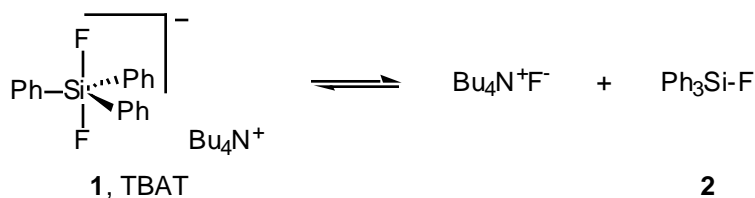

Given the effectiveness of TBAT as a practical reagent for the delivery of fluoride anion, extension of this strategy to deliver other nucleophiles by generating the reactive hypercoordinate silicate *in situ* was investigated (Scheme 4). In this chapter, it is reported that trimethylsilyl cyanide (Me_3SiCN , **3**) and trimethylsilyl azide (Me_3SiN_3 , **4**) underwent reaction with tetrabutylammonium fluoride (TBAF) to generate the respective hypercoordinate trimethylfluorosilicate (**5** or **6**) *in situ*. Analogous with the observations using TBAT, silicates **5** and **6** were extremely reactive alternates of cyanide and azide anion, respectively, for $\text{S}_{\text{N}}2$ displacement (*vide infra*).⁵²⁻⁵⁴

Scheme 4

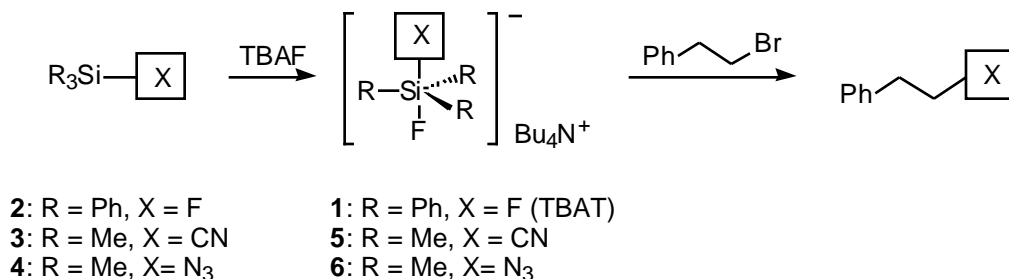

The chemistry described in Scheme 4 is one of the characteristic reactions of tetracoordinate silanes: the activation of Si-H, Si-O, Si-C, Si-N, or Si-M (M = Si, Ge, Sn) bonds by addition of a nucleophile, typically fluoride ion. The Si-X bonds of tetracoordinate silanes normally are not labile in the absence of nucleophilic activation. Pentacoordinate silicates such as **5** and **6** are widely accepted as the reactive intermediates in most reactions at silicon, and many new isolable hypercoordinate silicates have been synthesized as probes of the mechanism of the reactions of silanes.^{43 Chap. 1,44}

In his dissertation on the development of TBAT as a fluorinating reagent, Pilcher presented the properties, reactivity, and methods of analysis of hypercoordinate fluorosilicates.⁵⁵ The aim of this chapter is twofold: to review the literature precedence which supports the existence of hypercoordinate intermediates such as **5** and **6**, and to present pertinent examples of fluoride-mediated reactions of silanes. The following features are discussed:

1. The expansion of coordination at silicon. Formation of pentacoordinate silicon has been proposed as the fundamental step of most transformations of silicon compounds.^{43 Chap. 1,44} Examples of isolable pentacoordinate silicates are presented as analogues of the key pentacoordinate reaction intermediates **5** and **6**. In addition, analytical methods for the characterization of hypercoordinate silicates are discussed.
2. Mechanisms of nucleophilic substitutions at silicon. The process depicted in Scheme 4 involves nucleophilic attack on silicon by fluoride ion, and displacement of the group X (cyanide or azide). Nucleophilic substitutions at silicon take place via the hypercoordinate intermediate, such as **5** and **6**, and not through an S_N1 or S_N2-type process.
3. Pertinent examples of fluoride ion activation of silicon bonds in organic synthesis, encompassing desilylation (removal of protecting groups), reduction, and group transfer reactions (allylation, arylation, acylation, etc.). Particular attention will be paid to experimental evidence for the participation of hypercoordinate silicate intermediates.

Finally, the results of studies in the DeShong lab on the use of organosilicon compounds under nucleophile-activated conditions are presented, and discussed.

Atomic and Molecular Properties of Tetracoordinate and Hypercoordinate Organosilicates

Silicon compounds are often compared to their carbon-based analogues: silicon is in the same period of the periodic table as carbon; intuitively, their chemistries should be similar. Silanes, like alkanes, are neutral, tetracoordinate species. However, beyond sharing a valence number of four, the properties of carbon and silicon compounds are surprisingly different. On the basis of this periodic proximity of silicon to carbon, the first researchers of silicon chemistry correctly postulated that silicon compounds should undergo similar chemical transformations, most notably nucleophilic substitution.⁵⁶ However, fundamental differences in the atomic and molecular natures of silicon and carbon cause a divergence in their respective mechanistic pathways to nucleophilic substitution. The larger atomic size, lower electronegativity, and the availability of low energy *d* orbitals endow silicon with enhanced reactivity, and metallic properties.

The most notable contrast between silicon and carbon is that silicon can expand beyond its normal coordination number of four, becoming what is termed hypercoordinate. Silicates are a class of anionic compounds featuring a silicon atom with five (**7** and **8**) or six (**9**) ligands as opposed to the normal silane coordination number of four.

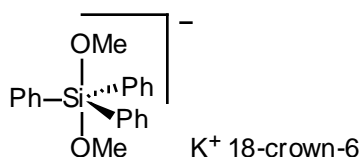

7

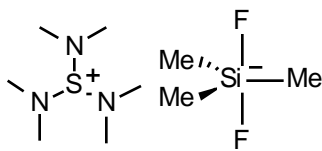

TAS-F, **8**



9

The ability of silicon to become hypercoordinate is due to a number of steric and electronic factors (Table 1). With a significantly larger covalent radius than carbon, silicon can satisfy the steric demands of penta- and hexacoordination.^{55,57} Addition of an anion to tetracoordinate silicon is a lower energy process than for carbon, as indicated by the higher silicon electron affinity.⁵⁸ Conversely, silicon has a lower ionization potential than carbon, allowing ligands to share the negative charge on, and thereby stabilize a penta- or hexacoordinate complex.⁵⁹

Si	Atomic Property	C
1.06 Å	atomic radius ⁶⁰	0.66 Å
1.17 Å	covalent radius ⁶¹	0.77 Å
3.35 eV for F ₃ Si [•]	electron affinity ⁵⁸	1.85 eV for CF ₃ C [•]
8.15 eV	ionization potential ⁵⁹	11.26 eV
1.74	Allred-Rochow electronegativity ^{56,62}	2.50

Table 1. Comparison of Atomic Properties of Si and C.

The relatively low silicon electronegativity has two major consequences: (1) silicon is often polarized in the opposite sense to carbon (i.e., Ph₃Si^{δ+}-H^{δ-} vs. Ph₃C^{δ-}-H^{δ+}); and (2) the Si-X and Si-O bonds are highly polarized—much more so than C-X and C-O bonds—rendering silicon more electrophilic and susceptible to nucleophilic attack.⁵⁶ Using *ab initio* methods and experimentally determined heats of reaction to compare the structures and bond energies of silyl (H₃Si-X) and methyl (H₃C-X) derivatives (X = Li, BeH, BH₂, CH₃, NH₂, OH, F, and Na), Schleyer demonstrated that the relative Si-X and C-X bond energies are directly proportional to the electronegativity of the group X.⁶³ For reference, Table 2 lists the relative electronegativities of the atoms to which silicon typically forms bonds. In addition, Schleyer described the Si-X covalent bond as more ionic (Si^{δ+}-X^{δ-}) in nature than the predominantly covalent C-X bond.⁶⁴

As indicated by the bond dissociation energies (Table 3), silicon forms remarkably strong bonds to F and O, and somewhat weak bonds to Si, and H. In contrast, carbon forms strong C-C and C-H bonds, and relatively weak C-O and C-X bonds. The weak Si-H bond explains in part why hydrosilanes are good reducing agents, in stark contrast to alkanes.⁵⁶ Also, formation of the strong Si-F bond is often the thermodynamic driving force of reactions at silicon; fluoride is typically the unrivaled catalyst for the cleavage of other Si-X bonds.⁴² Note that, although the Si-Cl and Si-F bond strengths are greater than the C-Cl and C-F bond strengths, the Si-X bonds are kinetically quite reactive (readily broken), and more labile than the equivalent C-X bond. This discrepancy between kinetic reactivity and thermodynamic bond strength in substitution reactions at silicon in comparison to carbon is attributed in part to the attraction of nucleophiles to the larger partial positive charge on Si.^{43,56,61}

Atom	Electronegativity	Atom	Electronegativity
F	4.10	S	2.44
CN	3.60	H	2.20
O	3.50	As	2.20
OH	3.50	P	2.06
N	3.07	Ge	2.02
NH ₂	3.05	B	2.01
OCH ₃	2.90	BH ₂	1.90
Cl	2.83	Si	1.74
Br	2.74	BeH	1.50
C	2.50	Al	1.47
Se	2.48	Na	1.01
CH ₃	2.45	Li	0.97

Table 2. Atomic and Group Allred-Rochow Electronegativities.^{56,62}

Bond to	Bond Energy (kJ mol ⁻¹) ^{61,65}		Bond Length (Å) ⁵⁶	
	C	Si	C ⁶⁶	Si ^{67,68}
F	485	582	1.39	1.6
Cl	327	391	1.78	2.05
Br	285	310	1.94	2.21
I	213	234	2.14	2.44
O	336	368	1.41	1.63
N	335	400	1.47	1.74
C	356	373	1.53	1.87
Si	250-335	210-250	1.87	2.34

Table 3. Approximate Average Bond Dissociation Energies and Bond Lengths for Tetravalent C and Si.

X-Ray crystallographic studies of stable, solid silicates show that tetracoordinate, pentacoordinate and hexacoordinate silicon compounds adopt the tetrahedral, trigonal bipyramidal (TBP), and octahedral geometries, respectively (Figure 1).¹ Most known silicon compounds are tetrahedral ($3sp^3$ hybridized).⁵⁶ Tetrahedral silanes exhibit high configurational stability, albeit lower than carbon,⁴⁴ and chiral silanes have been synthesized predominantly for use as stereochemical probes of the mechanism of nucleophilic displacement at Si.^{33,44-46,69-71}

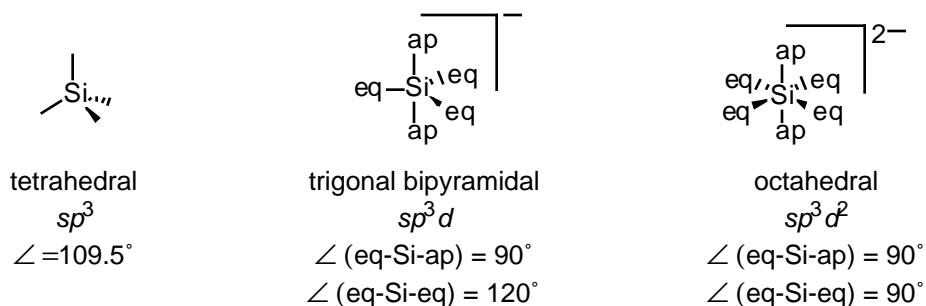
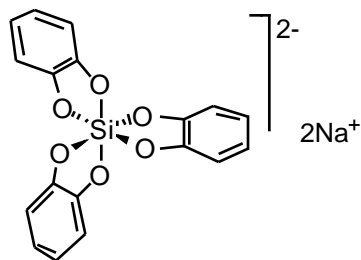

Figure 1. Hybridization of Tetra-, Penta-, and Hexacoordinate Silicon.

Pentacoordinate complexes are trigonal bipyramidal (TBP) ($3sp^3d$ hybridized) with distinct apical (ap) and equatorial (eq) ligands (Figure 1); the apical bonds (pd -like) are longer and weaker than the equatorial bonds (sp^2 -like).^{1,72} “Bent’s Rule” dictates that electronegative groups prefer to occupy the apical sites.⁷³⁻⁷⁵ Electron-withdrawing groups (EWG) tend to decrease the apical silicon-ligand bond lengths and thus increase the overall stability of the complex. Unless a ligand in the complex bears a neutralizing positive charge, the complex bears a negative charge.

Octahedral silicates bear a negative two charge, again, unless cationic ligands are present to neutralize the overall charge (as in compounds **9** and **11**). A large number of hexacoordinate silicates have been synthesized and isolated, two of which are shown below. The triscatecholate silicate **10** was isolated by Corriu, and shown to be a useful starting material for the preparation of alkylsilanes.⁷⁶ Stacked arrays of phthalocyanine derivative **11** are electrically conductive.⁷⁷⁻⁸¹



10

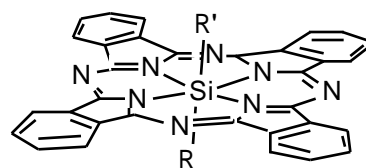

11

The results of calculation and experimentation indicate that the negative charge lies on the ligands, with the most electronegative ligands bearing the brunt of the charge.⁸² Remarkably, as a silicon complex goes from neutral (tetra-coordinate) to anionic (penta-, and then hexacoordinate), the silicon center becomes increasingly positive, and electrophilic.¹ In turn, the ligands become more negative, and nucleophilic. For example, the CNDO/2 calculated charges on the central Si atom of SiF_4 and SiF_5^- are +1.214 and +2.028, respectively; in turn, the charges on the fluorine ligands are -0.304 (sp^3), and -0.399(eq)/-0.415(ap), respectively.⁸³ The net effect of hypercoordination on the reactivity of a silicate is enhanced ligand Lewis basicity, and increased silicon Lewis acidity.¹

Corriu illustrated the “snowball effect” of increasing electrophilicity at silicon with increasing coordination number by demonstrating that the rate of conversion from tetra- (**12**) to pentacoordinate (**13**) is slower than the analogous conversion from penta- (**14**) to hexacoordinate (**15**) for a series of catechol derivatives (Figure 2).⁸⁴ The researchers attributed the observed $k_{\text{pent}} < k_{\text{tet}}$ to the increased electrophilicity at silicon, with the caveat that the rate enhancement may be partially caused by the increased steric accessibility of nucleophiles to pentacoordinate silicon.

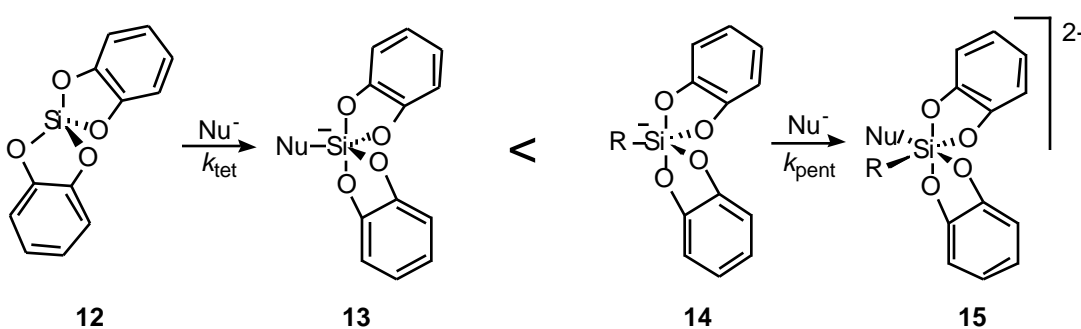

Figure 2. Comparison of Rates of Expansion of Coordination.

Corriu also demonstrated the enhanced ligand nucleophilicity of hypercoordinate silicates relative to the tetracoordinate analogs by comparing the rates at which they perform reduction and group transfer reactions.⁴² For example, as a hydride donor, H–Si(OMe)₃ is significantly weaker than [H–Si(OMe)₄][–]. In parallel, (allyl)SiF₃ is a weaker allylating agent than [(allyl)SiF₄][–]. This aspect of hypercoordination will be discussed in detail later.

As alluded to above, bond lengths to silicon increase with increasing coordination number.¹ The Si-F bond lengths in the series SiF₄, SiF₅[–], and SiF₆^{2–}, are calculated to be (in Å) 1.875, 1.890(eq)/1.900(ax), and 1.930, respectively.⁸³ Even for asymmetrically substituted silanes, an increase in the coordination number of silicon results in the lengthening of all bonds.¹ In terms of reactivity, the silicon atom of pentacoordinate silicates is more sterically accessible than tetrahedral silicon; in other words, pentacoordinate silicates are more sterically vulnerable to nucleophilic attack than tetracoordinate silanes.⁵⁶

Synthesis, Stability and Characterization of Hypercoordinate Organosilicates

Methods for the synthesis of silicates can be summarized as follows (Scheme 5): (a) addition of an anion to a tetracoordinate silane; (b) addition of a neutral electron pair donor to a tetracoordinate silane, either intra- or intermolecularly; and (c) substitution by a chelating ligand.⁴² The synthesis of silicates is extensively reviewed.⁸⁵

Scheme 5

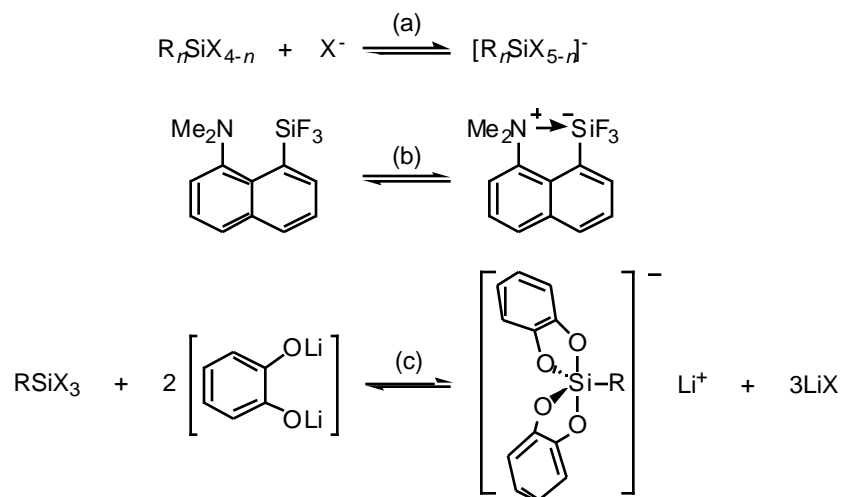

Each of the general synthetic methods presented in Scheme 5 involves attack on silicon by a nucleophile. The reaction ordinarily proceeds if (1) the nucleophile is highly Lewis basic and silaphilic (i.e., F, O, imidazole); and (2) at least two strong EWG (F, O) or at least one strong and one weak, polarizable EWG (phenyl, vinyl) are attached to silicon; otherwise, the reaction equilibrium favors the starting materials.^{55,56} The Lewis acidity of silicon, and therefore the reactivity toward nucleophiles, generally increases in the following order, as predicted by the increasing electron-withdrawing effect of the ligands: $R_3SiX < R_2SiX_2 < RSiX_3 < SiX_4$.⁵⁶

The following observation illustrates the delicate balance of nucleophile Lewis basicity and silane electrophilicity needed for the formation of a stable hypercoordinate silicate:⁵⁶ no product is isolated when $SiCl_4$ is treated with KCl ; however, when $SiCl_4$ is treated with 2 equiv of pyridine, a better Lewis base than Cl^- , $SiCl_4(pyr)_2$ is readily formed. In contrast to $SiCl_4$, $MeSiCl_3$ does not form an isolable pyridine adduct, due to the reduction of silicon Lewis acidity caused by methyl substitution.

Many of the best-known organosilicates are derivatives of ethylene glycol, catechol, or triethanolamine.¹ The trend for silicate stability as derived from the chelate effect is illustrated in Scheme 6; Lehn established that each addition of a bridging ligand increases the stability of the complex by several orders of magnitude.⁸⁶

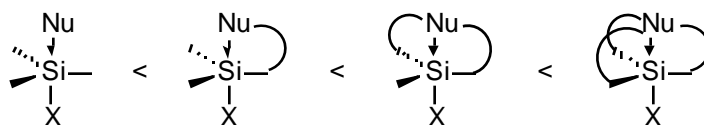
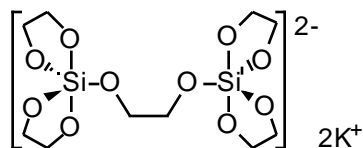
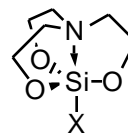

Figure 3. Increase in Silicate Stability Due Chelating Ligands.

The chelate effect has been exploited often: particularly remarkable is the formation of a stable pentacoordinate silicate (**16**) from weakly Lewis acidic silica (SiO_2) in refluxing KOH /ethylene glycol.^{87,88} Finally, silatranes (**17**) have been extensively studied, due to the transannular Si-N dative bond, high stability, and unusual lack of reactivity toward nucleophilic substitution at silicon.^{8-13,89}



16



17

Organosilicates are characterized by a number of standard organic techniques (IR, MS, X-ray crystallography), however the single most diagnostic method for determining the solution-phase structure is NMR spectroscopy. The NMR characterization of organosilicates is extensively reviewed.⁹⁰⁻⁹⁷ Organosilicates ordinarily bear at least three detectable nuclei, ^1H , ^{13}C , and ^{29}Si ; additionally, given the preponderance of organofluorosilicates, ^{19}F NMR is commonly available as an analytical tool.

^{29}Si NMR is the most diagnostic NMR technique for the determination of hypercoordination,⁵⁶ despite the relatively lengthy acquisition times caused by the low sensitivity (7.84×10^{-3} relative to ^1H) and natural abundance (4.70 %) of ^{29}Si , long spin-lattice relaxation times (T_1) and negative gyromagnetic ratio.⁹⁸ These shortcomings are upstaged by the very large chemical shift range (-180 to 250 ppm), and extreme sensitivity of the chemical shift to changes in silicon coordination number. A dramatic upfield shift (between 40 and 80 ppm) accompanies coordination expansion from tetra- to pentacoordinate. Typically, tetracoordinate silicon occurs in a range from 45 to -115 ppm. Five- and six-coordinate silicates are more shielded, occurring in the range from -70 to -200 ppm.⁹³ For example (Table 4), the conversion of triphenylsilyl fluoride (**2**, Ph_3SiF) to TBAT (**1**, $[\text{Ph}_3\text{SiF}_2][\text{Bu}_4\text{N}]^+$) causes an upfield shift from -4.0 to -106.3 ppm.^{47-49,55} For fluorosilanes, Si-F coupling ($J_{\text{Si-F}}$) is reduced by 40 to 80 Hz upon extracoordination as a result of the change in hybridization at silicon. Using the same example, the conversion of triphenylsilyl fluoride (**2**) to TBAT (**1**) causes a decrease in $J_{\text{Si-F}}$ from 282 to 251 Hz.^{47-49,55}

Compound	²⁹ Si (ppm)	¹⁹ F (ppm)	¹³ C ^a (ppm)	<i>J</i> _{Si-F} (Hz)	² <i>J</i> _{C-F} (Hz)
SiPh ₃ F, 2	-4.0, d	-87.5	132.5, d	282	17
[Ph ₃ SiF ₂][Bu ₄ N] ⁺ , 1	-106.3, t	-17.9	128.2, d	251	163
Δ =	-102.3	+69.6	-4.3	-31	+146
Ph ₂ SiF ₂	8.7, d	-64.3	(b)	281	(b)
[Ph ₂ SiF ₃][Bu ₄ N] ⁺	-108.7, q	-74.0	(b)	240	(b)
Δ =	-73	+9.7	(b)	-41	(b)

^a Value for the carbon directly attached to silicon. ^b No quaternary signal observed.

Table 4. Comparison of NMR Data for Tetracoordinate and Pentacoordinate Silicates (25 °C, CDCl₃).^{47-49,55}

Experience garnered in the DeShong lab has shown that prolonged exposure of silicates to the NMR solvent CDCl₃ can result in decomposition of the silicate.⁴⁹ Presumably due to traces of acid in commercial grade deuterated chloroform, TBAT (**1**) undergoes slow decomposition upon standing in CDCl₃ as observed by ¹H and ¹⁹F-NMR spectroscopy. It was shown that freshly made solutions showed no evidence of decomposition for several hours, allowing for the acquisition of clean spectra.

Mechanisms of Nucleophilic Substitution Reactions at Silicon

The ability of silanes to become hypercoordinate has a profound effect on the mechanisms of substitution reactions at silicon. Specifically, where carbon compounds can undergo S_N1 or S_N2 substitution, the accepted mechanisms for silicon substitution typically involve a hypercoordinate silicate intermediate.^{43 Chap. 1,44} Investigations into the mechanism of nucleophilic substitution at silicon have employed the same techniques used to elucidate the mechanism of nucleophilic substitution at carbon.⁴⁴ The classic identifiers of carbon or silicon substitution mechanisms (S_N1 vs. S_N2) are kinetics (unimolecular or bimolecular), stereochemistry (racemization or inversion) and solvent effects.⁹⁹ Three reasonable mechanistic pathways for nucleophilic substitution at silicon have been investigated: S_N1 processes, involving a silylium (R₃Si⁺) intermediate; S_N2-

type processes; and a free-radical pathway, consisting of a one-electron transfer from the electron-rich nucleophile to the electrophilic silicon center.⁴⁴

Highly substituted organic halides undergo nucleophilic substitution, typically solvolysis, *via* an achiral carbocation intermediate with concomitant racemization (S_N1).¹⁰⁰ In contrast, even when substituted by highly stabilizing groups (vinyl, ferrocenyl), chiral monofunctional triarylsilanes do not undergo S_N1 substitution (Scheme 6), as demonstrated by substitution with a high degree of stereochemical retention or inversion.¹⁰¹⁻¹⁰⁸ Formation of the silylium intermediate (**18**) is energetically feasible, but is kinetically outpaced by bimolecular processes.^{44,109,110} Eaborn demonstrated the formation of the silylium intermediate through kinetic and stereochemical studies of the methanolysis of highly sterically hindered, S_N2 -suppressed silanes.¹¹¹ Exceptionally hindered substrates aside, silylium ions are not intermediates in the majority of solution-phase reactions, including nucleophilic substitution.^{44,56}

Scheme 6

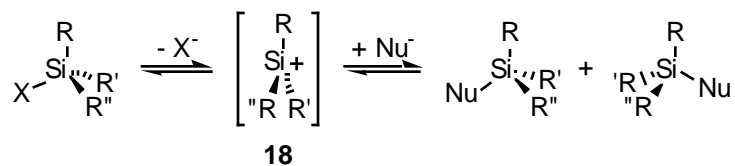

Racemization under solvolysis conditions has been observed, with or without the inclusion of an acid catalyst (Scheme 7). Racemization is not attributed to the formation of a silylium intermediate, however, but rather to equilibration and formation of an achiral, symmetrical pentacoordinate intermediate (**19**). In order for equilibration and racemization to ensue, the leaving group and the nucleophile must either be the same species,⁵⁶ or be thermodynamically similar (i.e., the Si-X bond strengths must be approximately equal, to allow equilibration to occur, i.e., X = Cl, Nu = NR₃).¹¹²⁻¹¹⁴

Scheme 7

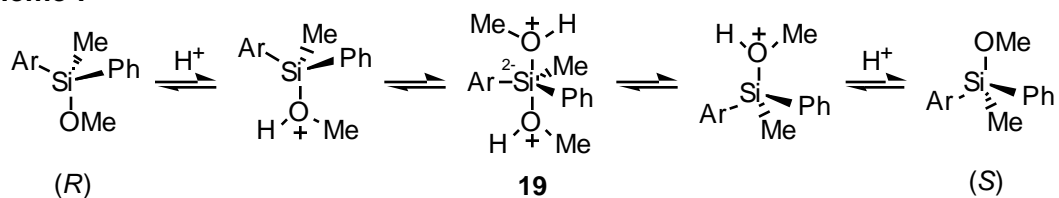

Single-electron transfer (SET) mechanisms similarly have been ruled out.⁴⁴ In analogy to SET substitution reactions of carbon compounds, it is feasible that silicates could undergo nucleophilic substitution through a single-electron transfer from the electron-rich nucleophile to electrophilic silicon (Scheme 8).⁴⁴ However, electrochemical data (half-wave reduction potentials) indicate that the Si-X bond is loathe to react by a one-electron transfer process; it is more difficult to add an extra electron to a Si-X bond than a C-X bond.¹¹⁵ Also, when reagents that are highly reactive toward substitution with alkyl halides through an exclusively free-radical pathway are employed (i.e., Cp(DPPE)FeMgBr), no reaction occurs with halosilanes.¹¹⁶⁻¹¹⁸

Scheme 8

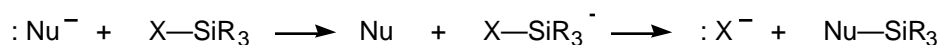

Many studies have been devoted to proving the formation of a pentacoordinate intermediate in the mechanism of nucleophilic displacement at silicon.⁴⁴ A true, carbon-like S_N2 mechanism would include backside attack of the nucleophile, a pentacoordinate transition state, inversion of stereochemistry at the silicon reaction center, and exhibit bimolecular reaction kinetics (Scheme 9, eq. a).⁹⁹ What is experimentally observed for silicon displacements, however, is either effectively complete inversion or retention of stereochemistry; and, consistent with formation of an intermediate involving both the nucleophile and the substrate in the rate determining step, bimolecular reaction kinetics are observed (Scheme 2.10, eq. b).⁵⁶ The difference is subtle: where carbon compounds form a pentacoordinate *transition state* (**20**), silicon compounds form a discrete pentacoordinate *reaction intermediate* (**121**). Thermodynamically, reactions at silicon typically have a very low activation energy ($\Delta H^\ddagger \approx 3$ kcal/mol) and a high entropy of activation ($\Delta S^\ddagger \approx -60$ e.u.), indicating an entropy-driven process with a highly organized transition state, such as that leading to a pentacoordinate intermediate.⁴⁴

Scheme 9

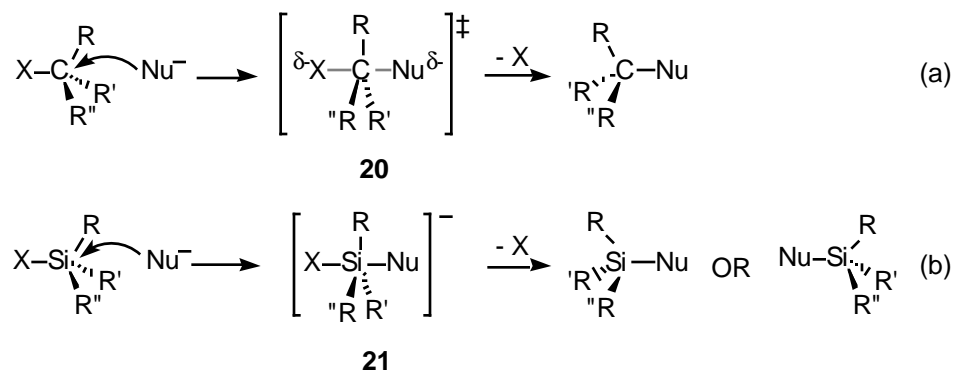

Kinetic studies consisting of comparison of the rate constants for displacements of pairs of leaving groups (i.e., X = Cl vs. OMe) leading to either exclusively inversion or exclusively retention showed the same rate of displacement, irrespective of the leaving group.¹¹⁹⁻¹²¹ In addition, no rate difference (deuterium isotope effect) was observed for the displacements of H and D. This data indicates that the rate determining step does not involve Si-X bond cleavage; thus, a single step S_N2 mechanism (Figure 4, (a)) is not occurring, but rather a two-step mechanism involving rate-determining formation of a discrete reaction intermediate (Figure 4, (b)).⁴⁴

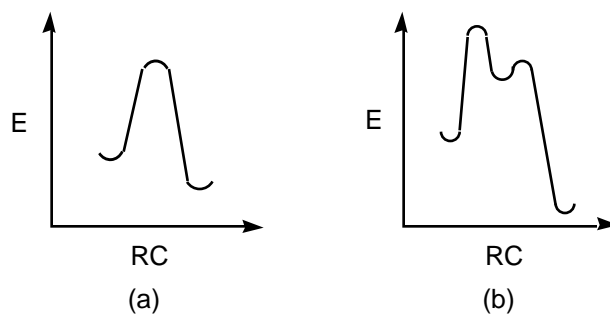
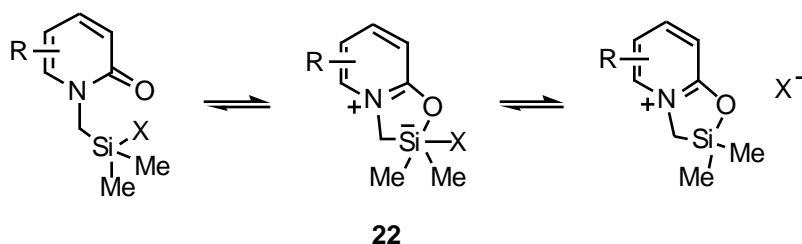

Figure 4. Reaction Coordinates for (a) Single-Step and (b) Two-Step Substitution Processes.

The intramolecular formation of pentacoordinate silicates by the capture of tetracoordinate silicon by a Lewis base, especially amines and amides, is an often-used device for the study of hypercoordinate silicates.^{42,122-126} Bassindale presented a cogent

argument for the formation of a pentacoordinate reaction intermediate by the intramolecular capture of a silane by a series of pyridones (Scheme 10).^{56,127-129} In addition to detecting the hypercoordinate intermediate **22** by ²⁹Si NMR, Bassindale showed that the equilibrium shifts to the right when (1) the pyridone substituent R becomes more electron-donating, causing oxygen to become more nucleophilic; and (2) the leaving group ability increases (OR < Cl < Br < OTf).

Scheme 10



Finally, the stereochemistry of nucleophilic displacement of chiral silanes has been extensively reviewed.^{44,56,130} When accompanied by kinetic data, the stereochemical outcome of nucleophilic displacements of silicon has provided great insight into the mechanism. Inversion of stereochemistry (Walden inversion) is a manifestation of S_N2 displacement at carbon. Most nucleophilic displacements at silicon also occur in a predictable manner; however the reaction takes place with either a high degree of configurational retention or inversion, as determined by the quality of the leaving group and the hardness of nucleophile. A more subtle influence on the stereochemistry of displacement is exacted by the steric bulk of the nucleophile, the hardness of the counter ion, and the configurational strain of the silane.

Inversion is believed to occur as a result of 180° backside attack, and generally occurs with soft nucleophiles; retention occurs as a result of 90° front-side (equatorial) attack, generally by hard nucleophiles (Figure 5). Front-side attack is possible with silanes because the Si-X bonds are significantly longer than the C-X bonds: a small, hard nucleophile can access the σ*_{Si-X} LUMO on silicon on the same side as the leaving group without enduring unfavorable orbital interactions with the leaving group. In contrast, soft

nucleophiles have larger, diffuse valence orbitals which cannot safely negotiate the front-side approach without experiencing a sizeable out-of-phase overlap with the leaving group. In all cases, the proposed mechanism includes participation of the hypercoordinate intermediate.

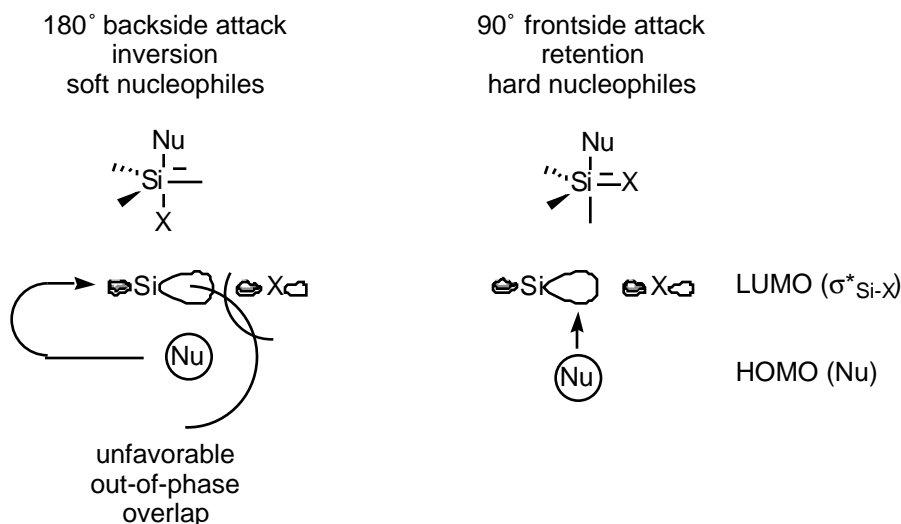

Figure 5. Angle of Attack by Nucleophiles on Silanes.

Fluoride Ion Activation of Silicon Bonds in Organic Synthesis

Synthetic chemists have exploited the unique reactivity of pentacoordinate silicates for nearly thirty years.⁴² the first example of a nucleophile-activated reaction of silanes was Corey's use of fluoride ion to remove silicon protecting groups.^{131,132}

Recognition of the heightened reactivity of hypercoordinate silicates has led to the development of novel chemistry, in particular the use of nucleophiles to activate the Si-O, Si-C, and Si-H bonds of tetracoordinate silane reagents *via* the presumed pentacoordinate reactive intermediate (**23**, Scheme 11).⁴² While employed less frequently for organic synthesis, this approach also has been used to activate Si-N and Si-M (M = Si, Ge, Sn) bonds.^{35,42,133}

Scheme 11

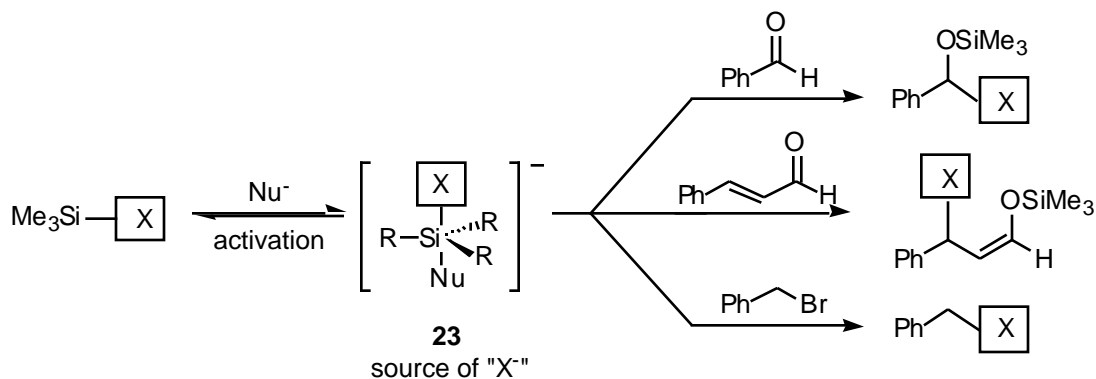

As described in detail above, addition of silaphilic catalysts such as fluoride ion to tetracoordinate silanes increases the reactivity and lability of Si-X bonds in the following manner:⁵⁶ relative to the tetracoordinate species, the pentacoordinate silicon center has an enhanced affinity for nucleophiles due to the increased positive charge on silicon and the lengthening of silicon-ligand bonds. In addition, expansion of coordination causes the ligands to become more nucleophilic due to the assumption of a significant negative charge, and the weakening of the bond to silicon. Both of these factors—the increased silicon Lewis acidity and ligand nucleophilicity upon extracoordination—have been exploited in organic synthesis.⁴²

A variety of silaphilic catalysts bearing nucleophilic O or N¹³⁴ have been employed for the activation of silanes,⁵⁶ most notably HMPA, Ph₃PO, RCO₂⁻, DMAP,²⁰ imidazole and *N*-alkyl imidazole derivatives, DMPU, NMP, DMF,¹³⁵ and DMSO.^{112,113,136} However, fluoride is the most often employed nucleophile for the cleavage of other Si-X bonds, because formation of the strong Si-F bond (582 kJ mol⁻¹)^{61,65} provides a powerful thermodynamic driving force toward reaction completion.⁴² Sources of fluoride ion include R₄N⁺ F⁻ (such as TBAF), KF/18-crown-6, KHF₂,¹³⁷ CsF, TAS-F (**8**),¹³⁸ and TBAT, (**1**)^{47,55} among others.^{47,48,138-146} Effective fluoride reagents are sources of “naked” and therefore highly nucleophilic fluoride by virtue of being unencumbered by a solvent cage and only weakly associated with the countercation.¹⁴⁷ As illustrated below, selection of the proper fluoride species is crucial to controlling the outcome of reactions of silicates.

Fluoride Activation of the Si-O Bond

Silyl ethers are ubiquitous to organic synthesis, in the form of protecting groups for alcohols and as silyl enol ethers.^{35,133,148,149} The development of orthogonally reactive silicon protecting groups is one of the greatest advances in modern synthetic organic chemistry; that said, silicon protecting group chemistry is a discipline unto itself, and is reviewed, elsewhere.^{35,133,148} Silyl enol ethers are also greatly valued for their synthetic utility: in the presence of an activator such as fluoride, silyl enol ethers function as enolate equivalents (Scheme 12), capable of delivering excellent regio- and stereoselectivity with a low incidence of self-condensation in the kinetically controlled aldol condensation. Enolates thus generated have been used most often for alkylation,¹⁵⁰⁻¹⁵³ cross-aldolization¹⁵³⁻¹⁵⁶ and Michael addition.¹⁵⁷⁻¹⁵⁹

Scheme 12

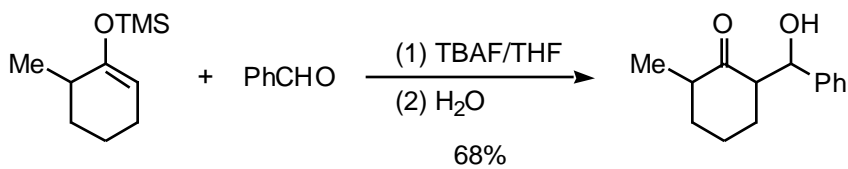

In the aldol reaction of silyl enol ethers, two general mechanisms are believed to occur, as dictated by the nucleophilicity of the fluoride source (Scheme 13); both involve formation of the pentacoordinate silicate **24** as the first step. The first mechanism occurs when weakly nucleophilic fluoride species are used, such as KF or CsF (eq. a). In this case, the weak fluoride nucleophile faces competition for coordination to the pentacoordinate silicon electrophile **24** from the Lewis basic oxygen of the substrate,¹⁶⁰⁻¹⁶² resulting in formation of hexacoordinate intermediate **25** and a chelation-like control of the reaction stereochemistry *via* a chairlike transition state. This accounts for the high degree of stereocontrol observed under weakly nucleophilic conditions.¹⁵⁹

Scheme 13

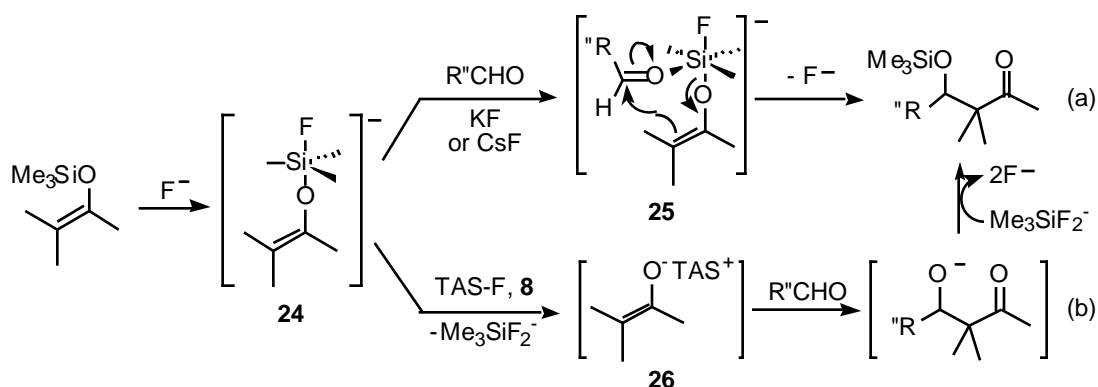

The second mechanism constitutes simple deprotection and formation of the free enolate; silicon does not participate in the critical carbon-carbon bond forming step (eq. b). In this case, a highly nucleophilic fluoride activator such as TAS-F (**8**) rapidly saturates the silicon center, displacing the free enolate **26** and generating $\text{Me}_3\text{SiF}_2^-$; because the process is catalytic in fluoride, this mode of reaction cannot be controlled stoichiometrically.^{152-155,158} The free enolate **26** thus generated is nucleophilic enough to react with primary alkyl halides (Scheme 14, eq. a).^{150,151} In contrast, the hypercoordinate silicate **25** generated upon activation by the weakly nucleophilic fluoride species CsF is not sufficiently reactive to achieve displacement (eq. b).^{42,152,153}

Scheme 14

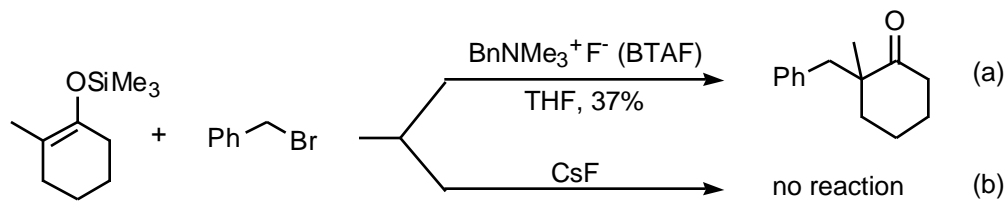

Lastly, the aldol reaction of the free enolate has a different stereochemical outcome from the silicon-centered process. As illustrated in Scheme 15, a predominantly *anti* geometry of the aldol products is observed regardless of the configuration of the starting silyl enol ether **27**; this is in congruence with the aldol reaction of free (non-metal chelated) enolates generated by other means under kinetically-controlled reaction conditions. In

addition, the diastereoselectivity of the reaction of the free enolate **28** is the same irrespective of the nature of the silyl group on the starting material.^{152-156,163,164}

Scheme 15

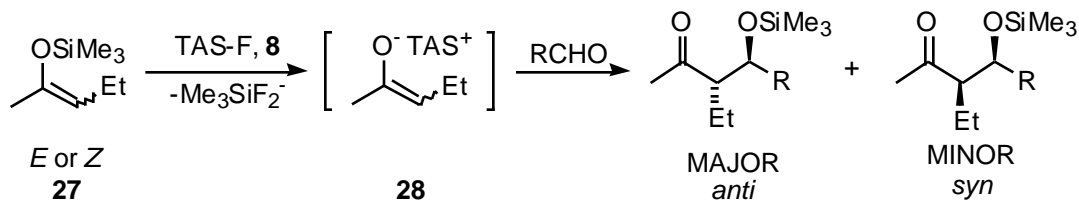

The stereoselectivity afforded by the fluoride-catalyzed aldol reaction of silyl enol ethers was recently exploited by Hosomi and co-workers in the TBAF-mediated stereoselective synthesis of 1,3-diols **30** and **31** from the dimethylsilyl enol ether derivatives of acyclic ketones **29** and aldehydes (Scheme 2.19).¹⁶⁵

Scheme 16

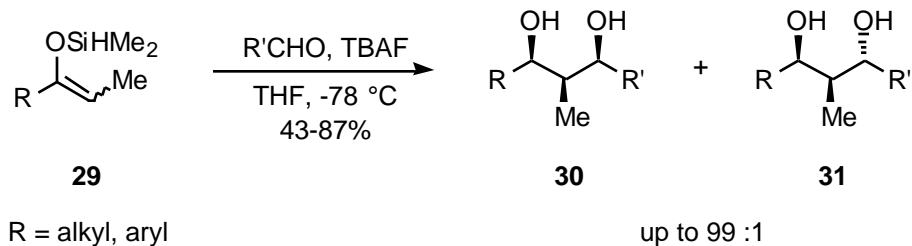

Ando and co-workers achieved the asymmetric aldol condensation of a series of alkyl and aryl silyl enol ethers **32** with benzaldehyde in the presence of chiral quaternary ammonium salts **33** derived from Cinchona alkaloids (Scheme 17).¹⁶⁶ Alcohols **34** were obtained in 46-78% yield with ee's as high as 62%.

Scheme 17

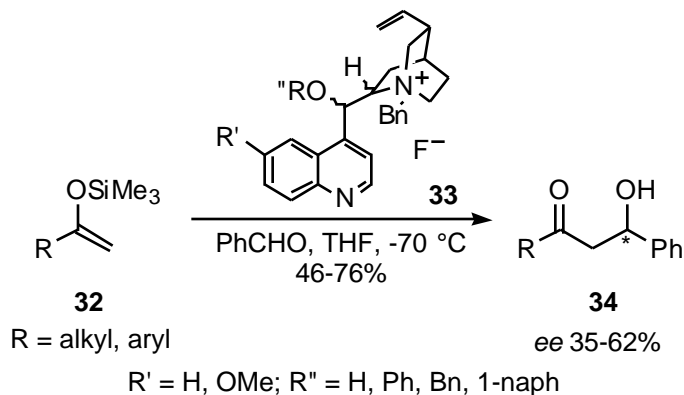

Fluoride Activation of the Si-H Bond

One of the most synthetically useful fluoride-mediated reactions of silanes is the reduction (hydrosilation) of carbonyl compounds with organosilicon hydrides (Scheme 18, eq. a); in addition, hydrosilanes effect the silylation of alcohols (eq. b).^{42,159} Fluoride ion was shown to be a particularly efficient catalyst^{167,168} under homogeneous (i.e., CsF in MeCN)¹⁶⁹ or heterogeneous (i.e., CsF, no solvent)^{170,171} conditions.

Scheme 18

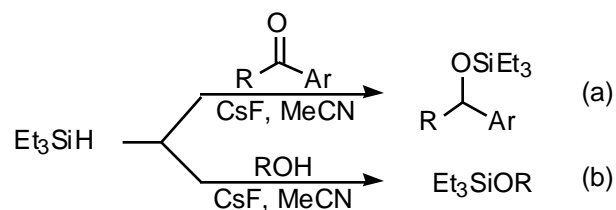

Like most nucleophile-catalyzed reactions of organosilicates, the reaction outcome can be rationalized by the initial formation of a pentacoordinate silicate **35** (Scheme 19).^{42,160} Subsequent coordination of the carbonyl or alcohol oxygen to the pentacoordinate silicon, followed by intramolecular hydride transfer achieves hydrosilation or formation of the silyl ether, respectively.⁴² Studies of isolable anionic silicates provides evidence for formation of the pentacoordinate intermediate **35**.⁴² Stable pentacoordinate hydrosilicates were shown to reduce a variety of carbonyl compounds in the absence of a nucleophilic catalyst, whereas the analogous tetracoordinate hydrosilanes were unreactive.¹⁷²

Scheme 19

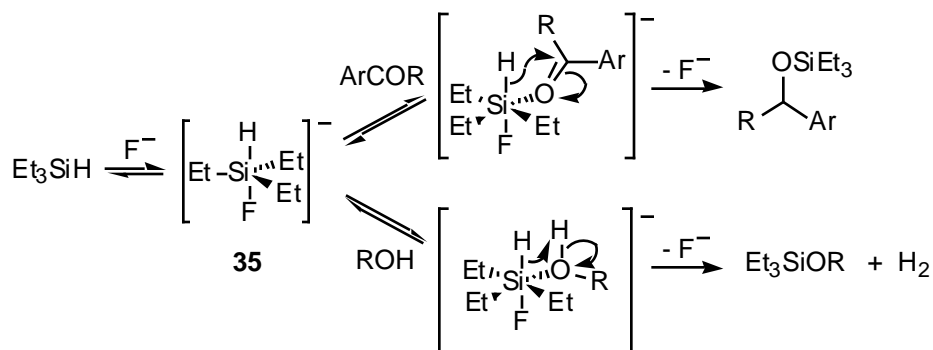

Generally the reduction process is stereoselective for the product as predicted by the Felkin-Anh model,^{173,174} and is independent of the nature of the fluoride ion.⁴² For example, chiral ketones **36** were reduced in good yield (83%) to give the *anti* alcohol **37** with de's as high as 98% (Scheme 20).¹⁷⁵

Scheme 20

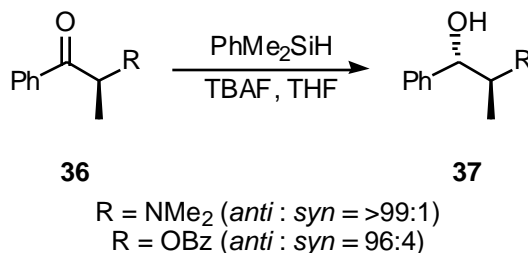

As with the fluoride-mediated reactions of silyl enol ethers, the stereochemical outcome of the hydrosilation of aldehydes and ketones supports the proposed mechanism (Scheme 21). For instance, the anti-Felkin-Anh stereoselectivity favoring formation of diol **39** in the intramolecular reduction of β -dimethylsiloxy ketones **38** can be explained by the influence of a chair-like intermediate on the facial selectivity of the reduction.¹⁷⁶

Scheme 21

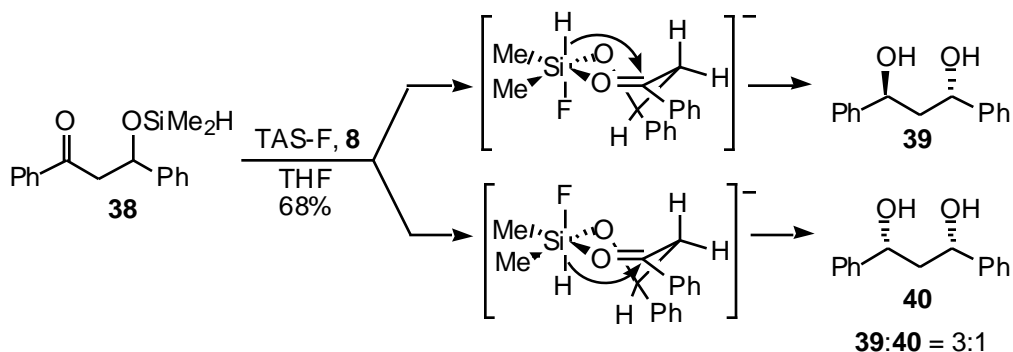

Fluoride Activation of the Si-C Bond

The fluoride-promoted desilylation of organosilicates containing the C-SiR₃ bond is a general method for C-C bond formation *via* the transfer to carbon electrophiles of allyl,¹⁷⁷ acyl,¹⁷⁸ alkynyl,^{179,180} propargyl,^{181,182} benzyl,^{183,184} oxiranyl,¹⁸⁵ and other stabilized carbanions.^{35,42,133,159} As described in the first chapter, organosilicates also participate in a

variety of interesting fluoride-promoted transition metal catalyzed C-C bond forming reactions; however, these are beyond the scope of this chapter.⁴² In particular, fluoride activation of the Si-allyl bond has been extensively used in organic synthesis for the allylation of aldehydes, ketones, and α,β -unsaturated compounds (Michael addition).⁵⁶ The regioselectivity of the addition reaction of trimethylallylsilanes (**42** and **43**) to aldehydes (**41**) is controlled by steric crowding and the electronic distribution at each allyl terminus, and mixtures of α - and γ -alkylated products (**44** and **45**, respectively) are observed (Scheme 22).¹⁷⁷ Isomeric trialkyl silanes **42** and **43** yield comparable α - and γ -alkylated product ratios (**44** : **45**).

Scheme 22

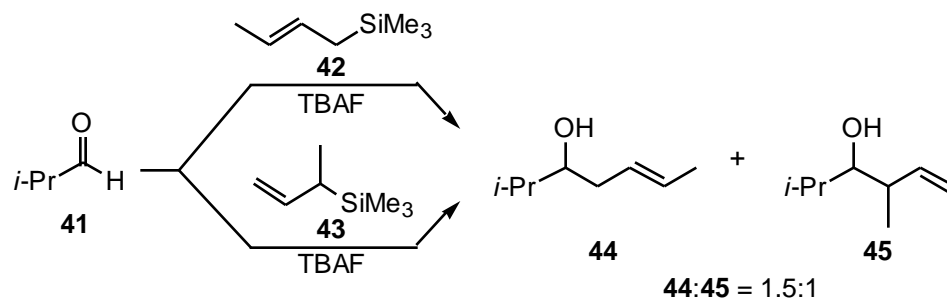

The observed regiochemistry is consistent with a mechanism involving generation of the free allyl anion.¹⁷⁷ However, formation of a truly “free” allyl anion is unlikely: the free allyl anion is basic enough to abstract a proton from the tetrabutylammonium cation of TBAF, yet no proton abstraction is observed.^{42,186} Neither extreme—a free anion or a silicate-based cyclic transition state—is plausible based on experimental observation. A hybrid of these two extremes has been proposed, wherein a non-basic hypercoordinate silicon complex **46** acts simply as an allyl transfer reagent, and the silicon center exerts no influence on the regiochemical outcome (Scheme 23).¹⁷⁷

Scheme 23

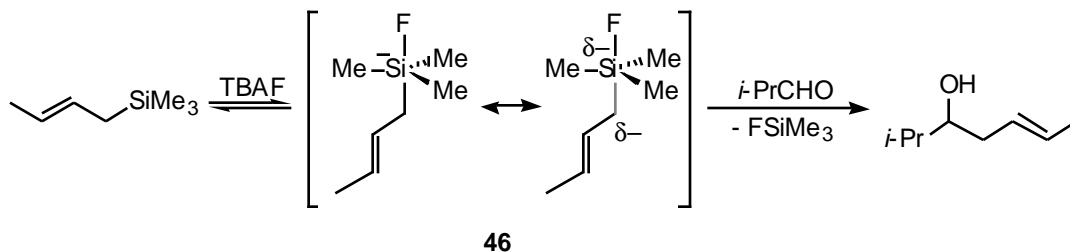

In contrast to the trimethylallylsilane analogs, the more Lewis acidic trifluoro- and trialkoxyallylsilanes more readily form a hexacoordinate intermediate.⁴² As with the reactions of silyl enol ethers, allylation takes place with a high degree of regio- and stereoselectivity as dictated by the nucleophilicity of the fluoride activator. Irrespective of the nature of the fluoride species, the mechanism begins with the formation of the pentacoordinate fluorosilicate **47** (Scheme 24). When an extremely nucleophilic fluoride donor (one that is reactive enough to cleave the relatively strong Si-C bond, such as phosphazanium fluoride, PZ^+F^-) is employed, fluoride rapidly attacks the pentacoordinate intermediate **47**, displacing a free allyl anion **49** and generating SiF_5^- (eq. b); as illustrated in the mechanism, 2 equiv of PZ^+F^- are required.¹⁸⁷ In agreement with the reactivity of free allyl anions generated by other means, the allyl anion released from the silicate reacts with primary alkyl halides.¹⁸⁷ When a less reactive fluoride source is employed (in this case TBAF is sufficiently weak), the substrate coordinates to pentacoordinate intermediate **47** (eq. a). A hexacoordinate species **48** is formed which ultimately controls the stereo- and regiochemical (exclusively γ -alkylation) outcome of the allylation by inducing a 6-membered cyclic transition state.⁴²

Scheme 24

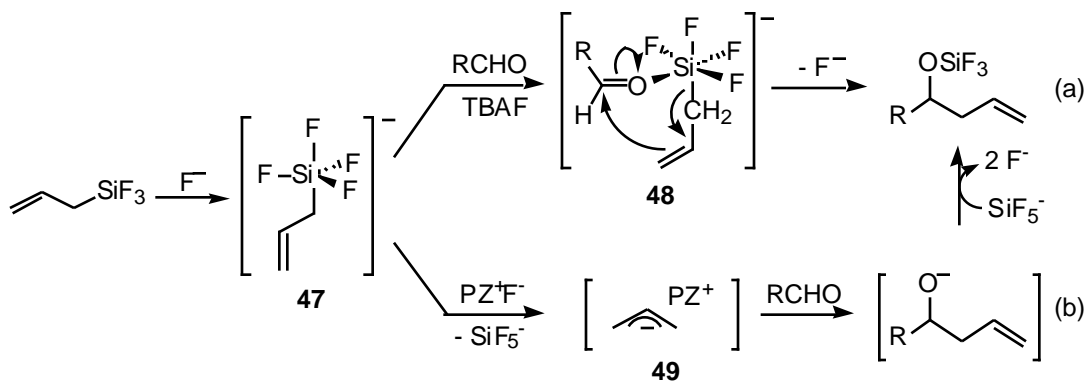

For example, a high degree of stereospecificity was observed for the CsF -induced addition of (*E*)- and (*Z*)-crotyltrifluorosilanes to aldehydes (Scheme 25): *erythro* isomers **54** were obtained from (*E*)-crotyltrifluorosilane **50**; and *threo* isomers **55** were obtained from (*Z*)-crotyltrifluorosilane **51**.¹⁸⁸ All yields were moderate to excellent (68-96%).

Scheme 25

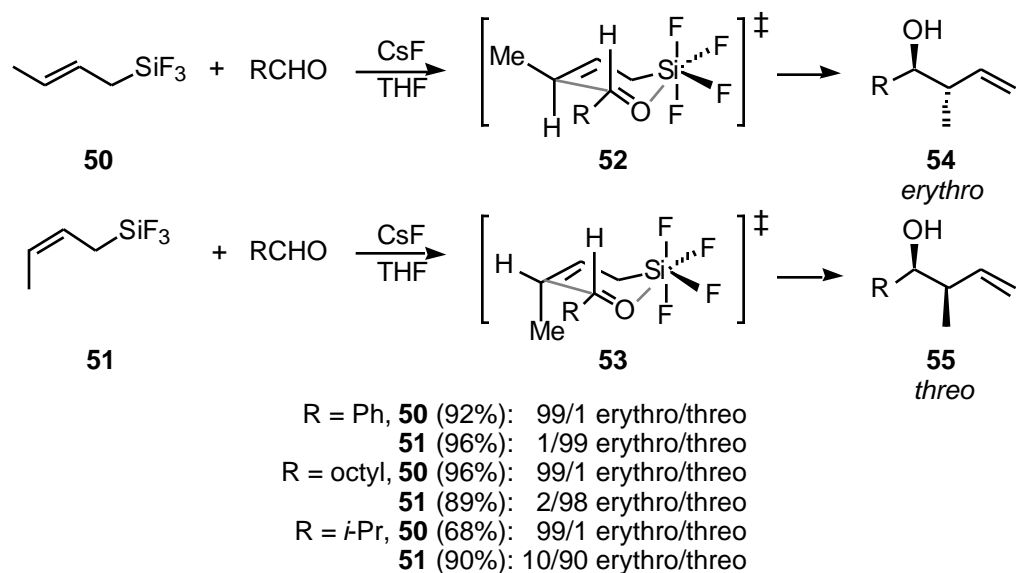

The use of fluoride for the activation of Si-X bonds (especially, X = H, O, and C) is an effective and well-studied synthetic strategy. Particularly noteworthy is the formation of C-C bonds with a high level of regio- and/or stereocontrol. Notoriously problematic nucleophiles, such as enolates, or carbon nucleophiles that can not be easily generated by other means (such as deprotonation) are accessible when delivered as the silicate.¹³³ To date, this approach has been exploited for the delivery of a wide range of nucleophiles with a reactivity that is markedly different from the free nucleophile, including the fluoride ion activation of Si-N and Si-M (M = Si, Ge, Sn) bonds.^{35,42,133} Ubiquitously, the experimentally observed difference in reactivity and product distribution between the silicate-delivered vs. the “free” nucleophile is rationalized by the formation of a hypercoordinate silicon reaction intermediate.

Results and Discussion

Background

Nucleophilic substitution is one of the most prized and useful transformations in the chemical arsenal. At the practical level, however, nucleophilic displacements often require relatively harsh reaction conditions with high reaction temperatures, polar solvents such as DMSO, HMPA or DMF, and a large excess of the nucleophile if high yields of product are to be achieved. Recently, the DeShong research group reported the use of tetrabutylammonium triphenyldifluorosilicate ($\text{Ph}_3\text{SiF}_2^- \text{Bu}_4\text{N}^+$, TBAT, **1**) as a source of nucleophilic fluoride for $\text{S}_{\text{N}}2$ displacement of primary and secondary alkyl substrates.⁴⁷ As illustrated in Scheme 26, TBAT is an excellent fluoride surrogate when compared to alkali metal fluorides or tetraalkylammonium fluorides because TBAT is relatively non-basic, as attested to by the reduced amount of elimination products. In addition, TBAT is a more practical reagent to handle, and store: TBAT is crystalline, soluble in a wide range of organic solvents, and is non-hygroscopic. The anhydrous nature of TBAT is its greatest advantage over other fluoride sources: the presence of hydroxide in traditional fluorinating reagents, from the reaction of fluoride anion and water, causes unwanted side reactions, most notably elimination or hydroxylation.

The displacement of a secondary tosylate is particularly illustrative (Scheme 26, eq. b): 98% yield of the desired fluoroalkane was achieved with TBAT (**1**, 6 equiv) in refluxing MeCN after 24 h; only 58% yield was obtained with TBAF (2 equiv) in THF at room temperature after 1 h, with the remaining yield being the alkene elimination products.^{48,55}

Scheme 26

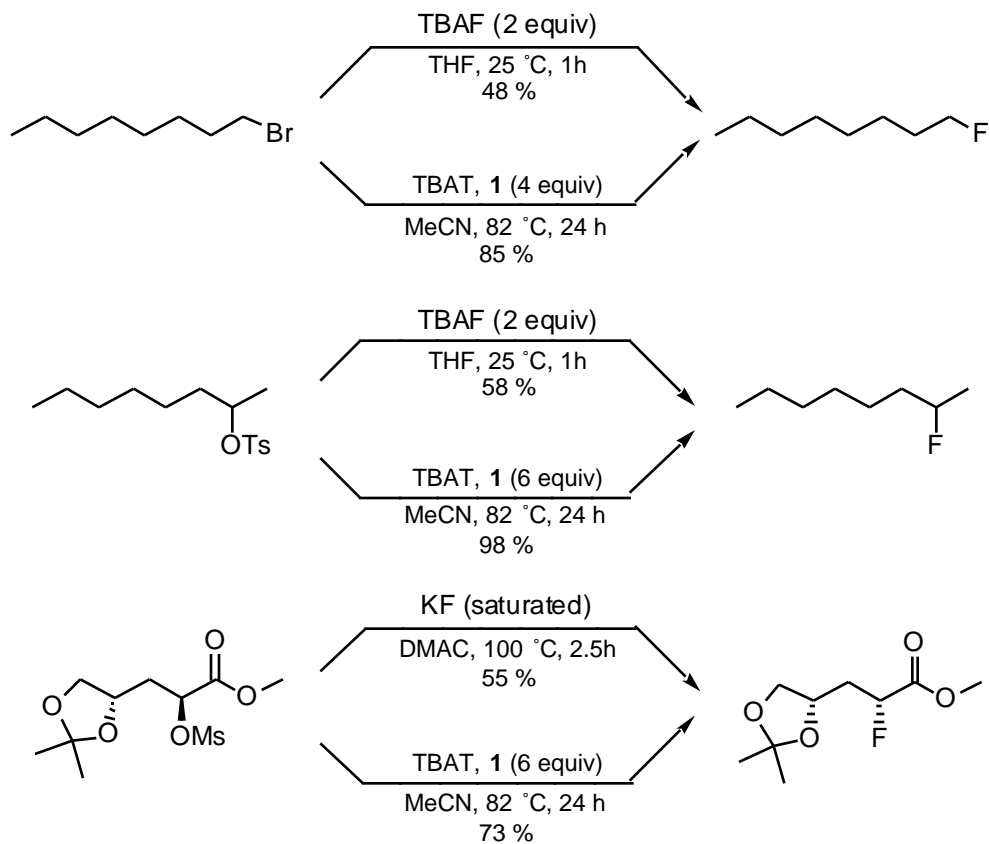

Admittedly, this technology does have some drawbacks. The fact that 4 to 6 equivalents of TBAT in MeCN are required to obtain reasonable reaction rates is wasteful and causes purification problems. These failings are partly ameliorated by the fact that unreacted TBAT can be precipitated and filtered from the reaction mixture and recycled. Also, subsequent optimization showed that excellent results are obtained with just two equivalents of TBAT in refluxing dioxane.⁵⁵

In an effort to enhance the reactivity of TBAT, Pilcher and Loezos studied the performance of a series of TBAT analogues, wherein the phenyl ligands were systematically replaced by methyl or fluoro substituents.^{55,189} The new fluorosilicates were tested in a standard displacement reaction (Table 5). The observed trend can be summarized as follows: as a strongly electron-withdrawing fluoride ligand of $\text{SiF}_5^- \text{Bu}_4\text{N}^+$ (**59**, entry 10) is replaced by a weaker EWG (phenyl), or a weak EDG (methyl), the

complex becomes more reactive. The increase in reactivity parallels the increase in the length of the Si-F bond, and the concomitant bond weakening.^{55,189}

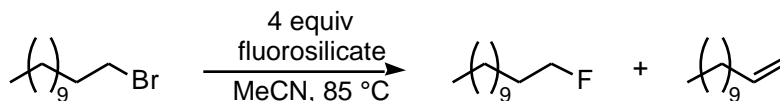

Entry #	Fluorosilicate	Time (h)	Fluoro %	Alkene %
1	(Me ₂ N) ₃ S ⁺ Me ₃ SiF ₂ ⁻ (TAS-F, 8)	0.5	40	60
2	Bu ₄ N ⁺ Me ₂ PhSiF ₂ ⁻ , 56	2	84	16
3	Bu ₄ N ⁺ Me ₂ SiF ₃ ⁻ , 57	5	85	15
4	Bu ₄ N ⁺ MePh ₂ SiF ₂ ⁻ , 58	6	92	8
5	Bu ₄ N ⁺ Ph ₃ SiF ₂ ⁻ (TBAT, 1)	24	85	15
6	Bu ₄ N ⁺ MePhSiF ₃ ⁻ , 59	24	22	11
7	Bu ₄ N ⁺ Ph ₂ SiF ₃ ⁻ , 60	24	22	7
8	Bu ₄ N ⁺ MeSiF ₄ ⁻ , 61	24	0	0
9	Bu ₄ N ⁺ PhSiF ₄ ⁻ , 62	24	0	0
10	Bu ₄ N ⁺ SiF ₅ ⁻ , 63	24	0	0

Table 5. Reactivity of a Series of Fluorosilicate Complexes in the Fluorination of 1-Bromododecane at 85 °C.^{55,189}

Although Bu₄N⁺ Me₂PhSiF₂⁻ (**56**), Bu₄N⁺ Me₂SiF₃⁻ (**57**), and Bu₄N⁺ MePh₂SiF₂⁻ (**58**) (Table 5, entries 2-4), offer a better reactivity profile than TBAT (**1**, entry 5), with shorter reaction times and comparable yields, TBAT remains the reagent of choice due a number of factors: (1) ease of handling and of synthesis from commercially available starting materials; and (2) the crystalline nature allows for the synthesis of a pure anhydrous reagent. TBAT is one of the few isolable solid silicates depicted in Table 5: simple exchange of methyl for phenyl not only impacts the reactivity of TBAT, but also greatly destabilizes the complex; even exchange of fluoro for phenyl yields a less stable silicate.^{55,189} Conveniently, once the tetracoordinate silane had been synthesized, the unstable TBAT analogs **56-58** were easily generated in situ by treatment with TBAF (Scheme 27, eqs. a-c); TBAT itself can be generated without isolation by treatment of Ph₃SiF (**2**) with TBAF (eq. d).

Scheme 27



Having demonstrated that hypercoordinate silicate derivatives are practical reagents for the delivery of fluoride anion,^{47,48,189} extension of this strategy to deliver other nucleophiles was investigated. The goal was to focus on developing a method in which the hypercoordinate silicon reagent is made *in situ* from either readily available or easily synthesized tetracoordinate silane starting materials. The attention focused on the use of substituted trimethylsilyl derivatives (Me_3SiX), many of which are commercially available (Scheme 28).

Scheme 28

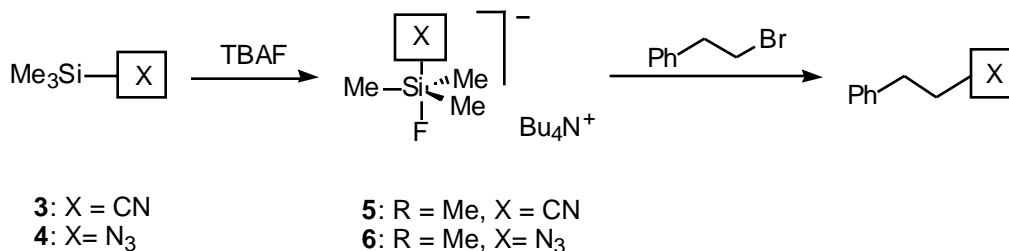

The initial experiments involved Me_3SiCN (**3**) and Me_3SiN_3 (**4**), the synthetic utility of cyanide and azide anion in nucleophilic displacements already being recognized.¹⁹⁰ Organonitriles are important synthetic intermediates for the preparation of nitrogen-containing compounds such as amines and amides, and are readily converted to carboxylic acids, esters, or aldehydes (Scheme 29). Because of the polarization of the carbon-nitrogen triple bond, nitriles undergo a variety of reactions with electrophiles on nitrogen and nucleophiles on carbon. In addition, the acidic α -proton can be removed by strong base.¹⁹⁰ The nitrile moiety itself is present in a number of pharmaceutically useful natural products, and in industrially important synthetic materials.¹⁹¹

Scheme 29

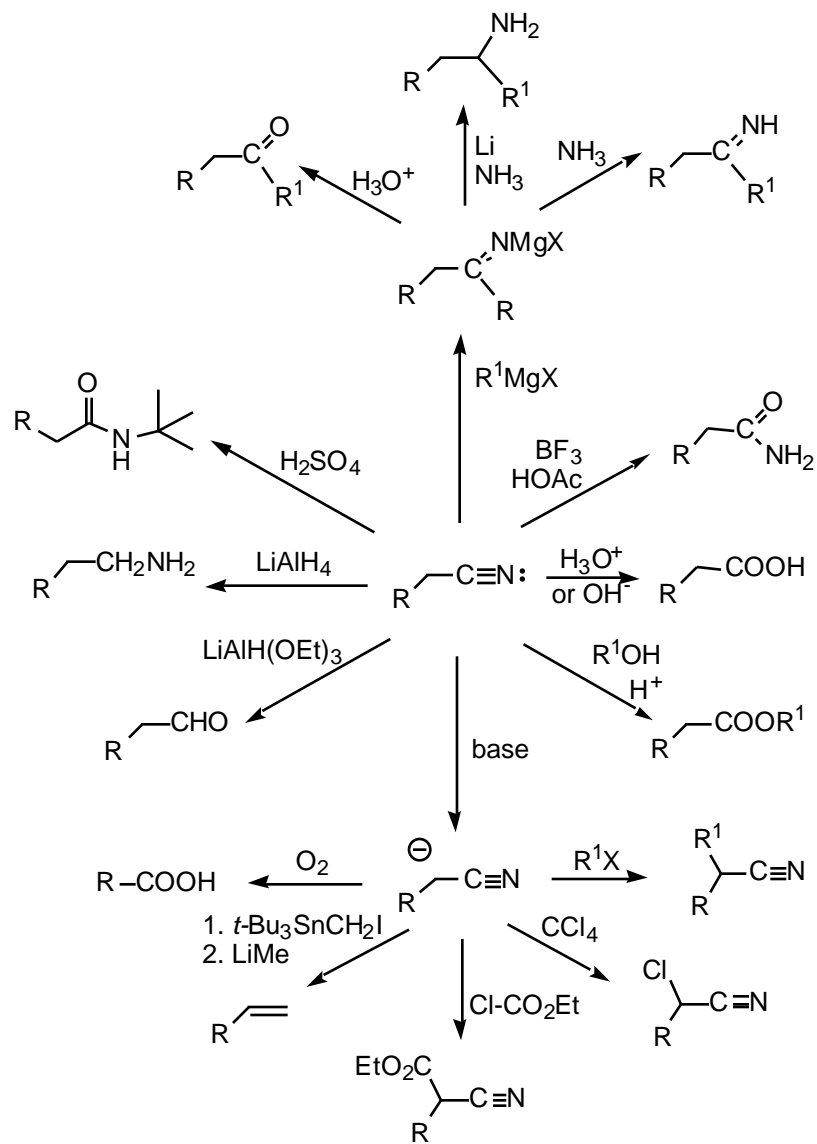

The DeShong group was interested in synthesizing glycosyl azide derivatives as precursors to *N*-linked or *N*-substituted glycoconjugates. The chemistry and biology of *N*-linked glycosides is a topic of intense interest due to the significant role that these compounds have in biological processes.¹⁹² Synthesis of the 1- or 6-glycosyl azide offers a facile route to the sugar amide (including glycoproteins), amine, or azanucleoside (Scheme 30).¹⁹⁰

Scheme 30

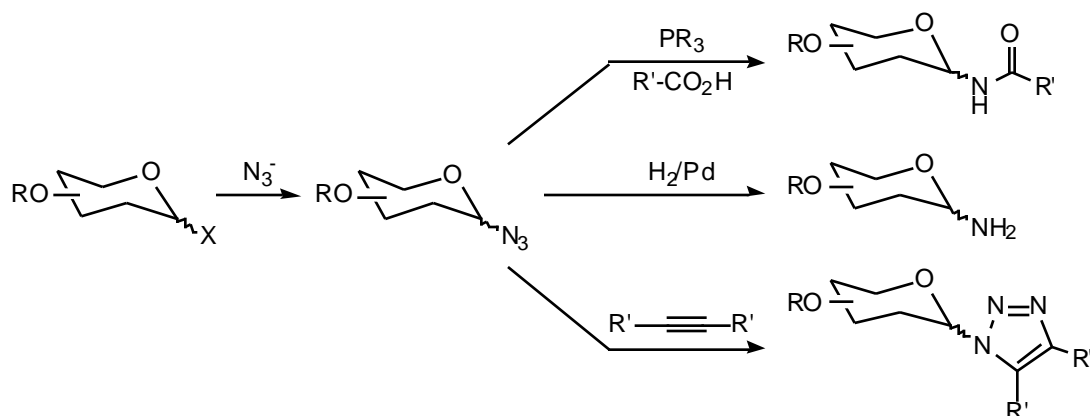

The most common method of introducing the nitrile or azide moiety is by nucleophilic displacement.^{190,193} Nucleophilic displacement is inherently regioselective and stereoselective, making this approach particularly valuable to the synthetic chemist. Alkali metal cyanide or azide has traditionally been used for this purpose; however, these reagents require vigorous reaction conditions, a large excess of the reagent, and long reaction times due in part to their limited solubility in organic solvents.¹⁹³ To overcome the poor solubility, phase transfer catalysts are typically employed,¹⁹⁴ most notably crown ethers,^{147,195,196} however, the high cost and relative toxicity¹⁹⁷⁻²⁰⁰ makes their use less attractive. Adsorption of alkali salts onto a solid support has been reported,²⁰¹⁻²⁰⁶ however the addition of water is required which limits the use of these reagents to hydrolytically stable substrates; in addition, lengthy reaction times were reported, due to poor reaction kinetics. Other methods employ toxic reagents or activating agents such as tin(IV)^{207,208} or

HMPA.²⁰⁹⁻²¹¹ Traditional alkali cyanide or azide displacement reactions require polar aprotic solvents, such as DMSO or DMF, which can be problematic to remove.

The more recently developed tetraalkylammonium salts are advantageous over their alkali metal salt analogs because they are soluble in THF and acetonitrile, and reactions are fast at or below room temperature.^{193,212} Unfortunately, along with displaying enhanced nucleophilicity relative to alkali metal salts, these reagents are also strongly basic, promoting elimination from the substrate. Another problem is that these salts are hygroscopic, or only available as the hydrate; dehydration often results in decomposition *via* attack of the nucleophile on the tetraalkylammonium cation (Scheme 31).¹⁴⁴ Water in the presence of the nucleophile generates hydroxide that may act as a nucleophile, forming unwanted hydroxy products in addition to the desired cyano- or azido products, or a base, forming elimination products.

Scheme 31

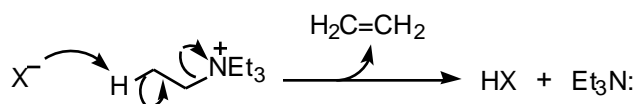

Initial experiments to determine the viability of using *in situ* generated silicates Me₃Si(CN)F⁻ Bu₄N⁺ (**5**) and Me₃Si(N₃)F⁻ Bu₄N⁺ (**6**) as sources of nucleophilic cyanide or azide, respectively, employed benzyl bromide (**64**) as the substrate, in order to avoid the possibility of elimination by-products (Scheme 32). The reaction conditions were analogous to those used for TBAT displacement reactions. Benzyl bromide (**60**) was treated with 2 equiv Me₃SiCN (**3**) or Me₃SiN₃ (**4**), and 2 equiv TBAF in acetonitrile and brought to reflux to generate the proposed reactive silicate intermediates **5** or **6**, respectively. In the case of Me₃SiCN, phenylacetonitrile (**65**) was formed quantitatively *in less than 5 min* (Scheme 32, eq. a); in the case of Me₃SiN₃, benzyl azide (**66**) was formed quantitatively in 8 h (eq. b). No reaction occurred in the absence of TBAF.

Scheme 32

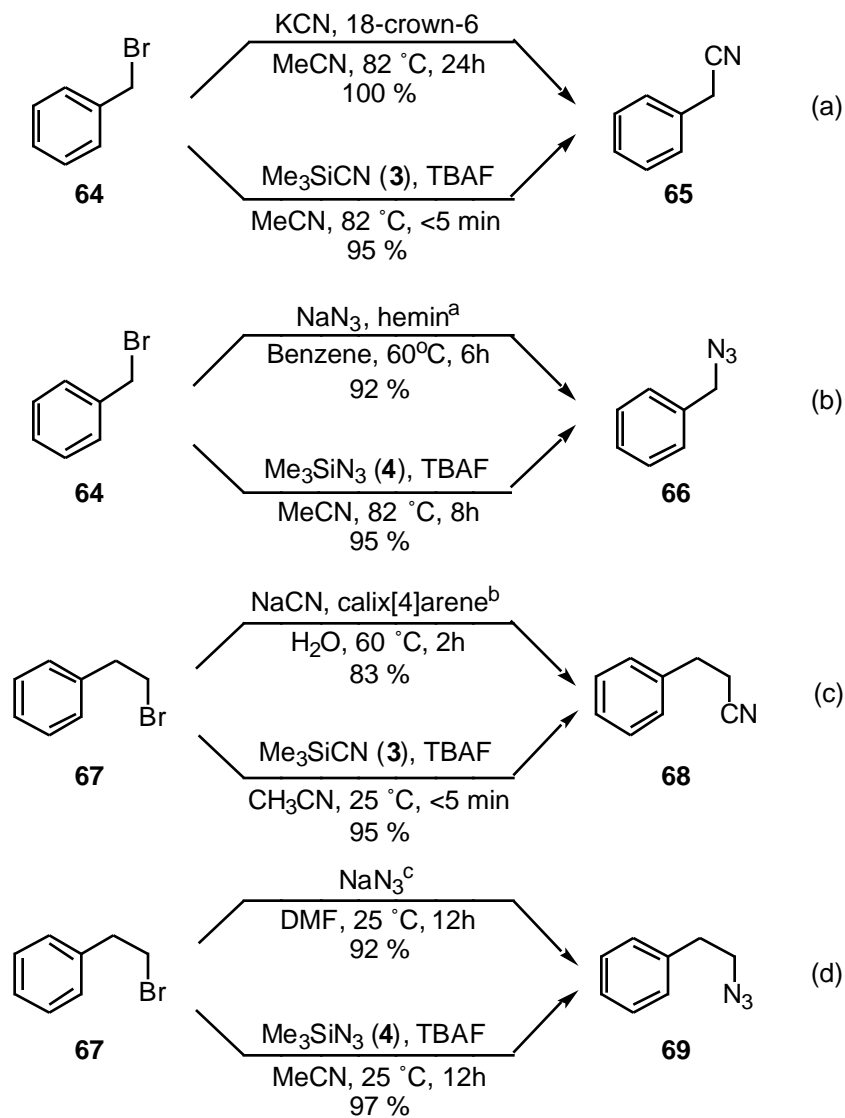

(a) Ref.²¹² (b) Ref.¹⁹⁴ (c) Ref.²¹³

In order to gauge the basicity of the reaction conditions, phenethyl bromide (**67**), which is prone to base-catalyzed elimination to afford styrene, was employed as the substrate (Scheme 32, eqs. c and d). Under identical reaction conditions, quantitative yields of the respective cyano-(**68**) and azido-(**69**) products were obtained. Comparison of the reaction conditions for nucleophilic displacement with those typically employed demonstrates the effectiveness of the silicate strategy. Displacements employing alkali

metal salts in polar solvents consistently required lengthy reaction times, and afforded more elimination products than the silicate method (*vide supra*), attesting to the relative non-basicity of the silicate methodology.

Concurrent with these studies, Takaya and co-workers published a preliminary report in which alkyl azide derivatives were prepared using the *in situ*-generated hypercoordinate azidosilicate **6**.²¹⁴ Having shown in our laboratories that the simple substrates depicted in Scheme 32 undergo facile cyanide and azide displacements using silicates **5** and **6**, the goal of the research described below was to determine the generality, and to optimize the reaction conditions for the use of silicate **5** as a source of nucleophilic cyanide. Soli, et al. from the DeShong research group extended the azide methodology to the synthesis of glycosyl azide derivatives.^{52,54}

Cyanide Displacements Utilizing Hypercoordinate Cyanosilicate 5

The major advantage of the silicate method with the substrates shown in Scheme 32 above was the rate of cyanide displacement in acetonitrile. The silicate-based displacements were extremely rapid, whereas the displacements using alkali metal salts of cyanide were sluggish (typically >12h)(Scheme 32, eqs. a and c). For example, the silicate-based displacement of benzyl bromide **64** occurred nearly instantaneously in refluxing acetonitrile, compared with the crown ether procedure that required 24 hours under identical conditions (eq. a). Results for the cyanide displacement with a variety of primary and secondary substrates bearing halide or sulfonate leaving groups are summarized in Table 6.

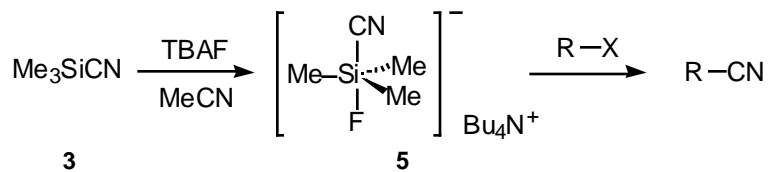

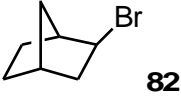
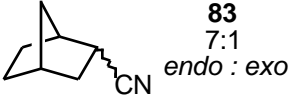
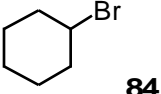
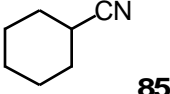
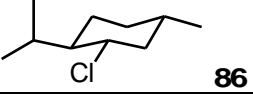
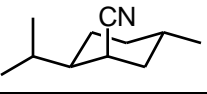
Entry	Substrate R-X	Product R-CN	Temp (°C)	Time (h)	Yield ^{a,b} (%)
1	(C ₆ H ₅)CH ₂ Br 64	(C ₆ H ₅)CH ₂ CN 65	82 25	0.1 1	95 (>95)
2	(C ₆ H ₅)CH ₂ Cl 70	(C ₆ H ₅)CH ₂ CN 65	82 25	2 72	(>95) (>95)
3	CH ₃ (CH ₂) ₁₁ I 71	CH ₃ (CH ₂) ₁₁ CN 72	82 25	0.1 6	95 (95)
4	CH ₃ (CH ₂) ₁₁ Br 73	CH ₃ (CH ₂) ₁₁ CN 72	82 25	2 36	95 (>95)
5	CH ₃ (CH ₂) ₁₁ Cl 74	CH ₃ (CH ₂) ₁₁ CN 72	82 25	3 96	95 (33) ^c
6	CH ₃ (CH ₂) ₁₁ OMs 75	CH ₃ (CH ₂) ₁₁ CN 72	82	0.1	95
7	(C ₆ H ₅)CH ₂ CH ₂ Br 67	(C ₆ H ₅)CH ₂ CH ₂ CN 68	82 25	0.1 32	95 (>95)
8	CH ₃ (CH ₂) ₅ CH(I)CH ₃ 76	CH ₃ (CH ₂) ₅ CH(CN)CH ₃ 77	82 25	1 72	(83) (68)
9	CH ₃ (CH ₂) ₅ CH(Br)CH ₃ 78	CH ₃ (CH ₂) ₅ CH(CN)CH ₃ 77	82 25	2 120	(82) (79)
10	CH ₃ (CH ₂) ₅ CH(OTs)CH ₃ 79	CH ₃ (CH ₂) ₅ CH(CN)CH ₃ 77	82 25	1 48	(76) (70)
11	(C ₆ H ₅)CH(Br)CH ₃ 80	(C ₆ H ₅)CH(CN)CH ₃ 81	82 25	1 5	92 (>95)
12	 82	 83 7:1 <i>endo</i> : <i>exo</i>	82 101 ^e	48 96	(0) ^d 70
13	 84	 85	82	48	(<5) ^f
14	 86	 87	82 101 ^e	48 96	(0) ^d (0) ^d

^a The indicated substrate, Me₃SiCN (**3**), and TBAF (1:1.5:1.5 molar ratio) in acetonitrile were allowed to react at the given temperature, unless otherwise noted. ^b Isolated yield after purification. The yield determined by G.C. analysis of the crude reaction mixture (vs. an internal standard) is reported in parentheses. ^c Reaction was stopped before completion. ^d No reaction was observed. ^e Reaction was performed in dioxane. ^f Starting material was consumed; remaining yield assumed to be cyclohexene.

Table 6. Reaction of Hypercoordinate Silicate **5** with Alkyl Halides.

Several features of the results in Table 6 are noteworthy. Although displacement was predictably longer for benzyl chloride (**70**, entry 2) than for the bromo analog (**64**, entry 1), the chloride underwent cyanide displacement in comparable yield. Previous methods, while achieving similar yield, required longer reaction times, painstakingly dried reagents, DMSO as the solvent, or toxic 18-crown-6 as a phase transfer catalyst.^{147,215,216} Primary alkyl iodide (**71**, entry 3), bromide (**73**, entry 4), chloride (**74**, entry 5), and mesylate (**75**, entry 6) were efficiently converted to the corresponding nitrile, where the relative order of reactivity was as follows: I \approx OMs > Br > Cl. Again, the yield of displacement product was comparable to traditional methodologies; however, these more conventional methods employed either high temperatures and lengthy reaction times, or required DMF as the solvent.^{203,212} Phenethyl bromide (**67**, entry 7) which should be more prone to elimination than the dodecyl substrates, gave no elimination products with silicate **5**, again attesting to the non-basic nature of the reagent. Predictably, secondary halides and sulfonates reacted slower with competing elimination lowering the yields of nitrile. For example, silicate **5** rapidly converted 2-iodooctane (**72**, entry 8), bromide (**74**, entry 9), and tosylate (**75**, entry 10), to the nitrile **73** in good yield (76-83%), although traces of the alkene by-product were also observed.

For secondary substrates, the silicate methodology was superior to prior methods with regard to both yield and ease of use. Regen and co-workers reported the displacement of the primary bromide in entry 4 (**73**, Table 6) in quantitative yield using NaCN-coated alumina in refluxing toluene for 24 hours.²⁰³ However, under the same conditions, Regen reported that secondary bromide **78** in entry 9 gave only 27% of the corresponding nitrile after 40 hours. The Bram group was able to perform the same transformation in 72% yield, but only under aqueous phase-transfer conditions.²¹⁷ Finally, secondary benzylic bromide **80** (entry 11) underwent smooth conversion to the corresponding nitrile upon treatment with cyanosilicate **5** without the formation of the elimination product. Again the yield was superior to that previously reported.²⁰¹

In refluxing acetonitrile, no appreciable amount of nitrile product formed from norbornyl bromide (**82**, Table 6, entry 12); however, in refluxing dioxane, displacement of the *exo* bromide occurred in good yield to give *endo* nitrile **83**, albeit sluggishly. This reaction occurred with predominantly inversion of configuration, supporting our proposed S_N2 mechanism for displacement at the carbon center. The ¹H NMR spectrum as well as the gas chromatograph of mixtures of *endo*- and *exo*-2-norbornane carbonitrile (**84**) were unresolved, and therefore could not be used for determining the *endo:exo* ratio.²¹⁸⁻²²⁰ Nor could the two products be separated by physical means. The ¹³C NMR spectrum of each stereoisomer has been reported previously. Fortunately, the ¹³C NMR spectrum of the mixture of stereoisomers is partially resolved at the C1, C6, and Cx (the nitrile carbon) signals. The *endo/exo* ratio was determined by integration of the ¹³C NMR spectrum: the relative areas of the carbon signals as shown above were: C6 (6.91:1.00), C1 (6.94:1.00), Cx (6.92:1.00), for an average *endo/exo* ratio of 6.92:1.00.

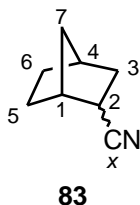

As expected, the cyclohexyl halides were poor substrates for the displacement reaction even with the silicate derivative. Cyclohexyl bromide (**84**, Table 6, entry 13) failed to give the displacement product, and gave the alkene instead, mirroring the results of previous researchers with more basic reagents.^{147,196,209} (-)-Menthyl chloride (**86**, entry 14), was similarly unreactive, presumably due to steric hindrance. However, it is noteworthy that the reagent did not induce elimination under these reaction conditions.

Cyanide is an ambident nucleophile and is known to react as a carbon nucleophile to give nitriles (R-CN), or as a nitrogen nucleophile to yield isocyanides (R-NC).²²¹ Traditionally, NaCN or KCN has been used to form nitriles, and AgCN has been used to form isocyanides.¹⁹⁰ It has been rationalized that alkali metal cyanide dissociates to give "free" cyanide ion which attacks with its more basic carbon terminus, whereas AgCN does

not entirely dissociate, leaving Ag^+ complexed to the carbon of the nucleophile, so that only nitrogen is available for nucleophilic attack.²²²

We hypothesized that the silicon could function analogously, so that C-complexation to silicon²²³ would leave the cyano nitrogen available to act as a nucleophile, as in Scheme 33. However, no traces of isonitrile products were detected in the reaction mixtures by ^{13}C -NMR or IR. In addition, isonitriles have a characteristic stench even at low concentration; no foul odor was detected in the crude product.

Scheme 33

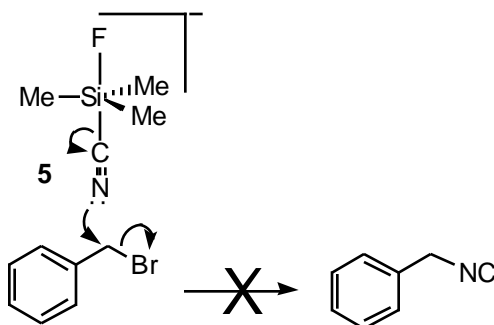

Exploration of the Use of Catalytic Amounts of Fluoride

Having shown that a stoichiometric amount of TBAF induces trimethylsilyl cyanide to transfer cyanide nucleophile to a variety of primary and secondary substrates, studies were initiated to explore if TBAF could be used catalytically. As shown in Table 7, it was found that the displacement of benzyl bromide is not catalytic in fluoride. More interestingly, the reaction is not even stoichiometric in TBAF: note that 1.0 equiv of TBAF relative to the substrate resulted in 89% conversion to the nitrile product. This is consistent with observations that when less than 1.2 equiv of TBAF to 1.2 equiv of Me_3SiCN (**3**) relative to 1.0 equiv of the substrate were employed, the reaction did not always go to completion. This is attributable to a number of factors, including: (1) hydrolysis of Me_3SiCN by the water present in commercial grade TBAF (5% H_2O), resulting in formation of Me_3SiOH ; and (2) the consumption of TBAF by reaction with the $\text{Me}_3\text{Si-F}$ by-product, resulting in the formation of $\text{Me}_3\text{SiF}_2^- \text{Bu}_4\text{N}^+$. As described below, NMR studies confirm the formation of both R_3SiOH and $\text{R}_3\text{SiF}_2^- \text{Bu}_4\text{N}^+$ in mixtures of R_3SiCN and TBAF.

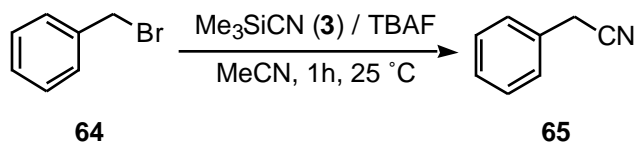

Entry	TBAF (mol %)	Yield ^{a,b,c} (%)
1	100	89
2	50	42
3	25	15

^a Benzyl bromide (**64**, 1 equiv), Me_3SiCN (**3**, 1.5 equiv), and the given amount of TBAF in MeCN were allowed to react at room temperature. ^b Reactions were complete by 1 h. ^c Yield of **65** determined by G.C. analysis of the crude reaction mixture (vs. an internal standard).

Table 7. Reaction of Benzyl Bromide (**64**) with Trimethylsilyl Cyanide (**3**) and Varying Amounts of TBAF.

As depicted in Scheme 34, in order for the reaction to be substoichiometric in TBAF, the leaving group anion $\text{Bu}_4\text{N}^+\text{Br}^-$ must itself become the activating catalyst by attacking Me_3SiCN to form a hypercoordinate bromo cyanosilicate reactive intermediate **88**. In effect, TBAF would act as an initiator, not as a catalyst. Fluoride catalysis is unlikely, because regeneration of fluoride would require the cleavage of the strong Si–F bond and formation of a much weaker Si–Br bond.

Scheme 34

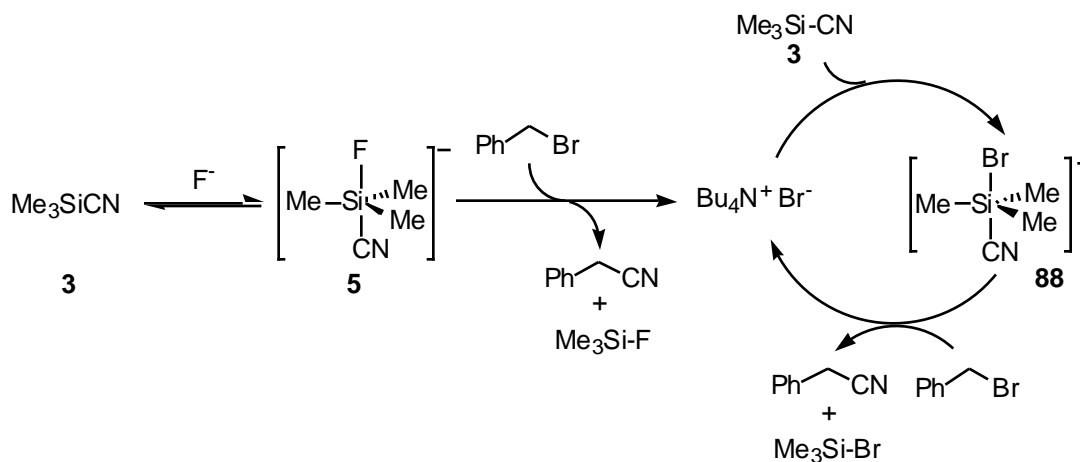

With the aim of testing the ability of bromide or other typical leaving group anions to activate Me_3SiCN , 1 equiv of benzyl bromide was treated with 1.5 equiv of Me_3SiCN and 1.5 equiv of a series of TBAX salts ($X = \text{Br}, \text{Cl}, \text{I}, \text{OTf}$). The results are depicted in Table 8. As anticipated, bromide, chloride, iodide and triflate ion (Table 8, entries 2-5) were not sufficiently nucleophilic to activate Me_3SiCN . When a more basic oxygen nucleophile was employed (tetrabutylammonium acetate, entry 6), phenylacetonitrile was formed, however the reaction conversion was poor. These results are explained by the relative Si–X and Si–O bond strengths, and indicate that there is a strong thermodynamic driving force behind the formation of the Si–F bond. The Si–F bond energy ($582 \text{ kJ}\cdot\text{mol}^{-1}$) is significantly greater than the Si–O, Si–Cl, Si–Br, or Si–I bond energies ($368, 391, 310,$ and $234 \text{ kJ}\cdot\text{mol}^{-1}$, respectively).

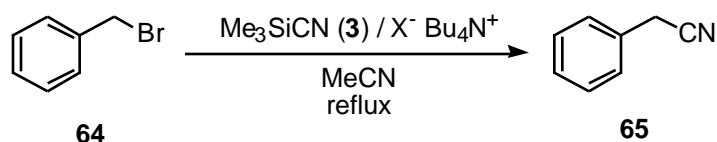

Entry	Nucleophile	Time (h)	Yield (%) ^{a,b}
1	F ⁻ Bu ₄ N ⁺	0.1	>95
2	Br ⁻ Bu ₄ N ⁺	24	0
3	Cl ⁻ Bu ₄ N ⁺	24	0
4	I ⁻ Bu ₄ N ⁺	24	0
5	TfO ⁻ Bu ₄ N ⁺	24	0
6	AcO ⁻ Bu ₄ N ⁺	0.1	45 ^c

^a Benzyl bromide (**64**) (1 equiv), Me_3SiCN (1.5 equiv), and the indicated nucleophile (1.5 equiv) in MeCN were allowed to react at reflux. ^b The yield of **65** was determined by G.C. analysis of the crude reaction mixture (vs. an internal standard). ^c Reaction was allowed to proceed for 24 h, but no additional progress was detected.

Table 8. Reaction of Benzyl Bromide (**64**) and Trimethylsilyl Cyanide (**3**) with Tetrabutylammonium Nucleophiles.

Investigation of Alternative Fluoride Sources

As illustrated in Table 8, fluoride is the unrivaled species for the activation of Me_3SiCN . In an effort to fully optimize this methodology, a number of other fluoride sources were surveyed in a standard displacement reaction. It was believed that the hydroxide contaminant in TBAF, and/or the inherent basicity of TBAF could contribute to the formation of elimination products, and that other less basic fluoride sources could reduce alkene formation. In addition, alkali metal salts of fluoride are significantly less expensive than TBAF. In order to test the ability of other common fluoride sources to activate Me_3SiCN , 1 equiv of benzyl bromide was treated with 1.5 equiv of Me_3SiCN and 1.5 equiv of a series of fluoride salts (KF, CsF, and TBAT, **1**). The order of fluoride reactivity toward the primary substrate was as follows: TBAF \approx TBAT \gg KF/18-crown-6 $>$ KF \approx CsF. Under heterogeneous conditions, the reaction was sluggish, and generally failed to go to completion (Table 9, entries 2 and 4). Addition of a phase transfer catalyst to KF increased the overall yield and shortened the reaction time (entry 3).

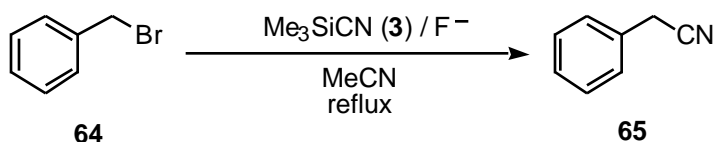

Entry	Fluoride Salt	Time (h)	Yield (%) ^{a,b}
1	$\text{Bu}_4\text{N}^+ \text{F}^-$	>1	100
2	KF	72	80 ^c
3	KF / 18-crown-6 ^d	48	100
4	CsF	48	75 ^c
5	TBAT, 1	>1	100

^a Benzyl bromide (**64**) (1.0 equiv), Me_3SiCN (**3**) (1.5 equiv), and the indicated fluoride salt (1.5 equiv) in MeCN were allowed to react at reflux. ^b The yield of **65** was determined by G.C. analysis of the crude reaction mixture (vs. an internal standard). ^c Reaction was allowed to proceed for an additional 24 hours, but no further progress was detected. ^d Catalytic in 18-crown-6 (20 mol %).

Table 9. Reaction of Benzyl Bromide (**64**) and Trimethylsilyl Cyanide (**3**) with Alternative Fluoride Sources.

TBAT and TBAF both rapidly induced the reaction (Table 9, entries 1 and 5). While both reagents performed similarly in the above displacement reaction with benzyl bromide, TBAT potentially could outperform TBAF in the reaction with secondary substrates. As described previously, TBAT is both less basic and more anhydrous than TBAF, and in theory should suppress elimination. However, effectively no reactivity difference was observed in the displacement of secondary alkyl substrates, regardless of the leaving group (Br, I, or OTs)(Table 10).

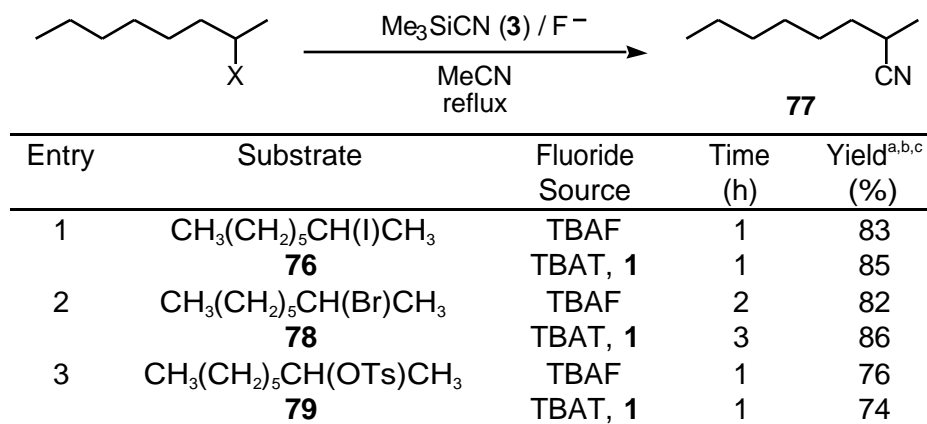

^a The yield of **77** was determined by G.C. analysis of the crude reaction mixture (vs. an internal standard). ^b All reactions went to completion; the remaining yield was 2-octene. ^c The remaining yield was 2-octene.

Table 10. Reaction of Secondary Alkyl Halides with Trimethylsilyl Cyanide (**3**) and TBAF or TBAT (**1**).

Proposed Mechanism

Two feasible mechanistic pathways for the Me₃SiCN/TBAF cyanide displacement reaction are depicted in Scheme 35. Based on standard silicate chemistry (*vide supra*), either path begins with attack of fluoride on silicon to form the hypercoordinate cyano fluorosilicate **5**. One potential mechanism subsequently involves direct transfer of cyanide from silicate **5**, without formation of a free cyanide nucleophile (route A). The second proposed mechanism entails the overall disproportionation of intermediate **5** to

tetrabutylammonium cyanide ($\text{Bu}_4\text{N}^+\text{CN}^-$, **90**) and Me_3SiF (**89**); $\text{Bu}_4\text{N}^+\text{CN}^-$ would then act as the cyanide source (route B).

Scheme 35

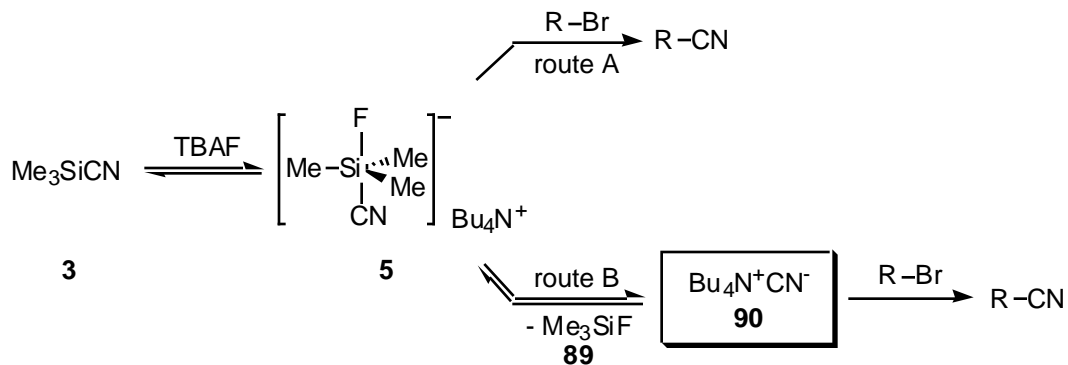

The cyanide anion delivered by silicate **5** should have a different reactivity than its disproportionation product, $\text{Bu}_4\text{N}^+\text{CN}^-$. In order to determine a reactivity difference, and to ultimately determine the reaction mechanism, commercially available $\text{Bu}_4\text{N}^+\text{CN}^-$ was purchased, and its reactivity compared to the $\text{Me}_3\text{SiCN/TBAF}$ reagent. The results are summarized in Table 11.

As seen in Table 11, $\text{Bu}_4\text{N}^+\text{CN}^-$ reacted 1.5 to 9 times faster than the cyanosilicate reagent **5** with a variety of primary and secondary alkyl halides and sulfonates to form the corresponding nitrile in good yield. The product yields were identical for both methods. As demonstrated by entries 1 through 4, the order of reactivity for both systems with primary alkyl halides was $\text{I} \approx \text{OTs} > \text{Br} > \text{Cl}$. In each case, $\text{Bu}_4\text{N}^+\text{CN}^-$ reacted more rapidly than the silicate system. Entry 3 is particularly illustrative: where the $\text{Me}_3\text{SiCN/TBAF}$ reaction only reached 33% conversion after 96 hours, the $\text{Bu}_4\text{N}^+\text{CN}^-$ reaction was complete within 36 hours. The secondary substrates in entries 5-8 showed a less dramatic difference in reaction time, and comparable product yields. Finally, norbornyl bromide (**82**, entry 9) was equally as unreactive with $\text{Bu}_4\text{N}^+\text{CN}^-$ as with $\text{Me}_3\text{SiCN/TBAF}$ in refluxing acetonitrile. In contrast, both the silicate and the $\text{Bu}_4\text{N}^+\text{CN}^-$ methods furnished norbornane carbonitrile (**83**) in refluxing dioxane.

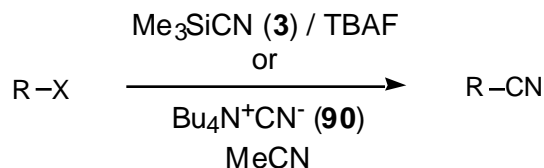

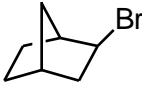
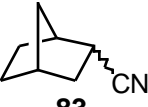
Entry	Substrate	Product	Reagent	Temp (°C)	Time (h)	Yield ^{a,b} (%)
1	CH ₃ (CH ₂) ₁₁ I 71	CH ₃ (CH ₂) ₁₁ CN 72	3/TBAF	25	6	95
			Bu ₄ N ⁺ CN ⁻	25	1	95
2	CH ₃ (CH ₂) ₁₁ Br 73	CH ₃ (CH ₂) ₁₁ CN 72	3/TBAF	25	36	>95
			Bu ₄ N ⁺ CN ⁻	25	3	>95
3	CH ₃ (CH ₂) ₁₁ Cl 74	CH ₃ (CH ₂) ₁₁ CN 72	3/TBAF	25	96	33 ^c
			Bu ₄ N ⁺ CN ⁻	25	36	>95
4	(C ₆ H ₅)CH ₂ CH ₂ Br 67	(C ₆ H ₅)CH ₂ CH ₂ CN 68	3/TBAF	25	32	>95
			Bu ₄ N ⁺ CN ⁻	25	2	>95
5	CH ₃ (CH ₂) ₅ CH(I)CH ₃ 76	CH ₃ (CH ₂) ₅ CH(CN)CH ₃ 77	3/TBAF	25	72	68
			Bu ₄ N ⁺ CN ⁻	25	24	71
6	CH ₃ (CH ₂) ₅ CH(Br)CH ₃ 78	CH ₃ (CH ₂) ₅ CH(CN)CH ₃ 77	3/TBAF	25	120	79
			Bu ₄ N ⁺ CN ⁻	25	96	77
7	CH ₃ (CH ₂) ₅ CH(OTs)CH ₃ 79	CH ₃ (CH ₂) ₅ CH(CN)CH ₃ 77	3/TBAF	25	48	70
			Bu ₄ N ⁺ CN ⁻	25	24	74
8	(C ₆ H ₅)CH(Br)CH ₃ 80	(C ₆ H ₅)CH(CN)CH ₃ 81	3/TBAF	25	5	>95
			Bu ₄ N ⁺ CN ⁻	25	3	>95
9	 82	 83 7:1 <i>endo</i> : <i>exo</i>	3/TBAF	82	48	0 ^d
				101 ^e	96	70
			Bu ₄ N ⁺ CN ⁻	82	48	0 ^d
				101 ^e	72	60

^a Where **3/TBAF** is the reagent, the indicated substrate, Me₃SiCN (**3**), and TBAF (1:1.5:1.5 molar ratio) in acetonitrile were allowed to react at the given temperature, unless otherwise noted. Where Bu₄N⁺CN⁻ (**90**) is the reagent, the indicated substrate, and Bu₄N⁺CN⁻ (1:1.5 molar ratio) in acetonitrile were allowed to react at the given temperature. ^b Yield determined by G.C. analysis of the crude reaction mixture (vs. an internal standard). ^c Reaction was stopped before completion. ^d No reaction was observed. ^e Reaction was performed in dioxane.

Table 11. Comparison of Nitrile Synthesis Using Me₃SiCN/TBAF or Bu₄N⁺CN⁻.

The observed reactivity difference between the two methods suggests that the displacement reaction does not involve a simple disproportionation of cyanosilicate **5** to form $\text{Bu}_4\text{N}^+\text{CN}^-$ (**90**) *in situ* (Scheme 36, eq. a).

Scheme 36

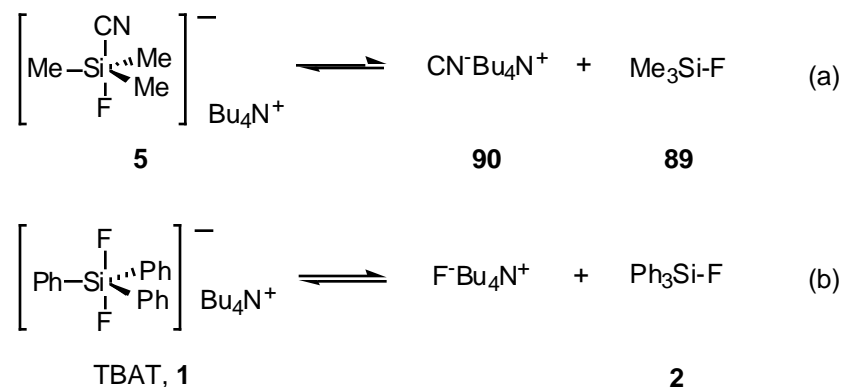

Prior research with the analogous fluorosilicate TBAT (**1**) mirrors these results. Experimental evidence supported the conclusion that TBAT does not simply disproportionate to generate TBAF *in situ* (Scheme 36 above, eq. b), but rather directly delivers a softer, less basic fluoride nucleophile. For example, Pilcher demonstrated that the hypercoordinate fluorosilicate TBAT performed fluoride displacements more slowly, and gave less elimination than its disproportionation product, TBAF (Scheme 37).^{48,55}

Scheme 37

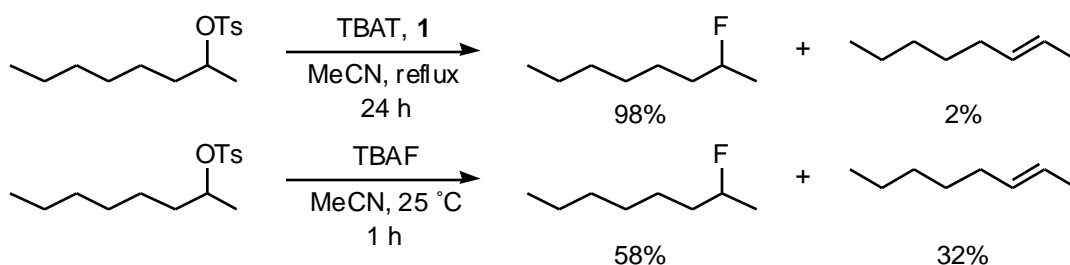

Having determined that $\text{Bu}_4\text{N}^+\text{CN}^-$ was not the reactive intermediate, investigations into a mechanism involving hypercoordinate cyanosilicate **5** as the direct source of cyanide were undertaken. In addition, the participation of other silicon species such as dicyano trimethylsilicate (**91**), or difluoro trimethylsilicate (**92**) was investigated.

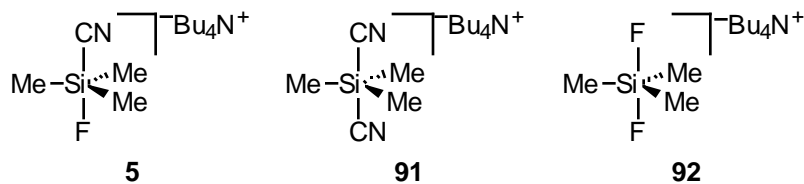

Chris Handy of the DeShong group endeavored to obtain spectroscopic evidence supporting the existence of hypercoordinate cyanosilicate intermediates such as **5**, **91** and **92**.²²⁴ Triphenylsilyl cyanide (Ph_3SiCN , **93**, Scheme 38) was chosen for study rather than trimethylsilyl cyanide (**3**): given that hypercoordinate silicates are inductively stabilized by aryl substituents (*vide supra*), it was expected that upon treatment with 1 equiv of TBAF, a greater amount of the more stable hypercoordinate intermediate **94** would form (Scheme 38). Also, in contrast to the non-isolable trimethylsilyl silicates **91** and **92**, authentic samples of the triphenylsilyl silicate analogs (**95** and **1**, respectively) were readily prepared and characterized.

Scheme 38

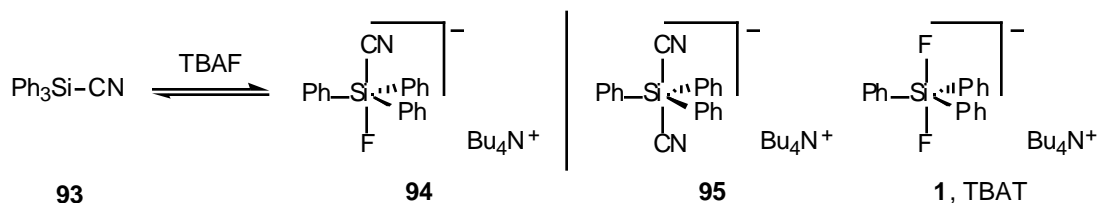

For reference, Table 12 summarizes the ^{29}Si NMR spectral data for all authentic samples prepared by Handy. It was expected that any four- or five-coordinate silicate species formed in the reaction would be detected the ranges 45 to -115 ppm or -70 to -200 ppm, respectively (*vide infra*).⁹³

Compound	²⁹ Si (ppm)	J _{Si-F} (Hz)
Ph ₃ SiCN, 93	-28.2, s ^b	-
Ph ₃ SiF, 2	-4.0, d	282
[Ph ₃ SiF ₂][NBu ₄] ⁺ , 1	-106.3, t	251
[Ph ₃ Si(CN) ₂][NBu ₄] ⁺ , 95	-118.0	-
Ph ₃ SiOH, 96	-16.9, s	-
Ph ₃ Si-O-SiPh ₃ , 97	-18.2, s	-

^a Value for the phenyl carbon directly attached to silicon. ^b Spectrum in THF. ^c Value for the nitrile carbon.

Table 12. ²⁹Si-NMR Spectral Data for Authentic Samples Used In Mechanistic Studies (Room Temperature, CDCl₃).^{47-49,55}

Treatment of Ph₃SiCN (**93**) with 1 equiv of TBAF led to the immediate disappearance of the starting material signal and formation of hydrolyzed silane [Ph₃SiOH (**96**) and its ether Ph₃SiOSiPh₃ (**97**)]; at room temperature, no other peaks were observed in the ²⁹Si NMR spectrum (Figure 6, spectrum b). The silicon hydrosylates **96** and **97** can be attributed to the reaction of the water present in TBAF with the starting silane **93** and/or silicate derivatives **94** and **95**. Handy conclusively demonstrated that the source of these silicon hydrosylates was likely to be cyano fluorosilicate **94** and/or dicyanosilicate **95**. Treatment of Ph₃SiCN (**93**) with water did not result in formation of either silanol **96** or its silyl ether **97**. In contrast, an authentic sample of dicyanosilicate **95** underwent immediate conversion to hydrolyzed silanes **96** and **97**. It was concluded that silicate formation was a prerequisite for the hydrolysis process.

In order to probe the existence of a rapid equilibrium, Handy performed the same NMR experiment at -30°C. As before, treatment of Ph₃SiCN (**93**) with 1 equiv of TBAF led to the disappearance of the starting material signal and formation of hydrolyzed silane; however at reduced temperature, a peak corresponding to Ph₃SiF₂⁻ (TBAT, **1**) also was observed (Figure 6, spectrum c). In the ¹³C NMR spectrum, neither Bu₄N⁺CN⁻ (**90**) nor the

starting materials Ph_3SiCN (**93**) and TBAF were observed at any temperature, implying the rapid and possibly irreversible formation of intermediate **94** at the reaction outset.

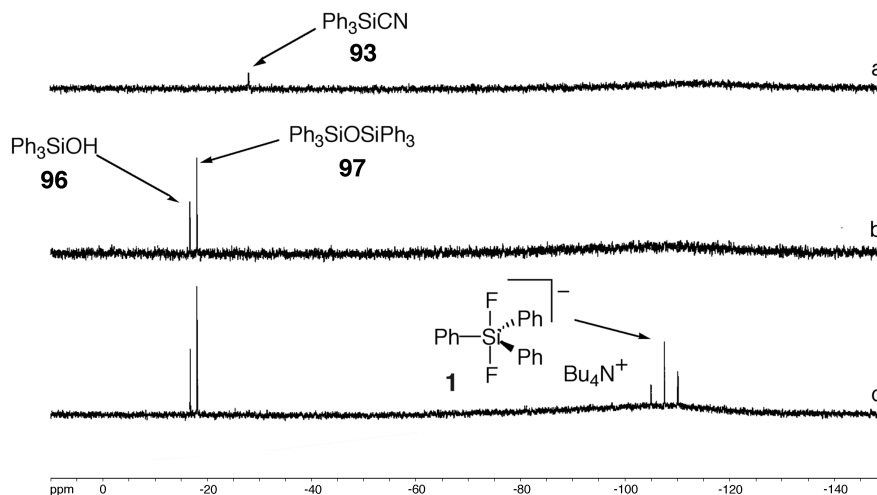
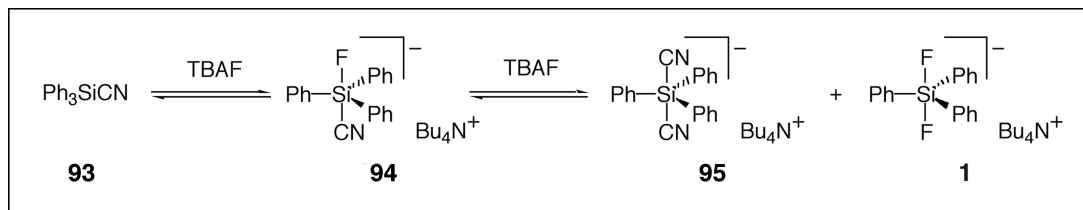

^{29}Si spectrum with inverse gated proton decoupling, recorded at 99 MHz on a Bruker AMX 500 spectrometer ($D_1 = 10$ sec, $P_1 = 9.00$ μsec , no spinning). a: Ph_3SiCN (**93**) in THF, 25 $^\circ\text{C}$, 98 scans; b: Ph_3SiCN (**93**) + 1 equiv TBAF in THF, 25 $^\circ\text{C}$, 250 scans; c: Ph_3SiCN (**93**) + 1 equiv TBAF in THF, -30 $^\circ\text{C}$, 400 scans. The broad peak appearing in the range -90 to -120 ppm in all ^{29}Si spectra is present in all samples including solvent blanks, and is likely due to the use of silicon-based adhesives in the assembly of the probe. (Reprinted by permission of C. J. Handy)

Figure 6. Triphenylsilyl Cyanide (**93**) and TBAF (1 equiv), ^{29}Si Spectrum.

Formation of TBAT in 1:1 mixtures of Ph_3SiCN and TBAF, *without the formation of $\text{Bu}_4\text{N}^+ \text{CN}^-$ or Ph_3SiF* would imply a mechanism involving disproportionation of two molecules of the hypercoordinate cyano fluorosilicate **94** to dicyanosilicate **95** and TBAT (**1**) (Scheme 39). The absence of signals corresponding to a number of silicates, most especially the key intermediates cyano fluorosilicate **94** and dicyanosilicate **95**, does not disprove their existence, but rather suggests that these hypercoordinate silicates are significantly less stable than TBAT, and may exist fleetingly or undergo rapid hydrolysis

to the silanol Ph_3SiOH (**91**). Ultimately, the process is driven at least in part by formation of the highly stable difluorosilicate **1**. In addition, the fact that dicyanosilicate **90** can be prepared and observed by IR and NMR spectroscopy, whereas the mixed cyano fluorosilicate **94** cannot suggests that the equilibrium is further driven by formation of symmetrical dicyanosilicate **95**.

Scheme 39

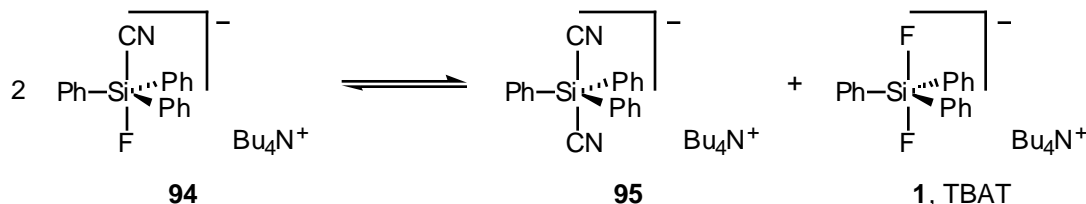

In summary, no direct evidence of production of hypercoordinate intermediate **94** was provided by the NMR studies performed by Handy, however the spectroscopic data strongly points away from a simple *in situ* generation of $\text{Bu}_4\text{N}^+\text{CN}^-$. The NMR study indirectly points to a process involving rapid disproportionation of unstable cyano fluorosilicate intermediate **94** to the more stable dicyano and difluoro silicates (**95** and **1**, respectively, Scheme 39, above). In theory when this reaction is performed in the presence of a displacement substrate, either hypercoordinate cyanosilicate **94** or **95** could function as the source of nucleophilic cyanide (Scheme 40). However the disproportionation of **94** to dicyanosilicate **95** and TBAT is very rapid by NMR spectroscopy, in contrast to the rate of displacement of alkyl halides. Thus, silicate **95** is strongly implicated as the reactive intermediate in this process.

Scheme 40

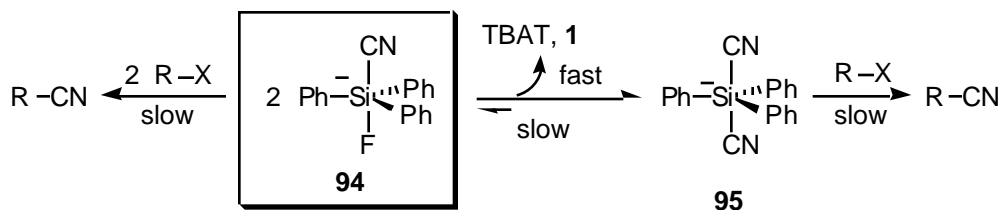

Scheme 41 depicts a plausible mechanism for the $\text{Me}_3\text{SiCN}/\text{TBAF}$ displacement reaction that takes into account the following conclusions based on the NMR data, experimental observations, and literature precedence: (1) the mechanism involves as its first step the transient formation of the hypercoordinate cyano fluorosilicate **5** followed by rapid disproportionation to dicyanosilicate $\text{Me}_3\text{Si}(\text{CN})_2^- \text{Bu}_4\text{N}^+$ (**91**) and $\text{Me}_3\text{SiF}_2^- \text{Bu}_4\text{N}^+$ (**92**); (2) $\text{Bu}_4\text{N}^+\text{CN}^-$ (**90**) at no time is generated in significant quantity; (3) TBAF is rapidly consumed at the reaction outset; (4) the leaving group nucleophile does not participate in the reaction sequence; and (5) only slightly more than 1 equiv of the $\text{Me}_3\text{SiCN}/\text{TBAF}$ mixture is required for reaction completion, most likely due to water contamination.

Scheme 41

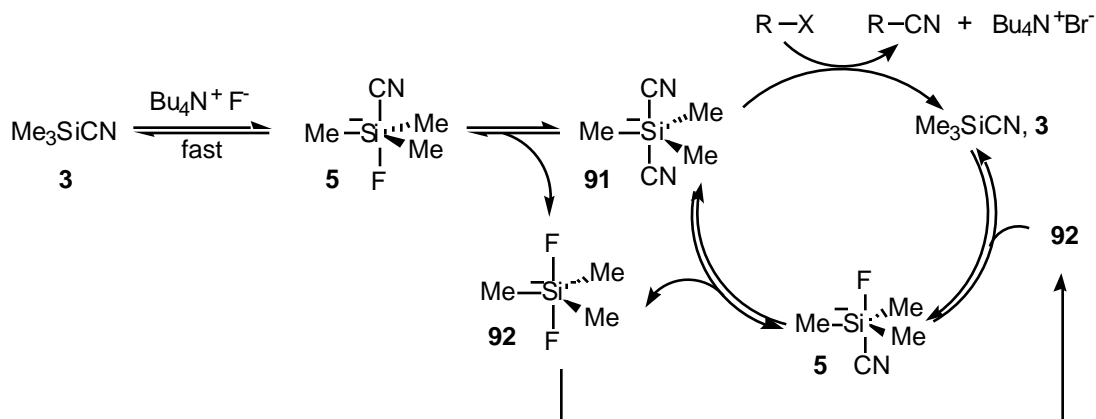

The above proposed mechanism begins with rapid formation and disproportionation of cyano fluorosilicate intermediate **5** to generate $\text{Me}_3\text{SiF}_2^-$ (**92**) and dicyanosilicate **91**. Hypercoordinate silicate **91** transfers cyanide nucleophile to the substrate to form alkylnitrile, and to regenerate Me_3SiCN (**3**). The Me_3SiCN thus produced undergoes rapid fluoride activation by $\text{Me}_3\text{SiF}_2^-$ (**92**) to form a second molecule of cyano fluorosilicate **5**, which again disproportionates to $\text{Me}_3\text{SiF}_2^-$ (**92**) and a second molecule of dicyanosilicate **91**. A notable feature of the above proposed mechanism is $\text{Me}_3\text{SiF}_2^-$ (**92**) is required to function as a fluoride source; otherwise 2 equiv of TBAF to 1 equiv of Me_3SiCN would be required for reaction completion. Silicate $\text{Me}_3\text{SiF}_2^- \text{Bu}_4\text{N}^+$ (**92**) should be an excellent fluorinating species in analogy to the powerful fluorinating reagent $\text{Me}_3\text{SiF}_2^- (\text{Me}_3\text{N})\text{S}^+$ (TAS-F, **8**).



Conclusions

Treatment of trimethylsilyl cyanide with TBAF resulted in the *in situ* generation of a hypercoordinate cyanosilicate. The reactive silicate has been shown to be highly effective as a nucleophilic cyanide donor under extremely mild conditions in contrast to traditional cyanide reagents. Primary and secondary alkyl halides and sulfonates undergo rapid and efficient cyanide displacement in the absence of phase transfer catalysts with the silicate methodology. The Me₃SiCN/TBAF system is significantly less reactive and less basic than TBA-CN, therefore the mechanism of reaction most likely involves the *in situ* generation of a hypercoordinate cyanosilicate, rather than disproportionation of Me₃SiCN and TBAF to form TBA-CN *in situ*.

Epilogue

Since the publication of the above method for azide and cyanide displacements *via* hypercoordinate silicate intermediates in 1999,⁵²⁻⁵⁴ a number of papers have appeared in the literature²²⁵ which report using our technique, primarily for the stereocontrolled synthesis of azido sugars,²²⁶⁻²³³ and for the nucleophilic ring opening of aziridines.^{227,234} Hou reported the ring-opening reactions of aziridines **98** with trimethylsilyl compounds triggered by TBAF to give the corresponding products **99** and **100** regioselectively in excellent yield (Scheme 42).²³⁴ TBAF functions to simply initiate the reaction: the amide leaving group is itself nucleophilic enough to attack silicon, and cleave the Me₃SiX bond.

Scheme 42

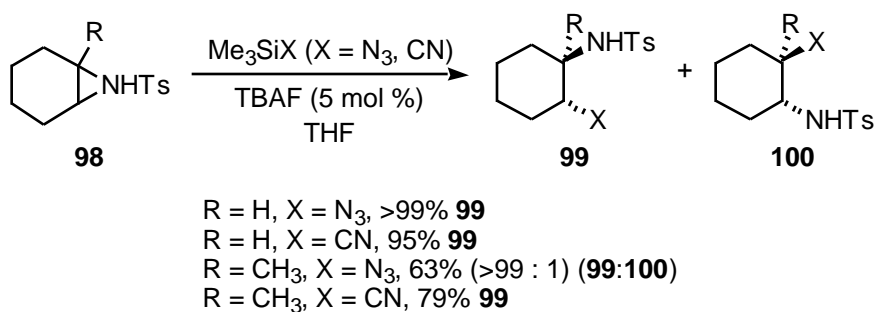

Aggarwal demonstrated a potential limitation of the Me_3SiX /TBAF strategy: although this method is relatively mild, highly base-sensitive substrates can react with TBAF to yield undesired elimination products.²²⁷ As illustrated in Scheme 43, eq. a, attempts by Aggarwal to isolate the ring-opened nitrile **102** were thwarted by formation of alkene **103**. Control experiments by Aggarwal implicated TBAF as the cause of elimination (Scheme 43, eq. b): exposure of an authentic sample of the ring-opened product **104** to TBAF promoted elimination. Regrettably, Aggarwal did not try substituting the less basic TBAT for TBAF as the fluoride source, to preempt unwanted elimination.

Scheme 43

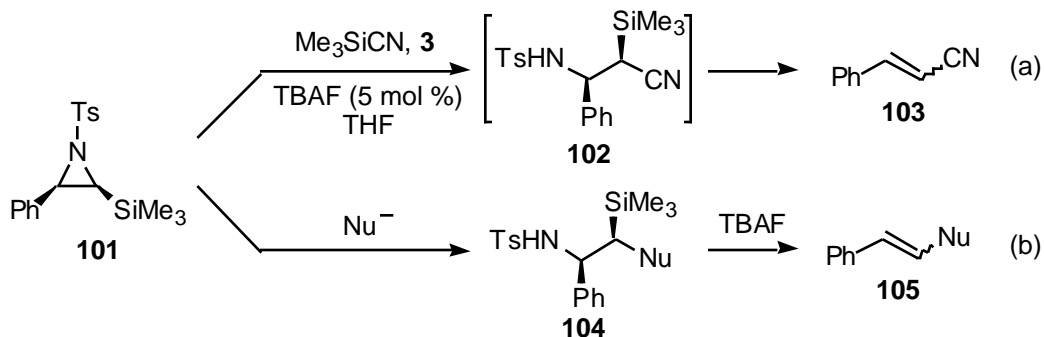

Preliminary reports indicate that mannose and glucose derivatives are poor substrates for cyanide displacement by hypercoordinate cyanosilicate **5** (Scheme 44, eq. a). This is in stark contrast to azide displacements by hypercoordinate azidosilicate **6**: Soli demonstrated the synthesis of glycosyl azides from various glycosyl donors in high yields with excellent regio- and stereocontrol (Scheme 44, eq. b).

Scheme 44

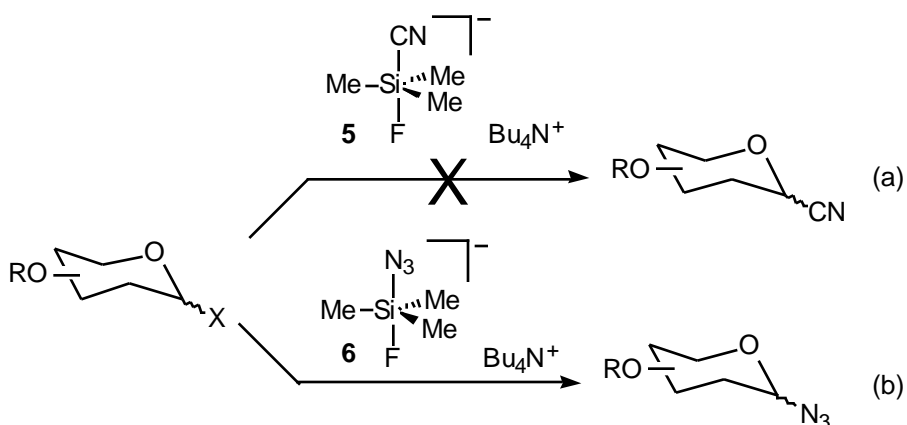

Prompted by the interest of the DeShong research group in methods for the synthesis of mannosyl glycoconjugates, the author and Handy performed investigative experiments which indicated that 6-*O*-tosyl and 1- α -bromo per-*O*-acetylated mannose derivatives (**106** and **107**, respectively) were poor substrates for cyanide displacement. Deacetylation and eventual decomposition of the starting material were observed, even for the primary tosyl sugar (**106**).

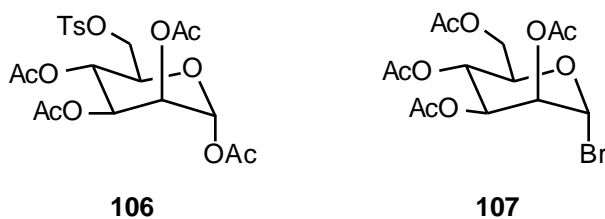

The sensitivity of sugar substrates has been confirmed by Gervay-Hague, using 1- α -iodo per-*O*-benzylated mannose derivative **108** (Scheme 45).²³⁵ When subjected to standard Me₃SiCN/TBAF conditions, the more robust benzyl protecting groups of sugar **108** remained intact, however none of the desired cyano sugar **109** was obtained (Scheme 45, eq. a). Instead, the 1,2-elimination compound **110** was formed quantitatively (Scheme 45, eq. b).

Scheme 45

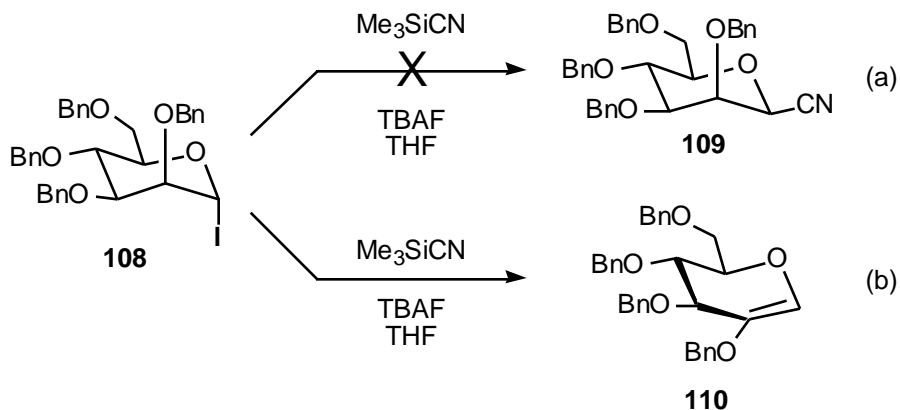

The method described herein for the *in situ* formation of reactive hypercoordinate fluorosilicates is potentially quite general; the Me_3SiCN /TBAF methodology is a prototype for the delivery of other anions. For example, trimethylsilyl isocyanate ($\text{Me}_3\text{Si}(\text{NCO})$) is commercially available, and upon activation with TBAF has the potential of delivering the synthetically valuable¹⁹⁰ isocyanate nucleophile *via* hypercoordinate silicate **111**.

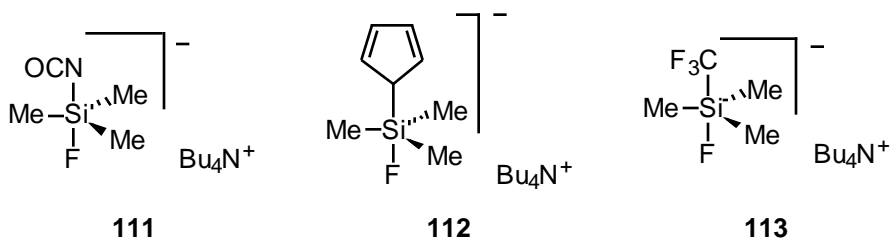

Preliminary studies by Poli indicate that cyclopentadienyl fluorosilicate **112** is a useful source of cyclopentadienyl anion for the synthesis of organomolybdenum complexes where other reagents fail; compound **112** is generated *in situ* by treatment of 5-(trimethylsilyl)-1,3-cyclopentadiene with TBAF.²³⁶ Lastly, the utilization of Me_3SiCF_3 /TBAF for the transfer of trifluoromethyl anion has recently been reported; the researchers attributed the relative mildness and low basicity of this method to the formation of hypercoordinate silicate intermediate **113**.²³⁷⁻²⁴¹

The scope of this methodology continues to be more precisely defined outside of the DeShong laboratories, as new reports of its application to complex natural product

synthesis appear in the literature.^{225,229,242} Although no further optimization of this technique is planned, the DeShong group does continue to employ this reaction for the synthesis of glycosyl azide derivatives.²⁴³

Experimental

General. Thin layer chromatography (TLC) was performed on 0.25 mm Merck silica-coated glass plates treated with a UV-active binder, with the compounds being visualized in one or more of the following manners: UV (254 nm), iodine, or vanillin/sulfuric acid charring. Flash chromatography was performed using thick-walled glass columns and medium-pressure silica gel (Davisil® 200-425 mesh) as described by Still.²⁴⁴ Flash chromatography data is reported as: (column diameter in mm, column height in cm, solvent).

Infrared spectra were recorded on a Nicolet 5DXC FT-IR spectrophotometer with the samples prepared as stated. Band positions are given in reciprocal centimeters (cm^{-1}) and relative intensities are listed as br (broad), vs (very strong), s (strong), m (medium), or w (weak).

Melting points were taken in Kimax soft glass capillary tubes using a Thomas-Hoover Uni-Melt capillary melting point apparatus (Model 6406K) equipped with a calibrated thermometer. Melting points are corrected.

Nuclear magnetic resonance (^1H , ^{13}C) spectra were recorded on a Bruker DRX-400 spectrometer. Chemical shifts are reported in parts per million (δ) downfield from tetramethylsilane (TMS). Coupling constants (J values) are reported in Hertz (Hz), and spin multiplicities are indicated by the following symbols: s (singlet), d (doublet), t (triplet), q (quartet), m (multiplet), br s (broad singlet).

Low resolution (MS) and high resolution mass spectra (HRMS) were obtained on a VG-7070E magnetic sector instrument equipped with a 486 PC-based data system. GCMS was performed on a Shimadzu QP5000MS coupled with a GC17A gas chromatograph.

Gas chromatography was performed on a Hewlett Packard 5890 GC equipped with a flame ionization detector using a 25 m methyl silicon column.

Methyl sulfoxide (DMSO), and acetonitrile (MeCN) were each distilled from calcium hydride. Dioxane was distilled from sodium-benzophenone ketyl.



All reagents and alkyl halides were purchased from Acros or Aldrich and purified using the method of Perrin²⁴⁵ prior to use, or prepared by literature procedure as noted. The substrate 2-iodooctane²⁴⁶ was prepared according to the literature procedure. In the case of alkyl sulfonates **75** and **79**, the appropriate sulfonate was synthesized from the alcohol immediately before use using the literature method^{247,248} and the crude isolated sulfonate was used without further purification. Tetrabutylammonium fluoride (TBAF) was purchased from Acros as a 1.0 M solution in THF and used as received. Tetrabutylammonium triphenyldifluorosilicate (TBAT) was prepared according to the literature procedure.⁴⁸

Glassware used in the reactions described below was dried for a minimum of 12 h in an oven at 120 °C. All reactions were run under an atmosphere of nitrogen or argon at room temperature unless otherwise noted.

All compounds were determined to be >95% pure by ¹H NMR unless otherwise noted.

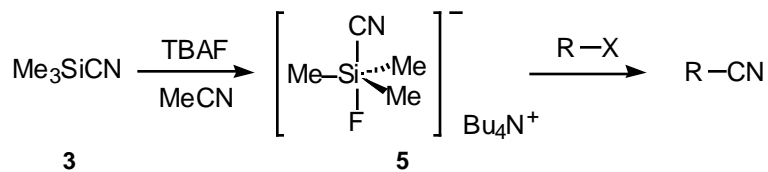
General Procedure for Synthesis of Nitriles Using Trimethylsilyl Cyanide (Me₃SiCN, **3) and Tetrabutylammonium Fluoride (TBAF) (Table 6).** Trimethylsilyl cyanide (149 mg, 200 μL, 1.50 mmol) and TBAF (1 M in THF, 1.5 mL, 1.5 mmol) were added to a stirring solution of the alkyl halide (1.00 mmol, 1 equiv) in 10 mL solvent (MeCN or dioxane) under an atmosphere of nitrogen. Unless otherwise noted, the reaction was performed at the given temperature until GC analysis indicated that the starting material had been consumed. The reaction mixture was concentrated *in vacuo*, and the resulting syrup was purified by flash chromatography.

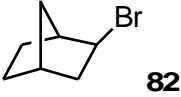
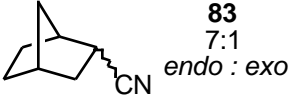
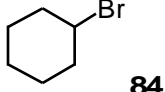
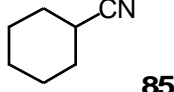

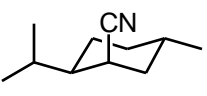
Entry	Substrate R-X	Product R-CN	Temp (°C)	Time (h)	Yield ^{a,b} (%)
1	(C ₆ H ₅)CH ₂ Br 64	(C ₆ H ₅)CH ₂ CN 65	82 25	0.1 1	95 (>95)
2	(C ₆ H ₅)CH ₂ Cl 70	(C ₆ H ₅)CH ₂ CN 65	82 25	2 72	(>95) (>95)
3	CH ₃ (CH ₂) ₁₁ I 71	CH ₃ (CH ₂) ₁₁ CN 72	82 25	0.1 6	95 (95)
4	CH ₃ (CH ₂) ₁₁ Br 73	CH ₃ (CH ₂) ₁₁ CN 72	82 25	2 36	95 (>95)
5	CH ₃ (CH ₂) ₁₁ Cl 74	CH ₃ (CH ₂) ₁₁ CN 72	82 25	3 96	95 (33) ^c
6	CH ₃ (CH ₂) ₁₁ OMs 75	CH ₃ (CH ₂) ₁₁ CN 72	82	0.1	95
7	(C ₆ H ₅)CH ₂ CH ₂ Br 67	(C ₆ H ₅)CH ₂ CH ₂ CN 68	82 25	0.1 32	95 (>95)
8	CH ₃ (CH ₂) ₅ CH(I)CH ₃ 76	CH ₃ (CH ₂) ₅ CH(CN)CH ₃ 77	82 25	1 72	(83) (68)
9	CH ₃ (CH ₂) ₅ CH(Br)CH ₃ 78	CH ₃ (CH ₂) ₅ CH(CN)CH ₃ 77	82 25	2 120	(82) (79)
10	CH ₃ (CH ₂) ₅ CH(OTs)CH ₃ 79	CH ₃ (CH ₂) ₅ CH(CN)CH ₃ 77	82 25	1 48	(76) (70)
11	(C ₆ H ₅)CH(Br)CH ₃ 80	(C ₆ H ₅)CH(CN)CH ₃ 81	82 25	1 5	92 (>95)
12	 82	 83 7:1 <i>endo</i> : <i>exo</i>	82 101 ^e	48 96	(0) ^d 70
13	 84	 85	82	48	(<5) ^f
14	 86	 87	82 101 ^e	48 96	(0) ^d (0) ^d

^a The indicated substrate, Me₃SiCN (**3**), and TBAF (1:1.5:1.5 molar ratio) in acetonitrile were allowed to react at the given temperature, unless otherwise noted. ^b Isolated yield after purification. The yield determined by G.C. analysis of the crude reaction mixture (vs. an internal standard) is reported in parentheses. ^c Reaction was stopped before completion. ^d No reaction was observed. ^e Reaction was performed in dioxane. ^f Starting material was consumed; remaining yield assumed to be cyclohexene.

Table 6. Reaction of Hypercoordinate Silicate **5** with Alkyl Halides.

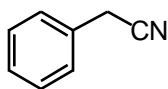

Phenylacetonitrile (65) (Table 6, entry 1). The above general procedure for the synthesis of nitriles using trimethylsilyl cyanide and TBAF was followed using benzyl bromide (**64**) (171 mg, 119 μ L, 1.00 mmol), trimethylsilyl cyanide (149 mg, 200 μ L, 1.50 mmol) and TBAF (1.5 mL, 1.5 mmol) in 10 mL of MeCN. The reaction was heated at reflux for 5 min. Flash chromatography (25 mm, 16 cm, 10% CH₂Cl₂/pentane) afforded 111 mg (95%) of **65** as a colorless oil. TLC R_f = 0.40 (30% CH₂Cl₂/pentane). IR (thin film) 3092 (s), 3069 (s), 3035 (s), 2912 (w), 2254 (m), 1604 (m), 1549 (m), 1497 (vs), 1416 (vs) cm⁻¹; ¹H NMR (CDCl₃) δ 3.65 (s, 2H), 7.23-7.35 (m, 5H); ¹³C NMR (CDCl₃) δ 23.4, 118.0, 127.8, 127.9, 129.0, 130.0. The IR, ¹H and ¹³C NMR data were identical to an authentic sample purchased from Aldrich, as well as published spectral data.^{218,249}

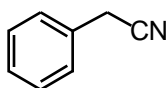

Phenylacetonitrile (65) (Table 6, entry 2). The above general procedure for the synthesis of nitriles using trimethylsilyl cyanide and TBAF was followed using benzyl chloride (**70**) (127 mg, 115 μ L, 1.00 mmol), trimethylsilyl cyanide (149 mg, 200 μ L, 1.50 mmol) and TBAF (1.5 mL, 1.5 mmol) in 10 mL of MeCN. The reaction was heated at reflux for 2 h. Flash chromatography (25 mm, 16 cm, 10% CH₂Cl₂/pentane) afforded 114 mg (97%) of **65** as a colorless oil. Spectral data is reported above.

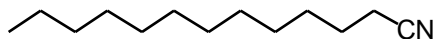

Tridecanenitrile (72) (Table 6, entry 5). The above general procedure for the synthesis of nitriles using trimethylsilyl cyanide and TBAF was followed using 1-chlorododecane (**74**) (205 mg, 236 μ L, 1.00 mmol), trimethylsilyl cyanide (149 mg, 200 μ L, 1.50 mmol) and TBAF (1.5 mL, 1.5 mmol) in 10 mL of MeCN. The reaction was heated at reflux for 2 h. Flash chromatography (25 mm, 16 cm, 5% CH₂Cl₂/pentane) afforded 186 mg (95%) of **72**. Spectral data is reported above.

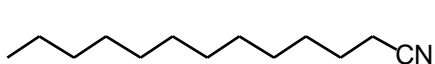

Tridecanenitrile (72) (Table 6, entry 6). The above general procedure for the synthesis of nitriles

using trimethylsilyl cyanide and TBAF was followed using methanesulfonic acid dodecyl ester (**75**) (264 mg, 1.00 mmol), trimethylsilyl cyanide (149 mg, 200 μ L, 1.50 mmol) and TBAF (1.5 mL, 1.5 mmol) in 10 mL of MeCN. The reaction was heated at reflux for 5 min. Flash chromatography (25 mm, 16 cm, 5% CH_2Cl_2 /pentane) afforded 186 mg (95%) of **72**. Spectral data is reported above.

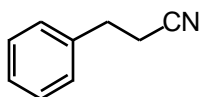

Hydrocinnamonitrile (68) (Table 6, entry 7). The above general procedure for the synthesis of nitriles using trimethylsilyl cyanide and TBAF was followed using phenethyl bromide (**67**) (185 mg, 137 μ L,

1.00 mmol), trimethylsilyl cyanide (149 mg, 200 μ L, 1.50 mmol) and TBAF (1.5 mL, 1.5 mmol) in 10 mL of MeCN. The reaction was heated at reflux for 5 min. Flash chromatography (25 mm, 16 cm, 10% CH_2Cl_2 /pentane) afforded 125 mg (95%) of **68** as a colorless oil. TLC R_f = 0.35 (30% CH_2Cl_2 /pentane). IR (thin film) 3090 (w), 3067 (m), 3032 (s), 2935 (m), 2869 (w), 2250 (w), 1606 (w), 1497 (s), 1455 (s), 1426 (s) cm^{-1} ; ^1H NMR (CDCl_3) δ 2.50 (t, J = 7.4, 2H), 2.85 (t, J = 7.4, 2H), 7.17-7.31 (m, 5H); ^{13}C NMR (CDCl_3) δ 19.1, 31.3, 119.2, 127.0, 128.2, 128.7, 138.1. The IR, ^1H and ^{13}C NMR data were identical to an authentic sample, as well as published spectral data.^{218,250}

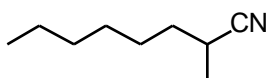

2-Methyloctanenitrile (77) (Table 6, entry 8). The above general procedure for the synthesis of nitriles using trimethylsilyl

cyanide and TBAF was followed using 2-iodooctane (**76**) (240 mg, 1.00 mmol), trimethylsilyl cyanide (149 mg, 200 μ L, 1.50 mmol) and TBAF (1.5 mL, 1.5 mmol) in 10 mL of MeCN. The reaction was heated at reflux for 1 h. Flash chromatography (25 mm, 16 cm, 10% CH_2Cl_2 /pentane) afforded 116 mg (83%) of **77** as a colorless oil. TLC R_f = 0.65 (30% CH_2Cl_2 /pentane). IR (thin film) 2949 (vs), 2855 (vs), 2240 (w), 1461 (m), 1451 (m), 1390 (m) cm^{-1} ; ^1H NMR (CDCl_3) δ 0.89 (t, J = 6.8, 3H), 1.22-1.40 (m, 8H), 1.31 (d, J = 7.0, 3H), 1.44-1.67 (m, 2H), 2.52-2.67 (m, 1H); ^{13}C NMR (CDCl_3) δ 13.8, 17.9, 22.4, 25.3, 26.8, 28.6, 31.4, 33.9, 122.9. The IR, ^1H and ^{13}C NMR data were identical to published spectral data.^{220,251,252}

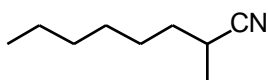

2-Methyloctanenitrile (77) (Table 6, entry 9). The above general procedure for the synthesis of nitriles using trimethylsilyl cyanide and TBAF was followed using 2-bromooctane (**78**) (193 mg, 1.00 mmol), trimethylsilyl cyanide (149 mg, 200 μ L, 1.50 mmol) and TBAF (1.5 mL, 1.5 mmol) in 10 mL of MeCN. The reaction was heated at reflux for 1 h. Flash chromatography (25 mm, 16 cm, 10% CH_2Cl_2 /pentane) afforded 114 mg (82%) of **77** as a colorless oil. Spectral data is reported above.

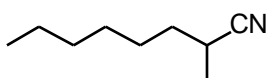

2-Methyloctanenitrile (77) (Table 6, entry 10). The above general procedure for the synthesis of nitriles using trimethylsilyl cyanide and TBAF was followed using *p*-toluenesulfonic acid 1-methyl-heptyl ester (**79**) (284 mg, 1.00 mmol), trimethylsilyl cyanide (149 mg, 200 μ L, 1.50 mmol) and TBAF (1.5 mL, 1.5 mmol) in 10 mL of MeCN. The reaction was heated at reflux for 1 h. Flash chromatography (25 mm, 16 cm, 10% CH_2Cl_2 /pentane) afforded 114 mg (82%) of **77** as a colorless oil. Spectral data is reported above.

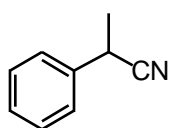

2-Phenylpropionitrile (81) (Table 6, entry 11). The above general procedure for the synthesis of nitriles using trimethylsilyl cyanide and TBAF was followed using 1-(bromoethyl)benzene (**70**) (185 mg, 136 μ L, 1.00 mmol), trimethylsilyl cyanide (149 mg, 200 μ L, 1.50 mmol) and TBAF (1.5 mL, 1.5 mmol) in 10 mL of MeCN. The reaction was heated at reflux for 5 min. Flash chromatography (25 mm, 16 cm, 10% CH_2Cl_2 /pentane) afforded 121 mg (92%) of **81** as a colorless oil. TLC R_f = 0.45 (30% CH_2Cl_2 /pentane). IR (thin film) 3091 (m), 3068 (m), 3033 (s), 2987 (s), 2939 (m), 2878 (m), 2244 (m), 1453 (s) cm^{-1} ; ^1H NMR (CDCl_3) δ 1.56 (d, J = 7.3, 3H), 3.84 (q, J = 7.3, 1H), 7.28-7.34 (m, 5H); ^{13}C NMR (CDCl_3) δ 21.4, 31.1, 121.6, 126.7, 128.0, 129.1, 137.1. The IR, ^1H and ^{13}C NMR data were identical to an authentic sample, as well as published spectral data.^{218,250}

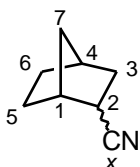

endo/exo-2-Norbornane Carbonitrile (83) (Table 6, entry 12). The above general procedure for the synthesis of nitriles using trimethylsilyl cyanide and TBAF was followed using *exo*-2-bromonorbornane (**82**) (175 mg, 128 μ L, 1.00 mmol), trimethylsilyl cyanide (149 mg, 200 μ L, 1.50 mmol) and TBAF (1.5 mL, 1.5 mmol) in 10 mL of dioxane. The reaction was heated at reflux for 96 h. Flash chromatography (25 mm, 16 cm, 10% CH_2Cl_2 /pentane) afforded 85 mg (70%) of *endo/exo*-**83** as a colorless oil. TLC R_f = 0.50 (30% CH_2Cl_2 /pentane). IR (CCl_4) 2970 (b), 2876 (s), 2238 (m), 1456 (m) cm^{-1} ; ^1H NMR (CDCl_3) δ 1.1-1.9 (m, 7.4H), 1.9-2.1 (m, 0.9H), 2.3-2.4 (m, 1.2H), 2.5 (s, 0.7H), 2.6 (s, 0.2H), 2.6-2.7 (m, 0.6H); ^{13}C NMR (CDCl_3) assigned as *endo*: δ 25.1 (C6), 29.2 (C5), 30.2 (C2), 35.5 (C3), 36.6 (C4), 38.9 (C7), 40.0 (C1), 123.0 (Cx); assigned as *exo*: δ 28.5, (C6), 28.6 (C5), 31.2 (C2), 36.1 (C3), 36.2 (C4), 37.3 (C7), 41.9 (C1), 123.7 (Cx). The IR, ^1H and ^{13}C NMR data were identical, except for the *endo/exo* ratio, to an authentic sample, as well as published spectral data.^{218,219,249} The *endo/exo* ratio was determined by integration of the ^{13}C NMR spectrum: the relative areas of the carbon signals as shown above were: C6 (6.91:1.00), C1 (6.94:100), Cx (6.92:1.00), for an average *endo/exo* ratio of 6.92:1.0.

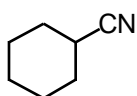

Cyclohexanecarbonitrile (85) (Table 6, entry 13). The above general procedure for the synthesis of nitriles using trimethylsilyl cyanide and TBAF was followed using cyclohexyl bromide (**84**) (163 mg, 124 μ L, 1.00 mmol), trimethylsilyl cyanide (149 mg, 200 μ L, 1.50 mmol) and TBAF (1.5 mL, 1.5 mmol) in 10 mL of MeCN. The reaction was heated at reflux for 48 h. GC analysis indicated complete consumption of the starting material, and formation of a trace amount (<5%) of cyclohexanecarbonitrile (**85**). Cyclohexanecarbonitrile (**85**) was identified by comparison of the GC retention time of an authentic sample. The remaining yield was assumed to be cyclohexene, which was neither observed by GC nor isolated, due to volatility.

General Procedure For the Reaction of Benzyl Bromide (64) with Trimethylsilyl Cyanide (3) and Varying Amounts of Tetrabutylammonium Fluoride (TBAF) (Table 7). All reactions were performed on a 1.0 mmol scale. Trimethylsilyl cyanide (149 mg, 200 μ L, 1.50 mmol), and the indicated amount of TBAF were added to a stirring solution of benzyl bromide (64) (171 mg, 119 μ L, 1.00 mmol) and the internal standard naphthalene (128 mg, 1.0 mmol, 1.0 equiv) in 10 mL MeCN under an atmosphere of nitrogen. The reaction was stirred at room temperature for 1 h, when GC analysis indicated that all reactions had ceased to progress. Reaction progress was monitored by GC analysis of aliquots of the quenched reaction mixture. GC response factors relative to the internal naphthalene standard were determined, and the observed percentages of products were normalized accordingly.

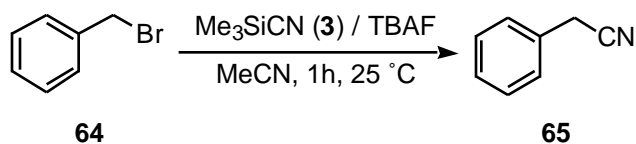

Entry	TBAF (mol %)	Yield ^{a,b,c} (%)
1	100	89
2	50	42
3	25	15

^a Benzyl bromide (64, 1 equiv), Me₃SiCN (3, 1.5 equiv), and the given amount of TBAF in MeCN were allowed to react at room temperature. ^b Reactions were complete by 1 h. ^c Yield of 65 determined by G.C. analysis of the crude reaction mixture (vs. an internal standard).

Table 7. Reaction of Benzyl Bromide (64) with Me₃SiCN (3) and Varying Amounts of TBAF.

General Procedure for the Reaction of Benzyl Bromide (64) and Trimethylsilyl Cyanide (3) with Tetrabutylammonium Nucleophiles (Table 8). All reactions were performed on a 1.0 mmol scale. Trimethylsilyl cyanide (149 mg, 200 μ L, 1.50 mmol), and the indicated tetrabutylammonium salt (1.5 mmol, 1.5 equiv) were added to a stirring solution of benzyl bromide (**64**) (119 μ L, 1.00 mmol) and the internal standard naphthalene (128 mg, 1.0 mmol, 1.0 equiv) in 10 mL MeCN under an atmosphere of nitrogen. The reaction was stirred at reflux until GC analysis indicated that the reaction had ceased to progress. Reaction progress was monitored by GC analysis of aliquots of the quenched reaction mixture. GC response factors relative to the internal naphthalene standard were determined, and the observed percentages of products were normalized accordingly.

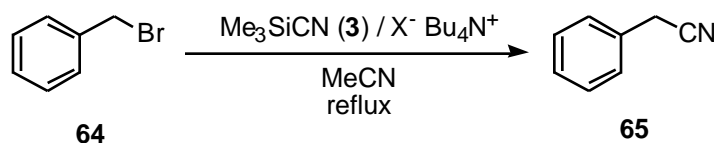

Entry	Nucleophile	Time (h)	Yield (%) ^{a,b}
1	F ⁻ Bu ₄ N ⁺	0.1	>95
2	Br ⁻ Bu ₄ N ⁺	24	0
3	Cl ⁻ Bu ₄ N ⁺	24	0
4	I ⁻ Bu ₄ N ⁺	24	0
5	TfO ⁻ Bu ₄ N ⁺	24	0
6	AcO ⁻ Bu ₄ N ⁺	0.1	45 ^c

^a Benzyl bromide (**64**) (1 equiv), Me₃SiCN (1.5 equiv), and the indicated nucleophile (1.5 equiv) in MeCN were allowed to react at reflux. ^b The yield of **65** was determined by G.C. analysis of the crude reaction mixture (vs. an internal standard). ^c Reaction was allowed to proceed for 24 h, but no additional progress was detected.

Table 8. Reaction of Benzyl Bromide (**64**) and Trimethylsilyl Cyanide (**3**) with Tetrabutylammonium Nucleophiles.

General Procedure for the Reaction of Benzyl Bromide (64) and Trimethylsilyl Cyanide (3) with Alternative Fluoride Sources (Table 9). All reactions were performed on a 1.0 mmol scale. Trimethylsilyl cyanide (149 mg, 200 μ L, 1.50 mmol), and the indicated fluoride salt (1.5 mmol, 1.5 equiv) were added to a stirring solution of benzyl bromide (64) (119 μ L, 1.00 mmol) and the internal standard naphthalene (128 mg, 1.0 mmol, 1.0 equiv) in 10 mL MeCN under an atmosphere of nitrogen. The reaction was stirred at reflux until GC analysis indicated that the reaction had ceased to progress. Reaction progress was monitored by GC analysis of aliquots of the quenched reaction mixture. GC response factors relative to the internal naphthalene standard were determined, and the observed percentages of products were normalized accordingly.

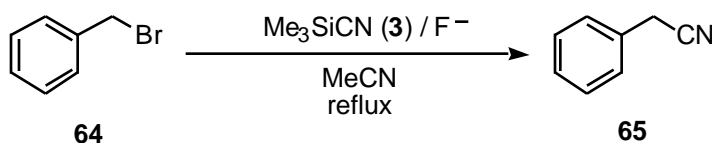

Entry	Fluoride Salt	Time (h)	Yield (%) ^{a,b}
1	Bu ₄ N ⁺ F ⁻	>1	100
2	KF	72	80 ^c
3	KF / 18-crown-6 ^d	48	100
4	CsF	48	75 ^c
5	TBAT, 1	>1	100

^a Benzyl bromide (**64**) (1.0 equiv), Me₃SiCN (**3**) (1.5 equiv), and the indicated fluoride salt (1.5 equiv) in MeCN were allowed to react at reflux. ^b The yield of **65** was determined by G.C. analysis of the crude reaction mixture (vs. an internal standard). ^c Reaction was allowed to proceed for an additional 24 hours, but no further progress was detected. ^d Catalytic in 18-crown-6 (20 mol %).

Table 9. Reaction of Benzyl Bromide (**64**) and Trimethylsilyl Cyanide (**3**) with Alternative Fluoride Sources.

General Procedure for the Reaction of Secondary Alkyl Halides with

Trimethylsilyl Cyanide (3) and TBAT (1) (Table 10). All reactions were performed on a 1.0 mmol scale. Trimethylsilyl cyanide (149 mg, 200 μ L, 1.50 mmol), and TBAT (1) (874 mg, 1.5 mmol) were added to a stirring solution of alkyl halide (1.00 mmol, 1 equiv) and the internal standard naphthalene (128 mg, 1.0 mmol, 1.0 equiv) in 10 mL MeCN under an atmosphere of nitrogen. The reaction was performed at 82 $^{\circ}$ C until GC analysis indicated that the reaction had ceased to progress. Reaction progress was monitored by GC analysis of aliquots of the quenched reaction mixture. GC response factors relative to the internal naphthalene standard were determined, and the observed percentages of products were normalized accordingly. The elimination product 2-octene was identified by comparison of the GC retention time to the value of that of an authentic sample

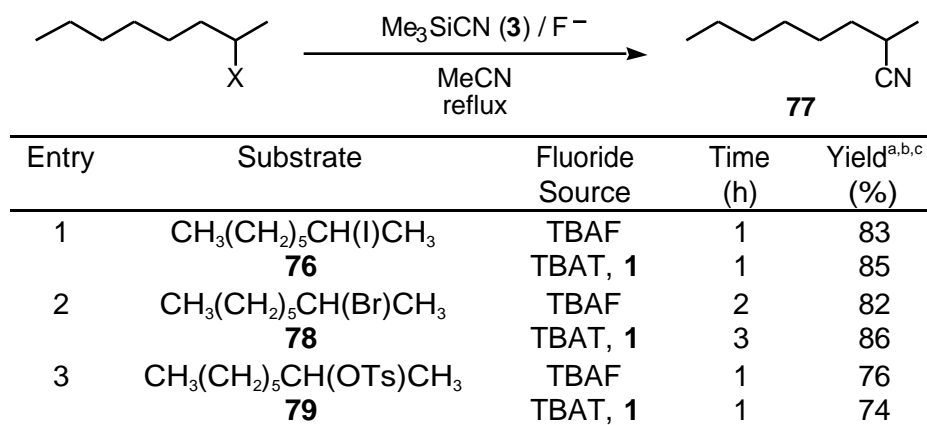

^a The yield of **77** was determined by G.C. analysis of the crude reaction mixture (vs. an internal standard). ^b All reactions went to completion; the remaining yield was 2-octene. ^c The remaining yield was 2-octene.

Table 10. Reaction of Secondary Alkyl Halides with Trimethylsilyl Cyanide (3) and TBAF or TBAT (1).

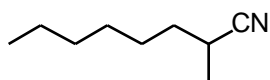

2-Methyloctanenitrile (77) (Table 10, entry 1). The above general procedure for the reaction of secondary alkyl halides with trimethylsilyl cyanide and TBAT was followed using 2-iodooctane (**76**) (240 mg, 1.00 mmol), trimethylsilyl cyanide (149 mg, 200 μ L, 1.50 mmol) and TBAT (874 mg, 1.50 mmol) in 10 mL of MeCN. The reaction was heated at reflux for 1 h to yield 85% of **77** by GC analysis.

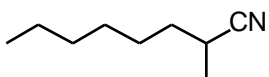

2-Methyloctanenitrile (77) (Table 10, entry 2). The above general procedure for the reaction of secondary alkyl halides with trimethylsilyl cyanide and TBAT was followed using 2-bromooctane (**78**) (193 mg, 1.00 mmol), trimethylsilyl cyanide (149 mg, 200 μ L, 1.50 mmol) and TBAT (874 mg, 1.50 mmol) in 10 mL of MeCN. The reaction was heated at reflux for 3 h to yield 86% of **77** by GC analysis.

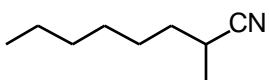

2-Methyloctanenitrile (77) (Table 10, entry 3). The above general procedure for the reaction of secondary alkyl halides with trimethylsilyl cyanide and TBAT was followed using toluene-4-sulfonic acid 1-methyl-heptyl ester (**79**) (284 mg, 1.00 mmol), trimethylsilyl cyanide (149 mg, 200 μ L, 1.50 mmol) and TBAT (874 mg, 1.50 mmol) in 10 mL of MeCN. The reaction was heated at reflux for 1 h to yield 74% of **77** by GC analysis.

General Procedure for Synthesis of Nitriles Using Tetrabutylammonium Cyanide (90) (Table 11). All reactions were performed on a 1.0 mmol scale. The indicated alkyl halide (1.00 mmol, 1 equiv) was added to a stirring solution of tetrabutylammonium cyanide (**90**) (403 mg, 1.50 mmol) and the internal standard naphthalene (128 mg, 1.0 mmol, 1.0 equiv) in 10 mL MeCN under an atmosphere of nitrogen. The reaction was stirred at the given temperature until GC analysis indicated that the reaction had ceased to progress. Reaction progress was monitored by GC analysis of aliquots of the quenched reaction mixture. GC response factors relative to the internal naphthalene standard were determined, and the observed percentages of products were normalized accordingly.

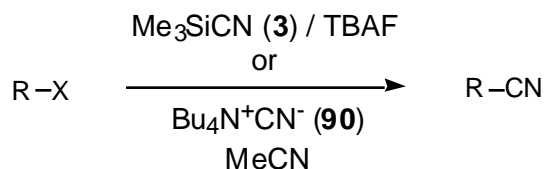

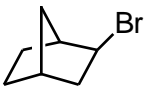
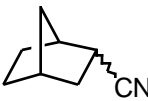
Entry	Substrate	Product	Reagent	Temp (°C)	Time (h)	Yield ^{a,b} (%)
1	CH ₃ (CH ₂) ₁₁ I 71	CH ₃ (CH ₂) ₁₁ CN 72	3 /TBAF Bu ₄ N ⁺ CN ⁻	25	6	95
2	CH ₃ (CH ₂) ₁₁ Br 73	CH ₃ (CH ₂) ₁₁ CN 72	3 /TBAF Bu ₄ N ⁺ CN ⁻	25	36	>95
3	CH ₃ (CH ₂) ₁₁ Cl 74	CH ₃ (CH ₂) ₁₁ CN 72	3 /TBAF Bu ₄ N ⁺ CN ⁻	25	96	33 ^c
4	(C ₆ H ₅)CH ₂ CH ₂ Br 67	(C ₆ H ₅)CH ₂ CH ₂ CN 68	3 /TBAF Bu ₄ N ⁺ CN ⁻	25	32	>95
5	CH ₃ (CH ₂) ₅ CH(I)CH ₃ 76	CH ₃ (CH ₂) ₅ CH(CN)CH ₃ 77	3 /TBAF Bu ₄ N ⁺ CN ⁻	25	72	68
6	CH ₃ (CH ₂) ₅ CH(Br)CH ₃ 78	CH ₃ (CH ₂) ₅ CH(CN)CH ₃ 77	3 /TBAF Bu ₄ N ⁺ CN ⁻	25	120	79
7	CH ₃ (CH ₂) ₅ CH(OTs)CH ₃ 79	CH ₃ (CH ₂) ₅ CH(CN)CH ₃ 77	3 /TBAF Bu ₄ N ⁺ CN ⁻	25	48	70
8	(C ₆ H ₅)CH(Br)CH ₃ 80	(C ₆ H ₅)CH(CN)CH ₃ 81	3 /TBAF Bu ₄ N ⁺ CN ⁻	25	5	>95
9	 82	 83 7:1 <i>endo</i> : <i>exo</i>	3 /TBAF Bu ₄ N ⁺ CN ⁻	82 101 ^e	48 96	0 ^d 70

^a Where **3**/TBAF is the reagent, the indicated substrate, Me₃SiCN (**3**), and TBAF (1:1.5:1.5 molar ratio) in acetonitrile were allowed to react at the given temperature, unless otherwise noted. Where Bu₄N⁺CN⁻ (**90**) is the reagent, the indicated substrate, and Bu₄N⁺CN⁻ (1:1.5 molar ratio) in acetonitrile were allowed to react at the given temperature.

^b Yield determined by G.C. analysis of the crude reaction mixture (vs. an internal standard). ^c Reaction was stopped before completion. ^d No reaction was observed. ^e Reaction was performed in dioxane.

Table 11. Comparison of Nitrile Synthesis Using Me₃SiCN/TBAF or Bu₄N⁺CN⁻.

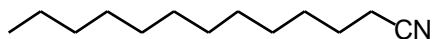

Tridecanenitrile (72) (Table 11, entry 1).

The above general procedure for the synthesis of nitriles using tetrabutylammonium cyanide was followed using 1-iodododecane (**71**) (296 mg, 247 μ L, 1.00 mmol), and tetrabutylammonium cyanide (404 mg, 1.50 mmol) in 10 mL of MeCN. The reaction was stirred at room temperature for 1 h to yield 95% of **72** by GC analysis.

Tridecanenitrile (72) (Table 11, entry 2).



The above general procedure for the

synthesis of nitriles using tetrabutylammonium cyanide was followed using 1-bromododecane (**73**)

(249 mg, 240 μ L, 1.00 mmol), and tetrabutylammonium cyanide (404 mg, 1.50 mmol) in 10 mL of MeCN. The reaction was stirred at room temperature for 3 h to yield 97% of **72** by GC analysis.



Tridecanenitrile (72) (Table 11, entry 3).

The above general procedure for the synthesis of nitriles using tetrabutylammonium cyanide was followed using 1-chlorododecane (**74**) (205 mg, 236 μ L, 1.00 mmol), and tetrabutylammonium cyanide (404 mg, 1.50 mmol) in 10 mL of MeCN. The reaction was stirred at room temperature for 36 h to yield 97% of **72** by GC analysis.

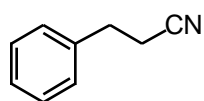

Hydrocinnamonitrile (68) (Table 11, entry 4).

The above general procedure for the synthesis of nitriles using tetrabutylammonium cyanide was followed using phenethylbromide (**67**) (185 mg, 137 μ L, 1.00 mmol), and tetrabutylammonium cyanide (404 mg, 1.50 mmol) in 10 mL of MeCN. The reaction was stirred at room temperature for 2 h to yield 100% of **68** by GC analysis.

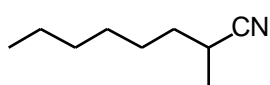

2-Methyloctanenitrile (77) (Table 11, entry 5). The above general procedure for the synthesis of nitriles using tetrabutylammonium cyanide was followed using 2-iodooctane (**76**) (240 mg, 1.00 mmol), and tetrabutylammonium cyanide (404 mg, 1.50 mmol) in 10 mL of MeCN. The reaction was stirred at room temperature for 24 h to yield 71% of **77** by GC analysis.

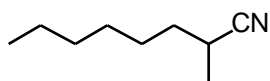

2-Methyloctanenitrile (77) (Table 11, entry 6). The above general procedure for the synthesis of nitriles using tetrabutylammonium cyanide was followed using 2-bromooctane (**78**) (193 mg, 1.00 mmol), and tetrabutylammonium cyanide (404 mg, 1.50 mmol) in 10 mL of MeCN. The reaction was stirred at room temperature for 96 h to yield 77% of **77** by GC analysis.

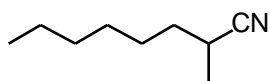

2-Methyloctanenitrile (77) (Table 11, entry 7). The above general procedure for the synthesis of nitriles using tetrabutylammonium cyanide was followed using toluene-4-sulfonic acid 1-methyl-heptyl ester (**79**) (284 mg, 1.00 mmol), and tetrabutylammonium cyanide (404 mg, 1.50 mmol) in 10 mL of MeCN. The reaction was stirred at room temperature for 24 h to yield 74% of **77** by GC analysis.

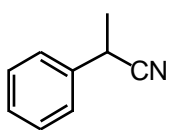

2-Phenylpropionitrile (81) (Table 11, entry 8). The above general procedure for the synthesis of nitriles using tetrabutylammonium cyanide was followed using (1-bromoethyl)benzene (**80**) (185 mg, 136 μ L, 1.00 mmol), and tetrabutylammonium cyanide (404 mg, 1.50 mmol) in 10 mL of MeCN. The reaction was stirred at room temperature for 3 h to yield 99% of **81** by GC analysis.

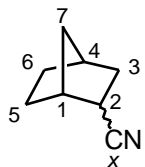

endo/exo-2-Norbornanecarbonitrile (83) (Table 11, entry 9). The above general procedure for the synthesis of nitriles using tetrabutylammonium cyanide was followed using *exo*-2-bromonorbornane (**82**) (175 mg, 128 μ L, 1.00 mmol), and tetrabutylammonium cyanide (404 mg, 1.50 mmol) in 10 mL of dioxane. The reaction was stirred at reflux for 72 h to yield 60% of *endo/exo*-**83** by GC analysis.

References

CHAPTER ONE

1. Hatanaka, Y.; Goda, K.-i.; Okahara, Y. *Tetrahedron* **1994**, *50*, 8301-8316.
2. Tonks, L.; Williams, J. M. J. *J. Chem. Soc., Perkin Trans. 1* **1998**, 3637-3652.
3. Nicolaou, K. C.; Chakraborty, T. K.; Piscopio, A. D.; Minowa, N.; Bertinato, P. J. *J. Am. Chem. Soc.* **1993**, *115*, 4419-4420.
4. Kalivretenos, A.; Stille, J. K.; Hegedus, L. S. *J. Org. Chem.* **1991**, *56*, 2883-2894.
5. Gyorkos, A. C.; Stille, J. K.; Hegedus, L. S. *J. Am. Chem. Soc.* **1990**, *112*, 8465-8472.
6. Smith III, A. B.; Wiu, Y.; Jones, D. R.; Kobayashi, K. *J. Am. Chem. Soc.* **1995**, *117*, 12011-12012.
7. Su, D.-S.; Meng, D.; Bertinato, P.; Balog, A.; Sorensen, E. J.; Danishefsky, S. J.; Zheng, Y.-H.; Chou, T.-C.; He, L.; Horwitz, S. B. *Angew. Chem., Int. Ed. Engl.* **1997**, *36*, 757-759.
8. Hatanaka, Y.; Hiyama, T. *Synlett* **1991**, 845-853.
9. Tamao, K.; Kakui, T.; Akita, M.; Iwahara, T.; Kanatani, R.; Yoshida, J.; Kumada, M. *Tetrahedron* **1983**, *39*, 983-990.
10. *Metal-Catalyzed Cross-Coupling Reactions*; Diederich, F.; Stang, P. J., Eds.; Wiley-VCH: Weinheim, Germany, 1998.
11. Heck, R. F. *Palladium Reagents in Organic Synthesis*; Academic Press: New York, 1985.
12. Tsuji, J. *Palladium Reagents and Catalysts. Innovations in Organic Synthesis*; John Wiley & Sons: New York, 1995.
13. Trost, B. M.; Verhoeven, T. R. In *Comprehensive Organometallic Chemistry*; Wilkinson, G., Stone, F. G. A., Abel, E. W., Eds.; Pergamon: Oxford, 1982; Vol. 8, p 799-938.
14. Tamao, K. In *Comprehensive Organic Synthesis*; Trost, B. M., Fleming, I., Eds.; Pergamon: Oxford, 1991; Vol. 3, p 435-480.
15. Knight, D. W. In *Comprehensive Organic Synthesis*; Trost, B. M., Fleming, I., Eds.; Pergamon: Oxford, 1991; Vol. 3, p 481-578.
16. Casado, A. L.; Espinet, P. *J. Am. Chem. Soc.* **1998**, *120*, 8978-8985.
17. Casado, A. L.; Espinet, P. *Organometallics* **1998**, *17*, 954-959.

18. Stille, J. K.; Echavarren, A. M.; Williams, R. M.; Hendrix, J. A. *Org. Synth.* **1993**, *71*, 97-106.
19. Farina, V.; Krishnamurthy, V.; Scott, W. J. In *Organic Reactions*; Paquette, L. A., Ed.; John Wiley & Sons, Inc.: New York, 1997; Vol. 50.
20. Miyaura, N.; Suzuki, A. *Chem. Rev.* **1995**, *95*, 2457-2483.
21. Mowery, M. E.; DeShong, P. *J. Org. Chem.* **1999**, *64*, 1684-1688.
22. Mowery, M. E.; DeShong, P. *J. Org. Chem.* **1999**, *64*, 3266-3270.
23. Mowery, M. E.; DeShong, P. *Org. Lett.* **1999**, *1*, 2137-2140.
24. Handy, C. J.; Mowery, M. E.; DeShong, P. *Pure Appl. Chem.* **2000**, *72*, 1655-1658.
25. Correia, R.; DeShong, P. *J. Org. Chem.* **2001**, *66*, 7159-7165.
26. Hiyama, T. In *Metal-Catalyzed Cross-Coupling Reactions*; Diederich, F., Stang, P. J., Eds.; Wiley-VCH: Weinheim, Germany, 1998.
27. Hiyama, T.; Hatanaka, Y. *Pure Appl. Chem.* **1994**, *66*, 1471-1478.
28. Hirabayashi, E.; Mori, A.; Kawashima, J.; Suguro, M.; Nishihara, Y.; Hiyama, T. *J. Org. Chem.* **2000**, *65*, 5342-5349.
29. Gouda, K.; Hagiwara, E.; Hatanaka, Y.; Hiyama, T. *J. Org. Chem.* **1996**, *61*, 7232-7233.
30. Hagiwara, E.; Gouda, K.; Hatanaka, Y.; Hiyama, T. *Tetrahedron Lett.* **1997**, *38*, 439-442.
31. Hirabayashi, K.; Kawashima, J.; Nishihara, Y.; Mori, A.; Hiyama, T. *Org. Lett.* **1999**, *1*, 299-301.
32. Homsí, F.; Nozaki, K.; Hiyama, T. *Tetrahedron Lett.* **2000**, *41*, 5869-5872.
33. Homsí, F.; Hosoi, K.; Nozaki, K.; Hiyama, T. *J. Organomet. Chem.* **2001**, *624*, 208-216.
34. Tamao, K.; Kobayashi, K.; Ito, Y. *Tetrahedron Lett.* **1989**, *30*, 6051-6054.
35. Ito, H.; Hosomi, A. *J. Synth. Org. Chem. Jpn.* **2000**, *58*, 274-284.
36. Denmark, S. E.; Wu, Z. *Org. Lett.* **1999**, *1*, 1495-1498.
37. Denmark, S. E.; Choi, J. Y. *J. Am. Chem. Soc.* **1999**, *121*, 5821-5822.
38. Denmark, S. E.; Neuville, L. *Org. Lett.* **2000**, *2*, 3221-3224.
39. Denmark, S. E.; Wehrli, D.; Choi, J. Y. *Org. Lett.* **2000**, *2*, 2491-2494.
40. Denmark, S. E.; Wang, Z. G. *Synthesis* **2000**, 999-1003.
41. Denmark, S. E.; Wehrli, D. *Org. Lett.* **2000**, *2*, 565-568.

42. Denmark, S. E.; Wang, Z. G. *J. Organomet. Chem.* **2001**, *624*, 372-375.
43. Denmark, S. E.; Wang, Z. G. *Org. Lett.* **2001**, *3*, 1073-1076.
44. Denmark, S. E.; Pan, W. T. *Org. Lett.* **2001**, *3*, 61-64.
45. Horn, K. A. *Chem. Rev.* **1995**, *95*, 1317-1350.
46. Chuit, C.; Corriu, R. P. J.; Reye, C.; Young, J. C. *Chem. Rev.* **1993**, *93*, 1371-1448.
47. Lee, H. M.; Nolan, S. P. *Org. Lett.* **2000**, *2*, 2053-2055.
48. Rossi, R.; Carpita, A.; Messeri, T. *Gazz. Chim. Ital.* **1992**, *122*, 65-72.
49. Tamao, K. *J. Synth. Org. Chem. Jpn.* **1990**, *48*, 457-462.
50. Babudri, F.; Farinola, G. M.; Naso, F.; Panessa, D. *J. Org. Chem.* **2000**, *65*, 1554-1557.
51. Groenendaal, L.; Frechet, J. M. J. *J. Org. Chem.* **1998**, *63*, 5675-5679.
52. Hirabayashi, K.; Mori, A. *J. Synth. Org. Chem. Jpn.* **2000**, *58*, 926-933.
53. Mateo, C.; FernandezRivas, C.; Echavarren, A. M.; Cardenas, D. J. *Organometallics* **1997**, *16*, 1997-1999.
54. Mateo, C.; Fernandez-Rivas, C.; Cardenas, D. J.; Echavarren, A. M. *Organometallics* **1998**, *17*, 3661-3669.
55. Franz, A. K.; Woerpel, K. A. *Acc. Chem. Res.* **2000**, *33*, 813-820.
56. Hirabayashi, K.; Kondo, T.; Toriyama, F.; Nishihara, Y.; Mori, A. *Bull. Chem. Soc. Jpn.* **2000**, *73*, 749-750.
57. Ito, H.; Sensui, H.-o.; Arimoto, K.; Miura, K.; Hosomi, A. *Chem. Lett.* **1997**, 639-640.
58. Lam, P. Y. S.; Deudon, S.; Averill, K. M.; Li, R. H.; He, M. Y.; DeShong, P.; Clark, C. G. *J. Am. Chem. Soc.* **2000**, *122*, 7600-7601.
59. Lam, P. Y. S.; Deudon, S.; Hauptman, E.; Clark, C. G. *Tetrahedron Lett.* **2001**, *42*, 2427-2429.
60. Chuit, C.; Corriu, R. J. P.; Reye, C. In *Chemistry of Hypercoordinate Compounds*; Akiba, K.-Y., Ed.; Wiley-VCH: New York, 1999, p 81-146.
61. Gordon, M. S.; Carroll, M. T.; Davis, L. P.; Burggraf, L. W. *J. Phys. Chem.* **1990**, *94*, 8125-8128.
62. Deiters, J. A.; Holmes, R. R. *J. Am. Chem. Soc.* **1990**, *112*, 7197-7202.
63. Hosomi, A. In *Reviews on Heteroatom Chemistry*; Oae, S., Ed.; MYU-Printed in Japan: Tokyo, 1992; Vol. 7, p 214-228.

64. Hosomi, A.; Kohra, S.; Tominaga, Y. *J. Chem. Soc., Chem. Commun.* **1987**, 20, 1517-1518.
65. Hosomi, A.; Kohra, S.; Tominaga, Y. *Chem. Pharm. Bull.* **1988**, 36, 4622-4625.
66. Hojo, M.; Murakami, C.; Aihara, H.; Komori, E.-i.; Kohra, S.; Tominaga, Y.; Hosomi, A. *Bull. Soc. Chim. Fr.* **1995**, 132, 499-508.
67. Mowery, M. E. Doctoral Dissertation, University of Maryland, College Park, 2000.
68. Seganish, W. M.; DeShong, P. *J. Org. Chem.* **2004**, 69, 1137-1143.
69. Mehrotra, R. C. In *Chemistry and Technology of Silicon and Tin*; Kumar Das, V. G., Weng, N. G., Gielen, M., Eds.; Oxford University Press: New York, 1992, p 93-109.
70. Freeman, G. G. *Silicones: An Introduction to Their Chemistry and Applications*; The Chapel River Press Ltd.: Andover, Hants, England, 1962.
71. Ritter, K. *Synthesis* **1993**, 735-762.
72. Riggelman, S. L.; DeShong, P. *J. Org. Chem.* **2003**, 68, 8106-8109.
73. Pestunovich, V.; Kirppichenko, S.; Voronkov, M. G. In *The Chemistry of Organic Silicon Compounds*; Rappoport, Z., Apeloig, Y., Eds.; Wiley: Chichester, UK, 1998; Vol. 2, Part 2, Chap. 24, p 1447-1538.
74. Voronkov, M. G. *Pure Appl. Chem.* **1966**, 13, 35-59.
75. Voronkov, M. G.; Yarosh, O. G.; Shchukina, L. V.; Tsetlina, E. O.; Tandura, S. N.; Korotaeva, I. M. *Zh. Obshch. Khim.* **1979**, 49, 614-617.
76. Voronkov, M. G. *Top. Curr. Chem.* **1979**, 84, 77-135.
77. Frye, C. L.; Vincent, G. A.; Finzel, W. A. *J. Am. Chem. Soc.* **1971**, 93, 6805-6811.
78. Verkade, J. G. *Acc. Chem. Res.* **1993**, 26, 483-489.
79. Iwamiya, J. H.; Maciel, G. E. *J. Am. Chem. Soc.* **1993**, 115, 6835-6842.
80. Goodman, L. S.; Hardman, J. G.; Limbird, L. E.; Gilman, A. G. *Goodman and Gilman's The Pharmacological Basis of Therapeutics*; McGraw-Hill: New York, 2001.
81. Mahboobi, S.; Pongratz, H.; Hufsky, H.; Hockemeyer, J.; Frieser, M.; Lyssenko, A.; Paper, D. H.; Burgermeister, J.; Bohmer, F. D.; Fiebig, H. H.; Burger, A. M.; Baasner, S.; Beckers, T. *J. Med. Chem.* **2001**, 44, 4535-4553.
82. Fitzgerald, T. J. *Biochem. Pharmacol.* **1976**, 25, 1383-1387.
83. Rao, K. V.; Cullen, W. P. *Antibiotics Annual 1959-1960*, 950-953.
84. Rao, K. V.; Biemann, R.; Woodward, R. B. *J. Am. Chem. Soc.* **1963**, 85, 2532-2533.

85. Balitz, D. M.; Bush, J. A.; Bradner, W. T.; Doyle, T. W.; O'Herron, F. A.; Nettleton, D. E. *J. Antibiot.* **1982**, *35*, 259-265.
86. Doyle, T. W.; Balitz, D. M.; Grulich, R. E.; Nettleton, D. E. *Tetrahedron Lett.* **1981**, *22*, 4595-4598.
87. Graening, T.; Friedrichsen, W.; Lex, J.; Schmalz, H. G. *Angew. Chem., Int. Ed. Engl.* **2002**, *41*, 1524-1526.
88. Lee, J. C.; Jin, S. J.; Cha, J. K. *J. Org. Chem.* **1998**, *63*, 2804-2805.
89. Schreiber, J.; Threlfall, T.; Eschenmoser, A.; Schudel, P.; Leimgruber, W.; Pesaro, M. *Helv. Chim. Acta* **1961**, *44*, 540-597.
90. Van Tamelen, E.; Spencer, T. A.; Orvis, R. L.; Allen, D. S. *Tetrahedron* **1961**, *14*, 8-34.
91. Scott, A. I.; McCapra, F.; Buchanan, R. L.; Day, A. C.; Young, D. W. *Tetrahedron* **1965**, *21*, 3605-3631.
92. Martel, J.; Toromanoff, E.; Huynh, C. *J. Org. Chem.* **1965**, *30*, 1752-1759.
93. Kato, M.; Kido, F.; Wu, M. D.; Yoshikos. *Bull. Chem. Soc. Jpn.* **1974**, *47*, 1516-1521.
94. Boger, D. L.; Brotherton, C. E. *J. Am. Chem. Soc.* **1986**, *108*, 6713-6719.
95. Nakamura, T.; Murase, Y.; Endo, Y.; Hayashi, R. *Chem. Pharm. Bull.* **1962**, *10*, 281-290.
96. Evans, D. A.; Tanis, S. P.; Hart, D. J. *J. Am. Chem. Soc.* **1981**, *103*, 5813-5821.
97. Banwell, M. G. *Pure Appl. Chem.* **1996**, *68*, 539-542.
98. Banwell, M. G.; Cameron, J. M.; Collis, M. P.; Crisp, G. T.; Gable, R. W.; Hamel, E.; Lambert, J. N.; Mackay, M. F.; Reum, M. E.; Scoble, J. A. *Aust. J. Chem.* **1991**, *44*, 705-728.
99. Weinreb, S. M.; Basha, F. Z.; Hibino, S.; Khatri, N. A.; Kim, D.; Pye, W. E.; Wu, T.-T. *J. Am. Chem. Soc.* **1982**, *104*, 536-544.
100. Kende, A. S.; Lorah, D. P.; Boatman, R. J. *J. Am. Chem. Soc.* **1981**, *103*, 1271-1273.
101. Boger, D. L.; Panek, J. S. *J. Am. Chem. Soc.* **1985**, *107*, 5745-5754.
102. Behforouz, M.; Haddad, J.; Cai, W.; Arnold, M. B.; Mohammadi, F.; Sousa, A. C.; Horn, M. A. *J. Org. Chem.* **1996**, *61*, 6552-6555.
103. Molina, P.; Murcia, F.; Fresneda, P. M. *Tetrahedron Lett.* **1994**, *35*, 1453-1456.
104. Behforouz, M.; Gu, Z.; Cai, W.; Horn, M. A.; Ahmadian, M. *J. Org. Chem.* **1993**, *58*, 7089-7091.
105. Ciafolini, M. A.; Bishop, M. J. *J. Chem. Soc., Chem. Commun.* **1993**, *18*, 1463-1464.

106. Rao, A. V. R.; Chavan, S. P.; Sivadasan, L. *Tetrahedron* **1986**, *42*, 5065-5071.
107. Boger, D. L.; Duff, S. R.; Panek, J. S.; Yasuda, M. *J. Org. Chem.* **1985**, *50*, 5790-5795.
108. Hibino, S.; Okazaki, M.; Ichikawa, M.; Sato, K.; Ishizu, T. *Heterocycles* **1985**, *23*, 261-264.
109. Kende, A. S.; Ebetino, F. H. *Tetrahedron Lett.* **1984**, *25*, 923-926.
110. Banwell, M. G.; Cameron, J. M.; Collis, M. P.; Gravatt, G. L. *Aust. J. Chem.* **1997**, *50*, 395-407.
111. Handy, C. J. Doctoral Dissertation, University of Maryland, College Park, 2002.
112. McElroy, W. T.; DeShong, P. *Org. Lett.* **2003**, *5*, 4779-4782.
113. Godard, A.; Marsais, F.; Ple, N.; Trecort, F.; Turck, A.; Queguener, G. *Heterocycles* **1995**, *40*, 1055-1091.
114. Tamao, K.; Miyaura, N. *Top. Curr. Chem.* **2002**, *219*, 1-9.
115. Schlosser, M. In *Organometallics in Synthesis A Manual*; 2nd ed.; Schlosser, M., Ed.; John Wiley and Sons: New York, NY, 2002, p 1-352.
116. Shibata, K.; Miyazawa, K.; Goto, Y. *J. Chem. Soc., Chem. Commun.* **1997**, *14*, 1309-1310.
117. Mix, A.; Berlekamp, U. H.; Stammler, H.-G.; Neumann, B.; Jutzi, P. *J. Organomet. Chem.* **1996**, *521*, 177-184.
118. Shea, K. J.; Loy, D. A.; Webster, O. *J. Am. Chem. Soc.* **1992**, *114*, 6700-6710.
119. Corriu, R. J. P.; Kpton, A.; Poirier, M.; Royo, G.; Saxce, A. d.; Young, J. C. *J. Organomet. Chem.* **1990**, *395*, 1-26.
120. Selin, T. G.; West, R. *J. Am. Chem. Soc.* **1962**, *84*, 1856-1859.
121. Chappelow, C. C.; Elliot, R. L.; Goodwin, J. T. *J. Org. Chem.* **1960**, *25*, 435-439.
122. Gilman, H.; Brannen, C. *J. Am. Chem. Soc.* **1951**, *73*, 4640-4641.
123. Brown, H. C.; Cole, T. E. *Organometallics* **1983**, *2*, 1316-1319.
124. Wakefield, B. J. *Organomagnesium Methods in Organic Synthesis*; Academic Press, Inc.: San Diego, CA, 1995.
125. Raston, C. L.; Salem, G. In *The Chemistry of the Metal-Carbon Bond*; Hartley, F. R., Ed.; John Wiley and Sons: Chichester, 1987; Vol. 4, p 159-306.
126. Wardell, J. L. In *The Chemistry of the Metal-Carbon Bond*; Hartley, F. R., Ed.; John Wiley and Sons: Chichester, 1987; Vol. 4, p 1-158.
127. Wakefield, B. J. *The Chemistry of Organolithium Compounds*; 1st ed.; Pergamon Press: Oxford, 1974.

128. Gilman, H.; Morton, J. W., Jr. In *Organic Reactions*; Adams, R., Ed.; John Wiley & Sons, Inc.: New York, 1954; Vol. 8.
129. Jones, R. G.; Gilman, H. In *Organic Reactions*; Adams, R., Ed.; John Wiley & Sons, Inc.: New York, 1951; Vol. 6.
130. Blomberg, C. *The Barbier Reaction and Related One-Step Processes*; 1st ed.; Springer-Verlag: Heidelberg, 1993.
131. Snieckus, V. *Chem. Rev.* **1990**, *90*, 879-933.
132. Beak, P.; Kerrick, S. T.; Gallagher, D. J. *J. Am. Chem. Soc.* **1993**, *115*, 10628-10636.
133. Beak, P.; Meyers, A. I. *Acc. Chem. Res.* **1986**, *19*, 356-363.
134. Gallagher, D. J.; Beak, P. *J. Org. Chem.* **1995**, *60*, 7092-7093.
135. Betz, J.; Bauer, W. *J. Am. Chem. Soc.* **2002**, *124*, 8699-8706.
136. Kremer, T.; Junge, M.; Schleyer, P. V. *Organometallics* **1996**, *15*, 3345-3359.
137. Han, J. W.; Son, S. U.; Chung, Y. K. *J. Org. Chem.* **1997**, *62*, 8264-8267.
138. Stille, J. K. *Angew. Chem., Int. Ed. Engl.* **1986**, *25*, 508-523.
139. Hassan, J.; Sevignon, M.; Gozzi, C.; Schulz, E.; Lemaire, M. *Chem. Rev.* **2002**, *102*, 1359-1469.
140. Sessler, J. L.; Sathiosatham, M.; Doerr, K.; Lynch, V.; Abboud, K. A. *Angew. Chem., Int. Ed. Engl.* **2000**, *39*, 1300-1303.
141. Davies, A. G.; Smith, P. J. In *Comprehensive Organometallic Chemistry*; Wilkinson, G., Stone, F. G. A., Abel, E. W., Eds.; Pergamon Press: Oxford, 1982; Vol. 2, p 519, Chapt. 11.
142. Pereyre, M.; Quintard, J.-P.; Rahm, A. *Tin in Organic Synthesis*; Butterworths: London, 1987.
143. Fugami, K.; Kosugi, M. *Top. Curr. Chem.* **2002**, *219*, 87-130.
144. Azizian, H.; Eaborn, C.; Pidcock, A. *J. Organomet. Chem.* **1981**, *215*, 49-58.
145. Murata, M.; Watanabe, S.; Masuda, Y. *Synlett* **2000**, 1043-1045.
146. Rossi, R. A.; Pierini, A. B.; Penenory, A. B. *Chem. Rev.* **2003**, *103*, 71-167.
147. Gielen, M. *Rev. Silicon Germanium Tin Lead Compd.* **1981**, *5*, 5-152.
148. Gielen, M.; de Poorter, B. *Rev. Silicon Germanium Tin Lead Compd.* **1977**, *3*, 9-144.
149. Córscico, E. F.; Rossi, R. A. *Synlett* **2000**, 230-232.
150. Jousseume, B. *J. Chem. Soc., Chem. Commun.* **1984**, 1452-1453.

151. Yammal, C. C.; Podesta, J. C.; Rossi, R. A. *J. Org. Chem.* **1992**, *57*, 5720-5725.
152. Jousseau, B.; Villeneuve, P. *Tetrahedron* **1989**, *45*, 1145-1154.
153. Martin, A. R.; Yang, Y. *Acta Chem. Scand.* **1993**, *47*, 221-230.
154. Miyaura, N. *Top. Curr. Chem.* **2002**, *219*, 11-59.
155. Matteson, D. S. In *The Chemistry of the Metal-Carbon Bond*; Hartley, F. R., Ed.; John Wiley and Sons: Chichester, 1987; Vol. 4, p 307-402.
156. Letsinger, R. L.; Dandegaonker, S. H. *J. Am. Chem. Soc.* **1959**, *81*, 498-501.
157. Brindley, P. B.; Gerrard, W.; Lappert, M. F. *J. Chem. Soc.* **1955**, 2956-2958.
158. Prim, D.; Campagne, J. M.; Joseph, D.; Andrioletti, B. *Tetrahedron* **2002**, *58*, 2041-2075.
159. Marshall, J. A. *Chem. Rev.* **2000**, *100*, 3163-3185.
160. Ishiyama, T.; Miyaura, N. *J. Organomet. Chem.* **2000**, *611*, 392-402.
161. Ishiyama, T.; Murata, M.; Miyaura, N. *J. Org. Chem.* **1995**, *60*, 7508-7510.
162. Zhu, L.; Duquette, J.; Zhang, M. B. *J. Org. Chem.* **2003**, *68*, 3729-3732.
163. Ishiyama, T.; Ishida, K.; Miyaura, N. *Tetrahedron* **2001**, *57*, 9813-9816.
164. Furstner, A.; Seidel, G. *Org. Lett.* **2002**, *4*, 541-543.
165. Ishiyama, T.; Itoh, Y.; Kitano, T.; Miyaura, N. *Tetrahedron Lett.* **1997**, *38*, 3447-3450.
166. Abraham, M. H.; Grellier, P. L. In *The Chemistry of the Metal-Carbon Bond*; Hartley, F. R., Patai, S., Eds.; Wiley: New York, 1985; Vol. 2.
167. Willis, D. M.; Strongin, R. M. *Tetrahedron Lett.* **2000**, *41*, 8683-8686.
168. Murata, M.; Watanabe, S.; Masuda, Y. *J. Org. Chem.* **1997**, *62*, 6458-6459.
169. Murata, M.; Oyama, T.; Watanabe, S.; Masuda, Y. *J. Org. Chem.* **2000**, *65*, 164-168.
170. Baudoin, O.; Guenard, D.; Gueritte, F. *J. Org. Chem.* **2000**, *65*, 9268-9271.
171. Doux, M.; Mezailles, N.; Melaimi, M.; Ricard, L.; Le Floch, P. *Chem. Commun.* **2002**, 1566-1567.
172. Euzenat, L.; Horhant, D.; Ribourdouille, Y.; Duriez, C.; Alcaraz, G.; Vaultier, M. *Chem. Commun.* **2003**, 2280-2281.
173. Song, Y. L.; Morin, C. *Synlett* **2001**, *2*, 266-268.
174. Ishiyama, T.; Miyaura, N. *J. Organomet. Chem.* **2003**, *680*, 3-11.

175. Davies, M. W.; Johnson, C. N.; Harrity, J. P. A. *J. Org. Chem.* **2001**, *66*, 3525-3532.
176. Takagi, J.; Sato, K.; Hartwig, J. F.; Ishiyama, T.; Miyaura, N. *Tetrahedron Lett.* **2002**, *43*, 5649-5651.
177. Hatanaka, Y.; Fukushima, S.; Hiyama, T. *Chem. Lett.* **1989**, 1711-1714.
178. Hiyama, T.; Shirakawa, E. *Top. Curr. Chem.* **2002**, *219*, 62-85.
179. Hatanaka, Y.; Fukushima, S.; Hiyama, T. *Heterocycles* **1990**, *30*, 303-306.
180. Hatanaka, Y.; Hiyama, T. *Tetrahedron Lett.* **1990**, *31*, 2719-2722.
181. Hatanaka, Y.; Fukushima, S.; Hiyama, T. *Tetrahedron* **1992**, *48*, 2113-2126.
182. Damrauer, R.; Danahey, S. E. *Organometallics* **1986**, *5*, 1490-1494.
183. Yen, V. K.; Papouskova, Z.; Schraml, J.; Chvalovsky, V. *Collect. Czech. Chem. Commun.* **1973**, *38*, 3167-3175.
184. Farooq, O. *J. Organomet. Chem.* **2000**, *613*, 239-243.
185. Corriu, R. J. P.; Fernandez, J. M.; Guerin, C. *J. Organomet. Chem.* **1980**, *192*, 347-352.
186. Ohmura, H.; Matsushashi, H.; Tanaka, M.; Kuroboshi, M.; Hiyama, T.; Hatanaka, Y.; Goda, K.-i. *J. Organomet. Chem.* **1995**, *499*, 167-71.
187. Yarosh, O. G.; Burnashova, T. D.; Voronkov, M. G. *Bull. Acad. Sci. USSR Div. Chem. Sci. (Engl. Transl.)* **1987**, *36*, 1030-1031.
188. Marans, N. S.; Sommer, L. H.; Whitmore, F. C. *J. Am. Chem. Soc.* **1951**, *73*, 5127-5130.
189. Boyer, J.; Breliere, C.; Carre, F.; Corriu, R. J. P.; Kpoton, A.; Poirier, M.; Royo, G.; Young, J. C. *J. Chem. Soc., Dalton Trans.* **1989**, 43-51.
190. Kunai, A.; Sakurai, T.; Toyoda, E.; Ishikawa, M. *Organometallics* **1996**, *15*, 2478-2482.
191. Smit, C. N.; Bickelhaupt, F. *Organometallics* **1987**, *6*, 1156-1163.
192. Unno, M.; Masuda, H.; Matsumoto, H. *Bull. Chem. Soc. Jpn.* **1998**, *71*, 2449-2458.
193. Jutzi, P.; Kanne, D.; Hursthouse, M.; Howes, A. J. *Chem. Ber.* **1988**, *121*, 1299-1305.
194. Nakadaira, Y.; Oharu, K.; Sakurai, H. *J. Organomet. Chem.* **1986**, *309*, 247-256.
195. Hyde, J. F.; DeLong, R. C. *J. Am. Chem. Soc.* **1941**, *63*, 1194-1196.
196. Rich, J. D. *J. Am. Chem. Soc.* **1989**, *111*, 5886-5893.

197. Matsumoto, H.; Nagashima, S.; Yoshihiro, K.; Nagai, Y. *J. Organomet. Chem.* **1975**, *85*, C1-C3.
198. Cros, S.; Bennetau, B.; Dunogues, J.; Babin, P. *J. Organomet. Chem.* **1994**, *468*, 69-74.
199. Qiu, H.; Feng, S.; Chen, J.; Du, Z. *Phosphorus, Sulfur Silicon Relat. Elem.* **1990**, *47*, 325-326.
200. Chadha, R. K.; Drake, J. E.; Neo, M. K. H. *J. Organomet. Chem.* **1984**, *277*, 47-52.
201. Bochkarev, V. N.; Turetskaya, R. A.; Troitskaya, N. N.; Luskina, B. M.; Savushkina, V. I.; Korablina, T. P.; Dzvonar, V. G.; Chernysheva, N. I. *Zh. Obshch. Khim.* **1983**, *53*, 824-827.
202. Bogovtseva, L. P.; Vainshtein, B. I.; Krasnova, T. L.; Rogachevskii, V. L.; Chernyshev, E. A. *Zh. Obshch. Khim.* **1978**, *48*, 1370-1373.
203. Rochow, E. G.; Gilliam, W. F. *J. Am. Chem. Soc.* **1945**, *67*, 1772-1773.
204. Brook, M. A. *Silicon in Organic, Organometallic, and Polymer Chemistry*, John Wiley & Sons, Inc.: New York, 2000.
205. Minge, O.; Mitzel, N. W.; Schmidbaur, H. *Organometallics* **2002**, *21*, 680-684.
206. Rosenberg, S. D.; Walburn, J. J.; Ramsden, H. E. *J. Org. Chem.* **1957**, *22*, 1606-1607.
207. Lewis, D. W. *J. Org. Chem.* **1958**, *23*, 1893-1895.
208. Breed, L. W.; Haggerty, W. J. *J. Org. Chem.* **1960**, *25*, 126-128.
209. Breslow, R.; Heyer, D. *J. Am. Chem. Soc.* **1982**, *104*, 2045-2046.
210. Rubinsztajn, S.; Zeldin, M.; Fife, W. K. *Synth. React. Inorg. Met.-Org. Chem.* **1990**, *20*, 495-502.
211. Kuhn, N.; Laarz, W.; Schulten, M.; Boese, R.; Blaser, D.; Brett, W. A.; Stellberg, P. *Z. Naturforsch., B: Chem. Sci.* **1992**, *47*, 1233-1240.
212. Auner, N.; Probst, R.; Hahn, F.; Herdtweck, E. *J. Organomet. Chem.* **1993**, *459*, 25-41.
213. Belzner, J.; Schar, D.; Herbst-Irmer, R.; Kneisel, B. O.; Noltemeyer, M. *Tetrahedron* **1998**, *54*, 8481-8500.
214. Corriu, R. J. P.; Mix, A.; Lanneau, F. G. *J. Organomet. Chem.* **1998**, *570*, 183-193.
215. Cerveau, G.; Chappellet, S.; Corriu, R. J. P.; Dabiens, B. *J. Organomet. Chem.* **2001**, *626*, 92-99.
216. Bezombes, J. P.; Chuit, C.; Corriu, R. J. P.; Reye, C. *J. Mater. Chem.* **1998**, *8*, 1749-1759.
217. Post, H. W.; Norton, H. M. *J. Org. Chem.* **1942**, *7*, 528-533.

218. Corriu, R. J. P.; Granier, M.; Lanneau, G. F. *J. Organomet. Chem.* **1998**, *562*, 79-88.
219. Tacke, R.; Bentlage-Felten, A.; Linoh, H.; Magda, S. *Z. Naturforsch., B: Anorg. Chem. Org. Chem.* **1986**, *41B*, 649-654.
220. Frohn, H. J.; Giesen, M.; Klose, A.; Lewin, A.; Bardin, V. V. *J. Organomet. Chem.* **1996**, *506*, 155-64.
221. Murata, M.; Suzuki, K.; Watanabe, S.; Masuda, Y. *J. Org. Chem.* **1997**, *62*, 8569-8571.
222. Colvin, E. W. In *The Chemistry of the Metal-Carbon Bond*; Hartley, F. R., Ed.; John Wiley and Sons: Chichester, 1987; Vol. 4, p 539-621.
223. Petrov, A. D.; Mironov, B. F.; Ponomarenko, V. A.; Chernyshev, E. A. *Synthesis of Organosilicon Monomers*; Consultants Bureau: New York, 1964.
224. Jacob, S.; Popall, M.; Froehlich, L.; Kahlenberg, F.; Olma, K.; Fraunhofer-Gesellschaft zur Foerderung der Angewandten Forschung e.V., Germany: Denmark Patent 10159859, 2001, see *Chem Abstr.* **2003**, *138*, 899915.
225. Pak, J. J.; Greaves, J.; McCord, D. J.; Shea, K. J. *Organometallics* **2002**, *21*, 3552-3561.
226. Kano, N.; Komatsu, F.; Kawashima, T. *J. Am. Chem. Soc.* **2001**, *123*, 10778-10779.
227. Riedmiller, F.; Jockisch, A.; Schmidbaur, H. *Organometallics* **1998**, *17*, 4444-4453.
228. Ahn, C.; Manoso, A. S.; Correia, R.; Soheili, A.; DeShong, P. unpublished results.
229. Correia, R. Doctoral Dissertation, University of Maryland, College Park, 2002.
230. French, H. E.; Sears, K. *J. Am. Chem. Soc.* **1951**, *73*, 469-470.
231. Fischer, F. C.; Havinga, E. *Recl. Trav. Chim. Pays-Bas* **1965**, *84*, 439-439.
232. Taylor, E. W.; Nikam, S. S.; Lambert, G.; Martin, A. R.; Nelson, D. L. *Mol. Pharmacol.* **1988**, *34*, 42-53.
233. Corriu, R. J. P.; Guérin, C.; Moreau, J. J. E. *Top. Stereochem.* **1984**, *15*, 43-198.
234. Wolfe, J. P.; Buchwald, S. L. *Angew. Chem., Int. Ed. Engl.* **1999**, *38*, 2413-2415.
235. Wolfe, J. P.; Singer, R. A.; Yang, B. H.; Buchwald, S. L. *J. Am. Chem. Soc.* **1999**, *121*, 9550-9561.
236. Yang, B. H.; Buchwald, S. L. *J. Organomet. Chem.* **1999**, *576*, 125-146.
237. Old, D. W.; Wolfe, J. P.; Buchwald, S. L. *J. Am. Chem. Soc.* **1998**, *120*, 9722-9723.
238. Aranyos, A.; Old, D. W.; Kiyomori, A.; Wolfe, J. P.; Sadighi, J. P.; Buchwald, S. L. *J. Am. Chem. Soc.* **1999**, *121*, 4369-4378.

239. Littke, A. F.; Fu, G. C. *Angew. Chem., Int. Ed. Engl.* **1998**, *37*, 3387-3388.
240. Utimoto, K.; Otake, Y.; Yoshino, H.; Kuwahara, E.; Oshima, K.; Matsubara, S. *Bull. Chem. Soc. Jpn.* **2001**, *74*, 753-754.
241. Haebich, D.; Effenberger, F. *Synthesis* **1978**, 755-756.
242. Eaborn, C.; Walton, D. R. M.; Young, D. J. *J. Chem. Soc. B* **1969**, 15-20.
243. Benkeser, R. A.; Hickner, R. A.; Hoke, D. I. *J. Am. Chem. Soc.* **1958**, *80*, 2279-2282.
244. Benkeser, R. A.; Krysiak, H. R. *J. Am. Chem. Soc.* **1954**, *76*, 6353-6357.
245. Brook, M. A.; Henry, C. *Tetrahedron* **1996**, *52*, 861-868.
246. Effenberger, F.; Spiegler, W. *Chem. Ber.* **1985**, *118*, 3872-3899.
247. Seconi, G.; Taddei, M.; Eaborn, C.; Stamper, J. G. *J. Chem. Soc., Perkin Trans. 2* **1982**, 643-646.
248. Szele, I. *Helv. Chim. Acta* **1981**, *64*, 2733-2737.
249. Penalva, V.; Hassan, J.; Lavenot, L.; Gozzi, C.; Lemaire, M. *Tetrahedron Lett.* **1998**, *39*, 2559-2560.
250. Hassan, J.; Penalva, V.; Lavenot, L.; Gozzi, C.; Lemaire, M. *Tetrahedron* **1998**, *54*, 13793-13804.
251. Torii, S.; Tanaka, H.; Morisaki, K. *Tetrahedron Lett.* **1985**, *26*, 1655-1658.
252. Kotsuki, H.; Datta, P. K.; Hayakawa, H.; Suenaga, H. *Synthesis* **1995**, 1348-1350.
253. Echavarren, A. M.; Stille, J. K. *J. Am. Chem. Soc.* **1988**, *110*, 1557-1565.
254. Baillargeon, V. P.; Stille, J. K. *J. Am. Chem. Soc.* **1986**, *108*, 452-461.
255. Boukherroub, R.; Chatgililoglu, C.; Manuel, G. *Organometallics* **1996**, *15*, 1508-1510.
256. Benkeser, R. A.; Gaul, J. M.; Smith, W. E. *J. Am. Chem. Soc.* **1969**, *91*, 3666-3667.
257. Hatanaka, Y.; Hiyama, T. *Tetrahedron Lett.* **1987**, *28*, 4715-4718.
258. Kunai, A.; Sakurai, T.; Toyoda, E.; Ishikawa, M.; Yamamoto, Y. *Organometallics* **1994**, *13*, 3233-3236.
259. Atwell, W.; Bokerman, G.; Dow Corning Corp.: U.S. Patent 3772347, 1971, see *Chem Abstr.* **1973**, *44*, 66560.
260. Atwell, W.; Bokerman, G.; Dow Corning Corp.: U.S. Patent 3746732, 1971, see *Chem Abstr.* **1973**, *79*, 66585.

261. Matsumoto, H.; Yoshihiro, K.; Nagashima, S.; Watanabe, H.; Nagai, Y. *J. Organomet. Chem.* **1977**, *128*, 409-413.
262. Matsumoto, H.; Yako, T.; Nagashima, S.; Motegi, T.; Nagai, Y. *J. Organomet. Chem.* **1978**, *148*, 97-106.
263. Matsumoto, H.; Shono, K.; Nagai, Y. *J. Organomet. Chem.* **1981**, *208*, 145-152.
264. Eaborn, C.; Griffiths, R. W.; Pidcock, A. *J. Organomet. Chem.* **1982**, *225*, 331-341.
265. Calas, R.; Dunogues, J.; Deleris, G.; Duffaut, N. *J. Organomet. Chem.* **1982**, *225*, 117-130.
266. Babin, P.; Bennetau, B.; Theurig, M.; Dunogues, J. *J. Organomet. Chem.* **1993**, *446*, 135-138.
267. Goossen, L. J.; Ferwanah, A. R. S. *Synlett* **2000**, 1801-1803.
268. Viciu, M. S.; Grasa, G. A.; Nolan, S. P. *Organometallics* **2001**, *20*, 3607-3612.
269. Rich, J. D. *Organometallics* **1989**, *8*, 2609-2615.
270. Rich, J. D.; Krafft, T. E. *Organometallics* **1990**, *9*, 2040-2045.
271. Manoso, A. S.; DeShong, P. *J. Org. Chem.* **2001**, *66*, 7449-7455.
272. Murata, M.; Ishikura, M.; Nagata, M.; Watanabe, S.; Masuda, Y. *Org. Lett.* **2002**, *4*, 1843-1845.
273. Still, W. C.; Kahn, M.; Mitra, A. *J. Org. Chem.* **1978**, *42*, 2923-2924.
274. Perrin, D. D.; Armarego, W. L. F.; Perrin, D. R. *Purification of Laboratory Chemicals*; 2 ed.; Pergamon: New York, 1980.
275. Bjornestedt, R.; Zhong, G.; Lerner, R. A.; Barbas, C. F., III *J. Am. Chem. Soc.* **1996**, *118*, 11720-11724.
276. Davies, S. G.; Mobbs, B. E. *J. Chem. Soc., Perkin Trans. 1* **1987**, 2597-2604.
277. Corcoran, R. C.; Bang, S. H. *Tetrahedron Lett.* **1990**, *31*, 6757-6758.
278. Coudret, C. *Synth. Commun.* **1996**, *26*, 3543-3547.
279. Young, T. E.; Amstutz, E. D. *J. Am. Chem. Soc.* **1951**, *73*, 4773-4775.
280. Balicki, R.; Kozłowska, M.; Sobotka, W. *Bull. Pol. Acad. Sci.-Chem.* **1986**, *34*, 281-287.
281. Kunishima, M.; Friedman, J. E.; Rokita, S. E. *J. Am. Chem. Soc.* **1999**, *121*, 4722-4723.
282. Olah, G. A.; Narang, S. C.; Balaram Gupta, B. G.; Malhotra, R. *J. Org. Chem.* **1979**, *44*, 1247-1251.
283. Schleyer, P. v. R. In *Reagents for Organic Synthesis*; Fieser, L. F., Fieser, M., Eds.; John Wiley and Sons: New York, 1967; Vol. 1, p 1179-1184.

284. Wawzonek, S.; Klimstra, P. D.; Kallio, R. E. *J. Org. Chem.* **1960**, *25*, 621-623.
285. Pilcher, A. S.; Ammon, H. L.; DeShong, P. *J. Am. Chem. Soc.* **1995**, *117*, 5166-5167.
286. Kofron, W. G.; Baclawski, L. M. *J. Org. Chem.* **1976**, *41*, 1879-1880.

CHAPTER TWO

1. Tandura, S. N.; Voronkov, M. G.; Alekseev, N. V. *Top. Curr. Chem.* **1986**, 99-189.
2. Diltthey, W. *Chem. Ber.* **1903**, *36*, 923, 1595, 3207.
3. Diltthey, W. *Liebigs Ann. Chem.* **1906**, *344*, 300-300.
4. Rosenheim, A. V. A. *Chem. Ber.* **1903**, *36*, 1833-1833.
5. Armitage, D. A. In *Comprehensive Organometallic Chemistry II: A Review of the Literature 1982-1994*; Wilkinson, G., Stone, F. G. A., Abel, E. W., Davies, A. G., Eds.; Pergamon: Oxford, 1982; Vol. 2, Chap. 1.
6. Armitage, D. A. In *Comprehensive Organometallic Chemistry*; Wilkinson, G., Stone, F. G. A., Abel, E. W., Eds.; Pergamon: Oxford, 1995; Vol. 2, Chap. 9.
7. Voronkov, M. G. In *Biochemistry of Silicon and Related Problems*; Bendz, G., Lindqvist, I., Eds.; Plenum: New York, 1978, p 395-591.
8. Voronkov, M. G. *Top. Curr. Chem.* **1979**, *84*, 77-135.
9. Pestunovich, V.; Kirppichenko, S.; Voronkov, M. G. In *The Chemistry of Organic Silicon Compounds*; Rappoport, Z., Apeloig, Y., Eds.; Wiley: Chichester, UK, 1998; Vol. 2, Part 2, Chap. 24, p 1447-1538.
10. Voronkov, M. G. *Pure Appl. Chem.* **1966**, *13*, 35-59.
11. Voronkov, M. G.; Yarosh, O. G.; Shchukina, L. V.; Tsetlina, E. O.; Tandura, S. N.; Korotaeva, I. M. *Zh. Obshch. Khim.* **1979**, *49*, 614-617.
12. Frye, C. L.; Vincent, G. A.; Finzel, W. A. *J. Am. Chem. Soc.* **1971**, *93*, 6805-6811.
13. Verkade, J. G. *Acc. Chem. Res.* **1993**, *26*, 483-489.
14. Shklover, V. E.; Struchkov, Y. T.; Voronkov, M. G. *Russ. Chem. Rev.* **1989**, *58*, 211-240.
15. Voronkov, M. G.; Brodskaya, E. I.; Belyaeva, V. V.; Lazareva, N. F. *Russ. Chem. Bull.* **2001**, *50*, 757-763.
16. Voronkov, M. G. *Bull. Acad. Sci. USSR Div. Chem. Sci. (Engl. Transl.)* **1991**, *40*, 2319-2334.

17. Voronkov, M. G.; Pukhnarevich, V. B. *Bull. Acad. Sci. USSR Div. Chem. Sci. (Engl. Transl.)* **1982**, *31*, 939-957.
18. Voronkov, M. G.; Baryshok, V. P. *J. Organomet. Chem.* **1982**, *239*, 199-249.
19. Voronkov, M. G.; Dyakov, V. M.; Kirpichenko, S. V. *J. Organomet. Chem.* **1982**, *233*, 1-147.
20. Chu, H. K.; Johnson, M. D.; Frye, C. L. *J. Organomet. Chem.* **1984**, *271*, 327-336.
21. Sommer, L. H.; Frye, C. L.; Korte, W. D. *J. Am. Chem. Soc.* **1972**, *94*, 3463-3469.
22. Sommer, L. H.; Parker, G. A.; Lloyd, N. C.; Frye, C. L.; Michael, K. W. *J. Am. Chem. Soc.* **1967**, *89*, 857-861.
23. Frye, C. L.; Vincent, G. A.; Hauschil, G. I. *J. Am. Chem. Soc.* **1966**, *88*, 2727-2730.
24. Sommer, L. H.; Frye, C. L.; Parker, G. A. *J. Am. Chem. Soc.* **1964**, *86*, 3280-3283.
25. Sommer, L. H.; Frye, C. L.; Parker, G. A. *J. Am. Chem. Soc.* **1964**, *86*, 3276-3279.
26. Sommer, L. H.; Michael, K. W.; Frye, C. L.; Parker, G. A. *J. Am. Chem. Soc.* **1964**, *86*, 3271-3276.
27. Sommer, L. H.; Frye, C. L.; Citron, J. D. *J. Am. Chem. Soc.* **1964**, *86*, 5684-5685.
28. Frye, C. L. *J. Am. Chem. Soc.* **1964**, *86*, 3170-3170.
29. Sommer, L. H.; Okaya, Y.; Parker, G. A.; Michael, K. W.; Musolf, M. C.; Rodewald, P. G.; Frye, C. L.; Pepinsky, R. *J. Am. Chem. Soc.* **1961**, *83*, 2210-2212.
30. Frye, C. L.; Hall, J. A.; Vogel, G. E. *J. Am. Chem. Soc.* **1961**, *83*, 996-997.
31. Sommer, L. H.; Frye, C. L. *J. Am. Chem. Soc.* **1960**, *82*, 3796-3796.
32. Sommer, L. H.; Frye, C. L. *J. Am. Chem. Soc.* **1960**, *82*, 4118-4119.
33. Sommer, L. H.; Frye, C. L. *J. Am. Chem. Soc.* **1959**, *81*, 1013-1013.
34. Lukevics, E.; Pudova, O.; Sturkovich, R. *Molecular Structure of Organosilicon Compounds*; Ellis Horwood Limited: Chichester, 1989.
35. Abele, E.; Lukevics, E. *Main Group Met. Chem.* **2001**, *24*, 315-350.
36. Lukevics, E.; Dzintara, M. *J. Organomet. Chem.* **1985**, *295*, 265-315.
37. Lukevics, E.; Pudova, O. *Main Group Met. Chem.* **1998**, *21*, 123-183.
38. Lukevics, E.; Pudova, O. *Main Group Met. Chem.* **1998**, *21*, 649-727.
39. Lukevics, E.; Pudova, O. *Main Group Met. Chem.* **1999**, *22*, 385-403.
40. Lukevics, E.; Pudova, O. *Main Group Met. Chem.* **2000**, *23*, 207-231.
41. Lukevics, E.; Pudova, O. A. *Khim. Geterotsikl. Soedin.* **1996**, 1605-1646.

42. Chuit, C.; Corriu, R. P. J.; Reye, C.; Young, J. C. *Chem. Rev.* **1993**, *93*, 1371-1448.
43. Corriu, R. J. P.; Young, J. C. In *The Silicon-Heteroatom Bond*; Patai, S., Rappoport, Z., Eds.; John Wiley & Sons: New York, 1991, Chap. 1.
44. Corriu, R. J. P.; Guérin, C.; Moreau, J. J. E. *Top. Stereochem.* **1984**, *15*, 43-198.
45. Corriu, R. J. P.; Guérin, C. *Adv. Organomet. Chem.* **1982**, *20*, 265-312.
46. Corriu, R. J. P.; Guérin, C. *J. Organomet. Chem.* **1980**, *198*, 231-320.
47. Pilcher, A. S.; DeShong, P. *J. Org. Chem.* **1996**, *61*, 6901-6905.
48. Pilcher, A. S.; Ammon, H. L.; DeShong, P. *J. Am. Chem. Soc.* **1995**, *117*, 5166-5167.
49. Handy, C. J.; Lam, Y. F.; DeShong, P. *J. Org. Chem.* **2000**, *65*, 3542-3543.
50. Mowery, M. E.; DeShong, P. *J. Org. Chem.* **1999**, *64*, 3266-3270.
51. Brescia, M. R.; DeShong, P. *J. Org. Chem.* **1998**, *63*, 3156-3157.
52. Soli, E. D.; Manoso, A. S.; Patterson, M. C.; DeShong, P.; Favor, D. A.; Hirschmann, R.; Smith, A. B. *J. Org. Chem.* **1999**, *64*, 3171-3177.
53. Soli, E. D.; Manoso, A. S.; Patterson, M. C.; DeShong, P.; Favor, D. A.; Hirschmann, R.; Smith, A. B. *J. Org. Chem.* **1999**, *64*, 6526-6526.
54. Soli, E. D.; DeShong, P. *J. Org. Chem.* **1999**, *64*, 9724-9726.
55. Pilcher, A. S. Doctoral Dissertation, University of Maryland, College Park, 1995.
56. Brook, M. A. *Silicon in Organic, Organometallic, and Polymer Chemistry*; John Wiley & Sons, Inc.: New York, 2000.
57. Sanderson, R. T. *J. Am. Chem. Soc.* **1983**, *105*, 2259-2261.
58. Day, M. C. J.; Selbin, J. In *Theoretical Inorganic Chemistry*; Reinhold: New York, 1969.
59. Moore, C. E. In *Ionization Potentials and Ionization Limits Derived from the Analysis of Optical Spectra*; NSRDS-NBS 34: National Bureau of Standards: Washington, D. C., 1969.
60. Corey, E. J. In *The Chemistry of Organic Silicon Compounds*; Patai, S., Rappoport, Z., Eds.; Wiley: Chichester, UK, 1989; Vol. 1, Part 1, Chap. 1, p 3-56.
61. Cotton, F. A.; Wilkinson, G. *Advanced Inorganic Chemistry*, 5th ed.; Wiley: New York, 1988.
62. Allred, A. L.; E., R. *J. Inorg. Nucl. Chem.* **1958**, *5*, 264-268.
63. Luke, B. T.; Pople, J. A.; Krogh-Jespersen, M.-B.; Apeloig, Y.; Chandraskhar; Schleyer, P. v. R. *J. Am. Chem. Soc.* **1986**, *108*, 260-269.

64. Apeloig, Y. In *The Chemistry of Organic Silicon Compounds*; Patai, S., Rappoport, Z., Eds.; Wiley: Chichester, UK, 1989; Vol. 1, Part 1, Chap. 2, p 57-226.
65. Dewar, M. J. S.; Healy, E. F.; Stewart, J. J. P.; Friedheim, J.; Grady, G. *Organometallics* **1986**, *5*, 375-379.
66. Colvin, E. W. *Silicon in Organic Synthesis*; Butterworths: London, 1981.
67. Kaftory, M.; Kapon, M.; Botoshansky, M. In *The Chemistry of Organic Silicon Compounds*; Rappoport, Z., Apeloig, Y., Eds.; Wiley: Chichester, UK, 1998; Vol. 2, Part 1, Chap. 5, p 181-266.
68. Sheldrick, W. S. In *The Chemistry of Organic Silicon Compounds*; Patai, S., Rappoport, Z., Eds.; Wiley: Chichester, UK, 1989; Vol. 1, Part 1, Chap. 3, p 227-304.
69. Maryanoff, C. A.; Maryanoff, B. E. In *Asym. Synth.*; Morrison, J. D., Ed.; Academic: New York, 1984; Vol. 4, p 355-374.
70. Djerourou, A.-H.; Blanco, L. *Tetrahedron Lett.* **1991**, *32*, 6325-6326.
71. Fukui, T.; Kawamoto, T.; Tanaka, A. *Tetrahedron: Asymmetry* **1994**, *5*, 73-82.
72. Huheey, J. E. *Inorganic Chemistry*; 3rd ed.; Harper and Row: New York, 1983.
73. Bent, H. A. *J. Chem. Phys.* **1960**, *33*, 1259-1260.
74. Bent, H. A. *Chem. Rev.* **1961**, *61*, 275-311.
75. Bent, H. A. *J. Chem. Phys.* **1960**, *33*, 1260-1261.
76. Boudin, A.; Cerveau, G.; Chuit, C.; Corriu, R. J. P.; Reyé, C. *Organometallics* **1988**, *7*, 1165-1171.
77. Pommier, J. C. *Rev. Silicon Germanium Tin Lead Compd.* **1979**, *4*, 91-149.
78. Zheng, J.-Y.; Konishi, K.; Aida, T. *Chem. Lett.* **1998**, 453-454.
79. Kane, K. M.; Lorenz, C. R.; Heilman, D. M.; Lemke, F. R. *Inorg. Chem.* **1998**, *37*, 669-673.
80. Kane, K. M.; Lemke, F. R.; Peterson, J. R. *Inorg. Chem.* **1995**, *34*, 4085-4091.
81. Marks, T. J. *Science* **1985**, *227*, 881-889.
82. Deiters, J. A.; Holmes, R. R. *J. Am. Chem. Soc.* **1990**, *112*, 7197-7202.
83. Kleboth, K.; Rode, B. M. *Monatsh. Chem.* **1974**, *105*, 815-821.
84. Boudin, A.; Cerveau, G.; Chuit, C.; Corriu, R. J. P. *Angew. Chem., Int. Ed. Engl.* **1986**, *25*, 473-474.
85. Birkofer, L.; Stuhl, O. In *The Chemistry of Organic Silicon Compounds*; Patai, S., Rappoport, Z., Eds.; Wiley: Chichester, UK, 1989; Vol. 1, Part 1, Chap. 10, p 655-762.

86. Lehn, J. M.; Sauvage, J. P. *J. Am. Chem. Soc.* **1975**, *97*, 6700-6707.
87. Laine, R. M.; Blohowiak, K. Y.; Robinson, T. R.; Hoppe, M. L.; Nardi, P.; Kampf, J.; Uhm, J. *Nature* **1991**, *353*, 642-644.
88. Kansal, P.; Laine, R. M. *J. Am. Ceram. Soc.* **1994**, *77*, 875-882.
89. Iwamiya, J. H.; Maciel, G. E. *J. Am. Chem. Soc.* **1993**, *115*, 6835-6842.
90. Smith, A. L. *The Analytical Chemistry of Silicones*; Wiley: New York, 1991; Vol. 112.
91. Taylor, R. B.; Parbhoo, B.; Fillmore, D. M. In *The Analytical Chemistry of Silicones*; Wiley: New York, 1991; Vol. 112.
92. Takeuchi, Y.; Takayama, T. In *The Chemistry of Organic Silicon Compounds*; Rappoport, Z., Apeloig, Y., Eds.; Wiley: Chichester, U. K., 1998; Vol. 2, Part 1, Chap. 6, p 267-354.
93. Williams, E. A. In *The Chemistry of Organic Silicon Compounds*; Patai, S., Rappoport, Z., Eds.; Wiley: Chichester, U. K., 1989; Vol. 1, Part 1, Chap. 8, p 511-554.
94. Engelhardt, G.; Jancke, H. *Polym. Bull.* **1981**, *5*, 577-584.
95. Williams, E. A.; Cargioli, J. D. In *Annual Reports on NMR Spectroscopy*; Webb, G. A., Ed.; Academic: New York, 1979; Vol. 9, p 221-318.
96. Harris, R. K.; Kennedy, J. D.; McFarlane, W. In *NMR and the Periodic Table*; Harris, R. K., Mann, B. E., Eds.; Academic: London, 1978.
97. Blinka, T. A.; Helmer, B. J.; West, R. *Adv. Organomet. Chem.* **1984**, *23*, 193-218.
98. Macomber, R. S. *A Complete Introduction to Modern NMR Spectroscopy*; John Wiley and Sons: New York, 1998.
99. March, J. *Advanced Organic Chemistry: Reactions, Mechanisms, and Structure*; 4 ed.; Wiley: New York, 1992.
100. Bethell, D.; Gold, V. *Carbonium Ions: An Introduction*; Academic Press: London and New York, 1967.
101. Allen, A. D.; Charlton, J. C.; Eaborn, C.; Modena, G. *J. Chem. Soc.* **1957**, 3668-3670.
102. Allen, A. D.; Modena, G. *J. Chem. Soc.* **1957**, 3671-3678.
103. Schott, G.; Bondybey, V. *Chem. Ber.* **1967**, *100*, 1773-1777.
104. Kaufmann, K. D.; Ruhlmann, K. *Zh. Obshch. Khim.* **1967**, *7*, 391-392.
105. Schowen, R. L.; Latham, K. S. *J. Am. Chem. Soc.* **1967**, *89*, 4677-4683.
106. Corriu, R. J. P.; Royo, G. *J. Organomet. Chem.* **1968**, *14*, 291-307.
107. Corriu, R. J. P.; Royo, G. *Bull. Soc. Chim. Fr.* **1972**, 1490-1497.

108. Corriu, R. J. P.; Larcher, F.; Royo, G. *J. Organomet. Chem.* **1976**, *104*, 161-171.
109. Ottosson, C.-H.; Cremer, D. *Organometallics* **1996**, *15*, 5309-5320.
110. Maerker, C.; Kapp, J.; Schleyer, P. v. R. In *Organosilicon Chemistry II: From Molecules to Materials*; Auner, N., Weis, J., Eds.; VCH: Weinheim, 1996, p 329-359.
111. Eaborn, C.; Mahmoud, F. M. S. *J. Chem. Soc., Perkin Trans. 2* **1981**, 1309-1315.
112. Corriu, R. J. P.; Dabosi, G.; Martineau, M. *J. Organomet. Chem.* **1978**, *150*, 27-38.
113. Corriu, R. J. P.; Dabosi, G.; Martineau, M. *J. Organomet. Chem.* **1978**, *154*, 33-43.
114. Corriu, R. J. P.; Dabosi, G.; Martineau, M. *J. Organomet. Chem.* **1980**, *186*, 25-37.
115. Corriu, R. J. P.; Dabosi, G.; Martineau, M. *J. Chem. Soc., Chem. Commun.* **1979**, 457-458.
116. Krusic, P. J.; Fagan, P. J.; San Filippo, J. *J. Am. Chem. Soc.* **1977**, *99*, 250-252.
117. San Filippo, J.; Silbermann, J.; Fagan, P. J. *J. Am. Chem. Soc.* **1978**, *100*, 4834-4842.
118. Felkin, H.; Knowles, P. J.; Meunier, B. *J. Organomet. Chem.* **1978**, *146*, 151-167.
119. Corriu, R. J. P.; Henner, B. J. L. *J. Chem. Soc., Chem. Commun.* **1973**, 116-117.
120. Chauviere, G.; Corriu, R. J. P.; Henner, B. J. L. *J. Organomet. Chem.* **1975**, *86*, C1-C2.
121. Corriu, R. J. P.; Henner, B. J. L. *J. Organomet. Chem.* **1975**, *102*, 407-416.
122. Yoder, C. H.; Ryan, C. M.; Martin, G. F.; Ho, P. S. *J. Organomet. Chem.* **1980**, *190*, 1-7.
123. Macharashvili, A. A.; Shklover, V. E.; Struchkov, Y. T.; Oleneva, G. I.; Kramarova, E. P.; Shipov, A. G.; Baukov, Y. I. *J. Chem. Soc., Chem. Commun.* **1988**, 683-685.
124. Boer, F. P.; van Remoortere, F. P. *J. Am. Chem. Soc.* **1970**, *92*, 801-807.
125. Albanov, A. I.; Gubanov, L. I.; Larin, M. F.; Pestunovich, V. A.; Voronkov, M. G. *J. Organomet. Chem.* **1983**, *244*, 5-16.
126. Onan, K. D.; McPhail, A. T.; Yoder, C. H.; Hillyard, R. W. *J. Chem. Soc., Chem. Commun.* **1978**, 209-210.
127. Bassindale, A. R.; Borbaruah, M. *J. Chem. Soc., Chem. Commun.* **1991**, 1499-1501.
128. Bassindale, A. R.; Borbaruah, M. *J. Chem. Soc., Chem. Commun.* **1991**, 1501-1503.

129. Bassindale, A. R. In *Progress in Organosilicon Chemistry (Proceedings of the 10th International Symposium on Organosilicon Chemistry, Poznan, Poland, 1993)*; Marceniec, B., Chojnowski, J., Eds.; Gordon and Breach: Basel, 1995, p 191-207.
130. Sommer, L. H. *Stereochemistry, Mechanism, and Silicon*; McGraw Hill: New York, 1965.
131. Corey, E. J.; Snider, B. B. *J. Am. Chem. Soc.* **1972**, *94*, 2549-2550.
132. Corey, E. J.; Venkateswarlu, A. *J. Am. Chem. Soc.* **1972**, *94*, 6190-6191.
133. Furin, G. G.; Vyazankina, O. A.; Gostevsky, B. A.; Vyazankin, N. S. *Tetrahedron* **1988**, *44*, 2675-2749.
134. Corriu, R. J. P. In *Frontiers of Organosilicon Chemistry, Edinburgh, 1990*; Bassindale, A. R., Gaspar, P. P., Eds.; Royal Society of Chemistry: Cambridge, 1991, p 185-296.
135. Corriu, R. J. P.; Henner, B. J. L. *J. Organomet. Chem.* **1974**, *71*, 393-397.
136. Corriu, R. J. P.; Dabosi, G.; Martineau, M. *J. Chem. Soc., Chem. Commun.* **1977**, 649-650.
137. Carpino, L. A.; Sau, A. C. *J. Chem. Soc., Chem. Commun.* **1979**, 514-515.
138. Noyori, R.; Nishida, I.; Sakata, J. *J. Am. Chem. Soc.* **1981**, *103*, 2106-2108.
139. Nicolaou, K. C.; Reddy, K. R.; Skokotas, G.; Sato, F.; Xiao, X.-Y.; Hwang, K.-Y. *J. Am. Chem. Soc.* **1993**, *115*, 3558-3575.
140. Prakash, C.; Saleh, S.; Blair, I. A. *Tetrahedron Lett.* **1994**, *35*, 7565-7568.
141. Corey, E. J.; Yi, K. Y. *Tetrahedron Lett.* **1992**, *33*, 2289-2290.
142. Pilcher, A. S.; Hill, D. K.; Shimshock, S. J.; Waltermire, R. E.; Deshong, P. *J. Org. Chem.* **1992**, *57*, 2492-2495.
143. Gnann, R. Z.; Wagner, R. I.; Christe, K. O.; Bau, R.; Olah, G. A. *J. Am. Chem. Soc.* **1997**, *119*, 112-115.
144. Sharma, R. K.; Fry, J. L. *J. Org. Chem.* **1983**, *48*, 2112-2114.
145. Wetter, H.; Oertle, K. *Tetrahedron Lett.* **1984**, *26*, 5515-5518.
146. Cunico, R. F.; Bedell, L. *J. Org. Chem.* **1980**, *45*, 4797-4798.
147. Cook, F. L.; Bowers, C. W.; Liotta, C. L. *J. Org. Chem.* **1974**, *39*, 3416-3418.
148. Greene, T. W.; Wuts, P. G. *Protective Groups in Organic Synthesis*; John Wiley & Sons: New York, 1991.
149. Nelson, T. D.; Crouch, R. D. *Synthesis* **1996**, 1031-1069.
150. Kuwajima, I.; Nakamura, E. *J. Am. Chem. Soc.* **1975**, *97*, 3257-3258.
151. Kuwajima, I.; Nakamura, E.; Shimizu, M. *J. Am. Chem. Soc.* **1982**, *104*, 1025-1030.

152. Noyori, R.; Nishida, I.; Sakata, J. *Tetrahedron Lett.* **1980**, *21*, 2085-2088.
153. Noyori, R.; Nishida, I.; Sakata, J. *J. Am. Chem. Soc.* **1983**, *105*, 1598-1608.
154. Noyori, R.; Yokoyama, K.; Sakata, J.; Kuwajima, I.; Nakamura, E.; Shimizu, M. *J. Am. Chem. Soc.* **1977**, *99*, 1265-1267.
155. Nakamura, E.; Shimizu, M.; Kuwajima, I.; Sakata, J.; Yokoyama, K.; Noyori, R. *J. Org. Chem.* **1983**, *48*, 932-945.
156. Jefford, C. W.; Jaggi, D.; Boukouvalas, J. *Tetrahedron Lett.* **1987**, *28*, 4037-4040.
157. RajanBabu, T. V. *J. Org. Chem.* **1984**, *49*, 2083-2089.
158. RajanBabu, T. V.; Reddy, G. S.; Fukunaga, T. *J. Am. Chem. Soc.* **1985**, *107*, 5473-5483.
159. Corriu, R. J. P.; Young, J. C. In *The Chemistry of Organic Silicon Compounds*; Patai, S., Rappoport, Z., Eds.; Wiley: Chichester, UK, 1989; Vol. 1, Part 2, Chap. 20, p 1241-1288.
160. Corriu, R. J. P.; Perz, R.; Reye, C. *Tetrahedron* **1983**, *39*, 999-1009.
161. Sogah, D. Y.; Farnham, W. B. In *Organosilicon and Bioorganosilicon Chemistry*; Sakurai, H., Ed.; Ellis Horwood: Chichester, 1985.
162. Corriu, R. J. P.; Perz, R. *Tetrahedron Lett.* **1985**, *26*, 1311-1314.
163. Nakamura, E.; Yamago, S.; Machii, D.; Kuwajima, I. *Tetrahedron Lett.* **1988**, *29*, 2207-2210.
164. Shenvi, S.; Stille, J. K. *Tetrahedron Lett.* **1982**, *23*, 627-630.
165. Miura, K.; Nakagawa, S.; Suda, A.; Hosomi, A. *Chem. Lett.* **2000**, 150-151.
166. Shioiri, T.; Bohsako, A.; Ando, A. *Heterocycles* **1996**, *42*, 93-97.
167. Boyer, J.; Corriu, R. J. P.; Perz, R.; Reyé, C. *J. Chem. Soc., Chem. Commun.* **1981**, 122-123.
168. Fujita, M.; Hiyama, T. *J. Am. Chem. Soc.* **1984**, *106*, 4629-4630.
169. Deneux, M.; Akhrem, I. C.; Avetissian, D. V.; Myssoff, E. I.; Vol'pin, M. E. *Bull. Soc. Chim. Fr.* **1973**, 2638-2642.
170. Boyer, J.; Corriu, R. J. P.; Perz, R.; Reyé, C. *J. Organomet. Chem.* **1978**, *157*, 153-162.
171. Boyer, J.; Corriu, R. J. P.; Perz, R.; Reyé, C. *J. Organomet. Chem.* **1979**, *172*, 143-152.
172. Corriu, R. J. P.; Guerin, C.; Henner, B.; Wang, Q. J. *Organometallics* **1991**, *10*, 2297-2303.
173. Chérest, M.; Felkin, H.; Prudent, N. *Tetrahedron Lett.* **1968**, 2199-2204.

174. Anh, N. T.; Eisenstein, O. *Nouv. J. Chim.* **1977**, *1*, 61-70.
175. Schinzer, D. In *Organic Syntheses. Highlights II*; Waldman, H., Ed.; VCH: New York, 1995, p 123-127.
176. Fujita, M.; Hiyama, T. *J. Org. Chem.* **1988**, *53*, 5405-5415.
177. Hosomi, A.; Shirahata, A.; Sakurai, H. *Tetrahedron Lett.* **1978**, 3043-3046.
178. Degl' Innocenti, A.; Pike, S.; Walton, D. R. M.; Seconi, G.; Ricci, A.; Fiorenza, M. *J. Chem. Soc., Chem. Commun.* **1980**, 1201-1202.
179. Nakamura, E.; Kuwajima, I. *Angew. Chem., Int. Ed. Engl.* **1976**, *15*, 498-499.
180. Holmes, A. B.; Jenningswhite, C. L. D.; Schulthess, A. H.; Akinde, B.; Walton, D. R. M. *J. Chem. Soc., Chem. Commun.* **1979**, 840-842.
181. Pornet, J.; Randrianoelina, B. *Tetrahedron Lett.* **1981**, *22*, 1327-1328.
182. Pornet, J. *Tetrahedron Lett.* **1981**, *22*, 455-456.
183. Ricci, A.; Degl' Innocenti, A.; Fiorenza, M.; Taddei, M.; Spartera, M. A.; Walton, D. R. M. *Tetrahedron Lett.* **1982**, *23*, 577-578.
184. Effenberger, F.; Spiegler, W. *Angew. Chem., Int. Ed. Engl.* **1981**, *20*, 265-266.
185. Chan, T. H.; Lau, P. W. K.; Li, M. P. *Tetrahedron Lett.* **1976**, 2667-2670.
186. Majetich, G.; Casares, A.; Chapman, D.; Behnke, M. *J. Org. Chem.* **1986**, *51*, 1745-1753.
187. Schwesinger, R.; Link, R.; Thiele, G.; Rotter, H.; Honert, D.; Limbach, H. H.; Mänle, F. *Angew. Chem., Int. Ed. Engl.* **1991**, *30*, 1372-1375.
188. Kira, M.; Hino, T.; Sakurai, H. *Tetrahedron Lett.* **1989**, *30*, 1099-1102.
189. Loezos, P.; Pilcher, A. S.; DeShong, P. Unpublished results.
190. Brown, B. R. *The Organic Chemistry of Aliphatic Nitrogen Compounds*; Oxford University Press: New York, 1994; Vol. 28.
191. Fleming, F. F. *Nat. Prod. Rep.* **1999**, *16*, 597-606.
192. Soli, E. D. Doctoral Dissertation, University of Maryland, College Park, 1999.
193. Larock, R. C. *Comprehensive Organic Transformations: A Guide to Functional Group Preparations*; VCH Publishers, Inc.: New York, 1989.
194. Shimizu, S.; Kito, K.; Sasaki, Y.; Hirai, C. *Chem. Commun.* **1997**, 1629-1630.
195. Mizuno, A.; Hamada, Y.; Shioiri, T. *Synthesis* **1980**, 1007-1008.
196. Thoman, C. J.; Habeeb, T. D.; Huhn, M.; Korpusik, M.; Sliso, D. F. *J. Org. Chem.* **1989**, *54*, 4476-4478.

197. Little is known about the biological activity of crown ethers, but limited oral toxicological studies demonstrate CNS effects. *Aldrich Technical Bulletin AL-115*; Aldrich Chemical Company, Inc.: Milwaukee, WI.
198. Leong, B. K. J. *Chem. Eng. News* **1975**, 53, 5-5.
199. Hendrixson, R. R.; Mack, M. P.; Palmer, R. A.; Ottolenghi, A.; Ghirardelli, R. G. *Toxicol. Appl. Pharmacol.* **1978**, 44, 263-268.
200. Mohora, M.; Olinescu, R.; Mihailescu, I.; Dinu, V.; Luca, C. *Rom. J. Biophys.* **1993**, 3, 53-60.
201. Saito, K.; Harada, K. *Bull. Chem. Soc. Jpn.* **1989**, 62, 2562-2566.
202. Harrison, C. R.; Hodge, P. *Synthesis* **1980**, 299-301.
203. Regen, S. L.; Quici, S.; Liaw, S.-J. *J. Org. Chem.* **1979**, 44, 2029-2030.
204. Ando, A.; Kawate, T.; Ichihara, J.; Hanafusa, T. *Chem. Lett.* **1984**, 725-728.
205. Bram, G.; Fillebeen-Khan, T.; Geraghty, N. *Synth. Commun.* **1980**, 10, 279-289.
206. Bram, G.; Loupy, A.; Pedoussaut, M. *Bull. Soc. Chim. Fr.* **1985**, 124-128.
207. Matsubara, K.; Mukaiyama, T. *Chem. Lett.* **1994**, 247-250.
208. Meinjohanns, E.; Meldal, M.; Paulsen, H.; Bock, K. J. *J. Chem. Soc., Perkin Trans. 1* **1995**, 405-415.
209. Shaw, J. E.; Hsia, D. Y.; Parries, G. S.; Sawyer, T. K. *J. Org. Chem.* **1978**, 43, 1017-1018.
210. Ogawa, T.; Nakabayashi, S.; Shibata, S. *Agric. Biol. Chem.* **1983**, 47, 281-285.
211. Takeda, T.; Sugiura, Y.; Ogihara, Y.; Shibata, S. *Can. J. Chem.* **1980**, 58, 2600-2603.
212. White, D. A.; Baizer, M. M. *J. Chem. Soc., Perkin Trans. 1* **1973**, 2230-2236.
213. Hudlicky, T.; Edoma, M. A.; Butora, G. *J. Chem. Soc., Perkin Trans. 1* **1996**, 17, 2187-2192.
214. Ito, M.; Koyakumaru, K.-i.; Ohta, T.; Takaya, H. *Synthesis* **1995**, 4, 376-378.
215. Harusawa, S.; Yoneda, R.; Omori, Y.; Kurihara, T. *Tetrahedron Lett.* **1987**, 28, 4189-4190.
216. Friedman, L.; Shechter, H. *J. Org. Chem.* **1960**, 25, 877-879.
217. Bram, G.; Loupy, A.; Pedoussaut, M. *Bull. Soc. Chim. Fr.* **1986**, 467-475.
218. Pouchert, C. J.; Behnke, J. *The Aldrich Library of ¹³C and ¹H FT NMR Spectra*; 1st ed.; The Aldrich Chemical Company, Inc.: Milwaukee, 1993; Vol. 1.
219. Grutzner, J. B.; Jautelat, M.; Dence, J. B.; Smith, R. A.; Roberts, J. D. *J. Am. Chem. Soc.* **1970**, 92, 7107-7120.

220. Okimoto, M.; Chiba, T. *J. Org. Chem.* **1990**, *55*, 1070-1076.
221. Black, T. H. *Org. Prep. Proced. Int.* **1989**, *21*, 179-217.
222. Carretero, J. C.; Ruano, J. L. G. *Tetrahedron Lett.* **1985**, *26*, 3381-3384.
223. Dixon, D. A.; Hertler, W. R.; Chase, D. B.; Farnham, W. B.; Davidson, F. *Inorg. Chem.* **1988**, *27*, 4012-4018.
224. Handy, C. J. Doctoral Dissertation, University of Maryland, College Park, 2002.
225. Walz, A. J.; Miller, M. J. *Org. Lett.* **2002**, *4*, 2047-2050.
226. van Ameijde, J.; Albada, H. B.; Liskamp, R. M. J. *J. Chem. Soc., Perkin Trans. 1* **2002**, 1042-1049.
227. Aggarwal, V. K.; Alonso, E.; Ferrara, M.; Spey, S. E. *J. Org. Chem.* **2002**, *67*, 2335-2344.
228. Adachi, H.; Nishimura, Y.; Takeuchi, T. *J. Antibiot.* **2002**, *55*, 92-98.
229. Schweizer, F. *Angew. Chem., Int. Ed. Engl.* **2001**, *41*, 230-253.
230. Sambaiah, T.; Fanwick, P. E.; Cushman, M. *Synthesis* **2001**, 1450-1452.
231. Suzuki, T.; Tanaka, S.; Yamada, I.; Koashi, Y.; Yamada, K.; Chida, N. *Org. Lett.* **2000**, *2*, 1137-1140.
232. Hager, C.; Miethchen, R.; Reinke, H. *J. Carbohydr. Chem.* **2000**, *19*, 997-1018.
233. Fraser-Reid, B.; Anilkumar, G.; Nair, L. G.; Olsson, L.; Martin, M. G.; Daniels, J. K. *Isr. J. Chem.* **2000**, *40*, 255-262.
234. Wu, J.; Hou, X.-L.; Dai, L.-X. *J. Org. Chem.* **2000**, *65*, 1344-1348.
235. Bhat, A. S.; Gervay-Hague, J. *Org. Lett.* **2001**, *3*, 2081-2084.
236. Quadrelli, A.; Poli, R. Unpublished results.
237. Prakash, G. K. S.; Mandal, M. *J. Am. Chem. Soc.* **2002**, *124*, 6538-6539.
238. Prakash, G. K. S.; Mandal, M.; Olah, G. A. *Angew. Chem., Int. Ed. Engl.* **2001**, *40*, 589-590.
239. Nawrot, B.; Michalak, O.; Olejniczak, S.; Wieczorek, M. W.; Lis, T.; Stec, W. J. *Tetrahedron* **2001**, *57*, 3979-3985.
240. Bainbridge, J. M.; Corr, S.; Kanai, M.; Percy, J. M. *Tetrahedron Lett.* **2000**, *41*, 971-974.
241. Lipshutz, B. H.; Chrisman, W.; Noson, K.; Papa, P.; Sclafani, J. A.; Vivian, R. W.; Keith, J. M. *Tetrahedron* **2000**, *56*, 2779-2788.
242. Suzuki, T.; Suzuki, S. T.; Yamada, I.; Koashi, Y.; Yamada, K.; Chida, N. *J. Org. Chem.* **2002**, *67*, 2874-2880.

243. Damkaci, F.; DeShong, P. *J. Org. Chem.* **2003**, *125*, 4408-4409.
244. Still, W. C.; Kahn, M.; Mitra, A. *J. Org. Chem.* **1978**, *42*, 2923-2924.
245. Perrin, D. D.; Armarego, W. L. F.; Perrin, D. R. *Purification of Laboratory Chemicals*; 2 ed.; Pergamon: New York, 1980.
246. Olah, G. A.; Narang, S. C.; Balaram Gupta, B. G.; Malhotra, R. *J. Org. Chem.* **1979**, *44*, 1247-1251.
247. Schleyer, P. v. R. In *Reagents for Organic Synthesis*; Fieser, L. F., Fieser, M., Eds.; John Wiley and Sons: New York, 1967; Vol. 1, p 1179-1184.
248. Wawzonek, S.; Klimstra, P. D.; Kallio, R. E. *J. Org. Chem.* **1960**, *25*, 621-623.
249. Pouchert, C. J. *The Aldrich Library of FT-IR Spectra*; 1st ed.; Aldrich Chemical Company, Inc.: Milwaukee, 1985; Vol. 1.
250. Pouchert, C. J. *The Aldrich Library of Infrared Spectra*; 3rd ed.; Aldrich Chemical Company, Inc.: Milwaukee, 1981.
251. Otera, J.; Nakazawa, K.; Sekoguchi, K.; Orita, A. *Tetrahedron* **1997**, *53*, 13633-13640.
252. Freerksen, R. W.; Selikson, S. J.; Wroble, R. R. *J. Org. Chem.* **1983**, *48*, 4087-4096.